

# Keysight Technologies B1505A Power Device Analyzer / Curve Tracer

# Notices

## Copyright Notice

© Keysight Technologies 2009-2016

No part of this manual may be reproduced in any form or by any means (including electronic storage and retrieval or translation into a foreign language) without prior agreement and written consent from Keysight Technologies as governed by United States and international copyright laws.

## Manual Part Number

B1505-90000

## Edition

Edition 1, June 2009  
Edition 2, November 2009  
Edition 3, June 2010  
Edition 4, August 2010  
Edition 5, June 2011  
Edition 6, June 2012  
Edition 7, September 2012  
Edition 8, November 2012  
Edition 9, October 2013  
Edition 10, May 2015  
Edition 11, September 2015  
Edition 12, January 2016

## Printed in:

Printed in Malaysia

## Published by:

Keysight Technologies International Japan  
G.K.  
9-1, Takakura-cho, Hachioji-shi, Tokyo  
192-0033 Japan

## Technology Licenses

The hardware and/or software described in this document are furnished under a license and may be used or copied only in accordance with the terms of such license.

## Declaration of Conformity

Declarations of Conformity for this product and for other Keysight products may be

downloaded from the Web.

## U.S. Government Rights

The Software is "commercial computer software," as defined by Federal Acquisition Regulation ("FAR") 2.101. Pursuant to FAR 12.212 and 27.405-3 and Department of Defense FAR Supplement ("DFARS") 227.7202, the U.S. government acquires commercial computer software under the same terms by which the software is customarily provided to the public. Accordingly, Keysight provides the Software to U.S. government customers under its standard commercial license, which is embodied in its End User License Agreement (EULA). The license set forth in the EULA represents the exclusive authority by which the U.S. government may use, modify, distribute, or disclose the Software. The EULA and the license set forth therein, does not require or permit, among other things, that Keysight: (1) Furnish technical information related to commercial computer software or commercial computer software documentation that is not customarily provided to the public; or (2) Relinquish to, or otherwise provide, the government rights in excess of these rights customarily provided to the public to use, modify, reproduce, release, perform, display, or disclose commercial computer software or commercial computer software documentation. No additional government requirements beyond those set forth in the EULA shall apply, except to the extent that those terms, rights, or licenses are explicitly required from all providers of commercial computer software pursuant to the FAR and the DFARS and are set forth specifically in writing elsewhere in the EULA. Keysight shall be under no obligation to update, revise or otherwise modify the Software. With respect to any technical data as defined by FAR 2.101, pursuant to FAR 12.211 and 27.404.2 and DFARS 227.7102, the U.S. government acquires no greater than Limited

Rights as defined in FAR 27.401 or DFAR 227.7103-5 (c), as applicable in any technical data.

## Warranty

THE MATERIAL CONTAINED IN THIS DOCUMENT IS PROVIDED "AS IS," AND IS SUBJECT TO BEING CHANGED, WITHOUT NOTICE, IN FUTURE EDITIONS. FURTHER, TO THE MAXIMUM EXTENT PERMITTED BY APPLICABLE LAW, KEYSIGHT DISCLAIMS ALL WARRANTIES, EITHER EXPRESS OR IMPLIED, WITH REGARD TO THIS MANUAL AND ANY INFORMATION CONTAINED HEREIN, INCLUDING BUT NOT LIMITED TO THE IMPLIED WARRANTIES OF MERCHANTABILITY AND FITNESS FOR A PARTICULAR PURPOSE. KEYSIGHT SHALL NOT BE LIABLE FOR ERRORS OR FOR INCIDENTAL OR CONSEQUENTIAL DAMAGES IN CONNECTION WITH THE FURNISHING, USE, OR PERFORMANCE OF THIS DOCUMENT OR OF ANY INFORMATION CONTAINED HEREIN. SHOULD KEYSIGHT AND THE USER HAVE A SEPARATE WRITTEN AGREEMENT WITH WARRANTY TERMS COVERING THE MATERIAL IN THIS DOCUMENT THAT CONFLICT WITH THESE TERMS, THE WARRANTY TERMS IN THE SEPARATE AGREEMENT SHALL CONTROL.

NOTICE: This document contains references to Agilent Technologies. Agilent's former Test and Measurement business has become Keysight Technologies. For more information, go to [www.keysight.com](http://www.keysight.com).



## COMPLIANCE WITH GERMAN NOISE REQUIREMENTS

This is to declare that this product is in conformance with the German Regulation on Noise Declaration for Machines (Lärmangabe nach der Maschinenlärminformation-Verordnung -3.GSGV Deutschland).

- Herstellerbescheinigung

### GERÄUSCHEMISSION

Lpa < 70 dB

am Arbeitsplatz

normaler Betrieb

nach DIN 45635 T. 19

- Manufacturer's Declaration

### ACOUSTIC NOISE EMISSION

Lpa < 70dB

operator position

normal operation

per ISO 7779

## South Korean Class A EMC declaration

This equipment is Class A suitable for professional use and is for use in electromagnetic environments outside of the home.

### A급 기기

(업무용 방송통신기자재)

이 기기는 업무용(A급) 전자파적합기기로서 판매자 또는 사용자는 이 점을 주의하시기 바라며, 가정외의 지역에서 사용하는 것을 목적으로 합니다.

## WARNING



### High Voltage

is used in the operation of this equipment.

### LETHAL VOLTAGE on CONTACT

may be present at measurement terminals,  
if you fail to take in all safety precautions!

- When the RED indicator lights, lethal voltage ( $\pm 10$  kV dc/pulse) may appear at measurement terminals.
- **Usually use the interlock function.**
- Do not operate the instrument unless another person is around the work space who is familiar with instrument operation and hazards or administering first aid.
- Potentials less than  $\pm 500$  V may cause death under certain conditions. Therefore, adequate preventive measures must be taken at all times!

#### FIRST AID FOR ELECTRIC SHOCK

##### ***SPECIAL ATTENTION TO RESCUE IN SAFETY***

- Never rush into an accidental situation.
- Take special attention to the following notices to prevent second accident.
  - Do NOT touch the CASUALTY or conductive surface with your hands unprotected.
  - Shut off high voltage at once.
  - Disconnect AC mains.
- If it is unsure to make safe, the following procedure will help to protect your lives during the CASUALTY is rescued.
  - Stand on a dry insulating material; use a dry wooden or plastic implement to free the CASUALTY from contact with hazardous electrical source.
  - Ground the circuit to de-energize.

- Free the CASUALTY from the LIVE conductor

### CALL EMERGENCY

- Call your local Emergency number immediately, if any of signs or symptoms shown in the following table will be found.

[http://en.wikipedia.org/wiki/Emergency\\_telephone\\_number#Emergency\\_numbers](http://en.wikipedia.org/wiki/Emergency_telephone_number#Emergency_numbers)

### DELAYED SYMPTOMS

- In some cases, electric shock can cause injuries that are not evident and symptoms may be delayed.
- Burns to the CASUALTY may be greater than they appear on the surface.
- For these reasons, all electric shock CASUALTY should be taken to hospital for advanced observation.

English	Deutsch	French	Japanese	Korean	Simplified Chinese	Traditional Chinese
Symptoms	Symptome	Symptômes	兆候	징후	征候	徵候
Cardiac arrest	Herz-Kreislauf-Stillstand	Arestation cardiopulmonaire	心肺停止	심폐 정지	心肺停止	心肺停止
Abnormal cardiac rhythm	Arrhythmia	Arythmie	不整脈	부정맥	脉律不齐	脈律不齊
Respiratory failure (difficult or absent breathing)	Respiratorischer Mißerfolg	Échec respiratoire	呼吸不全	호흡 부전	呼吸不全	呼吸不全
Muscle pain and contractions	Muskelschmerz und Zusammenziehungen	Douleur du muscle et contractions	筋肉痛 / 痙攣	근육통 / 수축	肌肉痛 / 痙攣	肌肉痛 / 痙攣
Seizures (heart beat stopped)	Herzlähmung	Paralysie cardiaque	心臟麻痺	심장 마비	心脏麻痹	心臟麻痺
Numbness and tingling	Eine Taubheit / Stachel	Un engourdissement / Une épine	痺れ / 刺痛	저리다 / 가시痛	发麻 / 刺痛	發麻 / 刺痛
Unconsciousness	Bewusstlosigkeit	Évanouissement	意識不明	의식 불명	意识不明	意識不明
Entrance and exit wound burns	Eine elektrische Schockspur	Une trace du choc électrique	感電跡	감전 자국	触电痕迹	觸電痕跡

## First Aid for Electric Shock Procedure

Do not give compression-only CPR to infants and children – all infants and children who have a sudden cardiac arrest need conventional CPR. Also should not be used for adults whose cardiac arrest is from respiratory causes, or for an unwitnessed cardiac arrest.

D	Danger	Check for DANGER, make SAFE first to YOU, Others, and the CASUALTY.	
R	Response	Check for a RESPONSE.	
		Leave on back. If not conscious, <ol style="list-style-type: none"> <li>1. Ask others to emergency CALL for an ambulance immediately.</li> <li>2. HELP to bring AED, ASAP.</li> <li>3. Start CPR by YOU.</li> </ol>	
C	CPR for ADULT only	Start the center of chest compressions (>100 compressions per minute) without stopping until emergency medical services arrive .	
		One of the most famous chest compression-only CPR is AHA Hands-Only CPR which is without mouth-to-mouth rescue breaths.	
		Continue CPR until <ul style="list-style-type: none"> <li>● Signs of life return.</li> <li>● AED is ready to use.</li> <li>● Medical services arrive and take over.</li> </ul>	
If YOU have a trained rescue skill, should apply the following step. If not, only keep chest compression until others help.			
A	Airway	<b>No foreign material</b> Leave on back, open airway.	<b>Foreign material</b> Place in the recovery position, clear of objects.
B	Breathing	30 compress & 2 breaths	
D	Defibrillator 	Apply AED with following voice prompts. If no AED available, continue CPR until qualified personnel arrives.	

※AED: Automated External Defibrillator

※CPR: Cardio Pulmonary Resuscitation

※AHA: American Heart Association, Inc.





---

## Safety Summary

The following general safety precautions must be observed during all phases of operation, service, and repair of this instrument. Failure to comply with these precautions or with specific warnings elsewhere in this manual may impair the protections provided by the instrument. In addition, it violates safety standards of design, manufacture, and intended use of the instrument. Keysight Technologies, Inc. assumes no liability for customer's failure to comply with these requirements.

Product manuals may be provided on CD-ROM or in printed form. Printed manuals are an option for many products. Manuals may also be available on the Web.

---

### NOTE

Do not use this instrument in any manner not specified by the manufacturer. The protective features of this instrument may be impaired if it is used in a manner not specified in the operation instructions.

This instrument is an INDOOR USE product.

This instrument complies with INSTALLATION CATEGORY II for mains input and INSTALLATION CATEGORY I for measurement input terminals, and POLLUTION DEGREE 2 defined in IEC 61010-1.

If an instrument is marked CAT I (IEC Measurement Category I), or it is not marked with a measurement category, its measurement terminals must not be connected to line-voltage mains.

Safety of any system incorporating the equipment is the responsibility of the assembler of the system.

---

### WARNING

Hazardous voltage, instrument maximum output voltage may appear at the measurement terminals (High, Force, Guard, and Sense) if Interlock terminal is closed. Open the Interlock terminal when the measurement terminals are accessible. Voltage applied to the terminals will be limited up to  $\pm 42$  V.

Do not work the interlock function intentionally in order to bring the output voltage to the safe level. While the high voltage indicator is lit, the dangerous voltage by the output voltage or the residual charge appears on the measurement terminal.

---

- *DANGEROUS PROCEDURE WARNINGS*

Warnings, such as WARNING on the previous page, shall be complied. Procedures throughout in this manual prevent you from potentially hazard. Their instructions contained in the warnings must be followed.

- *BEFORE APPLYING POWER*

Verify that all safety precautions are taken. Make all connections to the instrument before applying power. Note the instrument's external markings described under "Safety Symbols".

- *GROUND THE INSTRUMENT*

This is Safety Class I instrument. To minimize shock hazard, the instrument chassis and cabinet must be connected to an electrical ground. The power terminal and the power cable must meet International Electrotechnical Commission (IEC) safety standards.

- *DO NOT OPERATE IN AN EXPLOSIVE ATMOSPHERE*

Do not operate the instrument in the presence of flammable gases or fumes. Operation of any electrical instrument in such an environment constitutes a definite safety hazard.

- *DO NOT REMOVE COVERS*

No operator serviceable parts inside. Refer servicing to qualified personnel. To prevent electrical shock do not remove covers.

- *IN CASE OF DAMAGE*

Instruments that appear damaged or defective should be made inoperative and secured against unintended operation until they can be repaired by qualified service personnel. Return the instrument to a Keysight Technologies sales or service office for services and repair to ensure that safety features are maintained.

















- *USE ONLY THE SPECIFIC ACCESSORIES*

Specific accessories satisfy the requirements for specific characteristics for using the instrument. Use the specific accessories, cables, adapters, and so on for safety reasons.

---

## Safety Symbols

The general definitions of safety symbols used on equipment or in manuals are listed below.

-  Direct current.
-  Alternating current.
-  Earth ground terminal.
-  Protective conductor terminal. For protection against electrical shock in case of a fault. Used with field wiring terminals to indicate the terminal which must be connected to ground before operating equipment.
-  Frame or chassis terminal. A connection to the frame (chassis) of the equipment which normally includes all exposed metal structures.
-  Grounded terminal which indicates the earth potential.
-  On supply.
-  Off supply.
-  Standby supply. The equipment will be marked with this symbol is not completely disconnected from AC mains when power switch is in the standby position.
-  In position of a bi-stable push switch.
-  Out position of a bi-stable push switch.
-  Hazardous voltage and potential for electrical shock. Do not touch terminals that have this symbol when the equipment is on.
-  Hot surface. Avoid contact. Surfaces are hot and may cause personal injury if touched.
-  Low temperature or freezing conditions. Avoid contact. Surfaces are cold and may cause personal injury if touched.
-  Caution, refer to accompanying documentation. The equipment will be marked with this symbol when it is necessary for the user to refer to the instruction manual.
-  Read operator's manual. To indicate that the operator's manual or card should be read before continuing the operation.

**CAT I** IEC Measurement Category I



The CE mark shows that the product complies with all applicable European Directives.



The CSA mark is a registered trademark of the Canadian Standards Association.



The RCM mark is a registered trademark of the Australian Communications Authority. This signifies compliance with the Australian EMC Framework Regulations under the terms of the Radio communications Act.

**ICES/NMB-001**

This ISM device complies with Canadian ICES-001.  
Cet appareil ISM est conforme à la norme NMB-001 du Canada.

**ISM GROUP 1 CLASS A**

This is the symbol for an Industrial, Scientific and Medical, Group 1 Class A product. (CISPR 11)



Korea's safety and EMC mark



China RoHS - Environmentally Green Product Label



China RoHS - Product with Toxic Substance 40 yr EPUP



The Chinese mark for paper-based packaging materials; Paperboard and Corrugated Fiberboard



Plastic Material Coding Identification

---

**WARNING**

A WARNING notice denotes a hazard. It calls attention to an operating procedure, practice, or the like that, if not correctly performed or adhered to, could result in personal injury or death. Do not proceed beyond a WARNING notice until the indicated conditions are fully understood and met.

---

**CAUTION**

A CAUTION notice denotes a hazard. It calls attention to an operating procedure, practice, or the like that, if not correctly performed or adhered to, could result in damage to the product or loss of important data. Do not proceed beyond a CAUTION notice until the indicated conditions are fully understood and met.

---

---

## Power Supply and Measurement Safety

- Power Supply Safety

This instrument can output high currents and voltages. Make sure that the load or device under test can safely handle the output current and voltage. Also, make sure that the connection leads can safely withstand the expected currents and are insulated for the expected voltages.

The instrument outputs may be connected so as to float relative to earth ground. Isolation or floating voltage ratings are indicated on the instrument, near the output terminal or the Circuit Common terminal. There is the danger of electric shock by touching the floated measurement terminals. Keep in mind it to protect yourself. And it is a reason of using the recommended accessories.

- Voltage/Current Measurement Safety

Multimeters and other instruments capable of measuring high voltages and currents are subject to specific safety concerns because of the circuits to which they may be connected. To safely use these instruments, you need to understand the markings on the instrument near the input terminals, which include the Protection Limits and the IEC Measurement Category.

- Protection Limits

Keysight multimeters and other voltage measurement instruments provide protection circuitry to prevent damage to the instrument and to protect against the danger of electric shock, provided the Protection Limits are not exceeded. To ensure safe operation of the instrument, do not exceed the Protection Limits shown on the input terminals.

- Source/Monitor Terminals

Source/monitor unit, SMU, can simultaneously perform DC voltage or current output and measurement. Typical SMU has the Force, Guard, Sense, and Circuit Common terminals as shown below. Normally the Force, Guard, and Sense terminals are the same potential. Voltage marked around the terminals indicates the Protection Limits.

Force and Sense must be connected to a terminal of a device under test for the Kelvin connection which is effective for high current measurement and low resistance measurement. For the non-Kelvin connection to ease the connections, connect Force only. Do not connect Sense. It must be opened.

Guard should be extended to around the device terminal for reducing leakage current caused by a coaxial cable used. Guard must be never connected to anything at the device side.

Circuit Common should be connected to shielding of the coaxial cable used.

The following image is the Kelvin triaxial connector of High Power SMU.

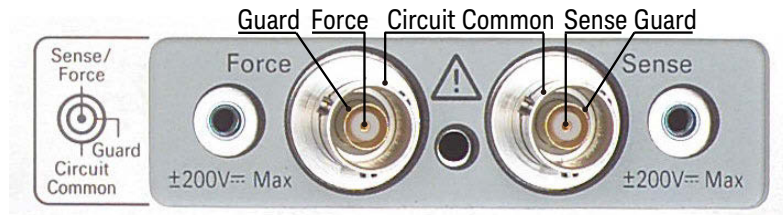

- To Avoid Risk of Residual Charge

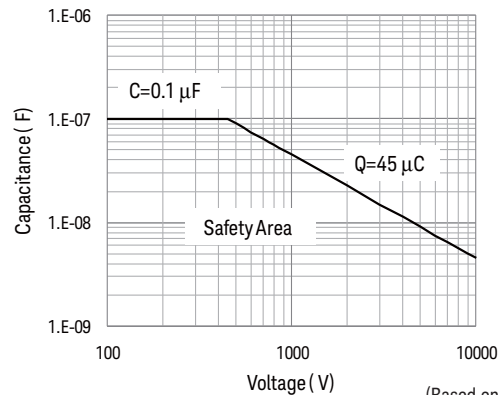

(Based on standards IEC60950-1 and IEC61010-1.)

This graph shows the load capacitance vs voltage characteristics generally considered as safety. Use the instrument within the safety area up to 0.1  $\mu\text{F}$  or 45  $\mu\text{C}$  according to the voltage. Also do not connect the capacitive load over the maximum load capacitance specified for the instrument, for example 10 nF for HVSMU and 5 nF for UHVU.

Before touching the measurement terminal, confirm that it has been discharged enough. For that, ground and discharge the terminals over 10 seconds after stopping the high voltage output, and confirm that they have been safety voltage by using another volt meter.

If abnormal end of measurement, breaking of cable, or device damage occurs, do not touch the terminals until they are discharged enough.

Also if a series resistor such as N1262A-020, N1262A-021, and N1262A-023 is connected, do not touch the terminal until it is discharged enough.



### High Voltage Shock Hazard

Keysight B1505A can force dangerous voltages ( $\pm 10$  kVdc for UHVU,  $\pm 3000$  Vdc for HVSMU,  $\pm 2200$  Vpulse for HVMCU,  $\pm 200$  Vdc for HPSMU, and  $\pm 100$  Vdc for MPSMU) at the High, Force, Guard, and Sense terminals. To prevent electric shock hazard, the following safety precautions must be observed during the use of Keysight B1505A.

- Connect the instrument to an electrical ground (safety ground) by using three-conductor AC power cable.
- Before performing measurement, connect the interlock circuit to the Interlock terminal of this instrument.
- Confirm periodically that the interlock function works normally.
- Before touching the connections of the High, Force, Guard, and Sense terminals, turn the instrument off and discharge any capacitors of the measurement path. If you do not turn the instrument off, complete “all” of the following items, regardless of any instrument settings.
  - Terminate measurement by pressing the Stop key, confirm that the Measurement status indicator is not lit.
  - Confirm that the High Voltage indicator is not lit.
  - Open the shielding box access door (open the Interlock terminal).
  - Discharge any capacitors if the capacitance is connected to an SMU.
- Warn workers in the vicinity of the instrument about hazardous conditions.



### Gefahr durch Hochspannung

Von den Geräten Keysight B1505A können Spannungen an den Anschlüssen "High", "Force", "Guard" und "Sense" von bis zu 10 kV ausgehen. Um elektrischem Schlag vorzubeugen, ist bei der Benützung der Geräte Keysight B1505A folgendes zu beachten.

- Verwenden Sie ein dreiphasiges AC-Stromkabel für die Gerätsteckvorrichtung (Eingang) und schließen Sie das Instrument an eine Erdung an (Sicherheitserdung).
- Vor der Messung verbinden Sie den Verriegelungsstromkreis mit dem Interlock-Anschluss dieses Instruments.
- Prüfen Sie in regelmäßigen Abständen, dass die Verriegelungsfunktion ordnungsgemäß funktioniert.
- Bevor Sie die Verbindungen zu den Anschlüssen "High", "Force", "Guard" und "Sense" berühren, schalten Sie das Instrument aus und entladen alle Kondensatoren des Messwegs. Wenn Sie das Instrument nicht ausschalten, führen Sie, unabhängig von den Instrumenteinstellungen, alle folgenden Schritte durch.
  - Beenden Sie die Messung, indem Sie auf die Taste "Stop" drücken. Stellen Sie sicher, dass die Statusanzeige "Measurement" nicht leuchtet.
  - Stellen Sie sicher, dass die Anzeige "High Voltage" nicht leuchtet.
  - Öffnen Sie die Tür des Abschirmungsgehäuses (öffnen des Interlock-Anschlusses).
  - Entladen Sie alle Kondensatoren, wenn die Kapazität mit einer SMU verbunden ist.
- Warnen Sie Mitarbeiter in der Umgebung des Instruments vor den Gefahren.





### Danger de choc dû à une haute tension

Une tension dangereuse (max.  $\pm$  pour UHVU; 10 kVdc, max.  $\pm$  pour HVSMU; 3000 Vdc, max.  $\pm$  pour HVMCU; 2200 Vpulse, max.  $\pm$  pour HPSMU; 200 Vdc, max.  $\pm$  pour MPSMU; 100 Vdc) émanant du dispositif Keysight B1505A peut être sortie aux bornes High, Force, Guard et Sense. Les précautions suivantes doivent être observées contre commotion électrique accidentelle.

- Utilisez un câble d'alimentation CA à trois conducteurs vers le coupleur secteur (entrée) et branchez l'instrument sur une mise électrique à la terre (prise de terre de sécurité).
- Avant de procéder aux mesures, connectez le circuit de sécurité à la borne Interlock de l'instrument.
- Vérifiez régulièrement le bon fonctionnement de la fonction de sécurité.
- Avant de toucher les connexions des bornes High, Force, Guard et Sense, mettez l'instrument hors tension et déchargez tout condensateur du chemin de mesure. Si vous ne mettez pas l'instrument hors tension, effectuez « toutes » les opérations ci-dessous, quels que soient les paramètres de l'instrument.
  - Terminez les mesures en appuyant sur la touche Stop ; vérifiez que l'indicateur d'état Measurement est éteint.
  - Vérifiez que le témoin High Voltage est éteint.
  - Ouvrez la trappe d'accès au boîtier de protection (ouvrez la borne Interlock).
  - Déchargez les éventuels condensateurs si la capacité est connectée à une unité SMU.
- Informez les personnes travaillant à proximité de l'instrument des conditions.



## 高電圧感電注意

Keysight B1505A の High、Force、Guard、Sense 端子には、危険電圧が出力されることがあります（UHVU の場合は最大  $\pm 10$  kVdc、HVSMU の場合は最大  $\pm 3000$  Vdc、HVMCU の場合は最大  $\pm 2200$  Vpulse、HPSMU の場合は最大  $\pm 200$  Vdc、MPSMU の場合は最大  $\pm 100$  Vdc）。感電事故防止のため、Keysight B1505A の使用時には必ず以下の事柄を守ってください。

- 3 極電源ケーブルを使用して本器を接地してください。
- 測定を開始する前にはインターロック回路を本器の Interlock 端子に接続してください。
- インターロック機能が正常であることを定期的を確認してください。
- High、Force、Guard、Sense 端子に繋がる接続部に触れる前には、本器の電源を切断してください。また、測定系のキャパシタを放電してください。電源を切らない場合は、以下の事項を全て実施してください。
  - Stop キーを押して Measurement インジケータが消灯したことを確認してください。
  - 高電圧警告 (High Voltage) インジケータが消灯していることを確認してください。
  - シールド・ボックスのドアを開けてください (Interlock 端子を開放してください)。
  - キャパシタが SMU に接続されているならば、キャパシタを放電してください。
- 周囲のほかの作業者に対しても、高電圧危険に対する注意を徹底してください。

---

## Product Stewardship



- Waste Electrical and Electronic Equipment (WEEE) Directive 2002/96/EC

This product complies with the WEEE Directive (2002/96/EC) marking requirements. The affixed label indicates that you must not discard this electrical/ electronic product in domestic household waste.

Product Category: With reference to the equipment types in the WEEE directive Annex 1, this product is classified as a "Monitoring and Control instrumentation" product.

Do not dispose in domestic household waste.

To return unwanted products, contact your local Keysight office or visit the following website for more information.

- LCD Fluorescent Lamp

Certain products sold by Keysight contain a liquid crystal display (LCD); backlighting for the LCD is provided by a fluorescent lamp which contains mercury, and must be managed, recycled, and/or disposed in accordance with all applicable laws, ordinances and regulations.

- Perchlorate Information

Perchlorate Material - special handling may apply. Visit the following website.

Equipment's real-time clock battery or coin cell battery may contain perchlorate and may require special handling when recycled or disposed of in California.

---

## Precautionary Statement

Keysight B1505A Power Device Analyzer/Curve Tracer operates in the Microsoft Windows environment. Keysight B1505A requires Keysight EasyEXPERT software, a specially-designed Windows application program.

- About guarantee and support for Keysight B1505A

Keysight Technologies guarantees and supports the performance of Keysight B1505A for the same condition as the preload condition when shipped from the factory.

- About updating Keysight EasyEXPERT and the Windows Update

Keysight Technologies confirms the operation of Keysight EasyEXPERT patch programs and important Windows security patches, and provides recommended update information. Visit Keysight B1505A support site, download the patches, and perform the software update.

- About Windows application programs and peripherals (including driver)

Using commercial products on Keysight B1505A is your responsibility. Keysight Technologies cannot provide compatibility information for commercial products.

- About servicing

Bench repair service is available at your nearest Keysight Technologies service center. Be aware that the B1505A configuration might be updated to the latest one without notice because of support issues.

The internal hard disk drive (HDD) might be initialized during servicing. If peripherals are connected, they will be removed.

When Keysight B1505A is returned, the internal HDD might be initialized. Peripherals will be returned separately.

- Other notes

- Back up the internal HDD to prevent loss of data by accident or failure.
- Protect Keysight B1505A from computer viruses.
- If you connect Keysight B1505A to the network, take care to protect it from computer virus.

---

## Working in Comfort

To optimize your comfort and productivity, it is important that you set up your work area correctly and use your instrument properly. With that in mind, we have developed some set-up and use recommendations for you to follow based on established ergonomic principles. Improper and prolonged use of keyboards and input devices are among those tasks that have been associated with repetitive strain injury (RSI) to soft tissues in the hands and arms. If you experience discomfort or pain while using the instrument, discontinue use immediately and consult your physician as soon as possible. For more information on RSI you may wish to consult the *About Repetitive Strain Injury* section. Please study the recommendations described below. Included there are references to relevant parts of international standards, regulations and guidelines, such as ISO 9241 and the European Community Display Screen Equipment directive. You may also wish to consult your employer's human resources department or other relevant departments for guidance specific to your company.

### **About Repetitive Strain Injury**

Because your comfort and safety are our primary concern, we strongly recommend that you use the instrument in accordance with established ergonomic principles and recommendations. Scientific literature suggests that there may be a relationship between injury to soft tissues -especially in the hands and arms- and prolonged improper use of keyboards or other equipment requiring repeated motions of the hands and forearms. This literature also suggests that there are many other risk factors that may increase the chance of such injury, commonly called Repetitive Strain Injury.

#### *What is RSI?*

Repetitive Strain Injury (RSI -also known as cumulative trauma disorder or repetitive motion injury) is a type of injury where soft tissues in the body, such as muscles, nerves, or tendons, become irritated or inflamed. RSI has been a reported problem for those who perform repetitive tasks such as assembly line work, meatpacking, sewing, playing musical instruments, and computer work. RSI also has been observed in those who frequently engage in activities such as carpentry, knitting, housework, gardening, tennis, windsurfing and lifting children.

#### *What causes RSI?*

The specific causes of RSI have not been established. Nevertheless, the incidence of RSI has been associated with a variety of risk factors, including:

- Too many uninterrupted repetitions of an activity or motion.
- Performing an activity in an awkward or unnatural posture.

- Maintaining static posture for prolonged periods.
- Failing to take frequent short breaks.
- Other environmental and psychosocial factors.

In addition, there have been reports associating the occurrence of RSI with the use of keyboards, mice, and other input devices. Also, certain medical conditions, such as rheumatoid arthritis, obesity and diabetes, may predispose some people to this type of injury.

#### *What if I experience discomfort?*

If you are experiencing any discomfort, seek professional medical advice immediately. Typically, the earlier a problem is diagnosed and treated, the easier it is to resolve.

#### **Mice and Other Input Devices**

Various aspects of using mice and other input devices may increase your risk of discomfort or injury. Observing the following recommendations may reduce that risk.

- Try to keep your hand, wrist, and forearm in a neutral position while using your mouse or other input device.
- If you use your thumb to rotate the ball on a trackball or spaceball, keep it in a relaxed, natural shape, and maintain a neutral posture in your hand, wrist, and forearm.
- Hold the mouse gently by draping your fingers over it. Keep your hand relaxed and fingers loose. Do not grip the mouse tightly.
- It takes very little pressure or force from your fingers to activate the buttons or scroll wheel on your mouse, scrolling mouse, trackball, or other input device. Using too much force can place unnecessary stress on the tendons and muscles in your hands, wrists, and forearms.
- If you are using a scrolling mouse, be sure to keep your fingers and hand in a relaxed, neutral position when activating the scroll wheel. Also, this type of mouse features software that can minimize the number of mouse movements or button clicks.
- When using a mouse, trackball, or other input device, position it as close to the keyboard as possible, and keep it at the same level as you do not have to stretch while using it.
- Be sure to keep your mouse and trackball clean. Regular removal of accumulated dust and dirt helps ensure proper tracking and reduces unnecessary hand and wrist motions.

For more information, see “Working in Comfort” located at

[http://about.keysight.com/en/quality/Keysight\\_Ergonomic\\_Information.pdf](http://about.keysight.com/en/quality/Keysight_Ergonomic_Information.pdf).

---

## In This Manual

This manual describes the product overview and installation information of Keysight Technologies B1505A. This manual consists of the following chapters:

1. "Getting Started"

This chapter describes basic operations of Keysight B1505A.

2. "Introduction"

This chapter describes basic features of Keysight B1505A.

3. "Accessories"

This chapter describes accessories available for Keysight B1505A.

4. "Installation"

This chapter describes installation and maintenance.

5. "Measurement Examples"

This chapter introduces some measurement examples using Keysight B1505A.

---

**NOTE**

For the specifications of the B1505A, see Data Sheet.

---

**NOTE**

The information is subject to change without notice due to the future enhancement.

The actual screen image on the B1505A may be different from the image shown in this manual.

---





---

# Contents

## 1. Getting Started

To Turn On/Off B1505A .....	1-3
To Turn B1505A On .....	1-4
To Turn B1505A Off .....	1-4
To Launch EasyEXPERT .....	1-6
If Only One Workspace Exists .....	1-7
To Create Workspace .....	1-8
To Select Workspace .....	1-9
To Use Tracer Test Mode .....	1-10
To Use Application Test Mode .....	1-12
To Use Classic Test Mode .....	1-14
To Perform Measurement .....	1-16
To Use Test Result Editor .....	1-17
To Use Analysis Tools .....	1-18

## 2. Introduction













Overview .....	2-3
Keysight EasyEXPERT Software .....	2-7
Front View .....	2-9
 Rear View .....	2-12
Accessories and Options .....	2-19
Measurement Resources .....	2-27
GNDU - Ground Unit .....	2-27
About SMU .....	2-28
HPSMU - High Power SMU .....	2-29
HCSPMU - High Current SMU .....	2-32
HVSMU - High Voltage SMU .....	2-34

---



# Contents

MPSMU - Medium Power SMU . . . . .	2-36
MCSMU - Medium Current SMU . . . . .	2-39
HVMCU - High Voltage Medium Current Unit . . . . .	2-41
UHCU - Ultra High Current Unit . . . . .	2-43
UHVU - Ultra High Voltage Unit . . . . .	2-45
MFCMU - Multi Frequency CMU . . . . .	2-47

### 3. Accessories







 . . . . .	3-3
 N1258A Module Selector . . . . .	3-4
 N1259A Test Fixture . . . . .	3-9
N1260A High Voltage Bias-Tee . . . . .	3-26
N1261A Protection Adapter . . . . .	3-27
N1262A Resistor Box . . . . .	3-28
16493S-010/011 HCSMU Adapter . . . . .	3-30
16493S-020/021 Dual HCSMU Adapter . . . . .	3-31
 N1265A Ultra High Current Expander/Fixture . . . . .	3-33
 N1266A HVSMU Current Expander . . . . .	3-55
 N1267A HVSMU/HCSMU Fast Switch . . . . .	3-58
 N1268A Ultra High Voltage Expander . . . . .	3-67
N1269A Ultra High Voltage Connection Adapter . . . . .	3-70
 N1271A Thermal Test Enclosure . . . . .	3-71
 N1272A Device Capacitance Selector . . . . .	3-83
 N1273A Capacitance Test Fixture . . . . .	3-87
 N1274A On-Wafer Gate Charge Measurement Adapter/Selector for 20 A/3 kV . . . . .	3-99
 N1275A On-Wafer Gate Charge Measurement Adapter for N1265A . . . . .	3-103

### 4. Installation

 . . . . .	4-2
 Requirements . . . . .	4-5









---

# Contents

Power Requirements . . . . .	4-5
Operating Environment . . . . .	4-5
Storing/Shipping Environment . . . . .	4-5
 Installation Requirements . . . . .	4-6
 Power Cable . . . . .	4-7
Inspection and Installation . . . . .	4-9
To Inspect B1505A and Accessories . . . . .	4-9
To Perform Initial Setup . . . . .	4-10
To Change Windows Logon Setting . . . . .	4-11
To Change GPIB Address . . . . .	4-12
To Enable System Controller . . . . .	4-13
 Maintenance . . . . .	4-14
Cleaning . . . . .	4-14
 Self-test and Diagnosis . . . . .	4-14
Calibration . . . . .	4-15
 About Plug-in Modules . . . . .	4-16
<b>5. Measurement Examples</b>	
 Gate Charge Measurement . . . . .	5-3
 Preparing Measurement . . . . .	5-3
System Configuration and Open/Short Calibration . . . . .	5-5
Preparing Measurement Setups and Performing Measurements . . . . .	5-5
Packaged Device Testing Using Current Load Transistor on the N1259A-014 or N1265A-014 . . . . .	5-6
Packaged Device Testing Using Resistive Load on the N1259A-014 or N1265A-014 . . . . .	5-9
On-Wafer Auto-Testing Using Current Load Transistor on the N1274A	5-10
On-Wafer Auto-Testing Using Resistive Load on the N1274A . . . . .	5-11
On-Wafer Auto-Testing Using Current Load Transistor on the N1275A	5-13
On-Wafer Auto-Testing Using Resistive Load on the N1275A . . . . .	5-17

---

# Contents

Available Application Test List .....	5-21
 I-V and Capacitance Measurements Using N1272A .....	5-24
 Preparing Measurement .....	5-24
System Configuration and Open/Short Calibration .....	5-26
Preparing Capacitance Measurement Setups .....	5-27
Performing Capacitance Measurement .....	5-28
Preparing IV Measurement Setups .....	5-29
Performing IV Measurement .....	5-30
Available Application Test List .....	5-31
 Temperature Controlled by Thermal Plate .....	5-33
 Preparing Measurement .....	5-33
Preparing Temperature Control and Measurement Setups .....	5-35
 Performing Temperature Control and Measurement .....	5-37
Available Application Test List .....	5-38
 Temperature Controlled by ThermoStream .....	5-39
 Preparing Measurement .....	5-39
Preparing Temperature Control and Measurement Setups .....	5-41
 Performing Temperature Control and Measurement .....	5-43
Available Application Test List .....	5-44
Using Multiple HVSMU Modules .....	5-45
HVSMU Output Range .....	5-45
Setting Output Range Mode .....	5-46
Performing Measurement .....	5-46
Available Application Test List .....	5-46

---

**1**

# **Getting Started**

## Getting Started

This chapter describes the basic operations of Keysight B1505A. Before learning the product details, let's try to use the B1505A briefly. The operations need the B1505A, power cable, and USB keyboard only (USB mouse and stylus pen are optional). Keysight B1505A also requires Keysight EasyEXPERT software as its graphical user interface.

During the operations, you will not connect device under test. Open all measurement terminal.

This chapter consists of the following sections.

- “To Turn On/Off B1505A”
- “To Launch EasyEXPERT”
- “To Use Tracer Test Mode”
- “To Use Application Test Mode”
- “To Use Classic Test Mode”
- “To Perform Measurement”
- “To Use Analysis Tools”

---

### NOTE

#### **If you use the B1505A at the first time**

If this is the first time to turn Keysight B1505A on after the delivery, you need to perform the initial setup of the B1505A. See “[Inspection and Installation](#)” on page 4-9. After the initial setup and if no users are added, you can automatically logon as “Keysight B1500 User” account without password.

---

---

## To Turn On/Off B1505A

---

### NOTE

#### When turning the B1505A on

Open the measurement terminals at the device side when turning the B1505A on. Also disconnect the device from the measurement terminals and open the measurement terminals after the test. If you leave the connection with the device, the device may be damaged by unexpected operations or charge-up of measurement cables.

---

### NOTE

#### If Start EasyEXPERT button is not displayed

Select All Programs > Start EasyEXPERT from the Start menu. The Start EasyEXPERT button will be displayed.

---

### NOTE

#### Automatic start function

If the automatic start function is on, EasyEXPERT is launched within the B1505A boot up process. If the function is off, EasyEXPERT is not launched and the Start EasyEXPERT button is displayed.

To turn the automatic start function off, use the Start EasyEXPERT window displayed by the File > Exit menu on the EasyEXPERT main screen. And remove the check from the Option > Auto Start of EasyEXPERT menu.

---

### NOTE

#### If EasyEXPERT does not run

Launch “Keysight Connection Expert” by using the icon on Windows taskbar. And check the USB0 connection status displayed in “Instrument I/O on this PC” area.

USB0 connection status display example:

```
USB0
+ B1500A (USB0::2391::1::0001::0::INSTR)
  + agb1500a
  + UsbDevice1
```

If “agb1500a” and “UsbDevice1” are not listed, add them by using a dialog box which is opened by right-clicking on B1500A (USB0:: . . ::INSTR) and selecting “Add VISA Alias” from the menu. For more information, see *Connectivity Guide* opened from the Help menu on the Connection Expert window.

Getting Started  
To Turn On/Off B1505A

## To Turn B1505A On

1. Connect the power cable from Keysight B1505A to an AC power outlet.
2. Connect the USB keyboard to the B1505A. Optionally, connect the USB mouse to the B1505A.
3. Press the Standby switch (lower right corner of the front panel). Windows, measurement module initialization, and self-calibration will start. For the Windows logon screen, log on Windows.

After logging on, the Start EasyEXPERT button will be displayed on the screen, or EasyEXPERT will be launched if the automatic start function is on.

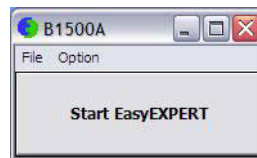

## To Turn B1505A Off

Press the Standby switch (lower right corner of the front panel). Windows will be shutdown and the B1505A will become the standby state.

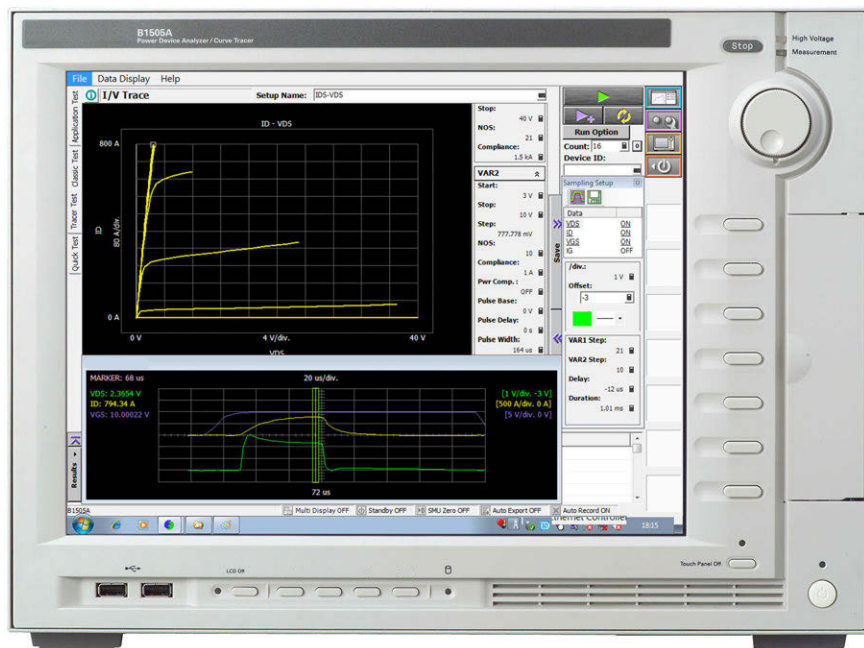



---

**NOTE**

Keysight B1505A has the following front panel user interface.

- **Stop**  
Stops the present measurement or source output immediately.
- **Rotary knob**  
Rotating the knob moves the marker on the graph window, or increases/decreases/changes the value in the active entry field.  
Pressing the knob sets or enters the value.
- **Softkeys**  
Seven softkeys are available. Used to select one for the entry field specified or the dialog box. They are also used to recall the test definitions (pre-defined test setups).
- **Touch Panel Off**  
Enables or disables the touch screen operation.
- **Standby switch**  
Turns the B1505A on. Pressing the button in the ON state makes the B1505A in the standby state.
- **LCD Off**  
Enables or disables the LCD panel. LED lights when the LCD is disabled.
- **+, -, Set, Cancel**  
Four keys are available for adjusting brightness. Use + and - to adjust it and then press *Set* to fix it. Pressing *Cancel* instead of *Set* cancels the adjustment.

Keysight B1505A also requires Keysight EasyEXPERT software as its graphical user interface. You can operate Keysight EasyEXPERT by using the touch panel. Use your fingers, stylus pen, and so on for the touch panel operation. The USB keyboard and the USB mouse are also available for operating the EasyEXPERT.

To remove USB devices from the B1505A, use “Safely Remove Hardware” on Windows taskbar. If it is not used, the B1505A may cause the internal USB communication error. If the error occurs, turn the B1505A off and disconnect the power cable from the B1505A. Leave it about 30 seconds before rebooting the B1505A, and connect the power cable again, and then turn the B1505A on.

---

## To Launch EasyEXPERT

1. If the automatic start function is off, the Start EasyEXPERT button is displayed. Click the button and wait until the EasyEXPERT main screen or workspace selection screen is displayed.

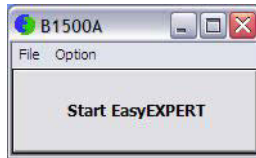

---

### NOTE

Workspace is the space created in Keysight B1505A's internal hard disk drive, and is used to store the test setup, test result data, and so on. The workspace can be created and allocated for each user.

2. If this is the first time to start the EasyEXPERT, or if no workspace exists, a workspace will be created automatically.  
Skip to [“To Use Tracer Test Mode” on page 1-10](#), [“To Use Application Test Mode” on page 1-12](#), or [“To Use Classic Test Mode” on page 1-14](#).
3. If only one workspace exists, the B1505A displays the screen as shown in [Figure 1-1](#).  
Skip to [“If Only One Workspace Exists” on page 1-7](#).
4. If two or more workspaces exist, the B1505A displays the screen as shown in [Figure 1-3](#).  
Skip to [“To Select Workspace” on page 1-9](#).

## If Only One Workspace Exists

For the screen as shown in [Figure 1-1](#), perform the following steps.

- If you do not want to create a workspace, select the *Yes* radio button and click OK. Skip to [“To Use Tracer Test Mode” on page 1-10](#), [“To Use Application Test Mode” on page 1-12](#), or [“To Use Classic Test Mode” on page 1-14](#).
- If you want to create a workspace, select the *No, I want to start a new session.* radio button and click Next. The B1500A displays the screen as shown in [Figure 1-2](#). Skip to [“To Create Workspace” on page 1-8](#).
- If you want to manage workspaces, select the *No, I want to manage Workspaces.* radio button and click Next. The B1500A displays the screen as shown in [Figure 1-3](#). Skip to [“To Select Workspace” on page 1-9](#).

Figure 1-1

### If Only One Workspace Exists

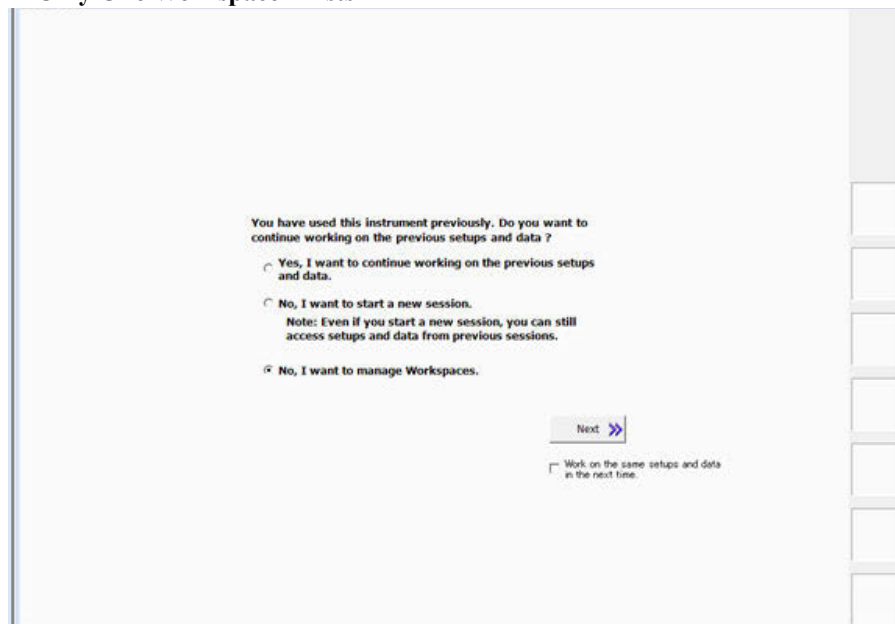

---

#### NOTE

#### Work on the same setups and data next time

If this check box is checked, the workspace selection screen will be skipped at the next startup and EasyEXPERT will be launched with the workspace used at the last operation. To perform this setup again, click the File > Close Workspace menu on the EasyEXPERT main screen.

## To Create Workspace

For the screen as shown in [Figure 1-2](#), perform the following steps. To cancel creating workspace, click Prev.

1. Enter the name of the new workspace into the above-entry field.  
*Check **Allow other users to access this workspace** box if you want to create a public workspace that is opened for all users.*
2. If you are the owner of the existing workspace, you can change the name of the existing workspace.  
*If you want to rename the existing workspace, enter the name into the below-entry field.*  
*Check **Allow other users to access this workspace** box if you want to set it to a public workspace that is opened for all users.*
3. Click OK.

Skip to [“To Use Tracer Test Mode” on page 1-10](#), [“To Use Application Test Mode” on page 1-12](#), or [“To Use Classic Test Mode” on page 1-14](#).

Figure 1-2

### To Create Workspace

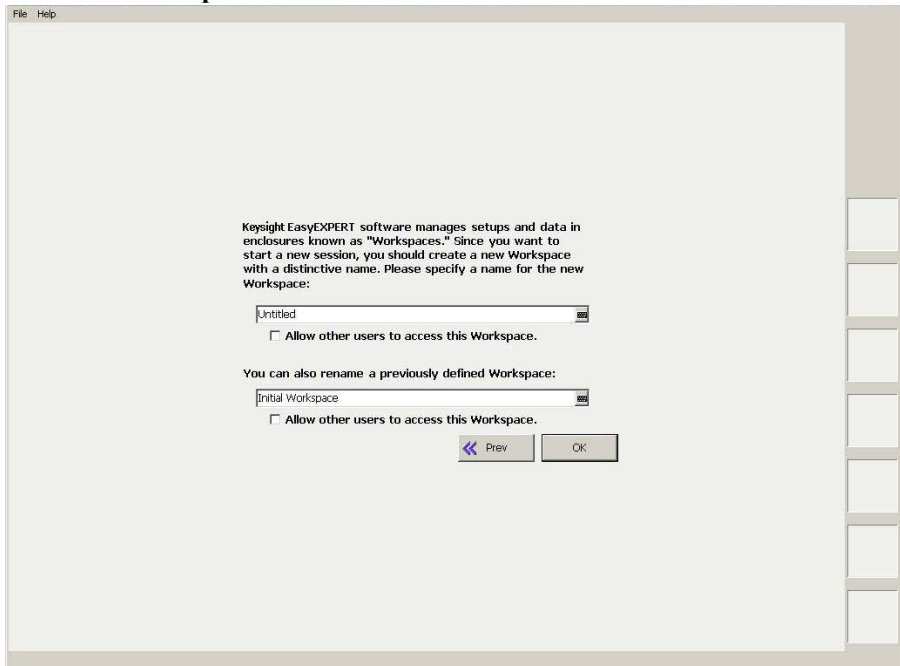

## To Select Workspace

For the screen as shown in [Figure 1-3](#), perform the following steps. This example selects the workspace named as *test* that is a private workspace.

1. Select *Your Workspaces* radio button.
2. Select *test* and click Continue.

Skip to [“To Use Tracer Test Mode” on page 1-10](#), [“To Use Application Test Mode” on page 1-12](#), or [“To Use Classic Test Mode” on page 1-14](#).

If you want to manage workspaces, click the *Manage Workspaces* button. See *Keysight EasyEXPERT User’s Guide*.

**Figure 1-3**

### To Select Workspace

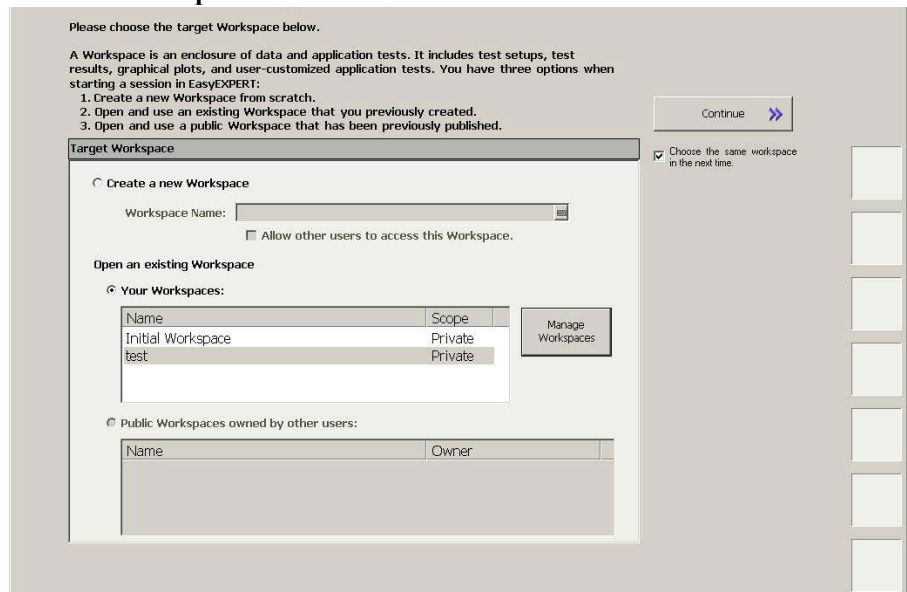

---

### NOTE

#### Choose the same Workspace in the next time



If this check box is checked, the workspace selection screen will be skipped at the next startup and EasyEXPERT will be launched with the workspace used at the last operation. To perform this setup again, click the File > Close Workspace menu on the EasyEXPERT main screen.

## To Use Tracer Test Mode

The following procedure performs the tracer test setup.

1. Click the Tracer Test tab on the main screen. The tab is in the leftmost column on the screen. The I/V Trace screen is displayed. See [Figure 1-4](#).
2. Set the channels at the field below the graph as shown in [Table 1-1](#).
3. Set the measurement condition at the right field of the graph as shown in [Table 1-3](#).
4. Set the graph display condition at the field below the graph as shown in [Table 1-2](#).

To enter the value, use the USB keyboard or the screen/numeric keyboard opened by clicking the right button of the entry field.

To start measurement, click  for the single measurement or  for the repeat measurement.

If the Stop field is highlighted, the range of measurement and graph display can be changed by using the rotary knob during the repeat measurement.

**Table 1-1**

**I/V Trace Channel Setup**

Unit	V Name	I Name	Mode <sup>a</sup>	Function
SMU1	V1	I1	V	VAR1
SMU2	V2	I2	V	CONST

- a. Channel output mode. Set I or IPULSE for the current output and voltage measurement. Set V or VPULSE for the voltage output and current measurement.

**Table 1-2**

**I/V Trace Graph Setup**

	Name	Scale			Name	Scale	
<b>Y</b> ↑	I1	LIN	±	→ <b>X</b>	V1	LIN	±

**Table 1-3 I/V Trace Measurement Setup**

VAR1		CONST	
<b>Mode</b>	LIN-SGL	<b>Unit</b>	SMU2
<b>Start</b>	0 V	<b>Source</b>	0 V
<b>Stop</b>	1 V	<b>Compliance</b>	5 mA
<b>Step</b>	10 mV		
<b>NOS</b>	101		
<b>Interlacing</b>	1		
<b>Compliance</b>	5 mA		
<b>Pwr Comp.</b>	OFF	<b>Meas. Time</b>	2 $\mu$ s
<b>Dual Polarity</b>	ON	<b>Step Time</b>	500 $\mu$ s

**Figure 1-4 Display Example of I/V Trace Screen**

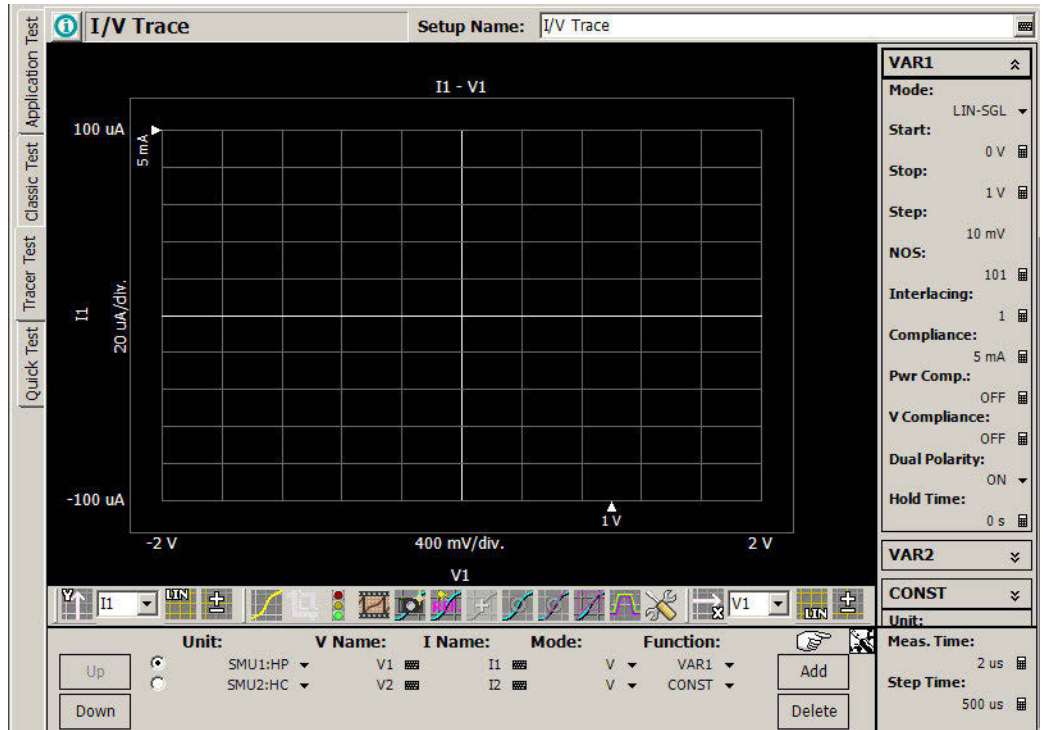

---

## To Use Application Test Mode

For the screen as shown in [Figure 1-5](#), perform the following procedure.

Figure 1-5

### Display Example of EasyEXPERT Main Screen

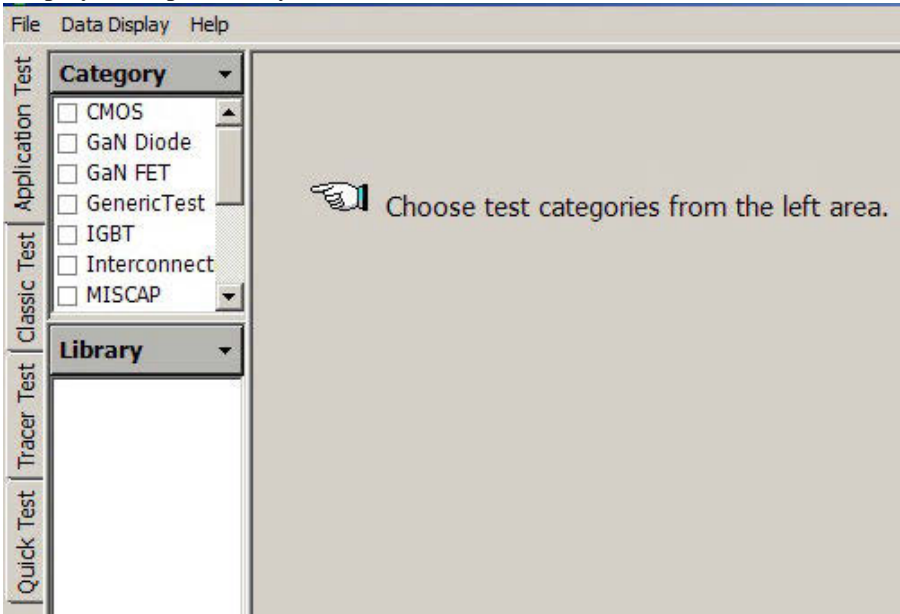

1. Click the Application Test tab on the main screen. The tab is in the leftmost column on the screen.
2. Set the Category field. For example, check the PowerMOSFET only. The Library field lists the test definitions.
3. Select a test definition at the Library field. For example, click the *Id-Vgs* and *Select* button sequentially. The screen changes the display as shown in [Figure 1-6](#).
4. Change the measurement conditions at the Test Parameters field.  
The following example changes the voltage sweep output.
  - a. Set VgStop to 5.0 V.
  - b. Set VdStart and VdStop to 5.0 V.



To enter the value, use the USB keyboard or the screen/numeric keyboard opened by clicking the right button of the entry field.

See [“To Perform Measurement” on page 1-16](#) to start measurement.

**NOTE**

**Test Definitions**

Test definitions are the built-in test setups that have been defined and stored in the EasyEXPERT as the application library. The EasyEXPERT contains more than forty test definitions. You can execute the test without modifications. Also you can create your own test setup/definition by making any changes. All furnished test definitions are just sample. Keysight Technologies is NOT LIABLE for any damages caused by the samples.

**Figure 1-6** Display Example of Application Test Setup Screen

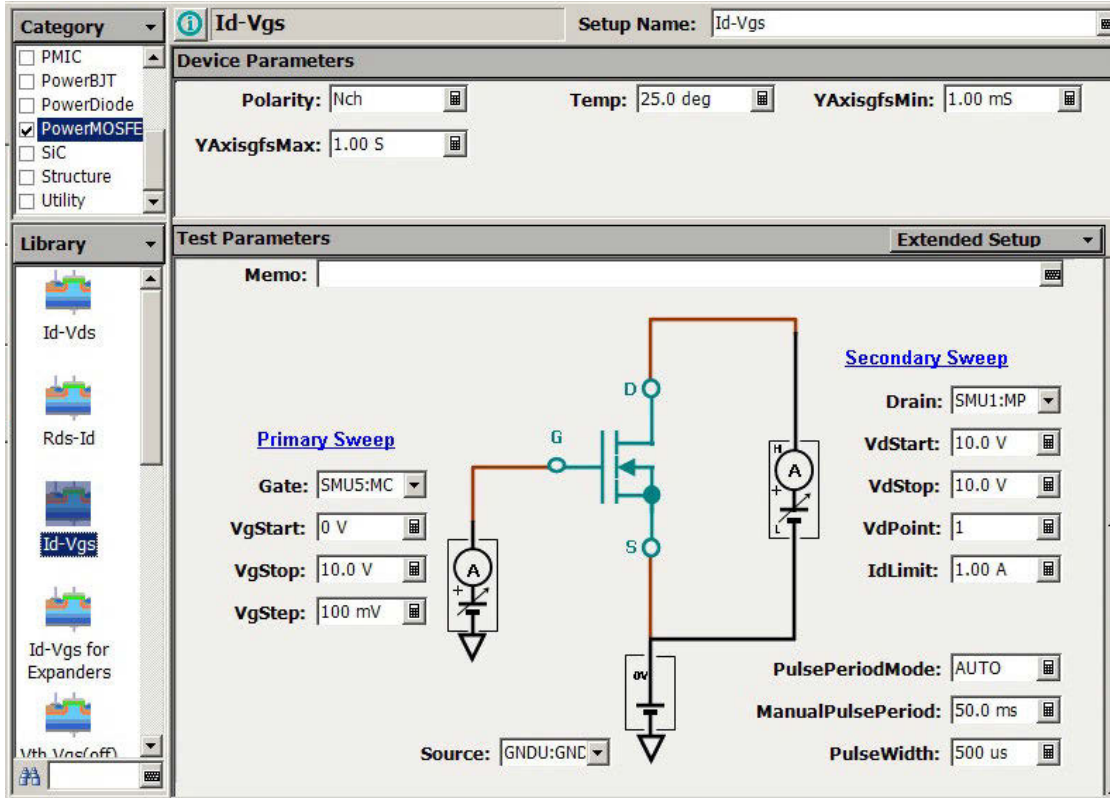

## To Use Classic Test Mode

The following procedure performs the I/V Sweep classic test setup.

1. Click the Classic Test tab on the main screen. The tab is in the leftmost column on the screen.
2. Click I/V Sweep and Select button sequentially. The I/V Sweep Channel Setup screen is displayed. See [Figure 1-7](#).
3. Set the Channel Setup parameters as shown in [Table 1-4](#).
4. Click the Measurement Setup tab and set the parameters as shown in [Table 1-5](#).
5. Click the Display Setup tab and set the parameters as shown in [Table 1-6](#).

To enter the value, use the USB keyboard or the screen/numeric keyboard opened by clicking the right button of the entry field.

Figure 1-7

### Display Example of I/V Sweep Channel Setup Screen

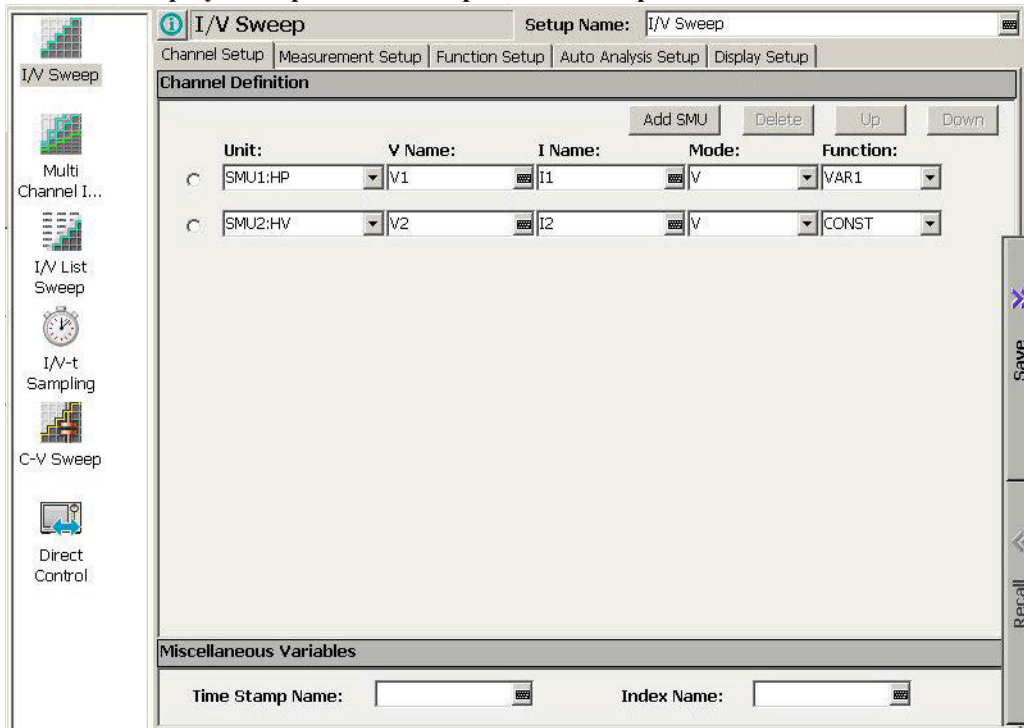

See “To Perform Measurement” on page 1-16 to start measurement.

**Table 1-4 I/V Sweep Channel Setup**

Unit	V Name	I Name	Mode <sup>a</sup>	Function
SMU1	V1	I1	V	VAR1
SMU2	V2	I2	V	CONST

a. Channel output mode. Set I or IPULSE for the current output and voltage measurement. Set V, VPULSE, or COMMON for the voltage output and current measurement.

**Table 1-5 I/V Sweep Measurement Setup**

VAR1		Timing		Constants	
Unit	SMU1	Hold	0 s	Unit	SMU2
Name	V1	Delay	0 s	V Name	V2
Direction	Single			I Name	I2
Linear/Log	LINEAR			Mode	V
Start	0 V			Source	0 V
Stop	1 V			Compliance	5 mA
Step	10 mV				
No of Step	101				
Compliance	5 mA				
Pwr Comp	OFF	Sweep	CONTINUE AT ANY	status	

**Table 1-6 I/V Sweep Display Setup**

	Name	Sharing	Scale	Min	Max
<b>X</b>	V1	(None)	Linear	0 V	1 V
<b>Y1</b>	I1	(None)	Linear	-5 mA	5 mA

## To Perform Measurement

1. Click the Single button (upper right on the main screen) to start measurement. This opens the Data Display window and starts a single sweep measurement.



After the measurement, the measurement data is displayed on the Data Display window. For the measurement after performing “[To Use Classic Test Mode](#)” on [page 1-14](#), you will have the test result as shown in [Figure 1-8](#). This is the leakage current measurement result because all measurement terminal is opened for performing the procedures described in this chapter.

2. If the automatic data record function has been set to ON (Auto Record ON), Test Result Editor appears on the lower area of the screen when the measurement is completed. See “[To Use Test Result Editor](#)” on [page 1-17](#).

**Figure 1-8** Display Example of Data Display Window

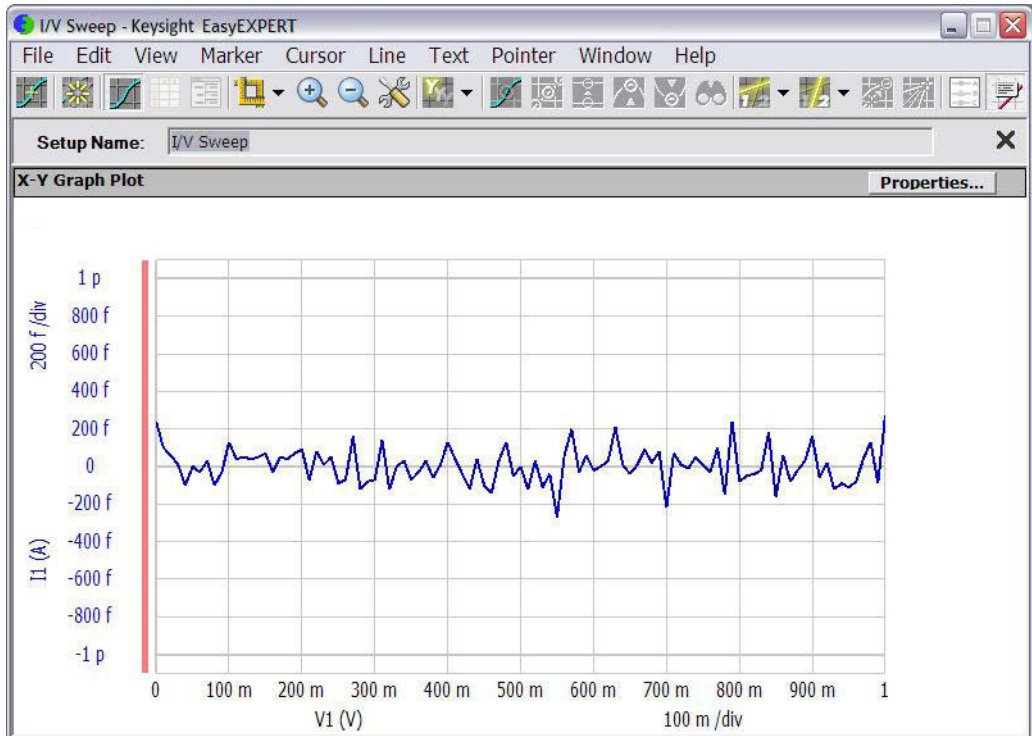

## To Use Test Result Editor

The Test Result Editor provides the following GUI to set a flag and remarks to the test result record.

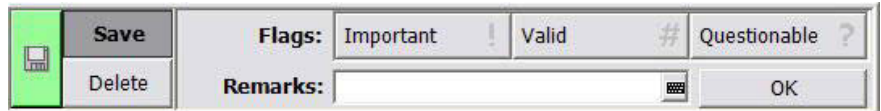

- Save button and Delete button  
Divides test records into groups, Save and Delete.  
Test records in Save-group are always listed in the lower area of the EasyEXPERT main screen.  
Test records in Delete-group can be listed when Results > Filter > Show Deleted Data is checked.
- Flags buttons  
The following buttons are available. You can set one of the following flags.
  - Important ! button  
Sets the important flag (!) to the test result record.
  - Valid # button  
Sets the valid flag (#) to the test result record.
  - Questionable ? button  
Sets the questionable flag (?) to the test result record.
- Remarks field  
You can enter characters into this field. The characters will be recorded as the Remarks value of the test result record.
- OK button  
Applies the setup on the Test Result Editor, and closes this dialog box.

## To Use Analysis Tools

The Data Display window provides several analysis functions.

- View menu: used to adjust the graph scale.
- Marker menu: used to display and control the marker.
- Cursor menu: used to display and control the cursor.
- Line menu: used to display and control the lines.

When the marker, cursor, and lines are effective, their parameters are also displayed on the X-Y Graph Plot area.

Figure 1-9 is an example displaying marker, tangent line, and regression line on the test result graph shown in Figure 1-8. You can read position of the marker and the active cursor, and interrupt and gradient of the active line.

Figure 1-9 Display Example of Analysis Tools

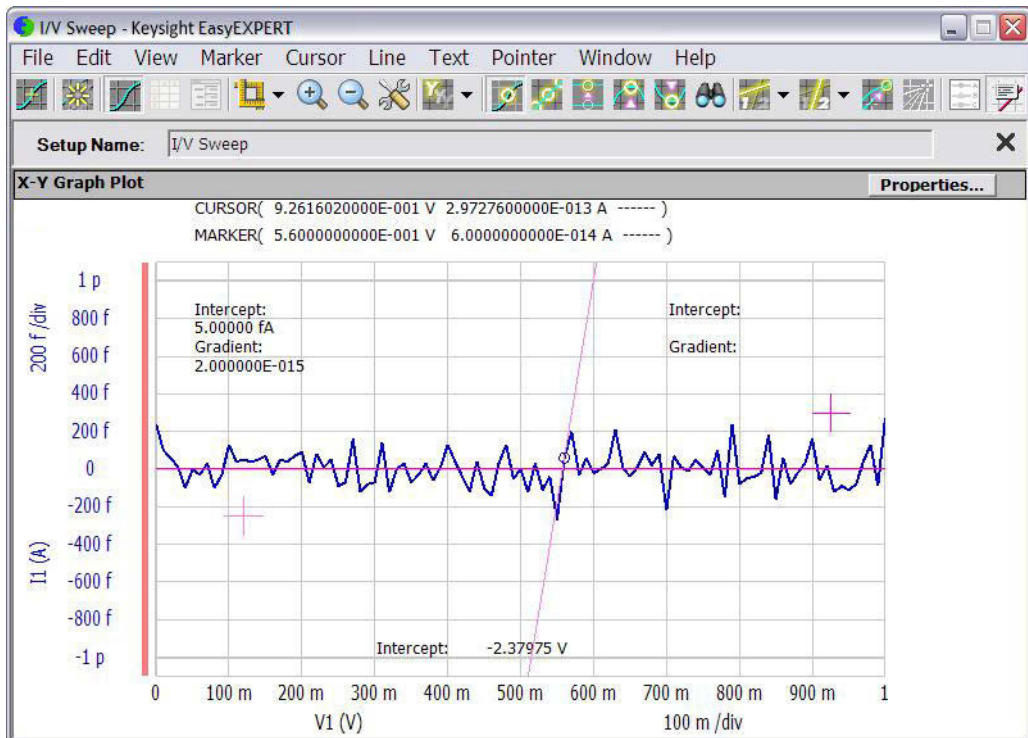

---

**2**

## **Introduction**

This chapter describes the basic functions and features of Keysight B1505A Power Device Analyzer/Curve Tracer, and consists of the following sections:

- “Overview”
- “Front View”
- “Rear View”
- “Accessories and Options”
- “Measurement Resources”

---

**NOTE****Application Library**

Keysight B1505A has installed Keysight EasyEXPERT software as the user interface. The EasyEXPERT contains an application library that is a set of test definitions. The application test can be performed by selecting a test definition and setting the test condition for the actual DUT (device under test).

All test definitions are just sample. If the samples damage your devices, Keysight Technologies is NOT LIABLE for the damage.

---

**NOTE****Furnished Sample Programs (Utility)**

The following sample programs are stored in the following folder.

- <program folder>\Agilent\B1500\EasyEXPERT\Utilities\  
Prober control programs  
sleep.exe program
- <program folder>\Agilent\B1500\EasyEXPERT\415xC\Conversion\  
4155/4156 setup file converter
- <program folder>\Agilent\B1500\EasyEXPERT\IC-CAP Support\MDM\  
MDM file converter for IC-CAP users

Where, <program folder> is as follows. Then, <system drive> is the drive the EasyEXPERT has been installed.

For Windows 7 64 bit version, <system drive>:\Program Files (x86)

For Windows 7 32 bit version, Vista, or XP, <system drive>:\Program Files

For more details of programs, see Keysight EasyEXPERT User’s Guide.

---



---

## Overview

Keysight B1505A Power Device Analyzer/Curve Tracer is the parameter analyzer supporting ultra high voltage and ultra high current and is the one box solution for the power device DC parametric measurement and analysis application. Keysight B1505A provides the DC voltage/current output capability, DC voltage/current measurement capability, and impedance measurement capability. So you can perform a current-voltage sweep measurement and a capacitance-voltage sweep measurement for example by one instrument.

Keysight B1505A also provides an intuitive graphical user interface, touch screen LCD panel, keyboard, and mouse for easy and effective measurement and analysis on the Windows environment. You can analyze a measurement result characteristics graph for example by using several tools such as markers, cursors, and lines.

Also, in the GPIB remote control mode, you can control the B1505A from an external computer by using Keysight FLEX command set that is the common language for Keysight semiconductor DC measurement instruments. So you can reuse the measurement program created for Keysight 4155/4156/B1500/E5260/E5270.



- Keysight B1505A Power Device Analyzer/Curve Tracer

Mainframe that provides the ground unit (GNDU) and ten empty slots for the measurement facilities, and Keysight EasyEXPERT software for the operating environment. The EasyEXPERT is the GUI based measurement control and analysis software runs on the Windows.

This instrument is equipped with the 15 inch LCD with touch panel, hard disk drive, DVD drive, and USB/LAN/GP-IB interfaces. This instrument is also furnished with the USB keyboard, the USB mouse, and the stylus pen.

- HPSMU module

High power source/monitor unit module. Occupies two slots.

- HCSMU module

High current source/monitor unit module. Occupies two slots.

- HVSMU module

High voltage source/monitor unit module. Occupies two slots.

Multiple B1513A/B1513B HVSMU modules cannot be installed in one mainframe. The B1513A HVSMU cannot be used with the N1267A HVSMU/HCSMU Fast Switch.

- MPSMU module

Medium power source/monitor unit module. Occupies one slot.

- MCSMU module

Medium current source/monitor unit module. Occupies one slot.

- MFCMU module

Multi frequency capacitance measurement unit module. Occupies one slot.

- Keysight N1258A Module selector

Selector box to switch the measurement resource connected to the device under test (DUT). The measurement resource will be HPSMU/MPSMU, HCSMU/DHCSMU (dual HCSMU), or HVSMU/HVMCU (high voltage medium current unit, configured by N1266A).

- Keysight N1259A Test fixture  
Test fixture for measurements of packaged devices. Can install the module selector for switching the measurement resource connected to the DUT, the high voltage resistor box for reducing the risk of device breakdown, and the high voltage bias-tee for performing the high voltage capacitance measurement. Protection adapters are initially installed.  
Cannot be used with the N1265A or N1268A expander.
- Keysight N1260A High voltage bias-tee  
Bias-tee for performing the high voltage capacitance measurement of up to 3000 Vdc.
- Keysight N1261A Protection adapter  
Adapter box for protecting GNDU, HPSMU, or MPSMU from high voltage.
- Keysight N1262A High voltage resistor box  
Resistor box for reducing the risk of device breakdown or preventing SMU from oscillation. 1 k $\Omega$  ( $\pm$  200 Vdc), 100 k $\Omega$  ( $\pm$  3000 Vdc), or 1 M $\Omega$  ( $\pm$  3000 Vdc). Blank box is also available for installing your desired resistor.
- Keysight N1265A Ultra high current expander/fixture  
Current expander to enable 500 A or 1500 A (option N1265A-015) output and measurement. Configures ultra high current unit (UHCU) with two HC/MCSMU modules.  
Can be the test fixture for measurements of packaged devices. The N1265A-035 universal resistor box is required for making your desired resistor box. The N1265A-040 protection adapter is required for protecting SMU from ultra high voltage by the N1268A. The N1265A-041 thermocouple is required for performing temperature measurement. The N1260A bias-tee is required for performing the high voltage capacitance measurement of up to 3000 Vdc. The N1265A-014 gate charge socket module is required for performing the gate charge measurement.  
Selector is initially installed for switching the measurement resource connected to the DUT. The measurement resource will be the UHCU, HP/MPSMU, or HVSMU/HVMCU.  
The N1254A-524 ultra high current prober system cable is required for extending the selector output to your prober station.

- **Keysight N1266A HVSMU current expander**  
Current expander for HVSMU. Maximum current is expanded up to 2.5 A. Configures high voltage medium current unit (HVMCU) with the HVSMU module and two HC/MCSMU modules.  
Selector is initially installed for switching the HVSMU or the HVMCU connected to the DUT.
- **Keysight N1267A HVSMU/HCSMU fast switch**  
Selector box to switch the measurement resource connected to the DUT. The measurement resource will be HCSMU or HVSMU. One MCSMU module is required to control switching.
- **Keysight N1268A Ultra high voltage expander**  
Voltage expander to enable 10 kV output and measurement. Configures ultra high voltage unit (UHVU) with two HC/MCSMU modules.
- **Keysight N1269A Ultra high voltage connection adapter**  
Adapter box to connect the N1268A expander Low terminal and the MCSMU modules to the DUT gate and source terminals and the prober chuck. Protection adapters for MCSMU are initially installed.
- **Keysight N1271A Thermal Test Enclosure**  
Enclosure to enable thermal testing on N1259A/N1265A fixtures with inTEST Thermal Plate or Thermostream.
- **Keysight N1272A Device Capacitance Selector**  
Selector box to switch the measurement resource connected to the device under test (DUT), for packaged device capacitance testing (input/output capacitance, feedback capacitance, and gate resistance). The measurement resource will be HVSMU, MPSMU and MFCMU. This is used with the N1273A capacitance test fixture or a prober station.
- **Keysight N1273A Capacitance Test Fixture**  
Test fixture to enable packaged device capacitance testing (input/output capacitance, feedback capacitance, and gate resistance) in conjunction with the N1272A Device Capacitance Selector.

- Keysight N1274A On-Wafer Gate Charge Measurement Adapter/Selector for 20 A/3 kV  
Adapter to enable on-wafer gate charge measurements using the HCSMU (max. 20 A) and HVSMU (max. 3 kV). This equips an internal selector to automatically switch signal paths of I-V measurement and gate charge measurement. The N1274A is used with the N1258A module selector.
- Keysight N1275A On-Wafer Gate Charge Measurement Adapter for N1265A  
Adapter to enable on-wafer gate charge measurements with the UHCU (max. 500 A) and HVSMU (max. 3 kV). You need to switch signal paths of I-V measurement and gate charge measurement manually. And also, you need manual switching between high voltage and high current gate charge measurements.

## Keysight EasyEXPERT Software

Keysight EasyEXPERT software is a specially-designed Windows application program for controlling Keysight B1500 series. The EasyEXPERT provides the easy and effective measurement and analysis environment with intuitive graphical user interface (GUI), touch screen LCD panel, keyboard, and mouse. Some of the functions are listed below.

- Single measurement, repeat measurement, and append measurement
- Module selector control
- Measurement/setup data management by workspace
- Graph display and analysis with markers, cursors, and lines; and auto analysis
- Data import/export capability, data output by CSV/XML format, and graph output by EMF/BMP/GIF/PNG format
- Maintenance; self-test and self-calibration
- Remote control function from an external computer

The EasyEXPERT has the following measurement execution environments.

- Application test
- Classic test
- Tracer test
- Quick test

**Application Test** The EasyEXPERT contains an application library that supports typical measurements for IGBT, PMIC, power MOSFET, power BJT, power diode, and so on. The application library includes more than forty test definitions.

You can perform measurements by choosing the best one for your device under test (DUT) from the application libraries, and modifying and executing it. Modification is really simple. For example, it will be completed by changing the output voltage only to DUT terminals. And the setup with your modifications can be saved and recalled as your setup (*My Favorite*).

**Classic Test** You can perform measurements by using the user interface similar to the semiconductor parameter analyzers such as Keysight 4156C. The setup can be made by entering values into the setup tables used for the measurement resource control. And it can be saved and recalled as your setup (*My Favorite*). This measurement environment provides the following functions.

- I/V Sweep
- Multi Channel I/V Sweep
- I/V List Sweep
- I/V-t Sampling
- C-V Sweep
- Direct Control

The Direct Control test mode is used to control the measurement resources directly by using the B1505A GPIB control commands and perform measurement. For the control commands, see Keysight B1500 *Programming Guide*.

**Tracer Test** Curve tracer test mode. This test allows you to perform the high speed I-V measurement on one screen. The Tracer Test screen provides GUI for selecting the used channels, setting the sweep output, and displaying the measurement result (tracing the I-V curve). Range of the sweep output and measurement can be changed by the rotary knob on the front panel.

Tracer test also provides the oscilloscope view to display the pulse current or voltage output waveform of the HCSMU, DHCSMU, MCSMU, HVSMU, HVMCU, UHCU, or UHVU. You can verify output waveform over the I-V curve.

**Quick Test** You can execute the test setups saved in a preset group (*My Favorite*) sequentially.

## Front View

This section describes the front view of Keysight B1505A.

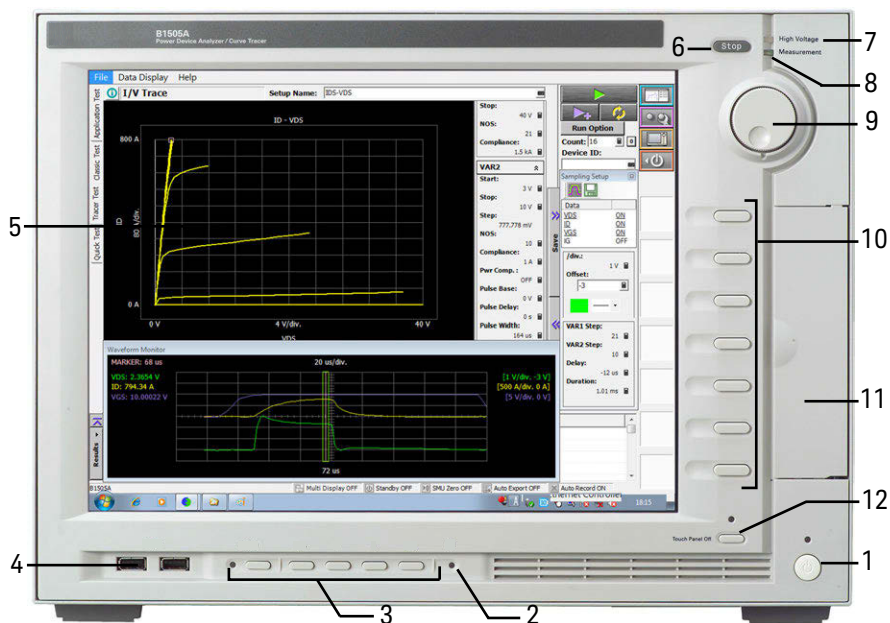

### 1. Standby switch

Turns the instrument on. Pressing the button in the ON state makes it in the standby state. The green LED lights when it is in the ON state.

## NOTE

### Before turning the B1505A on

Open the measurement terminals at the device side when turning the B1505A on. Also disconnect the device from the measurement terminals and open the measurement terminals after the measurement. If you leave the connection with the device, the device may be damaged by unexpected operations or charge-up of measurement cables.

### 2. HDD access indicator

This green LED lights in the access status of HDD or DVD drive. Do not turn the instrument off during this LED lights.

3. LCD adjustment keys

LCD Off enables or disables the LCD panel. The green LED lights when the LCD is disabled.

Four keys are available for adjusting brightness. Use + and – to adjust it and then press *Set* to fix it. Pressing *Cancel* instead of *Set* cancels the adjustment.

4. USB interfaces

USB, 2 ports. For keyboard, mouse, and so on.

To remove USB devices from the instrument, use “Safely Remove Hardware” on Windows taskbar. If it is not used, the instrument may cause the internal USB communication error. If the error occurs, turn the instrument off and disconnect the power cable from it. Leave it about 30 seconds before rebooting it, and connect the power cable again, and then turn the instrument on.

5. LCD panel

15 inch TFT XGA display, 1024 × 768 resolution. Displays the Windows screen, Keysight EasyEXPERT software window, and so on. Touch screen operation is available when the Touch Panel Off indicator does not light.

To adjust the touch panel, use Microchip TSHARC Control Panel which is opened by selecting *Microchip TSHARC Control Panel* from the Start menu.

6. Stop key

Stops the present measurement or source output immediately.

7. High voltage status indicator

This red LED lights when a source channel applies dangerous voltage.

8. Measurement status indicator

This green LED lights when a measurement channel performs measurement.

9. Rotary knob

Works on Keysight EasyEXPERT environment. Rotating the knob moves the marker on the graph window, or increases/decreases/changes the value in the active entry field. Pressing the knob sets or enters the value.

10. Softkeys

Seven softkeys are available for Keysight EasyEXPERT environment. Used to select an alternative for the entry field specified or the dialog box.



### 11. DVD-R drive

For data backup, software update, and so on. With the option DR1, the drive is changed to the DVD-ROM drive.

### 12. Touch Panel Off key

Works on the execution environment of EasyEXPERT software. Enables or disables the touch screen operation. The green LED lights when the touch screen is disabled.

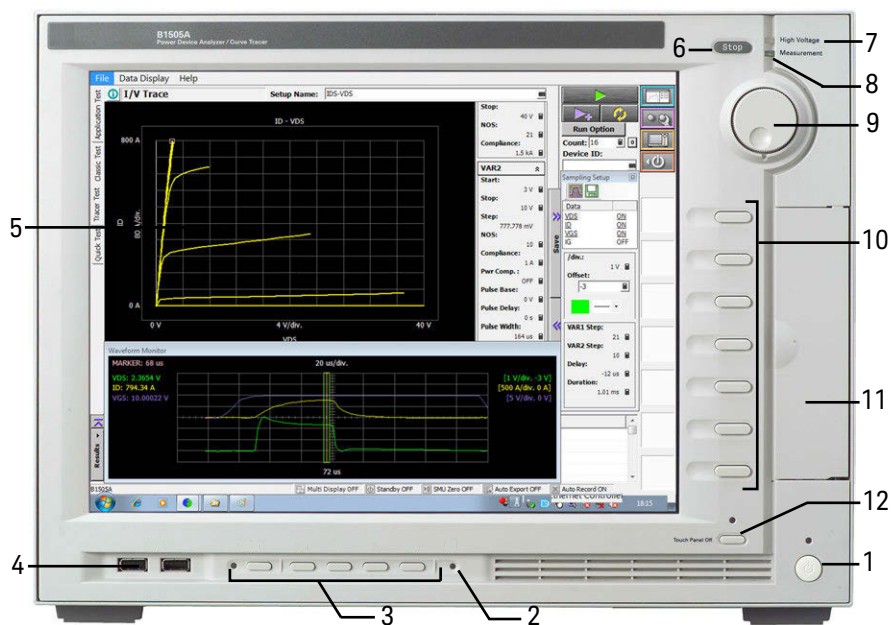

## Rear View

This section describes the rear view of Keysight B1505A.

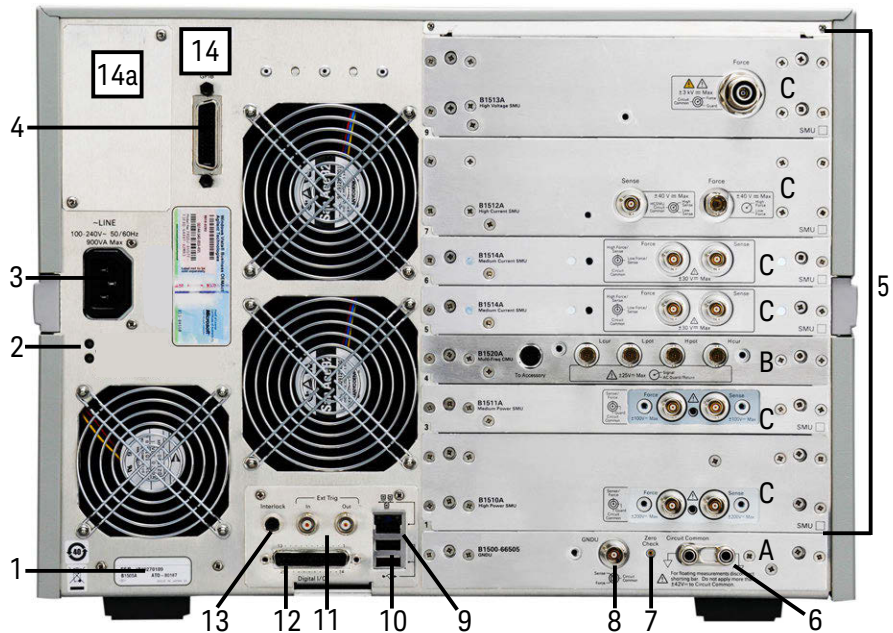

### 1. Serial number

You need this *serial number* when using Keysight Technologies telephone assistance program.

### 2. LED status indicator

For troubleshooting. Followings are some examples.

- Both LEDs turn off:  
The instrument is in the standby state and Standby switch is OFF position.
- One LED turns green:  
Power supply works normally.
- Both LEDs turn orange:  
The instrument is in the standby state and Standby switch is ON position.

3. LINE input receptacle

AC power cable is connected to this receptacle.



4. GPIB interface

For the GPIB connection of this instrument, use an GPIB interface, Keysight 82350B (for PCI bus), Keysight 82357A/B (USB/GPIB), or National Instrument GPIB-USB-HS.

For using an USB/GPIB interface, it is recommended to set the GPIB address of this instrument to an even number. The USB/GPIB interface might cause serial poll error intermittently due to the intrinsic communication scheme differences. It is reported that using an even GPIB address sometimes significantly decreases the chance of the error.

5. Module slot

Ten slots are available for installing the modules. Several kinds of module can be installed in the B1505A. However, the allowable number to install is different by the module type. See “[Measurement Resources](#)” on page 2-27. Also, there is a rule for the installation order by the module type. See [Chapter 4, “Installation.”](#)

 6. Circuit Common () and frame ground () terminals

Normally, connect the terminals together by using the shorting bar. For floating measurement, remove the shorting bar.

---

**WARNING**



If the Circuit Common terminal is *not* connected to the frame ground terminal (for floating measurement), a potential shock hazard may present. Do not touch any of measurement circuit at any time while a floating measurement is in progress.

Si la borne Circuit Common *n'est pas* connectée à la borne de terre du cadre (pour des mesures de flotte), il peut y avoir un risque de choc électrique. Ne touchez aucun circuit de mesure à n'importe quel moment quand la mesure de flotte est en cours.

---

**CAUTION**

For floating measurement, do not apply dangerous voltage to the Circuit Common terminal. Failure to heed this caution may result in damage to the instrument.

7. Zero Check terminal

Ground reference point of the instrument.

---

**CAUTION**

---

The Zero Check terminal can be used for the service purpose only. For the normal operation, leave this terminal open and do not connect anything to this terminal. Connecting anything can damage the instrument.

8. GNDU terminal

0 V constant voltage source. Used for the reference of measurement ground.  
Triaxial connector.

9. LAN interface

RJ45 connector.

10. USB interfaces

USB, 2 ports. For keyboard, mouse, or peripherals.

To remove USB devices from the instrument, use “Safely Remove Hardware” on Windows taskbar. If it is not used, the instrument may cause the internal USB communication error. If the error occurs, turn the instrument off and disconnect the power cable from it. Leave it about 30 seconds before rebooting it, and connect the power cable again, and then turn the instrument on.

11. Ext Trig terminals

Two BNC connectors, one for trigger input, and one for trigger output. For details about the trigger function, see Keysight B1500 *Programming Guide*.

12. Digital I/O terminal

DSUB 25 pin connector. Can be used for the trigger input/output terminals or an interface to control an external relay circuit and so on. For details, see Keysight B1500 *Programming Guide*. This connector is also used to connect module selector, test fixture, or expander.

 13. Interlock terminal

Used in conjunction with the interlock function of the instrument. If the Interlock terminal is open, maximum SMU output is limited to  $\pm 42$  V and UHVU output is disabled. Be sure to connect this terminal to the interlock circuit of the test fixture or the prober station before performing measurement.

To verify the interlock function, perform the Interlock Open/Close test on the Main Frame tab screen of the EasyEXPERT Configuration window.

---

**WARNING**

**Dangerous voltage, instrument maximum output voltage may appear at High, Force, Guard, and Sense terminals if the Interlock terminal is closed.**

**Une tension dangereuse, une tension de sortie maximale de l'appareil peut apparaître aux bornes High, Force, Guard et Sense si la borne Interlock est fermée.**

---

#### 14. Video output terminal

VGA connector. For an external display. Signal to the built-in LCD is also applied to this terminal.

For the B1505A manufactured before the video output terminal is supported, it is mounted on the position “14a” by upgrading the mainframe.



##### A. GNDU/ADC

Ground unit and A/D converter module. Always installed in the B1505A.



##### B. MFCMU module

The multi frequency capacitance measurement unit (MFCMU) has four coaxial connectors, Lcur, Lpot, Hpot, and Hcur, for the four-terminal pair connection. The Hcur and Hpot have to be connected together at a terminal of the device under test (DUT). Also the Lcur and Lpot have to be connected together at the other terminal of the DUT. Then, the guard lines of four-terminal pair must be connected together.

---

**CAUTION**

Do not apply voltage more than  $\pm 25$  V to the MFCMU input terminals. Failure to heed this caution may result in damage to the module.



##### C. HPSMU, HCSMU, HVSMU, MPSMU, MCSMU module

The high power source/monitor unit (HPSMU) has two triaxial connectors, force and sense, for the Kelvin connections.

The high current source/monitor unit (HCSMU) has the force coaxial connector and the sense triaxial connector, for the Kelvin connections.

The high voltage source/monitor unit (HVSMU) has the force connector.

The medium power source/monitor unit (MPSMU) has two triaxial connectors, force and sense, for the Kelvin connections.

The medium current source/monitor unit (MCSMU) has two triaxial connectors, force and sense, for the Kelvin connections.

In the EasyEXPERT operation mode, the SMUs can be specified by the SMU number. SMU1 is assigned to the SMU at the lowest position. And the following SMU numbers are assigned to the upper SMUs in sequence. Use the SMU number label furnished with the B1505A or equivalent to identify the SMU number.

---

**WARNING**



**To avoid electrical shock and instrument damage, turn the all instruments off before connecting or disconnecting measurement cable.**

**Pour éviter une décharge électrique et un risque d'endommagement de l'appareil, mettez tous les appareils hors tension avant de brancher ou de débrancher le câble de mesure.**

---

**WARNING**



**There are potentially hazardous voltages ( $\pm 10$  kVdc for UHVU,  $\pm 3000$  Vdc for HVSMU,  $\pm 2200$  V pulse for HVMCU,  $\pm 200$  Vdc for HPSMU, and  $\pm 100$  Vdc for MPSMU) present at the High, Force, Guard, and Sense terminals of the instruments. To prevent electrical shock, the following safety precautions must be observed during the use of instruments.**

- **Use three-conductor AC power cable to connect the instrument to an electrical ground (safety ground).**

**For both the N1265A and the N1268A, also connect a wire from an electrical ground (safety ground) to the earthing terminal.**

- **If you use prober and such instead of the test fixture, you must install and connect an interlock circuit that opens the circuit when the shielding box access door is open.**
- **If you change the DUT interface, test fixture, prober, and such, connect an interlock cable to the one actually used.**
- **If the N1268A is used, connect an interlock cable between the B1505A and the N1268A's Interlock Input, and connect an extra interlock cable between the N1268A's Interlock Output and the test fixture or the shielding box.**
- **Confirm periodically that the interlock function works normally.**
- **Before touching the connections on the High, Force, Guard, and Sense terminals in the test fixture or the shielding box, turn the instruments off and discharge any capacitors. If you do *not* turn the instruments off, complete *all* of the following items, regardless of the instrument settings.**
  - **Press the front panel Stop key to set the module output off.**
  - **Confirm that the front panel High Voltage indicator is not lit.**

- **If the N1268A is used, press the High Voltage Enable switch to disable the high voltage output. And confirm that this red switch is not lit.**
- **Open the Interlock terminal (open the fixture cover or the shielding box access door).**
- **Discharge any capacitors connected to a measurement resource.**
- **Warn persons working around the instruments about dangerous conditions.**

---

**WARNING**

Une tension dangereuse (max.  $\pm$  pour UHVU; 10 kVdc, max.  $\pm$  pour HVSMU; 3000 Vdc, max.  $\pm$  pour HVMCU; 2200 Vpulse, max.  $\pm$  pour HPSMU; 200 Vdc, max.  $\pm$  pour MPSMU; 100 Vdc) émanant du dispositif Keysight B1505A peut être sortie aux bornes High, Force, Guard et Sense. Les précautions suivantes doivent être observées contre commotion électrique accidentelle.

- **Utilisez un câble d'alimentation CA à trois conducteurs vers le coupleur secteur (entrée) et branchez l'instrument sur une mise électrique à la terre (prise de terre de sécurité).**
- **Si vous utilisez une sonde ou un outil similaire au lieu de l'équipement de test, vous devez installer et connecter un circuit de sécurité qui ouvre le circuit lorsque la porte d'accès au boîtier de protection est ouverte.**
- **Si vous changez l'interface MST, l'équipement de test, la sonde, ou tout autre élément, connectez un cordon d'enclenchement à celui utilisé actuellement.**
- **Si le N1268A est utilisé, connectez un câble de verrouillage entre le B1505A et Interlock Input du N1268A, puis connectez un câble de verrouillage supplémentaire entre Interlock Output du N1268A et l'équipement de test ou la boîte de protection.**
- **Vérifiez régulièrement le bon fonctionnement de la fonction de sécurité.**
- **Avant de toucher les connexions des bornes High, Force, Guard et Sense, mettez l'instrument hors tension et déchargez tout condensateur du chemin de mesure. Si vous ne mettez pas l'instrument hors tension, effectuez « toutes » les opérations ci-dessous, quels que soient les paramètres de l'instrument.**
  - **Terminez les mesures en appuyant sur la touche Stop ; vérifiez que l'indicateur d'état Measurement est éteint.**
  - **Vérifiez que le témoin High Voltage est éteint.**

Introduction

Rear View

- **Si le N1268A est utilisé, enfoncez le commutateur High Voltage Enable pour désactiver la sortie haute tension. Et confirmez que le commutateur rouge n'est pas allumé.**
  - **Ouvrez la trappe d'accès au boîtier de protection (ouvrez la borne Interlock).**
  - **Déchargez les éventuels condensateurs si la capacité est connectée à une unité SMU.**
  - **Informez les personnes travaillant à proximité de l'instrument des conditions.**
-



## Accessories and Options

Furnished accessories and the available options and accessories for Keysight B1505A are listed in [Table 2-1](#) and [Table 2-2](#).

**Table 2-1**                      **Furnished Accessories**

Description	Quantity
16444A-001 USB keyboard	1
16444A-002 USB mouse	1
16444A-003 Stylus pen	1
16493J Interlock cable	1
16493L GNDU cable	1
16494A Triaxial cable, for the B1505A installed with HPSMU/MPSMU/MCSCMU	2/module
16493S HCSCMU cable, for the B1505A installed with HCSCMU	1/module
16493S-010 HCSCMU Kelvin adapter, for the B1505A installed with HCSCMU	1/module
16493T HVSMU cable, for the B1505A installed with HVSMU	1
N1300A CMU cable, for the B1505A installed with MFCMU	1
16493G Digital I/O cable, furnished with the N1258A, N1259A-300, N1265A, N1266A, or N1268A	1
Extra interlock cable (16493J), furnished with the N1268A	1
SMU number label, for the B1505A installed with SMU	1
Power cable	1
Disk set for Keysight 4155B/4155C/4156B/4156C firmware update	1
EasyEXPERT for PC Software CD	1
License-to-use for EasyEXPERT	

**Table 2-2 Options and Accessories**

<b>Model Number</b>	<b>Option Item</b>	<b>Description</b>
B1505A		Power Device Analyzer/Curve Tracer
	B1505A-015	1.5 m cable length
	B1505A-030	3 m cable length
	B1505A-050	50 Hz power line frequency
	B1505A-060	60 Hz power line frequency
	B1505A-A6J	ANSI Z540 compliant calibration
	B1505A-UK6	Commercial calibration certificate with test data
	B1505A-ABA	Paper manual set, English
	B1505A-ABJ	Paper manual set, Japanese
	B1505A-DR1	Changing DVD-R drive to DVD-ROM drive
	B1505A-1CM	Rack mount kit
B1510A		High Power Source/Monitor Unit module (HPSMU)
B1511B		Medium Power Source/Monitor Unit module (MPSMU)
B1512A		High Current Source/Monitor Unit module (HCSMU)
B1513C		High Voltage Source/Monitor Unit module (HVSMU)
B1514A		Medium Current Source/Monitor Unit module (MCSMU)
B1520A		Multi Frequency Capacitance Measurement Unit module (MFCMU)
N1253A		Accessories for Digital I/O
	N1253A-100	Digital I/O T-cable
	N1253A-200	Digital I/O BNC box
N1254A		Accessories
	N1254A-100	GNDU Kelvin adapter, 1 ea.
	N1254A-103	Triax(m)-BNC(f) adapter, triaxial shield open, 1 ea.
	N1254A-500	HV(jack) connector, panel mount, for soldering, 1 ea.
	N1254A-501	HV(jack)-HV(jack) adapter, panel mount, 1 ea.
	N1254A-502	HV(plug) connector, panel mount, for soldering, 1 ea.
	N1254A-503	BNC(m) to no connector coaxial cable, 1.5 m, 1 ea.
	N1254A-504	HV(jack) to no connector coaxial cable, 1.5 m, 1 ea.
	N1254A-505	HV(plug) to no connector triaxial cable, 1.5 m, 1 ea.
		N1254A-506

<b>Model Number</b>	<b>Option Item</b>	<b>Description</b>
N1254A	N1254A-507	HV(plug)-HV(plug) coaxial cable, 1.5 m, 1 ea.
	N1254A-508	Connection wire, banana-to-banana, red 1 ea.
	N1254A-509	Connection wire, banana-to-banana, black 1 ea
	N1254A-510	Dolphin clip adapter, black 1 ea. and red 1ea.
	N1254A-511	Cable lug adapter, black 1 ea. and red 1ea.
	N1254A-512	SHV(plug)-SHV(plug) cable, 1 ea.
	N1254A-513	SHV(jack)-banana adapter, 1 ea.
	N1254A-514	BNC(m)-BNC(m) adapter, 1 ea.
	N1254A-515	BNC(f)-BNC(m)-BNC(f) adapter, 1 ea.
	N1254A-516	BNC(f)-BNC(f)-BNC(f) adapter, 1 ea.
	N1254A-517	Triax(f)-Triax(m) adapter, shield separated, 1 ea.
	N1254A-518	SHV(plug)-SHV(plug) coaxial cable, 1.5 m, 1 ea.
	N1254A-520	UHV(plug) to no connector cable, 1 m, 1 ea. and SHV(plug) to no connector cable, 1 m, 1 ea.
	N1254A-521	UHV(jack)-UHV(jack) adapter, 1 ea. and SHV(jack)-SHV(jack) adapter, 1 ea.
	N1254A-522	Connection wire, banana-to-banana, maximum 1500 A, 2 ea.
	N1254A-523	Banana to no connector wire, maximum 1500 A, 1 m, 2 ea.
	N1254A-524	500 A Ultra High Current Prober System Cable, 1.8 m, 1 ea.
	N1254A-525	SHV Cable Assy 1.5m - SHV Plug To Open-end, 1 ea.
	N1254A-526	Ultra High Current Cable, 2m, No Connectors At Either End, 1 ea.
	N1254A-527	PTFE Standoff, Jack, 4 ea.
N1254A-528	PTFE Standoff With Banana Plug, 4 ea.	
N1254A-554	Thermocouple, Type K, 75 cm, 2 ea.	
N1254A-556	Test Leads and Connection Kit for Capacitance Test, four 20 cm alligator clip - lug cables, four banana plugs, four nuts, and four spare clips	

Introduction  
Accessories and Options

<b>Model Number</b>	<b>Option Item</b>	<b>Description</b>
N1254A	N1254A-557	Test Leads And Connection Kit For Thermal Test with N1271A, <ul style="list-style-type: none"> <li>• six 20 cm small alligator clip - lug cables, six banana plugs, six nuts, and six spare clips</li> <li>• two 20 cm large alligator clip - lug cables, two banana plugs, and two nuts</li> <li>• four 30 cm small alligator clip - lug cables, four banana plugs, four nuts, and four spare clips</li> <li>• two 30 cm large alligator clip - lug cables, two banana plugs, and two nuts</li> </ul>
	N1254A-558	SHV cable, 3 m, 1 ea.
N1258A		Module Selector
N1259A		Test Fixture
	N1259A-001	Test fixture, built-in HPSMU protection adapter, built-in GNDU protection adapter, four black connection wire, and six red connection wire, and N1259A-010, 1 ea.
	N1259A-010	Kelvin socket module for inline package device
	N1259A-011	Universal socket module for power device
	N1259A-012	Blank PTFE board
	N1259A-013	Curve tracer test adapter socket module
	N1259A-014	Gate charge socket module
	N1259A-020	Built-in high voltage bias-tee (furnished with two SHV-SHV cables and two SHV-banana adapters)
	N1259A-021	1 M $\Omega$ resistor box
	N1259A-022	100 k $\Omega$ resistor box
N1259A	N1259A-030	1 k $\Omega$ resistor box
	N1259A-035	Universal resistor box
	N1259A-300	Built-in module selector
N1260A		High voltage bias-tee

<b>Model Number</b>	<b>Option Item</b>	<b>Description</b>
N1261A		Protection Adapter
	N1261A-001	HPSMU protection adapter, Triax(f)
	N1261A-002	GNDU protection adapter, BNC(f)
	N1261A-003	HPSMU protection adapter, HV(jack)
	N1261A-004	GNDU protection adapter, SHV(jack)
N1262A		High voltage resistor box
	N1262A-001	1 M $\Omega$ resistor box, SHV(jack)
	N1262A-002	100 k $\Omega$ resistor box, SHV(jack)
	N1262A-010	1 k $\Omega$ resistor box, Triax(f)
	N1262A-011	1 k $\Omega$ resistor box, SHV(jack)
	N1262A-020	Universal resistor box, Triax(f)
	N1262A-021	Universal resistor box, SHV(jack)
	N1262A-023	Universal resistor box, UHV(jack), with UHV(plug)-UHV(plug) cable, 1.5 m
N1262A-036	50 $\Omega$ termination adapter	
N1265A		Ultra High Current Expander/Fixture
	N1265A-001	Test fixture, built-in 500 A ultra high current expander, built-in module selector, four black connection wire, and four red connection wire, N1265A-002, 1 ea. and N1265A-010, 1 ea.
	N1265A-002	Blank silicon plate
	N1265A-010	Kelvin socket module for inline package device, maximum 500 A (furnished with two high current connection wire (18 cm), two sense connection wire (18 cm), and two gate connection wire (25 cm))
	N1265A-011	Universal socket module for power device, maximum 1500 A
	N1265A-013	Curve tracer test adapter socket module
	N1265A-014	Gate charge socket module
	N1265A-015	Built-in 1500 A ultra high current expander (replaced with built-in 500 A ultra high current expander)
	N1265A-035	Universal resistor box
	N1265A-040	Protection adapter for Gate/SMU

Introduction  
Accessories and Options

<b>Model Number</b>	<b>Option Item</b>	<b>Description</b>
N1265A	N1265A-041	Thermocouple, Type K, 2 ea.
	N1265A-045	Container for protection adapter and bias-tee
	N1265A-A6J	ANSI Z540 compliant calibration
	N1265A-UK6	Commercial calibration certificate with test data
N1266A		HVSMU Current Expander
N1267A		HVSMU/HCSMU Fast Switch
N1268A		Ultra High Voltage Expander
N1269A		Ultra High Voltage Connection Adapter
N1271A		Thermal Test Enclosure
	N1271A-001	Thermal plate compatible enclosure for N1259A/N1265A
	N1271A-002	Thermostream compatible enclosure for N1265A (3kV IV)
	N1271A-005	Thermostream compatible enclosure for N1265A (3kV IV, CV & 10kV)
N1272A		Device Capacitance Selector
N1273A		Capacitance Test Fixture
	N1273A-011	Universal Socket Module
	N1273A-013	Curve Tracer Test Adapter Socket Module
N1274A		On-Wafer Gate Charge measurement adapter/selector for 20A/3kV
N1275A		On-Wafer Gate Charge measurement adapter for N1265A
N1300A		CMU cable
	N1300A-001	1.5 m length
	N1300A-002	3 m length
16444A		Accessories for B1500 series
	16444A-001	USB keyboard
	16444A-002	USB mouse
	16444A-003	Stylus pen
16493G		Digital I/O connection cable
	16493G-001	1.5 m length
	16493G-002	3 m length

<b>Model Number</b>	<b>Option Item</b>	<b>Description</b>
16493J		Interlock cable
	16493J-001	1.5 m length
	16493J-002	3 m length
	16493J-003	5 m length
16493K		Kelvin triaxial cable
	16493K-001	1.5 m length
	16493K-002	3 m length
16493L		GNDU cable
	16493L-001	1.5 m length
	16493L-002	3 m length
	16493L-003	5 m length
16493S		Accessories for HCSMU
	16493S-001	HCSMU cable, Triax(m)-Triax(m) and BNC(m)-BNC(m), 1.5 m length
	16493S-002	HCSMU cable, Triax(m)-Triax(m) and BNC(m)-BNC(m), 3 m length
	16493S-010	HCSMU Kelvin adapter
	16493S-011	HCSMU non-Kelvin adapter
	16493S-020	Dual HCSMU Kelvin combination adapter (Adapter, 40 A, when connecting to wafer prober directly without N1258A selector)
	16493S-021	Dual HCSMU combination adapter (Adapter, 40 A, when not connecting to wafer prober directly)
16493T		HVSMU cable, HV(plug)-HV(plug) triaxial cable
	16493T-001	1.5 m length
	16493T-002	3 m length
16493U		High current coaxial cable, BNC(m)-BNC(m)
	16493U-001	1.5 m length
	16493U-002	3 m length
16493V		UHVU cable set, UHV(plug)-UHV(plug) and SHV(plug)-SHV(plug)
	16493V-001	1.5 m length
	16493V-002	3 m length

Introduction  
Accessories and Options

<b>Model Number</b>	<b>Option Item</b>	<b>Description</b>
16494A		Triaxial cable
	16494A-001	1.5 m length
	16494A-002	3 m length
	16494A-003	80 cm length
	16494A-004	40 cm length
	16494A-005	4 m length



---

## Measurement Resources

Keysight B1505A can be equipped with the following measurement resources.

- “GNDU - Ground Unit”
- “HPSMU - High Power SMU”
- “HCSMU - High Current SMU”
- “HVSMU - High Voltage SMU”
- “MPSMU - Medium Power SMU”
- “MCSMU - Medium Current SMU”
- “HVMCU - High Voltage Medium Current Unit”
- “UHCU - Ultra High Current Unit”
- “UHVU - Ultra High Voltage Unit”
- “MFCMU - Multi Frequency CMU”

See Keysight EasyEXPERT *User's Guide* for the functions available for Keysight EasyEXPERT software. See Keysight B1500 *Programming Guide* for the functions available for the GPIB remote mode.

### GNDU - Ground Unit

The B1505A is equipped with the ground unit (GNDU). The GNDU is a 0 V constant voltage source, and used for the reference of measurement ground. Also the GNDU can sink up to  $\pm 4.2$  A, so it is effective for using the HPSMU, MPSMU, and HVSMU. When the HCSMU, MCSMU, HVMCU, or UHCU is used, the GNDU must be connected to the Low side to apply the reference zero voltage. The GNDU is not used with the UHVU. **Figure 2-1** is a simplified circuit diagram of GNDU.

**Figure 2-1**

#### Simplified GNDU Circuit Diagram

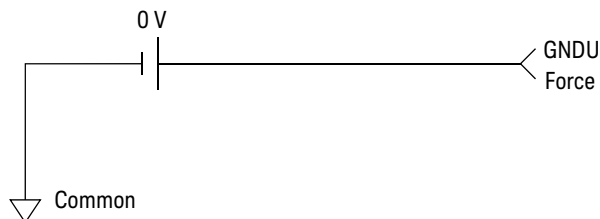

## About SMU

Source/monitor unit (SMU) can apply DC voltage or current, and can measure DC current or voltage. **Figure 2-2** is a simplified SMU circuit diagram.

The HPSMU and MPSMU can perform the following operations:

- Apply voltage and measures current or voltage
- Apply current and measures current or voltage

The HCSMU, MCSMU, and HVSMU can perform the following operations:

- Apply voltage and measures current and/or voltage
- Apply current and measures current and/or voltage

---

**NOTE**

---

To select the SMU operation mode in the GPIB remote condition, enter the CMM command.

**Figure 2-2** Simplified SMU Circuit Diagram

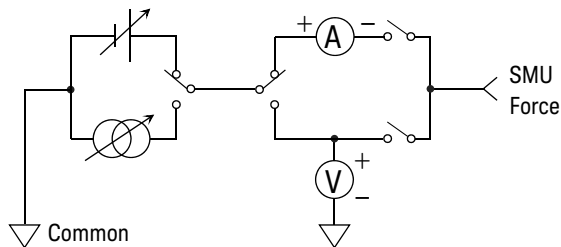

## Compliance

The SMU has a compliance feature that limits output voltage or current to prevent damage to the device under test. When the SMU applies voltage, you can specify current compliance. When the SMU applies current, you can specify voltage compliance. For details about the compliance, see *Keysight EasyEXPERT User's Guide*.

## HPSMU - High Power SMU

This section describes typical specification of the high power source/monitor unit (HPSMU). Maximum four modules can be installed in one mainframe. The total number of installed HPSMU and HCSMU modules can not exceed 4.

- Maximum voltage, current, output power:  $\pm 200$  V,  $\pm 1$  A, 20 W
- Minimum range: 2 V, 1 nA
- Output/measurement value and resolution: see [Table 2-3](#) to [Table 2-6](#).

Figure 2-3

HPSMU Output and Measurement Ranges

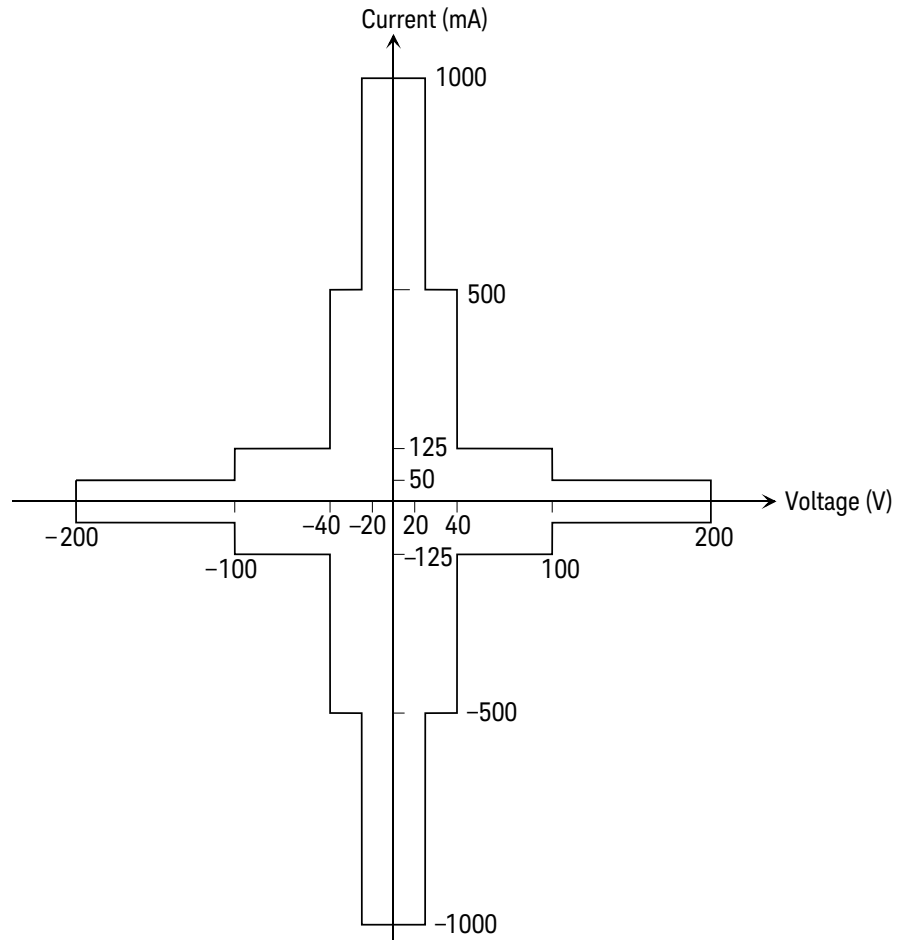

**Table 2-3 HPSMU Output Voltage Ranges and Resolutions**

Range	Output Value	Setting Resolution	Maximum Current
2 V	$0 \leq  V  \leq 2 \text{ V}$	100 $\mu\text{V}$	$\pm 1000 \text{ mA}$
20 V	$0 \leq  V  \leq 20 \text{ V}$	1 mV	$\pm 1000 \text{ mA}$
40 V	$0 \leq  V  \leq 40 \text{ V}$	2 mV	$\pm 500 \text{ mA}$
100 V	$0 \leq  V  \leq 100 \text{ V}$	5 mV	$\pm 125 \text{ mA}$
200 V	$0 \leq  V  \leq 200 \text{ V}$	10 mV	$\pm 50 \text{ mA}$

**Table 2-4 HPSMU Output Current Ranges and Resolutions**

Range	Output Value	Setting Resolution	Maximum Voltage
1 nA	$0 \leq  I  \leq 1.15 \text{ nA}$	50 fA	$\pm 200 \text{ V}$
10 nA	$0 \leq  I  \leq 11.5 \text{ nA}$	500 fA	$\pm 200 \text{ V}$
100 nA	$0 \leq  I  \leq 115 \text{ nA}$	5 pA	$\pm 200 \text{ V}$
1 $\mu\text{A}$	$0 \leq  I  \leq 1.15 \mu\text{A}$	50 pA	$\pm 200 \text{ V}$
10 $\mu\text{A}$	$0 \leq  I  \leq 11.5 \mu\text{A}$	500 pA	$\pm 200 \text{ V}$
100 $\mu\text{A}$	$0 \leq  I  \leq 115 \mu\text{A}$	5 nA	$\pm 200 \text{ V}$
1 mA	$0 \leq  I  \leq 1.15 \text{ mA}$	50 nA	$\pm 200 \text{ V}$
10 mA	$0 \leq  I  \leq 11.5 \text{ mA}$	500 nA	$\pm 200 \text{ V}$
100 mA	$0 \leq  I  \leq 50 \text{ mA}$	5 $\mu\text{A}$	$\pm 200 \text{ V}$
	$50 \text{ mA} <  I  \leq 115 \text{ mA}$	5 $\mu\text{A}$	$\pm 100 \text{ V}$
1 A	$0 \leq  I  \leq 50 \text{ mA}$	50 $\mu\text{A}$	$\pm 200 \text{ V}$
	$50 \text{ mA} <  I  \leq 125 \text{ mA}$	50 $\mu\text{A}$	$\pm 100 \text{ V}$
	$125 \text{ mA} <  I  \leq 500 \text{ mA}$	50 $\mu\text{A}$	$\pm 40 \text{ V}$
	$500 \text{ mA} <  I  \leq 1 \text{ A}$	50 $\mu\text{A}$	$\pm 20 \text{ V}$

**Table 2-5 HPSMU Measurement Voltage Values and Resolutions**

Range	Measurement Value <sup>a</sup>	Measurement Resolutions	
		High Speed ADC	High Resolution ADC
2 V	$0 \leq  V  \leq 2.2 \text{ V}$	100 $\mu\text{V}$	2 $\mu\text{V}$
20 V	$0 \leq  V  \leq 22 \text{ V}$	1 mV	20 $\mu\text{V}$
40 V	$0 \leq  V  \leq 44 \text{ V}$	2 mV	40 $\mu\text{V}$
100 V	$0 \leq  V  \leq 110 \text{ V}$	5 mV	100 $\mu\text{V}$
200 V	$0 \leq  V  \leq 200 \text{ V}$	10 mV	200 $\mu\text{V}$

**Table 2-6 HPSMU Measurement Current Values and Resolutions**

Range	Measurement Value <sup>a</sup>	Measurement Resolutions	
		High Speed ADC	High Resolution ADC
1 nA	$0 \leq  I  \leq 1.15 \text{ nA}$	50 fA	10 fA
10 nA	$0 \leq  I  \leq 11.5 \text{ nA}$	500 fA	10 fA
100 nA	$0 \leq  I  \leq 115 \text{ nA}$	5 pA	100 fA
1 $\mu\text{A}$	$0 \leq  I  \leq 1.15 \text{ }\mu\text{A}$	50 pA	1 pA
10 $\mu\text{A}$	$0 \leq  I  \leq 11.5 \text{ }\mu\text{A}$	500 pA	10 pA
100 $\mu\text{A}$	$0 \leq  I  \leq 115 \text{ }\mu\text{A}$	5 nA	100 pA
1 mA	$0 \leq  I  \leq 1.15 \text{ mA}$	50 nA	1 nA
10 mA	$0 \leq  I  \leq 11.5 \text{ mA}$	500 nA	10 nA
100 mA	$0 \leq  I  \leq 115 \text{ mA}$	5 $\mu\text{A}$	100 nA
1 A	$0 \leq  I  \leq 1 \text{ A}$	50 $\mu\text{A}$	1 $\mu\text{A}$

a. This column is applied to the auto ranging or the limited auto ranging. For fixed ranging, maximum measurement value is **Range** column value.

## HCSMU - High Current SMU

This section describes typical specification of the high current source/monitor unit (HCSMU). Maximum two modules can be installed in one mainframe. Using two modules (DHCSMU, dual HCSMU) can expand the maximum current up to  $\pm 40$  A (pulse),  $\pm 2$  A (DC). The total number of installed HPSMU and HCSMU modules can not exceed 4.

- Maximum current by one module:  $\pm 20$  A (pulse),  $\pm 1$  A (DC)
- Maximum voltage by one module:  $\pm 40$  V,  $\pm 20$  V only for the pulse over  $\pm 1$  A
- Maximum output power by one module: 40 W
- Minimum range: 0.2 V, 10  $\mu$ A
- Minimum pulse width: 50  $\mu$ s
- Output/measurement value and resolution: see [Table 2-7](#) and [Table 2-8](#).

---

**NOTE**

Do not put any conductor on the HCSMU Low Force and Low Sense terminals, outer conductor of the coaxial connectors. Putting conductor of circuit common, chassis ground, or any potential on causes the measurement error.

---

**Figure 2-4 HCSMU Output and Measurement Ranges by One Module**

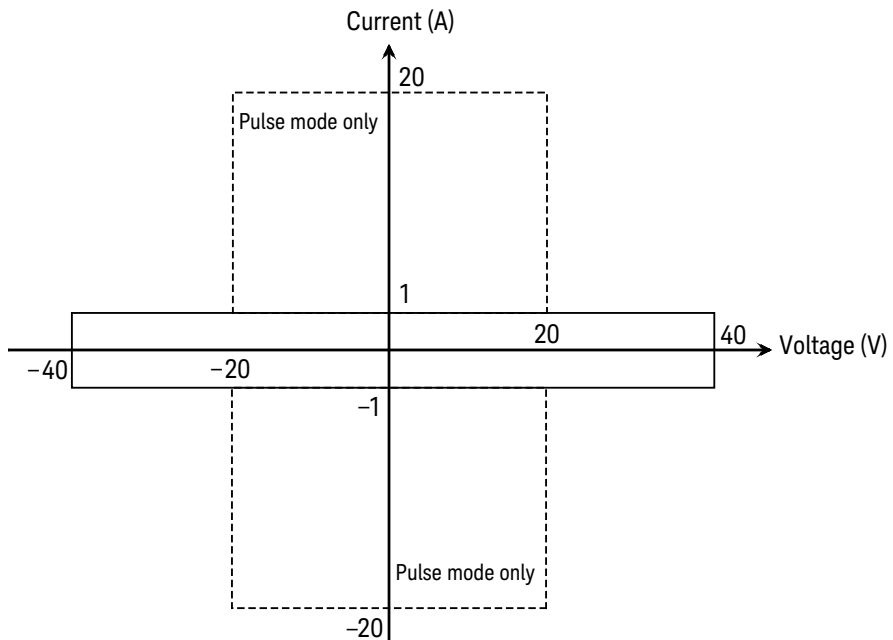

**Table 2-7 HCSMU Voltage Ranges and Resolutions (HCSMU / DHCSMU)**

Range	Output Value and Measurement Value	Setting/Measurement Resolution	Maximum Current	Maximum Pulse Base Value
0.2 V	$0 \leq  V  \leq 0.2 \text{ V}$	200 nV	$\pm 20 \text{ A} / \pm 40 \text{ A}$	$\pm 0.2 \text{ V}$
2 V	$0 \leq  V  \leq 2 \text{ V}$	2 $\mu\text{V}$	$\pm 20 \text{ A} / \pm 40 \text{ A}$	$\pm 2 \text{ V}$
20 V	$0 \leq  V  \leq 20 \text{ V}$	20 $\mu\text{V}$	$\pm 20 \text{ A} / \pm 40 \text{ A}$	$\pm 20 \text{ V}$
40 V	$0 \leq  V  \leq 40 \text{ V}$	40 $\mu\text{V}$	$\pm 1 \text{ A} / \pm 2 \text{ A}$	$\pm 40 \text{ V}$

**Table 2-8 HCSMU Current Ranges and Resolutions**

Range	Output Value and Measurement Value	Setting/Measurement Resolution	Maximum Voltage	Maximum Pulse Base Value
10 $\mu\text{A}$	$0 \leq  I  \leq 11.5 \mu\text{A}$	10 pA	$\pm 40 \text{ V}$	$\pm 10 \mu\text{A}$
100 $\mu\text{A}$	$0 \leq  I  \leq 115 \mu\text{A}$	100 pA	$\pm 40 \text{ V}$	$\pm 100 \mu\text{A}$
1 mA	$0 \leq  I  \leq 1.15 \text{ mA}$	1 nA	$\pm 40 \text{ V}$	$\pm 1 \text{ mA}$
10 mA	$0 \leq  I  \leq 11.5 \text{ mA}$	10 nA	$\pm 40 \text{ V}$	$\pm 10 \text{ mA}$
100 mA	$0 \leq  I  \leq 115 \text{ mA}$	100 nA	$\pm 40 \text{ V}$	$\pm 100 \text{ mA}$
1 A	$0 \leq  I  \leq 1.15 \text{ A}^{\text{a}}$	1 $\mu\text{A}$	$\pm 40 \text{ V}$	$\pm 1 \text{ A}$
2 A	$0 \leq  I  \leq 2.02 \text{ A}^{\text{b}}$	2 $\mu\text{A}$	$\pm 40 \text{ V}$	$\pm 2 \text{ A}$
20 A	$0 \leq  I  \leq 20 \text{ A}$	20 $\mu\text{A}$	$\pm 20 \text{ V}$	$\pm 100 \text{ mA}$
40 A	$0 \leq  I  \leq 40 \text{ A}$	40 $\mu\text{A}$	$\pm 20 \text{ V}$	$\pm 200 \text{ mA}$

a. Maximum value is 1 A for DC output or measurement by HCSMU.

b. Maximum value is 2 A for DC output or measurement.

**NOTE 40 A range and 2 A range**

The 40 A range and the 2 A range are available when two HCSMU modules are installed in the B1505A and connected to the 16493S-020 Dual HCSMU Kelvin combination adapter or the 16493S-021 Dual HCSMU combination adapter. Two HCSMU modules can be the DHCSMU which supports  $\pm 40 \text{ A}$  (pulse),  $\pm 2 \text{ A}$  (DC). Then the 20 A range is not supported.

When the compliance value is set to  $> 1 \text{ A}$  or  $< -1 \text{ A}$ , the current measurement range is fixed to the compliance range.

## HVSMU - High Voltage SMU

This section describes typical specification of the high voltage source/monitor unit (HVSMU). Maximum five B1513C modules can be installed in one mainframe.

- Maximum voltage/current: 3000 V/4 mA, -3000 V/-4 mA, 1500 V/8 mA, or -1500 V/-8 mA
- Maximum output power: 12 W (at one module used)
- Minimum range: 200 V, 1 nA
- Output/measurement value and resolution: see [Table 2-9](#) and [Table 2-10](#).

---

**NOTE**

---

Multiple B1513A/B1513B HVSMU modules cannot be installed in one mainframe. The B1513A HVSMU cannot be used with the N1267A HVSMU/HCSMU Fast Switch.

**Figure 2-5 HVSMU Output and Measurement Ranges**

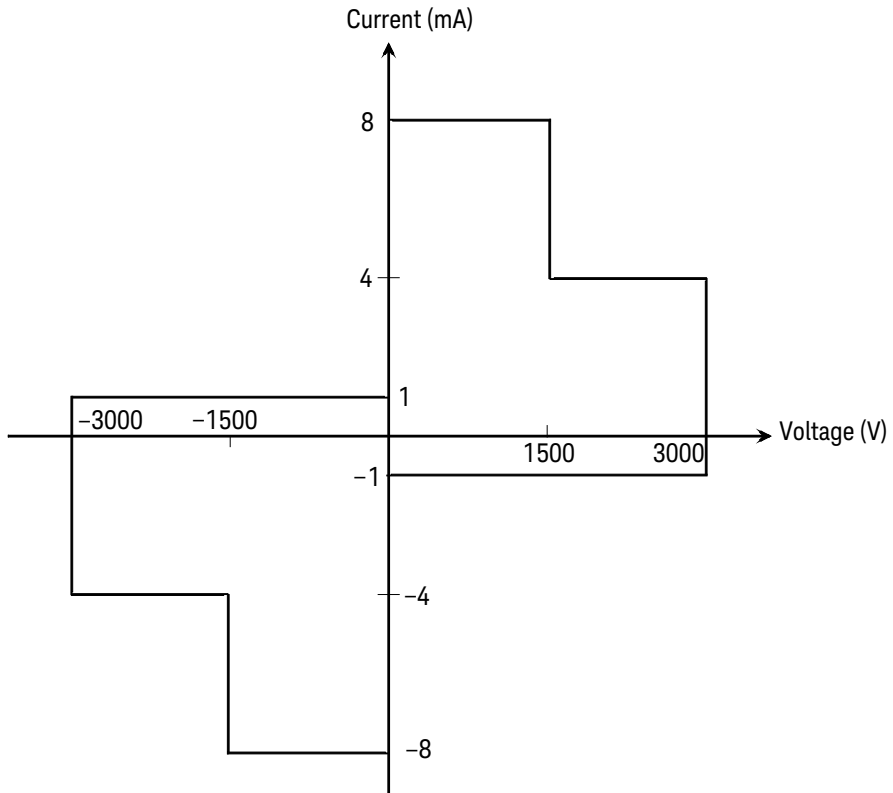



**CAUTION**

Never connect the HVSMU Force and Guard terminals to any output, including circuit common, chassis ground, or any other measurement resource such as SMU. Connecting other measurement resource may damage the connected one.

**Table 2-9 HVSMU Voltage Ranges and Resolutions**

Range	Output Value and Measurement Value	Setting/ Measurement Resolution	Maximum Current  Imax
200 V	$0 \leq  V  \leq 200 \text{ V}$	200 $\mu\text{V}$	8 mA
500 V	$0 \leq  V  \leq 500 \text{ V}$	500 $\mu\text{V}$	8 mA
1500 V	$0 \leq  V  \leq 1500 \text{ V}$	1.5 mV	8 mA
3000 V	$0 \leq  V  \leq 3000 \text{ V}$	3 mV	4 mA

**Table 2-10 HVSMU Current Ranges and Resolutions**

Range	Output Value and Measurement Value	Setting/ Measurement Resolution	Maximum Voltage  Vmax
1 nA <sup>a</sup>	$0 \leq  I  \leq 1.15 \text{ nA}$	10 fA	3000 V
10 nA	$0 \leq  I  \leq 11.5 \text{ nA}$	100 fA	3000 V
100 nA	$0 \leq  I  \leq 115 \text{ nA}$	100 fA	3000 V
1 $\mu\text{A}$	$0 \leq  I  \leq 1.15 \text{ } \mu\text{A}$	1 pA	3000 V
10 $\mu\text{A}$	$0 \leq  I  \leq 11.5 \text{ } \mu\text{A}$	10 pA	3000 V
100 $\mu\text{A}$	$0 \leq  I  \leq 115 \text{ } \mu\text{A}$	100 pA	3000 V
1 mA	$0 \leq  I  \leq 1.15 \text{ mA}$	1 nA	3000 V
10 mA	$0 \leq  I  \leq 8 \text{ mA}$	10 nA	1500 V
	$0 \leq  I  \leq 4 \text{ mA}$		3000 V

a. DC only



**Table 2-11**                      **MPSMU Output Voltage Ranges and Resolutions**

<b>Range</b>	<b>Output Value</b>	<b>Setting Resolution</b>	<b>Maximum Current</b>
0.5 V	$0 \leq  V  \leq 0.5 \text{ V}$	25 $\mu\text{V}$	$\pm 100 \text{ mA}$
2 V	$0 \leq  V  \leq 2 \text{ V}$	100 $\mu\text{V}$	$\pm 100 \text{ mA}$
5 V	$0 \leq  V  \leq 5 \text{ V}$	250 $\mu\text{V}$	$\pm 100 \text{ mA}$
20 V	$0 \leq  V  \leq 20 \text{ V}$	1 mV	$\pm 100 \text{ mA}$
40 V	$0 \leq  V  \leq 20 \text{ V}$	2 mV	$\pm 100 \text{ mA}$
	$20 \text{ V} <  V  \leq 40 \text{ V}$	2 mV	$\pm 50 \text{ mA}$
100 V	$0 \leq  V  \leq 20 \text{ V}$	5 mV	$\pm 100 \text{ mA}$
	$20 \text{ V} <  V  \leq 40 \text{ V}$	5 mV	$\pm 50 \text{ mA}$
	$40 \text{ V} <  V  \leq 100 \text{ V}$	5 mV	$\pm 20 \text{ mA}$

**Table 2-12**                      **MPSMU Output Current Ranges and Resolutions**

<b>Range</b>	<b>Output Value</b>	<b>Setting Resolution</b>	<b>Maximum Voltage</b>
1 nA	$0 \leq  I  \leq 1.15 \text{ nA}$	50 fA	$\pm 100 \text{ V}$
10 nA	$0 \leq  I  \leq 11.5 \text{ nA}$	500 fA	$\pm 100 \text{ V}$
100 nA	$0 \leq  I  \leq 115 \text{ nA}$	5 pA	$\pm 100 \text{ V}$
1 $\mu\text{A}$	$0 \leq  I  \leq 1.15 \mu\text{A}$	50 pA	$\pm 100 \text{ V}$
10 $\mu\text{A}$	$0 \leq  I  \leq 11.5 \mu\text{A}$	500 pA	$\pm 100 \text{ V}$
100 $\mu\text{A}$	$0 \leq  I  \leq 115 \mu\text{A}$	5 nA	$\pm 100 \text{ V}$
1 mA	$0 \leq  I  \leq 1.15 \text{ mA}$	50 nA	$\pm 100 \text{ V}$
10 mA	$0 \leq  I  \leq 11.5 \text{ mA}$	500 nA	$\pm 100 \text{ V}$
100 mA	$0 \leq  I  \leq 20 \text{ mA}$	5 $\mu\text{A}$	$\pm 100 \text{ V}$
	$20 \text{ mA} <  I  \leq 50 \text{ mA}$	5 $\mu\text{A}$	$\pm 40 \text{ V}$
	$50 \text{ mA} <  I  \leq 100 \text{ mA}$	5 $\mu\text{A}$	$\pm 20 \text{ V}$

**Table 2-13 MPSMU Measurement Voltage Values and Resolutions**

Range	Measurement Value <sup>a</sup>	Measurement Resolutions	
		High Speed ADC	High Resolution ADC
0.5 V	$0 \leq  V  \leq 0.55 \text{ V}$	25 $\mu\text{V}$	0.5 $\mu\text{V}$
2 V	$0 \leq  V  \leq 2.2 \text{ V}$	100 $\mu\text{V}$	2 $\mu\text{V}$
5 V	$0 \leq  V  \leq 5.5 \text{ V}$	250 $\mu\text{V}$	5 $\mu\text{V}$
20 V	$0 \leq  V  \leq 22 \text{ V}$	1 mV	20 $\mu\text{V}$
40 V	$0 \leq  V  \leq 44 \text{ V}$	2 mV	40 $\mu\text{V}$
100 V	$0 \leq  V  \leq 100 \text{ V}$	5 mV	100 $\mu\text{V}$

**Table 2-14 MPSMU Measurement Current Values and Resolutions**

Range	Measurement Value <sup>a</sup>	Measurement Resolutions	
		High Speed ADC	High Resolution ADC
1 nA	$0 \leq  I  \leq 1.15 \text{ nA}$	50 fA	10 fA
10 nA	$0 \leq  I  \leq 11.5 \text{ nA}$	500 fA	10 fA
100 nA	$0 \leq  I  \leq 115 \text{ nA}$	5 pA	100 fA
1 $\mu\text{A}$	$0 \leq  I  \leq 1.15 \text{ }\mu\text{A}$	50 pA	1 pA
10 $\mu\text{A}$	$0 \leq  I  \leq 11.5 \text{ }\mu\text{A}$	500 pA	10 pA
100 $\mu\text{A}$	$0 \leq  I  \leq 115 \text{ }\mu\text{A}$	5 nA	100 pA
1 mA	$0 \leq  I  \leq 1.15 \text{ mA}$	50 nA	1 nA
10 mA	$0 \leq  I  \leq 11.5 \text{ mA}$	500 nA	10 nA
100 mA	$0 \leq  I  \leq 100 \text{ mA}$	5 $\mu\text{A}$	100 nA

a. This column is applied to the auto ranging or the limited auto ranging.  
For fixed ranging, maximum measurement value is **Range** column value.

## MCSMU - Medium Current SMU

This section describes typical specification of the medium current source/monitor unit (MCSMU). Maximum six modules can be installed in one mainframe.

- Maximum current:  $\pm 1$  A (pulse),  $\pm 0.1$  A (DC)
- Maximum voltage:  $\pm 30$  V
- Maximum output power: 30 W (pulse), 3 W (DC)
- Minimum range: 0.2 V, 10  $\mu$ A
- Minimum pulse width: 10  $\mu$ s
- Output/measurement value and resolution: see [Table 2-15](#) and [Table 2-16](#).

Figure 2-7

### MCSMU Output and Measurement Ranges

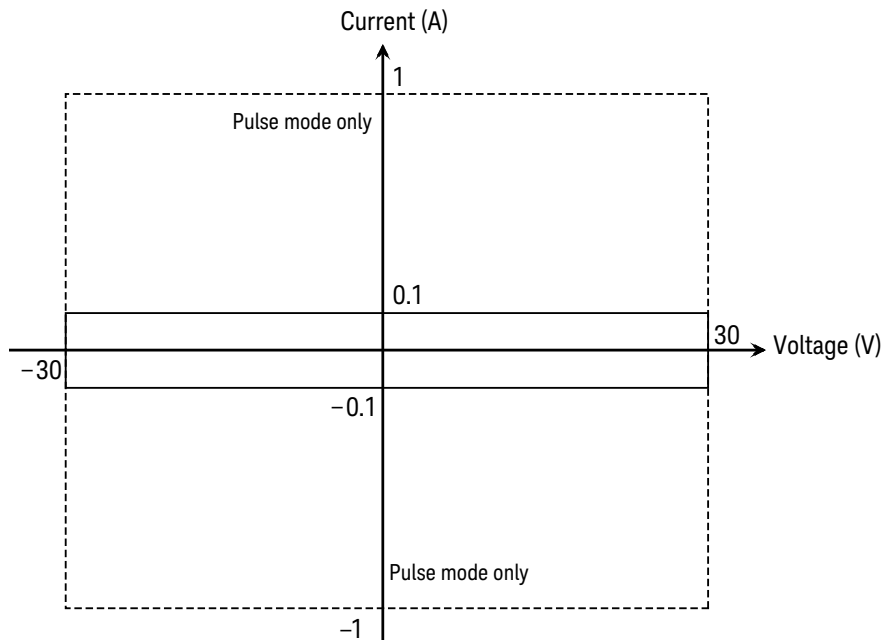

**Table 2-15 MCSMU Voltage Ranges and Resolutions**

Range	Output Value and Measurement Value	Setting/ Measurement Resolution	Maximum Current	Maximum Pulse Base Value
0.2 V	$0 \leq  V  \leq 0.2 \text{ V}$	200 nV	100 mA, 1 A <sup>a</sup>	$\pm 0.2 \text{ V}$
2 V	$0 \leq  V  \leq 2 \text{ V}$	2 $\mu\text{V}$		$\pm 2 \text{ V}$
20 V	$0 \leq  V  \leq 20 \text{ V}$	20 $\mu\text{V}$		$\pm 20 \text{ V}$
40 V	$0 \leq  V  \leq 30 \text{ V}$	40 $\mu\text{V}$		$\pm 30 \text{ V}$

a. For pulse.

**Table 2-16 MCSMU Current Ranges and Resolutions**

Range	Output Value and Measurement Value	Setting/ Measurement Resolution	Maximum Voltage	Maximum Pulse Base Value
10 $\mu\text{A}$	$0 \leq  I  \leq 11.5 \mu\text{A}$	10 pA	$\pm 30 \text{ V}$	$\pm 10 \mu\text{A}$
100 $\mu\text{A}$	$0 \leq  I  \leq 115 \mu\text{A}$	100 pA		$\pm 100 \mu\text{A}$
1 mA	$0 \leq  I  \leq 1.15 \text{ mA}$	1 nA		$\pm 1 \text{ mA}$
10 mA	$0 \leq  I  \leq 11.5 \text{ mA}$	10 nA		$\pm 10 \text{ mA}$
100 mA	$0 \leq  I  \leq 100 \text{ mA}$ , $0 \leq  I  \leq 115 \text{ mA}$ <sup>a</sup>	100 nA		$\pm 100 \text{ mA}$
1 A <sup>b</sup>	$0 \leq  I  \leq 1 \text{ A}$	1 $\mu\text{A}$		$\pm 50 \text{ mA}$

a. For pulse.

b. For pulse. Maximum pulse width and duty cycle are 100 ms and 5 % respectively.

## HVMCU - High Voltage Medium Current Unit

The high voltage medium current unit (HVMCU) is configured by the Keysight N1266A HVSMU current expander, the HVSMU module, and two MCSMU/HCSMU modules. Typical specifications of the HVMCU are shown below.

- Output: voltage pulse
- Measurement: current or voltage
- Maximum voltage:  $\pm 2200$  V, or  $\pm 1500$  V for 2 A compliance range
- Minimum pulse width: 10  $\mu$ s
- Minimum pulse period: 5 ms
- Output/measurement value and resolution: see [Table 2-17](#) and [Table 2-18](#).

---

**CAUTION**

---

Never connect the HVMCU High terminal to any output, including circuit common, chassis ground, or any other measurement resource such as SMU. Connecting other measurement resource may damage the connected one.

Figure 2-8

HVMCU Output and Measurement Ranges

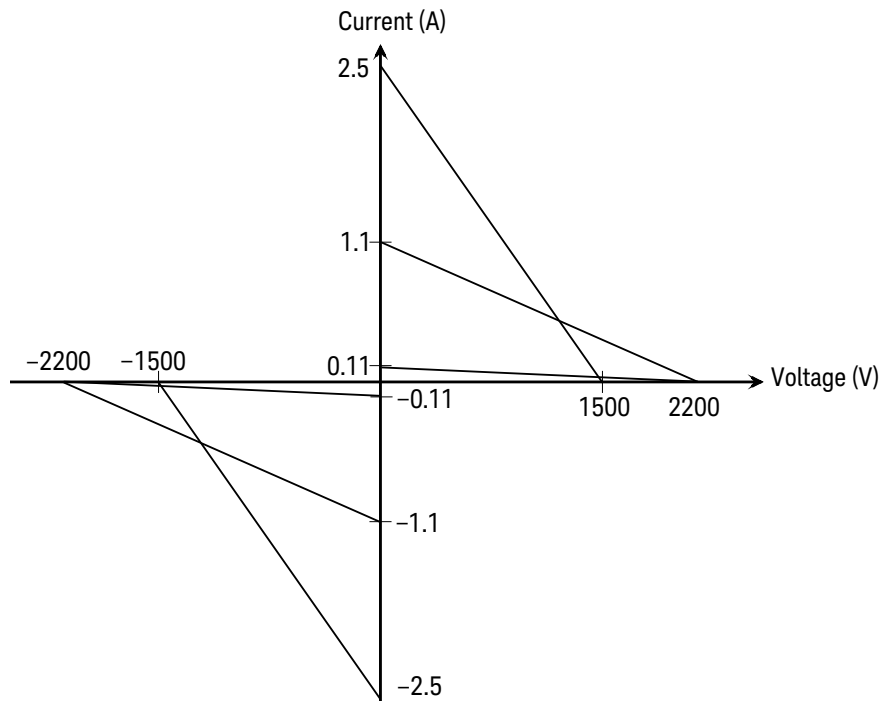

**Table 2-17 HVMCU Voltage Ranges and Resolutions**

Range	Output Value <sup>a</sup>	Measurement Value <sup>b</sup>	Setting/ Measurement Resolution	Compliance Range	Maximum Current
1500 V	$0 \leq  V  \leq 1500 \text{ V}$	$0 \leq  V  \leq 2200 \text{ V}$	1.5 mV/3 mV <sup>b</sup>	2 A	$\pm 2.5 \text{ A}$
3000 V	$0 \leq  V  \leq 2200 \text{ V}$		3 mV/3 mV	1 A	$\pm 1.1 \text{ A}$
				100 mA	$\pm 110 \text{ mA}$

a. Pulse base value is always 0 V.

b. Measurement is performed by the 3000 V measurement range.

**Table 2-18 HVMCU Current Ranges and Resolutions**

Range	Output Value	Measurement Value	Setting Resolution	Measurement Resolution	Maximum Voltage
100 mA	—	$0 \leq  I  \leq 0.11 \text{ A}$	—	200 nA	$\pm 2200 \text{ V}$
2 A	—	$0 \leq  I  \leq 1.1 \text{ A}$	—	4 $\mu\text{A}$	$\pm 2200 \text{ V}$
	—	$0 \leq  I  \leq 2.5 \text{ A}$	—	4 $\mu\text{A}$	$\pm 1500 \text{ V}$



## UHCU - Ultra High Current Unit

The ultra high current unit (UHCU) is configured by the Keysight N1265A ultra high current expander/fixture and two MCSMU/HCSMU modules. Typical specifications of the UHCU are shown below.

- Output: voltage pulse or current pulse
- Measurement: current or voltage
- Maximum current:  $\pm 500$  A, or  $\pm 1500$  A for the option N1265A-015
- Maximum voltage:  $\pm 60$  V
- Maximum power: 7.5 kW for 500 A range, or 22.5 kW for 2000 A range
- Minimum pulse width: 10  $\mu$ s
- Maximum pulse duty: 0.4 % for 500 A range, or 0.1 % for 2000 A range
- Output/measurement value and resolution: see [Table 2-19](#) and [Table 2-20](#).

Figure 2-9

### UHCU Output and Measurement Ranges

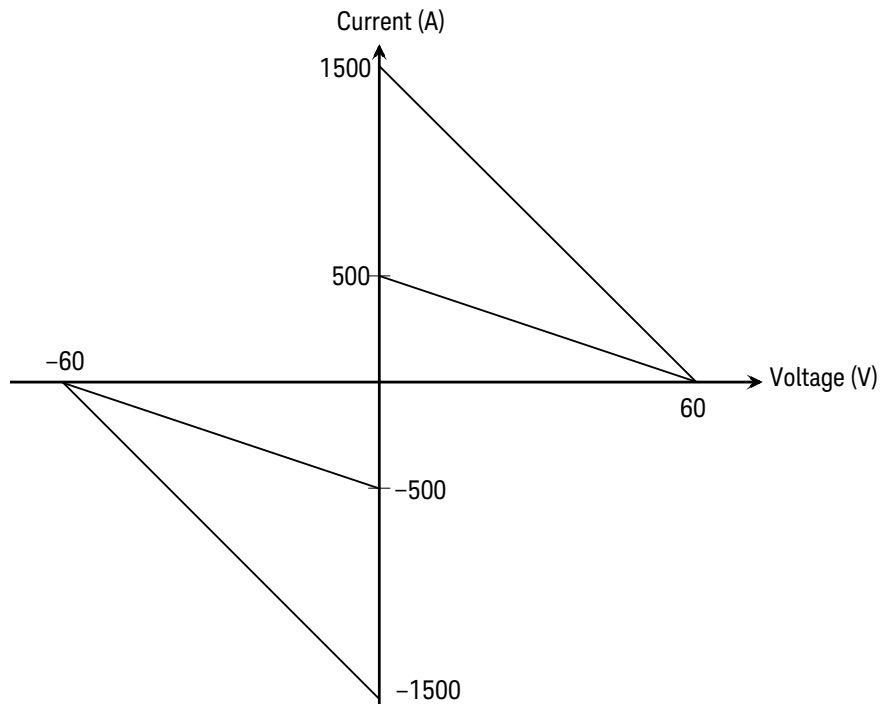

**Table 2-19 UHCU Voltage Ranges and Resolutions**

Range	Output Value	Measurement Value	Setting Resolution	Measurement Resolution	Maximum Current
100 V	$0 \leq  V  \leq 60 \text{ V}^a$	$0 \leq  V  \leq 60 \text{ V}$	200 $\mu\text{V}$	100 $\mu\text{V}$	$\pm 500 \text{ A}$ , $\pm 1500 \text{ A}^b$

a. Pulse base value is always 0 V.

b. Only for the N1265A-015.

**Table 2-20 UHCU Current Ranges and Resolutions**

Range	Output Value	Measurement Value	Setting Resolution	Measurement Resolution	Maximum Voltage
500 A	$0 \leq  I  \leq 500 \text{ A}^a$	$0 \leq  I  \leq 500 \text{ A}$	1 mA	500 $\mu\text{A}$	$\pm 63 \text{ V}^b$
2000 A <sup>c</sup>	$0 \leq  I  \leq 1500 \text{ A}$	$0 \leq  I  \leq 1500 \text{ A}$	4 mA	2 mA	

a. Pulse base value is always 0 A.

b. This is the maximum voltage compliance value.

c. Only for the N1265A-015. Pulse base value is always 0 A.

## UHVU - Ultra High Voltage Unit

The ultra high voltage unit (UHVU) is configured by the Keysight N1268A ultra high voltage expander and two MCSMU modules or a combination of a MCSMU and a HCSMU. Typical specifications of the UHVU are shown below.

- Output: DC voltage or voltage pulse
- Measurement: current or voltage
- Maximum voltage/current: 10 kV/10 mA, -10 kV/-10 mA, 10 kV/20 mA, or -10 kV/-20 mA  
Pulse width must be 1 ms or less for the current over  $\pm 10$  mA.
- Minimum pulse width: 100  $\mu$ s
- Minimum pulse period: 10 ms
- Output/measurement value and resolution: see [Table 2-21](#) and [Table 2-22](#).

Figure 2-10

### UHVU Output and Measurement Ranges

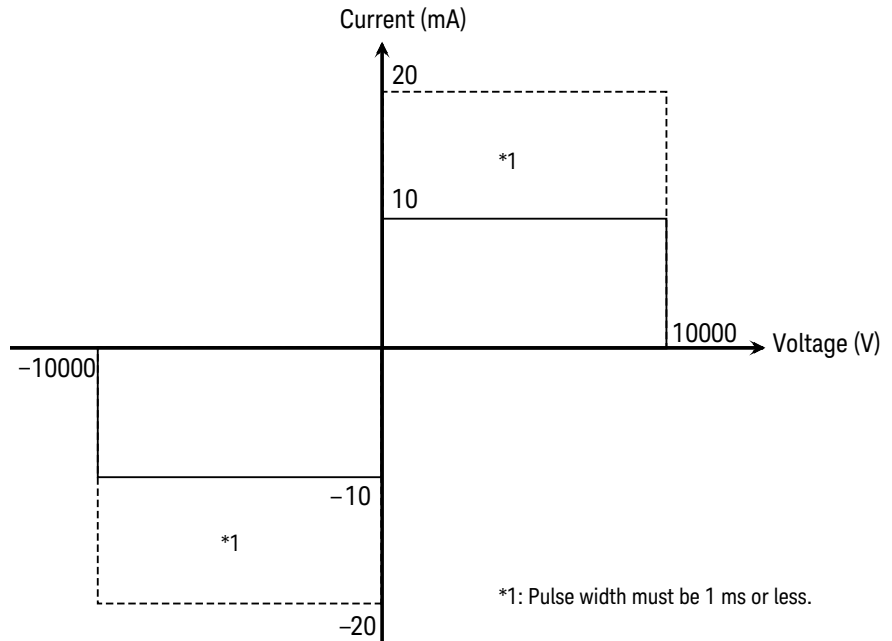

**Table 2-21 UHVU Voltage Ranges and Resolutions**

Range	Output Value	Measurement Value	Setting Resolution	Measurement Resolution	Maximum Current
10 kV	$0 \leq  V  \leq 10 \text{ kV}^a$	$0 \leq  V  \leq 10 \text{ kV}$	10 mV	10 mV	$\pm 10 \text{ mA}$ , $\pm 20 \text{ mA}^b$

a. Pulse base and peak values must be the same polarity.

b. Only for the pulse of maximum 1 ms pulse width.

**Table 2-22 UHVU Current Ranges and Resolutions**

Range	Output Value	Measurement Value	Setting Resolution	Measurement Resolution	Maximum Voltage
10 $\mu\text{A}$	—	$0 \leq  I  \leq 11.5 \mu\text{A}$	—	10 pA	$\pm 10 \text{ kV}$
100 $\mu\text{A}$	—	$0 \leq  I  \leq 115 \mu\text{A}$	—	100 pA	
1 mA	—	$0 \leq  I  \leq 1.15 \text{ mA}$	—	1 nA	
10 mA	—	$0 \leq  I  \leq 10 \text{ mA}$ , $0 \leq  I  \leq 11.5 \text{ mA}^a$	—	10 nA	
100 mA <sup>a</sup>	—	$0 \leq  I  \leq 20 \text{ mA}$	—	100 nA	

a. Only for the pulse of maximum 1 ms pulse width.

---

**CAUTION**

---

Never connect the UHVU High terminal to any output, including circuit common, chassis ground, or any other measurement resource such as SMU. Connecting other measurement resource may damage the connected one.

---

**CAUTION**

---

Never connect the UHVU Low terminal to any other measurement resource except for the N1269A or N1265A-040 adapter. Connecting other measurement resource may damage the connected one.

## MFCMU - Multi Frequency CMU

This section describes typical specification of the multi frequency capacitance measurement unit (CMU). The CMU performs the impedance measurement and returns the specified measurement data such as Cp-G. Only one module can be installed in one mainframe.

- Measurement parameters: See [Table 2-23](#).
- AC signal, output frequency:  
1 kHz to 5 MHz  
Setting resolution: 1 mHz (1 kHz to), 10 mHz (10 kHz to), 0.1 Hz (100 kHz to), or 1 Hz (1 MHz to 5 MHz)
- AC signal, output level:  
10 mVrms to 250 mVrms, 1 mV resolution
- DC bias:  
0 to ± 25 V, using MFCMU internal DC bias  
0 to ± 3000 V, using HVSMU and high voltage bias-tee
- Measurement range:  
For the fixed ranging mode, measurement range (impedance range) must be specified to perform measurement. [Table 2-24](#) shows the available measurement ranges and the corresponding impedance value. And [Figure 2-11](#) shows the calculation example of the impedance vs frequency characteristics of a capacitive load. Use these information to decide the measurement range.

Impedance  $Z$  is calculated by the following formula.

$$Z = 1 / (2\pi f C)$$

where  $f$  is frequency (Hz) and  $C$  is capacitance (F).

**Table 2-23**

**Measurement Parameters**

<b>Primary Parameter</b>	<b>Secondary Parameter</b>
R (resistance, $\Omega$ )	X (reactance, $\Omega$ )
G (conductance, S)	B (susceptance, S)
Z (impedance, $\Omega$ )	$\theta$ (phase, radian)
Z (impedance, $\Omega$ )	$\theta$ (phase, degree)
Y (admittance, S)	$\theta$ (phase, radian)
Y (admittance, S)	$\theta$ (phase, degree)
Cp (parallel capacitance, F)	G (conductance, S)
Cp (parallel capacitance, F)	D (dissipation factor)
Cp (parallel capacitance, F)	Q (quality factor)
Cp (parallel capacitance, F)	Rp (parallel resistance, $\Omega$ )
Cs (series capacitance, F)	Rs (series resistance, $\Omega$ )
Cs (series capacitance, F)	D (dissipation factor)
Cs (series capacitance, F)	Q (quality factor)
Lp (parallel inductance, H)	G (conductance, S)
Lp (parallel inductance, H)	D (dissipation factor)
Lp (parallel inductance, H)	Q (quality factor)
Lp (parallel inductance, H)	Rp (parallel resistance, $\Omega$ )
Ls (series inductance, H)	Rs (series resistance, $\Omega$ )
Ls (series inductance, H)	D (dissipation factor)
Ls (series inductance, H)	Q (quality factor)

**Table 2-24 Measurement Range for Fixed Ranging Mode**

Impedance Z	Measurement range (impedance range)		
	1 kHz ≤ f ≤ 200 kHz	200 kHz < f ≤ 2 MHz	2 MHz < f ≤ 5 MHz
0 ≤ Z < 100 Ω	50 Ω	50 Ω	50 Ω
100 Ω ≤ Z < 300 Ω	100 Ω	100 Ω	100 Ω
300 Ω ≤ Z < 1 kΩ	300 Ω	300 Ω	300 Ω
1 kΩ ≤ Z < 3 kΩ	1 kΩ	1 kΩ	1 kΩ
3 kΩ ≤ Z < 10 kΩ	3 kΩ	3 kΩ	3 kΩ
10 kΩ ≤ Z < 30 kΩ	10 kΩ	10 kΩ	
30 kΩ ≤ Z < 100 kΩ	30 kΩ	30 kΩ	
100 kΩ ≤ Z < 300 kΩ	100 kΩ		
300 kΩ ≤ Z	300 kΩ		

**Figure 2-11 Impedance vs Frequency Characteristics of Capacitive Load, Calculation Example**

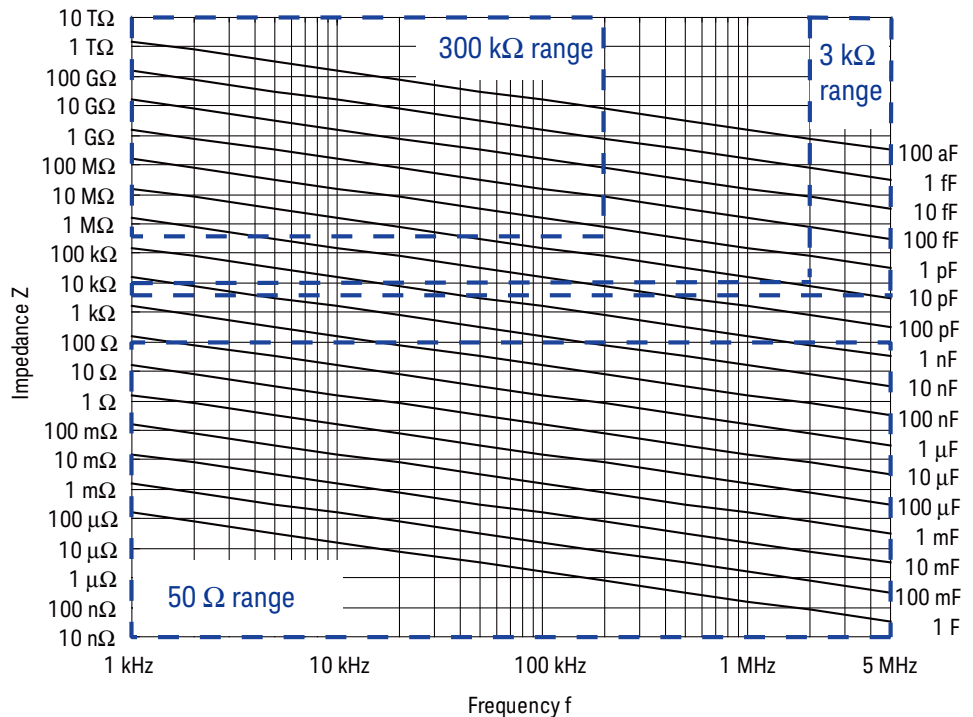

Introduction  
Measurement Resources



---

**3**

## **Accessories**

This chapter explains the following accessories available for Keysight B1505A.

- “N1258A Module Selector”
- “N1259A Test Fixture”
- “N1260A High Voltage Bias-Tee”
- “N1261A Protection Adapter”
- “N1262A Resistor Box”
- “16493S-010/011 HCSMU Adapter”
- “16493S-020/021 Dual HCSMU Adapter”
- “N1265A Ultra High Current Expander/Fixture”
- “N1266A HVSMU Current Expander”
- “N1267A HVSMU/HCSMU Fast Switch”
- “N1268A Ultra High Voltage Expander”
- “N1271A Thermal Test Enclosure”
- “N1272A Device Capacitance Selector”
- “N1273A Capacitance Test Fixture”
- “N1274A On-Wafer Gate Charge Measurement Adapter/Selector for 20 A/3 kV”
- “N1275A On-Wafer Gate Charge Measurement Adapter for N1265A”

---

**WARNING**

To avoid electrical shock and instrument damage, turn the all instruments off before connecting or disconnecting measurement cable.

Pour éviter une décharge électrique et un risque d'endommagement de l'appareil, mettez tous les appareils hors tension avant de brancher ou de débrancher le câble de mesure.

---

---

**WARNING**

The B1505A, the N1265A ultra high current expander/fixture, and the N1268A ultra high voltage expander are heavy and require a two person lift.

Le B1505A, le N1265A ultra high current expander/fixture et le N1268A ultra high voltage expander sont lourds et nécessitent deux personnes pour les soulever.

---

---

**CAUTION**

Do not grab the fixture cover when lifting the N1259A or N1265A test fixture.

---

---

**NOTE****Using Universal resistor box and Universal Socket Module**

The universal resistor box and the universal socket module are the do-it-yourself kit for installing a resistor you want or mounting a socket you want.

You need to prepare the hexlobe (torx type) screwdriver T-10 to remove the cover.

---

---

**WARNING**

After installing a resistor or mounting a socket, reattach the cover. Do not use the universal resistor box and the universal socket module under the condition that the cover is removed.

Après avoir installé une résistance ou monté une prise, remettez le couvercle en place. Ne pas utiliser la boîte de résistance universelle ni le module de prise universelle lorsque le couvercle est retiré.

---

## N1258A Module Selector

Module selector is used to switch the measurement resource connected to the device under test (DUT) automatically. The measurement resource will be GNDU, HPSMU/MPSMU, HCSMU/DHCSMU (Dual HCSMU), or HVSMU/HVMCU. One selector provides one switching channel. Also the selector installs the GNDU protection adapter and the HPSMU protection adapter. The N1258A is used with a DUT interface such as your own test fixture and prober station, not the N1259A/N1265A.

### Front Panel

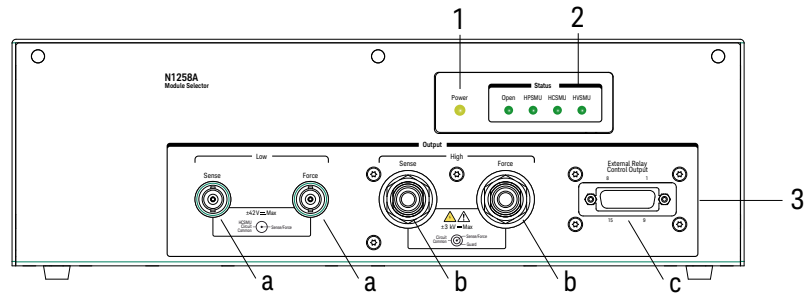

#### 1. Power indicator

This LED turns yellow when the AC power is applied to the module selector.

This LED turns green when the module selector is ready to use.

#### 2. Status indicator

A green LED lights to indicate the present connection path of the module selector.

See [Figure 3-2](#) and [Table 3-1](#) for the status indicator and the connection path.

#### 3. Output

##### a. Low Force and Sense output connectors

BNC connectors. Force and Sense must be extended to and connected together at a low terminal of a device under test (DUT). Then use high current cable with BNC(m) connector for Force, normal cable with BNC(m) connector for Sense, manipulators, and such.



##### b. High Force and Sense output connectors

HV(jack) connectors. Force and Sense must be extended to and connected together at a high terminal of the DUT.

Then use high current and high voltage cable with HV(plug) connector for Force, high voltage cable with HV(plug) connector for Sense, manipulators, and such.

Guard must be opened but should be extended as close as possible to the device terminal for reducing the leakage current of the extension cable.

c. External Relay Control Output connector

D-sub 15 pin connector. See **Figure 3-1** for pin assignment. Relay control 1 to 6 are used to control an external relay and controlled by using the FLEX command. See *Keysight B1500 Programming Guide* for the FLEX command.

Relay control signal level: 0 V or 12 V, normally 0 V (circuit common)

**Figure 3-1 External Relay Control Output Connector**

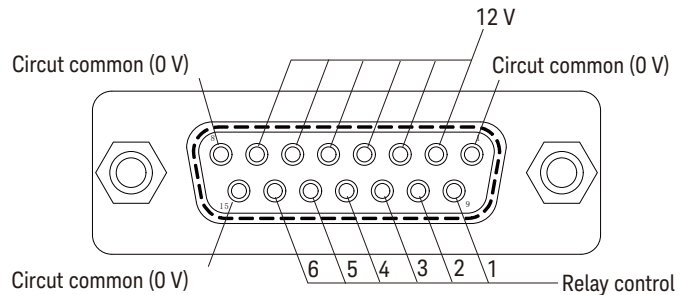
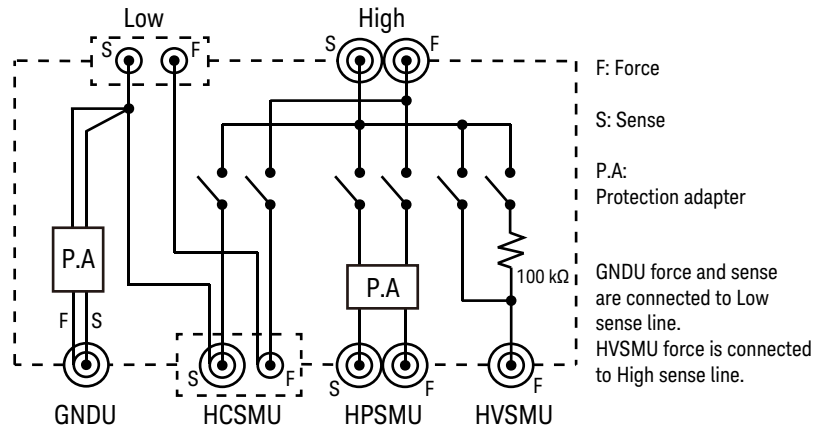

**Table 3-1 N1258A Status Indicator and Connection Path**

Status indicator	N1258A output connectors			
	Low Sense	Low Force	High Sense	High Force
Open	HCSMU Low Sense + GNDU Force + GNDU Sense	HCSMU Low Force	Open	Open
HPSMU			HPSMU Sense	HPSMU Force
HCSMU			HCSMU High Sense	HCSMU High Force
HVSMU			HVSMU Force	Open
	HVSMU Force + Series resistor			

Figure 3-2

Module Selector Simplified Internal Connections



Rear Panel

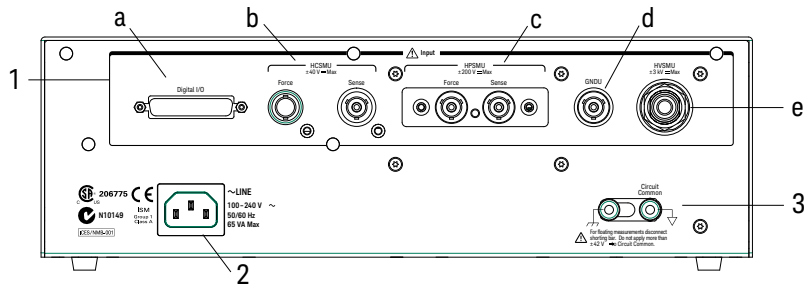

1. Input

**WARNING**



The connector cap must be connected to the unused input connectors for safety.

Le capuchon du connecteur doit être raccordé aux connecteurs d'entrée inutilisés.

**NOTE**

Do not put any conductor on the HCSMU Low Force and Low Sense terminals, outer conductor of the coaxial connectors. Putting conductor of circuit common, chassis ground, or any potential on causes the measurement error.

a. Digital I/O connector

For connecting 16493G cable from the Digital I/O connector of B1505A or N1266A expander.

b. HCSMU input connectors

Force BNC connector and Sense triaxial connector. For connecting 16493S HCSMU cable or 16493S-021 Dual HCSMU combination adapter from the HCSMU. Maximum current must be  $\pm 30$  A to prevent the module selector from performance degradation and failure.

c. HPSMU input connectors

Force and Sense triaxial connectors. For connecting 16493K Kelvin triaxial cable or 16494A triaxial cable from the HP/MPSMU.

d. GNDU input connector



GNDU triaxial connector. For connecting 16493L GNDU cable from the GNDU or the HVMCU Low.

e. HVSMU input connector

HV(jack) connector. For connecting 16493T HVSMU cable from the HVSMU or the HVMCU High.

2. LINE input receptacle

AC power cable is connected to this receptacle.

 3. Circuit Common () and frame ground () terminals

Normally, connect the terminals together by using the shorting bar.

Removing the shorting bar may be effective for reducing external noise caused by the ground loop. Then do not break the connection between the B1505A's Circuit Common and the prober station's frame ground.

---

**WARNING**



**If the Circuit Common terminal is *not* connected to the frame ground terminal (for floating measurement), a potential shock hazard may present. Do not touch any of measurement circuit at any time while a floating measurement is in progress.**

**Si la borne Circuit Common *n'est pas* connectée à la borne de terre du cadre (pour des mesures de flotte), il peut y avoir un risque de choc électrique. Ne touchez aucun circuit de mesure à n'importe quel moment quand la mesure de flotte est en cours.**

---

---

**CAUTION**

---

For floating measurement, do not apply dangerous voltage to the Circuit Common terminal. Failure to heed this caution may result in damage to the N1258A.

---

**NOTE**

---

Module selector may emit a noise sound during operation. However it is not abnormal status.



## N1259A Test Fixture

The N1259A is used for measurements of packaged devices. The N1259A can be connected to GNDU, MFCMU, HPSMU/MPSMU, HVSMU/HVMCU, and HCSMU/MCSMU/DHCSMU (Dual HCSMU). And the fixture initially installs the GNDU protection adapter and the HPSMU protection adapter. Also the fixture can install the module selector for switching the measurement resource connected to the DUT, the high voltage resistor box for reducing the risk of device breakdown, and the high voltage bias-tee for performing the high voltage capacitance measurement.

### Front Panel

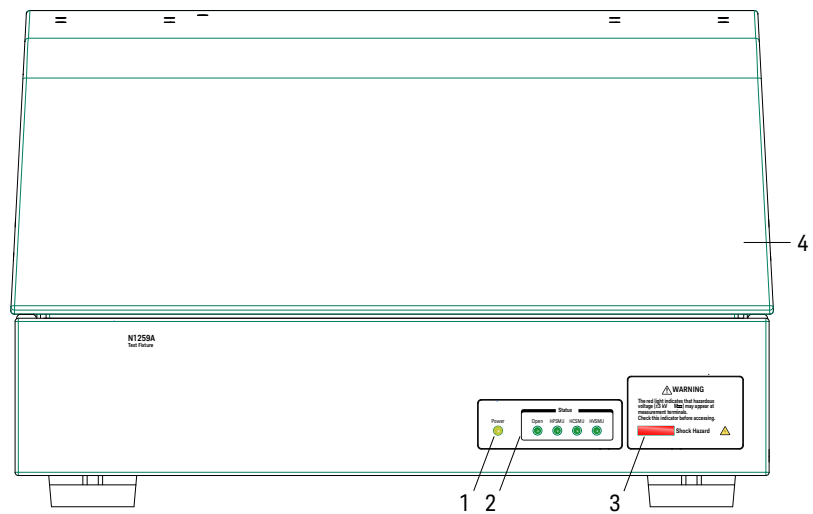

1. Power indicator (N1259A-300)

This LED turns yellow when the AC power is applied to the test fixture.

This LED turns green when the test fixture is ready to use.

2. Status indicator (N1259A-300)

A green LED lights to indicate the present connection path of the module selector. See [Figure 3-2](#) and [Table 3-2](#) for the status indicator and the connection path.

 3. Hazardous voltage status indicator

This red LED lights when a source channel applies dangerous voltage. This indicator is connected to the B1505A via the Interlock connector and works with the High Voltage indicator on the B1505A's front panel.

Warning labels written in French, German, and Japanese are furnished. Attach the label to the front panel of the fixture if you need.

---

**WARNING**



**The red light indicates that hazardous voltage (maximum  $\pm 3000$  Vdc) may appear at measurement terminals. Check this indicator before accessing.**

**Le témoin rouge indique qu'une tension dangereuse (maximum  $\pm 3000$  V CC) risque d'apparaître au niveau des bornes de mesure. Vérifiez cet indicateur avant d'accéder.**

---

4. Fixture cover

The fixture cover should be closed to avoid electrical shock by touching measurement terminals and to prevent a device under test from external noise.

When the fixture cover is open, maximum SMU output is limited to  $\pm 42$  V.

---

**WARNING**



**Hazardous voltage, instrument maximum output voltage may appear at the Force, Guard, and Sense terminals if the fixture cover is closed.**

**Une tension dangereuse, une tension de sortie maximale de l'appareil peut apparaître aux bornes Force, Guard et Sense si le couvercle de l'équipement est fermé.**

---

**WARNING**



**Make sure that the cover is closed properly before starting measurement. Do not perform the measurement when a wire is protruding from the fixture cover.**

**Assurez-vous que le couvercle est fermé correctement avant de commencer la mesure. Ne pas effectuer la mesure lorsqu'un câble dépasse du couvercle de l'appareil.**

---

## Rear Panel

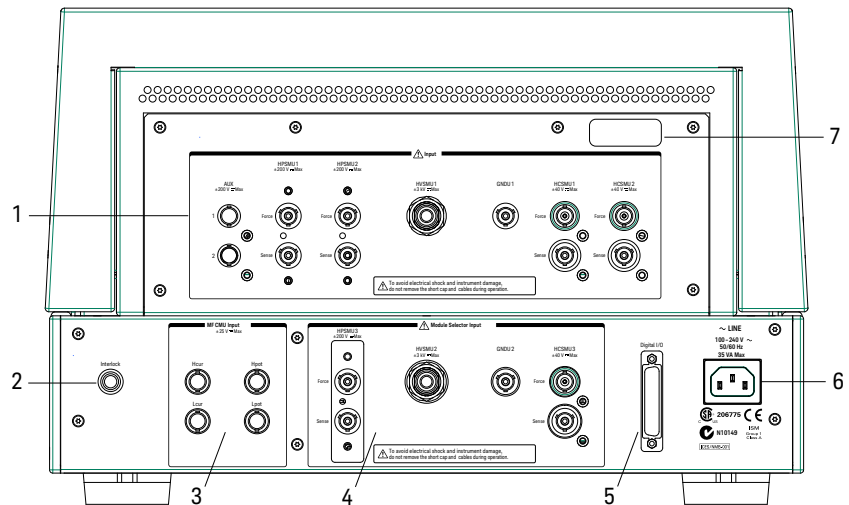

### WARNING



The connector cap must be connected to the unused input connectors for safety.

Le capuchon du connecteur doit être raccordé aux connecteurs d'entrée inutilisés.



#### 1. Input

- AUX1 and AUX2 input connectors  
BNC connectors. For connecting MFCMU or external instruments.
- HPSMU1 and HPSMU2 input connectors  
Force and Sense triaxial connectors. For connecting 16493K Kelvin triaxial cable or 16494A triaxial cable from the HP/MPSMU.
- HVSMU1 input connector  
HV(jack) connector. For connecting 16493T HVSMU cable from the HVSMU or the HVMCU High.
- GNDU1 input connector  
GNDU triaxial connector. For connecting 16493L GNDU cable from the GNDU or the HVMCU Low.

- HCSMU1 and HCSMU2 input connectors

Force BNC connector and Sense triaxial connector. For connecting 16493S HCSMU cable or 16493S-021 Dual HCSMU combination adapter from the HCSMU. MCSMU can be used. Then use 16494A triaxial cables and N1254A-104 adapter.

2. Interlock connector

Interlock connector. For connecting 16493J interlock cable from B1505A.

3. MF CMU Input connectors Hcur, Hpot, Lpot, and Lcur (N1259A-020)

BNC connectors. For connecting N1300A cable from the MFCMU.



4. Module Selector Input (N1259A-300)

- HPSMU3 input connectors

Force and Sense triaxial connectors. For connecting 16493K Kelvin triaxial cable or 16494A triaxial cable from the HP/MPSMU.

- HVSMU2 input connector

HV(jack) connector. For connecting 16493T HVSMU cable from the HVSMU or the HVMCU High.

- GNDU2 input connector

GNDU triaxial connector. For connecting 16493L GNDU cable from the GNDU or the HVMCU Low.

- HCSMU3 input connectors

Force BNC connector and Sense triaxial connector. For connecting 16493S HCSMU cable or 16493S-021 Dual HCSMU combination adapter from the HCSMU. Maximum current must be  $\pm 30$  A to prevent the module selector from performance degradation and failure.

---

**NOTE**

---

Do not put any conductor on the HCSMU Low Force and Low Sense terminals, outer conductor of the coaxial connectors. Putting conductor of circuit common, chassis ground, or any potential on causes the measurement error.

5. Digital I/O connector (N1259A-300)

For connecting 16493G cable from the Digital I/O connector of B1505A or N1266A expander.

6. LINE input receptacle (N1259A-300)

AC power cable is connected to this receptacle.

## 7. Serial number

You need this *serial number* when using Keysight Technologies telephone assistance program.

**Table 3-2 N1259A Status Indicator and Module Selector Connection Path**

Status indicator	Module Selector Output terminals			
	Low Sense	Low Force	High Sense	High Force
Open	HCSMU3 Low Sense + GNDU2 Force + GNDU2 Sense	HCSMU3 Low Force	Open	Open
HPSMU			HPSMU3 Sense	HPSMU3 Force
HCSMU			HCSMU3 High Sense	HCSMU3 High Force
HVSMU			HVSMU2 Force	Open
			HVSMU2 Force + Series resistor	

## Output Terminal Panel

### WARNING



Set the instrument output off before connecting or disconnecting connection wire.

Press the B1505A front panel Stop key to set the output off. And confirm that the B1505A front panel High Voltage indicator is not lit.

Désactivez la sortie de l'appareil avant de brancher ou de débrancher un câble de connexion.

Appuyez sur la touche Stop du panneau avant du B1505A pour désactiver la sortie. Et confirmez que l'indicateur de tension High du panneau avant du B1505A n'est pas allumé.

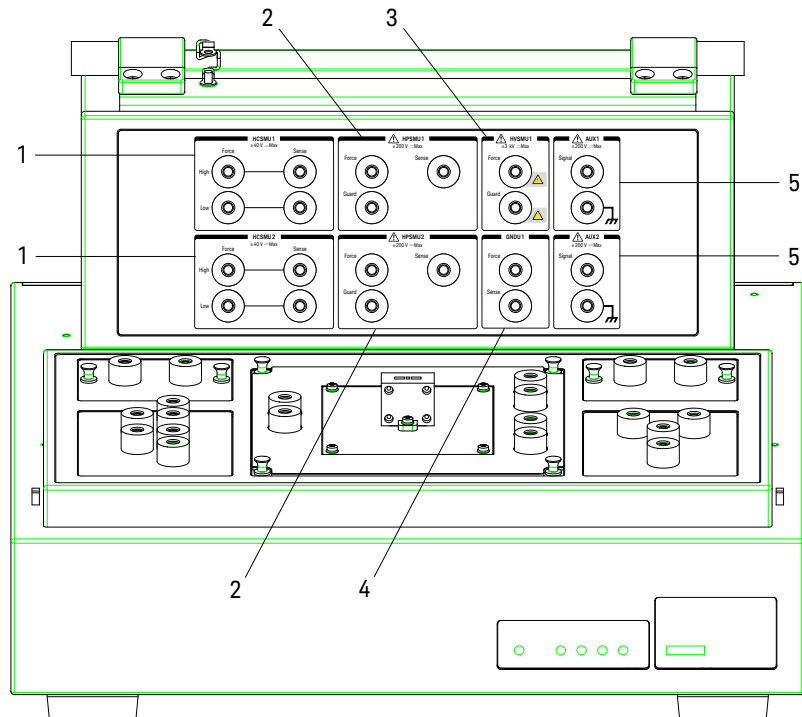

#### 1. HCSMU1 and HCSMU2

Output terminals internally connected to the HCSMU1 and HCSMU2 input connectors. High Force and Sense terminals and Low Force and Sense terminals for each HC/MC/DHCSMU.

High Force and Sense must be connected to the high terminal of a device under test (DUT).

Low Force and GNDU Force must be connected to the same terminal, and Low Sense and GNDU Sense must be connected to the same terminal. And they must be connected to the low terminal of the DUT.

 2. HPSMU1 and HPSMU2

Output terminals internally connected to the HPSMU1 and HPSMU2 input connectors. Force, Sense, and Guard terminals for each HP/MPSMU.

Force must be connected to a terminal of a DUT. And Guard must be opened. You may extend it as close as possible to the DUT terminal for reducing the leakage current of the extension cable. Also Force and Sense should be connected together at the device end for making the Kelvin connection effective for low resistance and high current measurements.

 3. HVSMU1

Output terminals internally connected to the HVSMU1 input connector. Force and Guard terminals for HVSMU/HVMCU High.

Force must be connected to a terminal of a DUT. And Guard must be opened. You may extend it as close as possible to the DUT terminal for reducing the leakage current of the extension cable.

---

**CAUTION**

---

Never connect the HVSMU1 Force and Guard terminals to any output, including circuit common, chassis ground, or any other measurement resource such as SMU. Connecting other measurement resource may damage the connected one.

4. GNDU1

Output terminals internally connected to the GNDU1 input connector. Force and Sense terminals for GNDU or HVMCU Low. Force and Sense must be connected together at the device end.

For using the HCSMU, the GNDU1 Force and Sense terminals and the HCSMU1 or HCSMU2 Low Force and Sense terminals must be connected together at the device end.

 5. AUX1 and AUX2

Output terminals internally connected to the AUX1 and AUX2 input connectors. Signal and frame ground terminals for each AUX. Signal must be connected to a terminal of a DUT.

Frame ground may be connected to the ground terminal of the DUT.

## Socket Panel

---

**WARNING**

**Set the instrument output off before connecting or disconnecting connection wire.**

**Press the B1505A front panel Stop key to set the output off. And confirm that the B1505A front panel High Voltage indicator is not lit.**

**Désactivez la sortie de l'appareil avant de brancher ou de débrancher un câble de connexion.**

**Appuyez sur la touche Stop du panneau avant du B1505A pour désactiver la sortie. Et confirmez que l'indicateur de tension High du panneau avant du B1505A n'est pas allumé.**

---

**WARNING**

**To prevent electrical shock and DUT damage, do not connect or disconnect the DUT while the instrument is applying voltage or current.**

**When you touch the DUT after measurement, devise a countermeasure of residual charge and heat to prevent electrical shock and burn. Use gloves and any tool. Also have enough time for discharge and radiation.**

**Afin d'éviter toute décharge électrique et dommage MST, ne branchez ou débranchez pas la sortie MST alors que l'appareil envoie de la tension ou du courant.**

**Lorsque vous touchez le MST après la mesure, élaborer une contre-mesure de la charge résiduelle et du chauffage afin d'éviter tout choc électrique et toute brûlure. Utilisez des gants et des outils. Prévoyez également du temps pour la décharge et la radiation.**

---



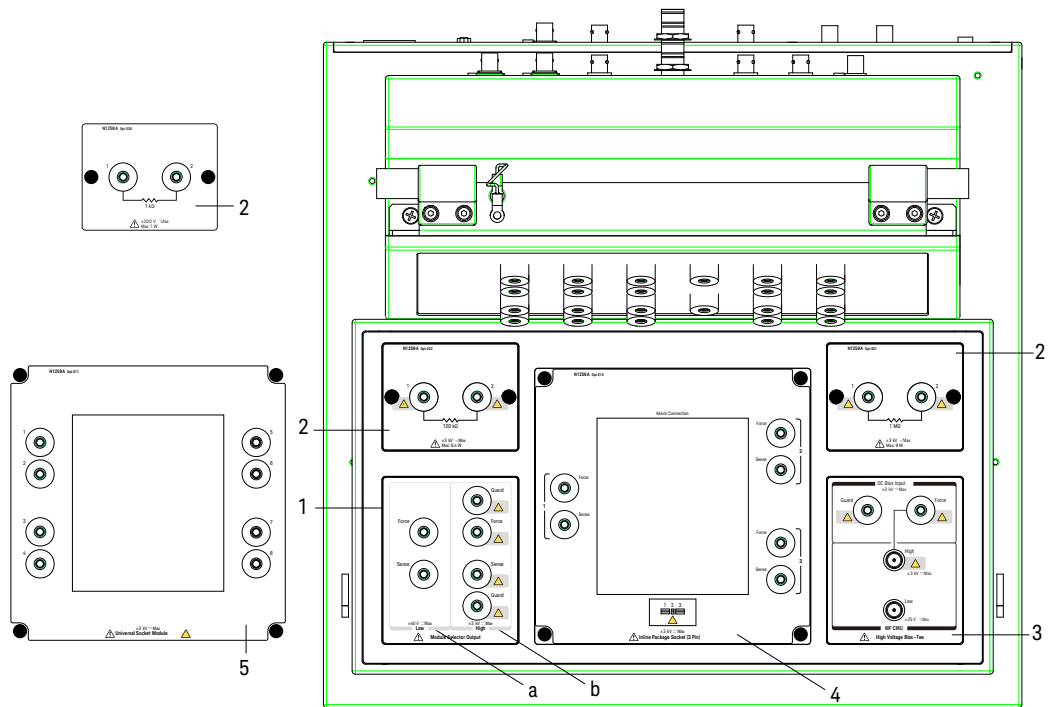

 1. Module Selector Output (N1259A-300)

See [Figure 3-2](#) and [Table 3-2](#) for the status indicator and the connection path.

a. Low Force and Sense output terminals

Force and Sense must be connected together at the low terminal of a DUT.

b. High Force, Sense, and Guard output terminals

Force and Sense must be connected together at the high terminal of a DUT. And Guard must be opened. You may extend it as close as possible to the DUT terminal for reducing the leakage current of the extension cable.

**NOTE**

Module selector may emit a noise sound during operation. However it is not abnormal status.

 2. Resistor box

For reducing damage of DUT or preventing SMU from oscillation. The following resistors are available by the options.

1 M $\Omega$  resistor box (N1259A-021) for the drain/collector terminal

100 k $\Omega$  resistor box (N1259A-022) for the drain/collector terminal

1 k $\Omega$  resistor box (N1259A-030) for the gate/base terminal

The resistor is internally connected between the terminals 1 and 2. Connect the resistor between a source output terminal and a terminal of the DUT.

Universal resistor box (N1259A-035) is also available which is kind of a do-it-yourself kit for installing a resistor. You can install your desired resistor to this box.

 3. High Voltage Bias-Tee (N1259A-020)

MF CMU High and Low terminals are internally connected to the MF CMU Input connectors. High and Low must be connected to the high and low terminals of a DUT respectively. Use SHV(plug)-SHV(plug) cable (N1254A-512) and SHV(jack)-banana adapter (N1254A-513) for connection.

To get DC bias, connect the DC Bias Input Force and Guard terminals to the Force and Guard terminals of HVSMU, HPSMU, or MPSMU. Use connection wire (N1254A-508 or 509) for connection.

---

**NOTE**

---

SMU is used for the DC bias source. MFCMU built-in DC bias source cannot be used.

 4. Inline Package Socket Module (N1259A-010)

This module provides a socket used for connecting three-terminal inline packaged device and three couples of the Force and Sense terminals. Socket module internal connection is shown in [Figure 3-3](#).

Short bar is furnished with the module. It is used for performing the short correction before the impedance measurement. Set the short bar before the short correction and remove it after the correction.

To use this module, see the following simple instruction.

- a. Attach the socket module to the test fixture.
- b. Connect wires (N1254A-508 or 509) between the socket module terminals and the fixture output terminals.

For making the Kelvin connection, Force and Sense must be connected to Force and Sense of the socket module respectively.

If MCSMU, HCSMU, or DHCSMU is used, High Force and Sense must be connected to Force and Sense used for the high terminal of a device under test (DUT), respectively. Low Force and GNDU Force must be connected to Force used for the low terminal of the DUT, and Low Sense and GNDU Sense must be connected to Sense used for the low terminal of the DUT.

- c. Set the DUT on the socket.
- d. Close the fixture cover and perform measurement.

---

**CAUTION**

---

Do not apply voltage/current over the maximum limit of the socket module.

**Figure 3-3**      **Inline Package Socket Module**

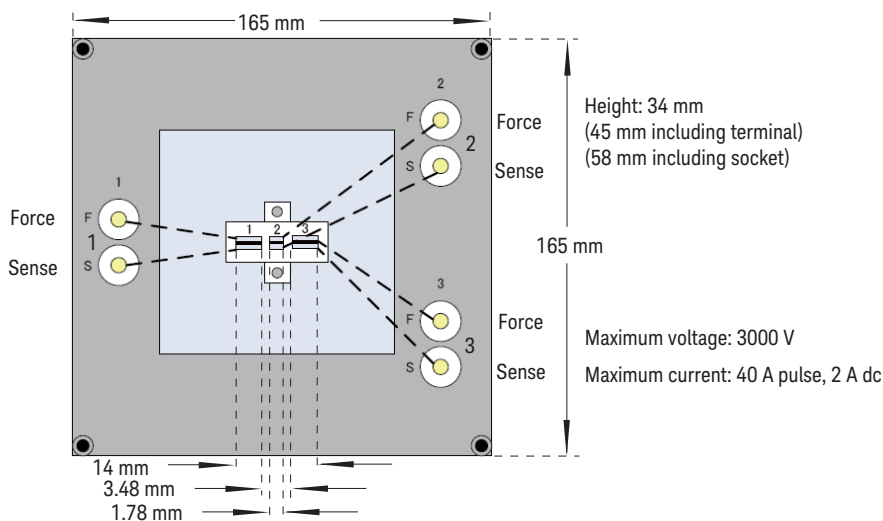

**⚠ 5. Universal Socket Module (N1259A-011)**

This is a blank module, kind of a do-it-yourself kit for supporting variety of packaged devices. This module can be used by mounting your desired socket or packaged device and making connections same as the N1259A-010 Inline Package Socket Module.

To use this module, see the following simple instruction. For the component locations and dimensions, see [Figure 3-4](#). Also see [“Inline Package Socket Module \(N1259A-010\)” on page 3-18](#) to perform measurement.

**Figure 3-4 Universal Socket Module**

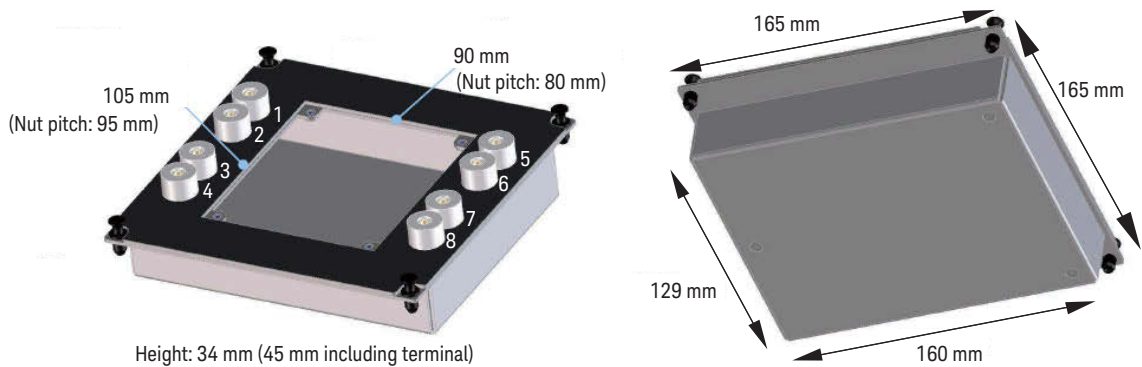

- a. Prepare the following parts.
  - blank board suitable for mounting the socket or packaged device
  - screw M3, 4 ea., for fixing the blank board on the socket module
  - wire, adequate length and quantity, for making connections
  - hexlobe (torx type) screwdriver T-10
  - socket, if you use, and packaged device under test (DUT)
- b. Cut the blank board in 104 mm × 89 mm square.
- c. Make four screw holes on the board. The holes should be 4.5 mm inside from the edge.
- d. Fix the board to the blank module.
- e. Remove the cover bottom of the blank module.
- f. Mount the socket or DUT on the board and solder wire between its terminals and the blank module terminals 1 to 8.

**WARNING**



**Make enough space between the socket/DUT terminal and the shield/chassis, for example, about 1 mm for maximum 200 V output and 6 mm for 3000 V, to prevent discharge and any accident.**

**Laissez suffisamment d'espace entre la prise/la borne MST et la protection/le châssis. Par exemple, environ 1 mm pour une sortie de 200 V au maximum et 6 mm pour 3 000 V afin d'éviter toute décharge et tout accident.**

- g. Reattach the cover.

6. Blank PTFE Board (N1259A-012)

This is an insulation board used for placing a DUT.

To use this board, see the following simple instruction.

**Figure 3-5**

**Blank PTFE Board**

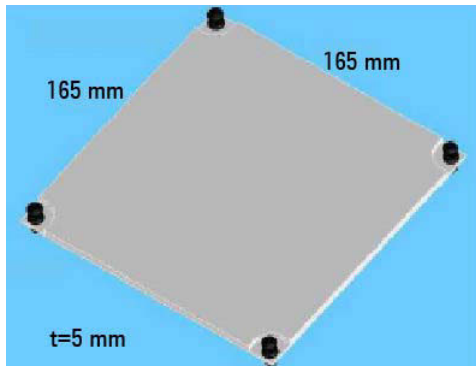

- Prepare a DUT, wire (N1254A-508 or 509), and dolphin clip adapter (N1254A-510) or cable lug adapter (N1254A-511).
- Attach the blank PTFE board to the test fixture.
- Connect adapters directly to the DUT and put it on the blank PTFE board.
- Connect wires between the adapters and the fixture output terminals.

For making the Kelvin connection, Force and Sense must be connected together at the device terminal.

If MCSMU, HCSMU, or DHCSMU is used, High Force and Sense must be connected to the high terminal of a device under test (DUT). Low Force, Low Sense, GNDU Force, and GNDU Sense must be connected to the low terminal of the DUT.

- Make sure the DUT location. The DUT must be placed on the blank PTFE board properly.

---

**WARNING**

**Make enough space between the High-Low adapters, also between the high side adapter and the shield/chassis, for example, about 1 mm for maximum 200 V output and 6 mm for 3000 V, to prevent discharge and any accident.**

**Laissez suffisamment d'espace entre les adaptateurs High-Low et également entre l'adaptateur du côté élevé et la protection/le châssis. Par exemple, environ 1 mm pour une sortie de 200 V au maximum et 6 mm pour 3 000 V afin d'éviter toute décharge et tout accident.**

---

f. Close the fixture cover and perform measurement.

7. Curve Tracer Test Adapter Socket Module (N1259A-013)

This module provides a socket available for connecting a test adapter designed for connecting to Tektronix 370B/371B curve tracers. Socket module internal connection is shown in [Figure 3-6](#).

To use this module, see the following simple instruction.

- a. Attach the socket module to the test fixture.
- b. Connect your test adapter to the socket.
- c. Connect wires (N1254A-508 or 509) between the socket module terminals and the fixture output terminals.

For making the Kelvin connection, Force and Sense must be connected to Force and Sense of the socket module respectively.

If MCSMU, HCSMU, or DHCSMU is used, High Force and Sense must be connected to Force and Sense used for the high terminal of a device under test (DUT), respectively. Low Force and GNDU Force must be connected to Force used for the low terminal of the DUT, and Low Sense and GNDU Sense must be connected to Sense used for the low terminal of the DUT.

- d. Set the DUT on your test adapter.
- e. Close the fixture cover and perform measurement.

---

**CAUTION**

Do not apply voltage/current over the maximum limit of the socket module.

---

**Figure 3-6 Curve Tracer Test Adapter Socket Module**

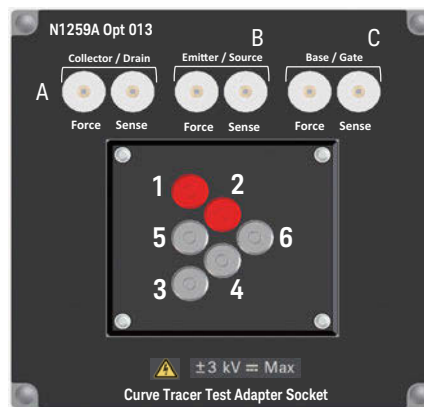

Internal connection

- 1: Collector/Drain Force
- 2: Collector/Drain Sense
- 3: Emitter/Source Force
- 4: Emitter/Source Sense
- 5: Base/Gate Force
- 6: Base/Gate Sense

Maximum voltage: 3000 V

Maximum current:

- A-Force: 500 A pulse, 39 A dc
- A-Sense: 40 A pulse, 2 A dc
- B-Force: 500 A pulse, 39 A dc
- B-Sense: 40 A pulse, 2 A dc
- C-Force: 40 A pulse, 2 A dc
- C-Sense: 40 A pulse, 2 A dc

8. Gate charge socket module (N1259A-014)

This socket adapter is designed for performing the gate charge measurement.

To use this module, see the following simple instruction.

- a. Attach the socket module to the test fixture.
- b. Connect wires between the socket module terminals and the fixture output terminals. You can use the following wires supplied with the socket module.
  - N1254A-508: long wire (red), 4 ea.
  - N1254A-509: long wire (black), 4 ea.
  - N1265-61751: short wire (red), 2 ea.
  - N1265-61752: short wire (black), 2 ea.

For making the Kelvin connection, Force and Sense must be connected together at the device terminal.

Figure 3-8 and Figure 3-9 show connection examples.

- c. Set the current control device on the left socket or connect the load resistor between the studs for the resistor.

The current control device must be an extra 3-pin inline package device which is expected to have the same characteristics as DUT. If the device is not available, use a load resistor. The resistor must satisfy the following specifications.

Resistance =  $V_r/I_r$  ( $V_r$ : rated voltage,  $I_r$ : rated current)

$$\text{Peak power} \geq V_r \times I_r \times 1 \text{ ms}$$

- d. Set your DUT on the right socket.
- e. Close the fixture cover and perform measurement.

**CAUTION**

Do not apply voltage/current over the maximum limit of the socket module.

**Figure 3-7 Gate Charge Socket Module**

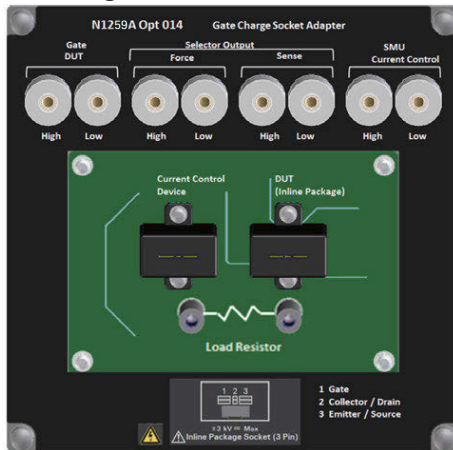

- Gate DUT
  - High: Max. 30 V / 1 A
  - Low: Max. 10 V / 1 A
- Selector Out Force
  - High: Max. 3000 V / 500 A
  - Low: Max. 10 V / 500 A
- Selector Out Sense
  - High: Max. 3000 V / 20 mA
  - Low: Max. 10 V / 20 mA
- SMU Current Control
  - High: Max. 30 V / 1A floating 3000 V
  - Low: Max. 10 V / 1A floating 3000 V

**Figure 3-8 Connection Example for High Voltage Gate Charge Measurement**

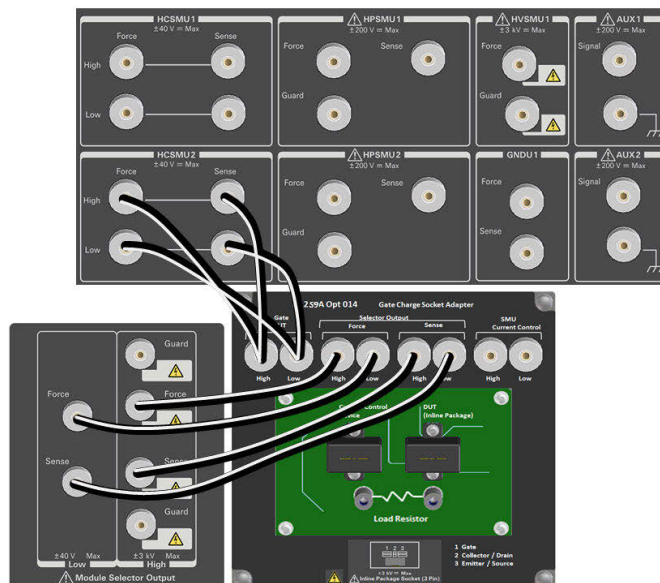



**Figure 3-9** Connection Example for High Current Gate Charge Measurement

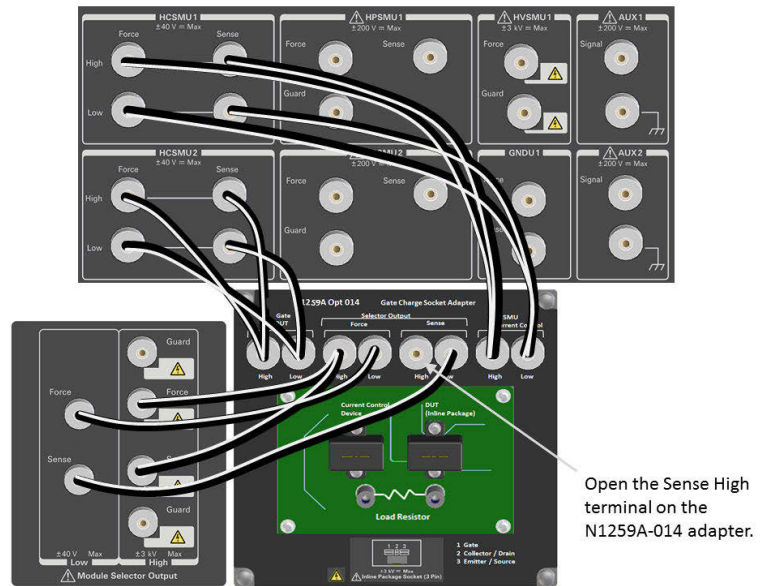

---

**NOTE**

---

For the high current gate charge measurement, connect the Selector Output Sense High terminal on the fixture to the Selector Output Force High terminal on the N1259A-014 adapter. Measurement may fail depending on the device characteristics if it is connected to the Selector Output Sense High terminal.

## N1260A High Voltage Bias-Tee

High voltage bias-tee is used to perform the high voltage C-V measurement. The C-V measurement of up to 3000 Vdc can be realized by using the bias-tee, MFCMU, and HVSMU. The N1260A is used with the N1265A test fixture or a DUT interface such as your own test fixture and prober station.

---

**NOTE**

---

HVSMU is used for the DC bias source. MFCMU built-in DC bias source cannot be used.

- From HVSMU  
HV(jack) connector. For connecting 16493T HVSMU cable from the HVSMU.
- From MFCMU Hcur, Hpot, Lpot, and Lcur  
BNC connectors. For connecting N1300A cable from the MFCMU.
- Output Low and High  
SHV(jack) connector. Low and High must be extended to the low and high terminals of a DUT respectively. Use N1254A-518 SHV cable to connect N1265A test fixture. To connect other DUT interface, use high voltage cable with SHV(plug) connector, manipulators, and such.
- AC Guard  
SHV(jack) connector. Provides the AC guard (circuit common) signal of MFCMU. For the 3-terminal device measurement, the AC Guard must be extended to the device terminal which is not connected to Low or High. For making the connection, use cable with SHV(plug) connector, manipulator, and such.  
  
To use N1265A test fixture, open this connector.

---

**CAUTION**

---

Never connect the HVSMU Force and Guard terminals to any output, including circuit common, chassis ground, or any other measurement resource such as SMU. Connecting other measurement resource may damage the connected one.

## N1261A Protection Adapter

Adapter for protecting GNDU or HP/MPSMU module from high voltage. The N1261A is used with the N1265A test fixture or a DUT interface such as your own test fixture and prober station.

N1261A-001: HPSMU protection adapter, Triaxial(f)-Triaxial(f)

N1261A-002: GNDU protection adapter, Triaxial(f)-BNC(f)

N1261A-003: HPSMU protection adapter, Triaxial(f)-HV(jack)

N1261A-004: GNDU protection adapter, Triaxial(f)-SHV(jack)

- From HPSMU of N1261A-001 and 003

Force and Sense triaxial connectors. For connecting 16493K Kelvin triaxial cable or 16494A triaxial cable from the HP/MPSMU.

- Output of N1261A-001

Triaxial connectors. Force must be extended to a terminal of a DUT. Guard must be opened but should be extended as close as possible to the device terminal for reducing the leakage current of the extension cable. Use 16494A triaxial cable to connect N1265A test fixture. To connect other DUT interface, use high voltage cable with Triaxial(m) connector, manipulators, and such.

Sense should be also extended to the DUT terminal. And Force and Sense should be connected together at the device end for making the Kelvin connection effective for low resistance and high current measurements.

- Output of N1261A-003

HV(jack) connectors. Force must be extended to a terminal of a DUT. Guard must be opened but should be extended as close as possible to the device terminal for reducing the leakage current of the extension cable. For making the connection, use high voltage cable with HV(plug) connector, manipulators, and such.

Sense should be also extended to the DUT terminal. And Force and Sense should be connected together at the device end for making the Kelvin connection effective for low resistance and high current measurements.

- From GNDU of N1261A-002 and 004

GNDU triaxial connector. For connecting 16493L GNDU cable from the GNDU.

- Output of N1261A-002  
BNC connectors. Force and Sense must be extended to a terminal of a DUT. And they must be connected together at the device end. For making the connection, use high voltage cable with BNC(m) connector, manipulators, and such.
- Output of N1261A-004  
SHV(jack) connectors. Force and Sense must be extended to a terminal of a DUT. And they must be connected together at the device end. For making the connection, use high voltage cable with SHV(plug) connector, manipulators, and such.

## **N1262A Resistor Box**

Resistor box for reducing the risk of device breakdown or preventing SMU from oscillation. 1 k $\Omega$  ( $\pm$  200 Vdc), 1 k $\Omega$  ( $\pm$  3000 Vdc), 100 k $\Omega$  ( $\pm$  3000 Vdc), or 1 M $\Omega$  ( $\pm$  3000 Vdc). The N1262A is used with a DUT interface such as your own test fixture and prober station, not the N1259A/N1265A test fixture.

N1262A-001: 1 M $\Omega$  ( $\pm$  3000 Vdc) resistor, HV(jack)-SHV(jack)

N1262A-002: 100 k $\Omega$  ( $\pm$  3000 Vdc) resistor, HV(jack)-SHV(jack)

N1262A-010: 1 k $\Omega$  ( $\pm$  200 Vdc) resistor, Triaxial(f)-Triaxial(f)

N1262A-011: 1 k $\Omega$  ( $\pm$  3000 Vdc) resistor, HV(jack)-SHV(jack)

N1262A-020: Universal resistor box, Triaxial(f)-Triaxial(f)

N1262A-021: Universal resistor box, HV(jack)-SHV(jack)

N1262A-023: Universal resistor box, UHV(jack)-UHV(jack)

N1262A-036: 50  $\Omega$  termination adapter

Universal resistor box is kind of a do-it-yourself kit for installing a resistor you want.

50  $\Omega$  termination adapter is a BNC(f)-BNC(m) adapter which contains 50  $\Omega$  resistor between signal line and shield. If a SMU is used as the gate drive for the measurement using HVMCU, UHVU, or UHCU, the SMU may cause oscillation. Then this adapter should be connected between the gate drive output and a DUT terminal. This will be effective for preventing oscillation.

- From HVSMU of N1262A-001 and 002  
HV(jack) connector. For connecting 16493T HVSMU cable from the HVSMU or HVMCU.
- From SMU of N1262A-010 and 020  
Triaxial connector. For connecting 16494A triaxial cable from the Force connector of the HP/MPSMU directly or via the N1261A-001 protection adapter.
- From SMU of N1262A-011 and 021  
HV(jack) connector. For connecting 16493T HVSMU cable from the N1261A-003 protection adapter connected to the HP/MPSMU.
- From UHV of N1262A-023  
UHV(jack) connector. For connecting UHV cable from the N1268A ultra high voltage expander.
- Output of N1262A-001, 002, 011, and 021  
SHV(jack) connector. Signal must be extended to a terminal of a DUT. For making the connection, use high voltage cable with SHV(plug) connector, manipulators, and such.
- Output of N1262A-010 and 020  
Triaxial connector. Signal must be extended to a terminal of a DUT. For making the connection, use cable with Triaxial(m) connector, manipulators, and such.
- Output of N1262A-023  
UHV(jack) connector. Signal must be extended to a terminal of a DUT. For making the connection, use ultra high voltage cable with UHV(plug) connector, manipulators, and such.

## 16493S-010/011 HCSMU Adapter

Adapters for HCSMU. The adapters are used with a DUT interface such as your own test fixture and prober station, not the N1259A/N1265A test fixture.

16493S-010: Adapter for making the Kelvin connection of HCSMU path

16493S-011: Adapter for making the non-Kelvin connection of HCSMU path

- From HCSMU  
Triaxial connector (Sense) and BNC connector (Force). For connecting 16493S HCSMU cable from the HCSMU.
- Output of 16493S-010
  - High Force/Sense  
BNC connectors. Force and Sense must be extended to and connected together at the high terminal of a DUT. For making the connection, use high voltage cable with BNC(m) connector, manipulators, and such.
  - Low Force/Sense  
BNC connectors. Force and Sense must be extended to and connected together at the low terminal of a DUT. For making the connection, use high voltage cable with BNC(m) connector, manipulators, and such.  
  
The DUT's low terminal must be also connected to Force and Sense of the GNDU. Use the N1261A-002/004 GNDU protection adapter.
- Output of 16493S-011  
BNC connectors. High Force must be extended to the high terminal of a DUT. Low Force must be extended to the low terminal of the DUT. For making the connection, use high voltage cable with BNC(m) connector, manipulators, etc.  
  
The DUT's low terminal must be also connected to Force and Sense of the GNDU. Use the N1261A-002/004 GNDU protection adapter.

---

**NOTE**

---

Do not put any conductor on the HCSMU Low Force and Low Sense terminals, outer conductor of the coaxial connectors. Putting conductor of circuit common, chassis ground, or any potential on causes the measurement error.

## 16493S-020/021 Dual HCSMU Adapter

Adapters for Dual HCSMU operation. The adapters are used to connect two HCSMU modules installed in one B1505A. Using two modules can expand the B1505A maximum current up to  $\pm 40$  A (pulse),  $\pm 2$  A (DC).

16493S-020: Dual HCSMU Kelvin combination adapter

This adapter is used with a DUT interface such as your own test fixture and prober station, not the N1259A/N1265A test fixture. The N1258A module selector cannot be used.

16493S-021: Dual HCSMU combination adapter

This adapter is used with the N1259A/N1265A test fixture, the N1258A module selector, or the 16493S-010/011 HCSMU adapter.

---

### CAUTION

---

If DHCSMU (Dual HCSMU) is used with the N1258A or N1259A-300 module selector, the maximum current must be  $\pm 30$  A to prevent the module selector from performance degradation and failure.

- Output of 16493S-020
  - High Force/Sense

HV(jack) connectors. Force and Sense must be extended to the high terminal of a DUT and they must be connected together at the device end. For making the connection, use high voltage cable with HV(plug) connector, manipulators, and such.
  - Low Force/Sense

BNC connectors. Force and Sense must be extended to the low terminal of the DUT and they must be connected together at the device end. For making the connection, use high voltage cable with BNC(m) connector, manipulators, and such.
- Output of 16493S-021

Triaxial connector (Sense) and BNC connector (Force). For connecting the dedicated cable, 30 cm, furnished, or 16493S HCSMU cable to the HCSMU input connectors of the N1259A/N1265A test fixture, the N1258A module selector, or the 16493S-010/011 HCSMU adapter.

## Accessories

- Input HCSMU (16493S-020) or From HCSMU (16493A-021)  
Triaxial connector (Sense) and BNC connector (Force). For connecting 16493S HCSMU cable from the HCSMU.
  - Master Force/Sense  
Must be connected to Force/Sense of HCSMU used as the master.
  - Slave Force/Sense  
Must be connected to Force/Sense of HCSMU used as the slave.
- Input GNDU (16493S-020)  
GNDU triaxial connector. For connecting 16493L GNDU cable from the GNDU.

---

**NOTE**

---

Do not put any conductor on the HCSMU Low Force and Low Sense terminals, outer conductor of the coaxial connectors. Putting conductor of circuit common, chassis ground, or any potential on causes the measurement error.



## N1265A Ultra High Current Expander/Fixture

Test fixture which contains the current expander to enable 500 A or 1500 A (option N1265A-015) output and measurement, and contains the selector to switch the measurement resource connected to the DUT.

The current expander is used to configure ultra high current unit (UHCU) as described in “[Ultra High Current Unit](#)”.

The selector is used to switch the measurement resource connected to the DUT. The measurement resource will be the UHCU, HVSMU/HVMCU, or HP/MPSMU. The selector output can be extended to your prober station by using the N1254A-524 ultra high current prober system cable.

The N1265A also provides the connection paths for UHVU, MFCMU via bias-tee, and HP/MP/HC/MC/DHCSMU.

### Ultra High Current Unit

The ultra high current unit (UHCU) can be configured by using the N1265A and two MC/HCSMU modules as shown in [Figure 3-10](#). The UHCU output can appear on the Selector Output by controlling the built-in selector.

**Figure 3-10**

#### To Configure UHCU

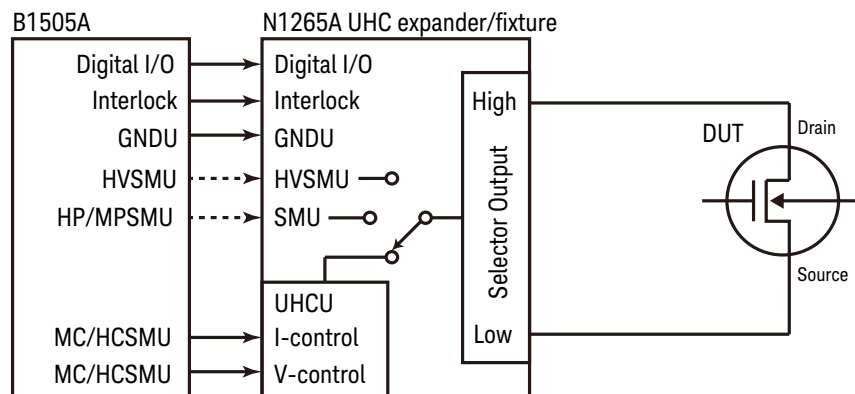

**NOTE**

For the gate terminal of DUT, use MCSMU or HCSMU.

## Front Panel

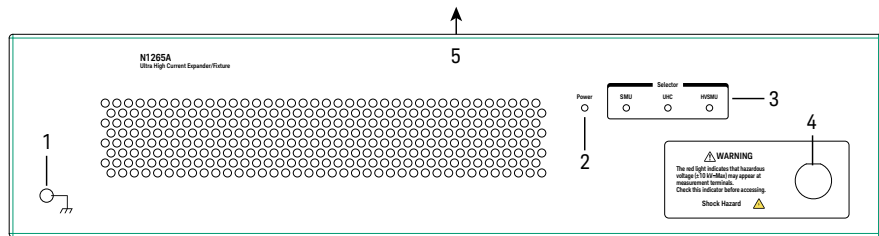

1. Terminal for connecting wrist strap

2. Power indicator

This LED turns yellow when the AC power is applied to the test fixture.

This LED turns green when the test fixture is ready to use.

3. Status indicator

A green LED lights to indicate the present connection path of the selector. See [Figure 3-11](#) and [Table 3-5](#) for the status indicator and the connection path.

 4. Hazardous voltage status indicator

This red LED lights when a measurement resource applies dangerous voltage.

This indicator is connected to the B1505A via the Interlock connector and works with the High Voltage indicator on the B1505A's front panel.

Warning labels written in French, German, and Japanese are furnished. Attach the label to the front panel of the fixture if you need.

### WARNING



**The red light indicates that hazardous voltage (maximum  $\pm 10$  kVdc) may appear at measurement terminals. Check this indicator before accessing.**

**Le témoin rouge indique qu'une tension dangereuse (maximum  $\pm 10$  kV CC) risque d'apparaître au niveau des bornes de mesure. Vérifiez cet indicateur avant d'accéder.**

5. Fixture cover

The fixture cover should be closed to avoid electrical shock by touching measurement terminals and to prevent a device under test from external noise.

When the fixture cover is open, maximum SMU output is limited to  $\pm 42$  V and UHVU output is disabled.

**WARNING**



Hazardous voltage, instrument maximum output voltage may appear at the High, Force, Guard, and Sense terminals if the fixture cover is closed.

Une tension dangereuse, une tension de sortie maximale de l'appareil peut apparaître aux bornes High, Force, Guard et Sense si le couvercle de l'équipement est fermé.

**WARNING**



Make sure that the cover is closed properly before starting measurement. Do not perform the measurement when a wire is protruding from the fixture cover.

Assurez-vous que le couvercle est fermé correctement avant de commencer la mesure. Ne pas effectuer la mesure lorsqu'un câble dépasse du couvercle de l'appareil.



**Rear Panel**

**WARNING**



Connect a wire from an electrical ground (safety ground) to this terminal.

Connectez un fil depuis une mise à la terre électrique (mise à la terre de sécurité) à la borne de terre.

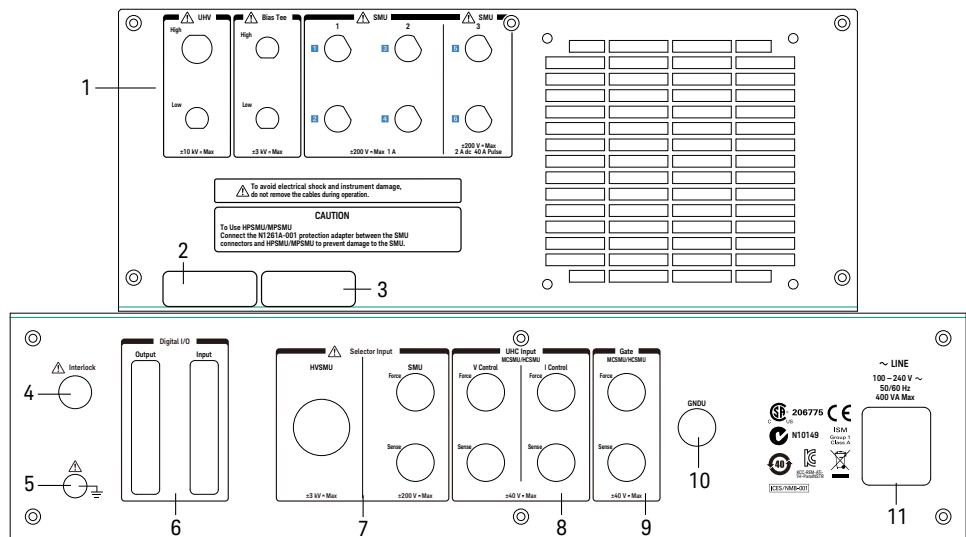



Table 3-3

SMU Input Connectors and Signals by SMU Type

Connected SMU	1 or 2		3	
	[1] or [3]	[2] or [4]	[5]	[6]
HP/MPSMU (non-Kelvin)	Force	Force	Force	Force
HP/MPSMU (Kelvin)	Force	Sense	Force	Sense
MCSMU	Force	Sense	Force	Sense
HCSMU or DHCSMU	NA		Force	Sense

 1. Input

- UHV High and Low connectors

UHV(jack) connector for High and SHV(jack) connector for Low. For connecting 16493V UHV cable from N1268A UHV expander.

- Bias Tee High and Low connectors

SHV(jack) connectors. For connecting N1254A-518 SHV cables from N1260A high voltage bias-tee connected to MFCMU.

- SMU 1 to 3 ([1] to [6]) connectors

Triaxial connectors. For connecting HP/MP/MCSMU. The SMU 3 ([5] and [6]) connectors can be also used to connect HCSMU or DHCSMU (Dual HCSMU). See [Table 3-3](#).

The connector [1]/[3]/[5] is for connecting Force, and the connector [2]/[4]/[6] is for connecting Sense of the measurement resource connected to the connector [1]/[3]/[5] respectively.

For connecting HP/MPSMU, the connector [2]/[4]/[6] can be also used to connect Force of other SMU if Kelvin connection is not made.

To connect HP/MPSMU, use N1261A-001 protection adapter and 16494A triaxial cables.

To connect MCSMU, use 16494A triaxial cables.

To connect HCSMU, use 16493S HCSMU cable, N1254A-103 adapter for Force, and N1254A-517 adapter for Sense.

To connect DHCSMU, use 16493S-021 adapter, 16493S HCSMU cables, N1254A-103 adapter for Force, and N1254A-517 adapter for Sense.

## 2. Serial number label

You need this *serial number* when using Keysight Technologies telephone assistance program.

## 3. Option number label

 4. Interlock connector

Interlock connector. For connecting 16493J interlock cable from B1505A.

**WARNING**

**Potentially hazardous voltage may be present at the High, Force, Sense, and Guard terminals when the interlock terminals are shorted on test fixture, prober station, and such.**

**Une tension potentiellement dangereuse peut être présente à la borne High lorsque les bornes de verrouillage sont court-circuitées sur l'équipement de test, la station de sonde et autres.**

 5. Earth terminal

Screw terminal for earthing.

## 6. Digital I/O connector

Input connector is for connecting 16493G cable from the Digital I/O connector of B1505A.

Output connector is for connecting 16493G cable to the Digital I/O connector of N1266A, N1268A expander or any accessory.

 7. Selector Input connectors

- HVSMU connector

HV(jack) connector. For connecting 16493T HVSMU cable from the HVSMU or the HVMCU High.

- SMU connectors

Force and Sense triaxial connectors. For connecting 16494A triaxial cable from the HP/MPSMU.

## 8. UHC Input connectors

Triaxial connectors. For connecting 16494A triaxial cables from Force and Sense connectors of the MCSMU. HCSMU is substitutable. Then use 16493S HCSMU cable, N1254A-103 adapter for Force, and N1254A-517 adapter for Sense.

9. Gate connectors

Triaxial connectors. For connecting 16494A triaxial cables from Force and Sense connectors of the MCSMU. HCSMU is substitutable. Then use 16493S HCSMU cable, N1254A-103 adapter for Force, and N1254A-517 adapter for Sense. Do not apply the current over 1 A to this port if the HCSMU is used. Maximum current is 1 A.

10. GNDU connector

GNDU triaxial connector. For connecting 16493L GNDU cable from the GNDU or the HVMCU Low.

11. LINE input receptacle and power switch

AC power cable is connected to this receptacle. Power switch turns on/off the N1265A. Paths other than the Selector Output do not need AC power.

## ⚠ Output Terminal Panel

### WARNING



Set the instrument output off before connecting or disconnecting connection wire.

Press the B1505A front panel Stop key to set the module output off. And confirm that the B1505A front panel High Voltage indicator is not lit.

If the N1268A is used, press the High Voltage Enable switch to disable the high voltage output. And confirm that this red switch is not lit.

Désactivez la sortie de l'appareil avant de brancher ou de débrancher un câble de connexion.

Appuyez sur la touche Stop du panneau avant du B1505A pour désactiver la sortie. Et confirmez que l'indicateur de tension High du panneau avant du B1505A n'est pas allumé.

Si le N1268A est utilisé, enfoncez le commutateur High Voltage Enable pour désactiver la sortie haute tension. Et confirmez que le commutateur rouge n'est pas allumé.

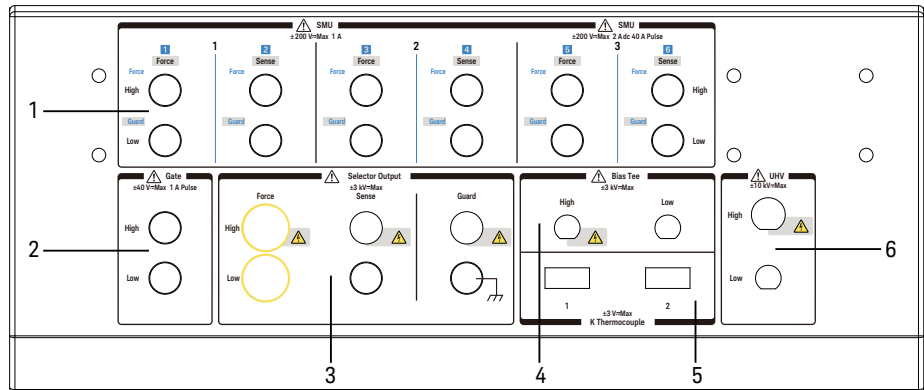

**Table 3-4 SMU Terminals and Signals by SMU Type**

Connected SMU	1 or 2		3		Designation on panel
	[1] or [3]	[2] or [4]	[5]	[6]	
HP/MPSMU (non-Kelvin)	Force	Force	Force	Force	Blue letters
	Guard	Guard	Guard	Guard	
HP/MPSMU (Kelvin)	Force	Sense	Force	Sense	Letters in white square
	Guard	Guard	Guard	Guard	
MCSMU	High Force	High Sense	High Force	High Sense	Black letters
	Low Force	Low Sense	Low Force	Low Sense	
HCSMU or DHCSMU	NA		High Force	High Sense	
	NA		Low Force	Low Sense	

 1. SMU 1 to 3 ([1] to [6]) terminals

Output terminals internally connected to the SMU input connectors on the rear panel. Force, Sense, and Guard terminals for HP/MPSMU. High Force, Low Force, High Sense, and Low Sense for HC/MC/DHCSMU. See [Table 3-4](#).

For using HP/MPSMU, Force must be connected to a terminal of a DUT. And Guard must be opened. You may extend it as close as possible to the DUT terminal for reducing the leakage current of the extension cable. Also, Force and Sense should be connected together at the device end for making the Kelvin connection effective for low resistance and high current measurements.

For using HC/MC/DHCSMU, High Force and High Sense must be connected together at the high terminal of a DUT. And Low Force and Low Sense must be connected together at the low terminal of the DUT. Also, Selector Output Low Force and Sense must be connected to the low terminal for connecting GNDU.

For the active device measurement using UHVU, use MCSMU and N1265A-040 protection adapter for the gate/base terminal and the chuck terminal. The adapter is required to protect MCSMU from ultra high voltage.

 2. Gate High and Low terminals

Output terminals internally connected to the Gate input connectors on the rear panel. High and Low terminals used for the gate drive.



Gate terminals are designed for using with the Selector Output terminals. See [Figure 3-11](#). High should be connected to the gate or base terminal of a DUT. Low should be connected to the source or emitter terminal of the DUT.

**CAUTION**

Open the Gate terminals for the ultra high voltage measurement using UHVU.



## 3. Selector Output

See [Figure 3-11](#) and [Table 3-5](#) for the status indicator and the connection path. For connecting a prober station, use the N1254A-524 system cable.

**CAUTION**

Open the terminals for the ultra high voltage measurement using UHVU.

## a. Low Force and Low Sense output terminals

Force and Sense must be connected together at the low terminal of a DUT. Use the banana-banana wire (N1254A-522) for performing the ultra high current measurement using UHCU.

## b. High Force and High Sense output terminals

Force and Sense must be connected together at the high terminal of a DUT. Use the banana-banana wire (N1254A-522) for performing the ultra high current measurement using UHCU.

## c. Guard terminal

Guard (high level) must be opened. You may extend it as close as possible to a DUT terminal for reducing the leakage current of the extension cable.

## d. Chassis common terminal

Use for grounding or shielding.

**NOTE**

Selector may emit a noise sound during operation. However it is not abnormal status.



## 4. Bias Tee High and Low terminals

Output terminals internally connected to the Bias Tee High and Low input connectors on the rear panel.

High and Low must be connected to the high and low terminals of a DUT respectively. Use SHV(plug)-SHV(plug) cable (N1254A-512) and SHV(jack)-banana adapter (N1254A-513) for connection.

**CAUTION**

Open the Bias Tee terminals for the ultra high voltage measurement using UHVU.

5. K Thermocouple 1 and 2 terminals

For connecting the thermocouple to monitor temperature around a DUT.

The N1265A-041 thermocouple supports maximum of +180 °C.

The N1254A-554 thermocouple supports maximum of +250 °C.

 6. UHV High and Low terminals

Output terminals internally connected to the UHV High and Low input connectors on the rear panel.

High and Low must be connected to the high and low terminals of a DUT respectively. Use the blank silicon plate and the UHV/SHV to no connector cables (N1254A-520) for connection. Also see [“Blank Silicon Plate” on page 3-52](#).

**CAUTION**

Open the Gate terminals, the Selector Output terminals, and the Bias Tee terminals for the ultra high voltage measurement using the UHVU.

**Figure 3-11 N1265A Built-in Selector Simplified Internal Connections**

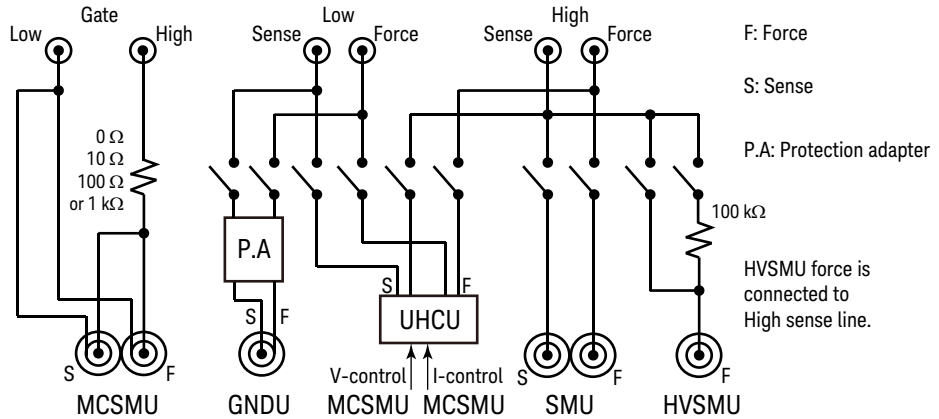

**Table 3-5 N1265A Status Indicator and Selector Connection Path**

Status indicator	Selector Output terminals			
	Low Sense	Low Force	High Sense	High Force
(off)	Open	Open	Open	Open
	GNDU Sense	GNDU Force	Open	Open
SMU	GNDU Sense	GNDU Force	SMU Sense	SMU Force
UHC	UHCU Low Sense	UHCU Low Force	UHCU High Sense	UHCU High Force
HVSMU	GNDU Sense	GNDU Force	HVSMU Force	Open
	GNDU Sense	GNDU Force	HVSMU Force + Series resistor	Open

**CAUTION**

Never connect the UHVU High terminal to any output, including circuit common, chassis ground, or any other measurement resource such as SMU. Connecting other measurement resource may damage the connected one.

**CAUTION**

For the ultra high voltage measurement of active device, connect the UHVU High terminal to the drain/collector terminal of a DUT. And for connecting the gate/base terminal and the chuck terminal, use two SMU output terminals which are connected to MCSMU and are attaching the N1265A-040 protection adapter. Then connect a High terminal to the gate/base terminal, and the another High terminal to the chuck terminal. And connect all three Low terminals to the source/emitter terminal.

For the other cases, never connect any other measurement resource to the UHVU Low terminal or the DUT terminal connected to it. Connecting other measurement resource may damage the connected one.

---

**WARNING**



Before touching the DUT after the ultra high voltage measurement using the UHVU, confirm that it has been discharged enough. For that, use right hand, ground and discharge the terminals over 10 seconds after stopping the high voltage output, and confirm that they have been safety voltage by using another volt meter.

Especially, it is dangerous if a capacitive load or a long cable is connected. When a large load capacitance is connected, the terminals may not have been discharged until the safety voltage below  $\pm 42$  V.

Avant de toucher le MST après la mesure de la tension ultra élevée avec l'UHVU, confirmez qu'il a été suffisamment déchargé. Pour cela, avec la main droite, mettez à la terre et déchargez les bornes plus de 10 secondes après l'arrêt de la tension de sortie élevée et confirmez que la tension est sécurisée en utilisant un autre voltmètre.

En particulier, cela peut être dangereux si une charge capacitive ou un câble long est connecté(e). Lorsqu'une grande capacité de charge est connectée, les bornes peuvent ne pas avoir été déchargées jusqu'à ce que la tension de sécurité soit en dessous de  $\pm 42$  V.

---

### Socket Modules, Blank Plate, and Adapters

---

**WARNING**



Set the instrument output off before connecting or disconnecting connection wire.

Press the B1505A front panel Stop key to set the module output off. And confirm that the B1505A front panel High Voltage indicator is not lit.

If the N1268A is used, press the High Voltage Enable switch to disable the high voltage output. And confirm that this red switch is not lit.

Désactivez la sortie de l'appareil avant de brancher ou de débrancher un câble de connexion.

Appuyez sur la touche Stop du panneau avant du B1505A pour désactiver la sortie. Et confirmez que l'indicateur de tension High du panneau avant du B1505A n'est pas allumé.

Si le N1268A est utilisé, enfoncez le commutateur High Voltage Enable pour désactiver la sortie haute tension. Et confirmez que le commutateur rouge n'est pas allumé.

---

---

**WARNING**

**To prevent electrical shock and DUT damage, do not connect or disconnect the DUT while the instrument is applying voltage or current.**

**When you touch the DUT after measurement, devise a countermeasure of residual charge and heat to prevent electrical shock and burn. Use gloves and any tool. Also have enough time for discharge and radiation.**

**Afin d'éviter toute décharge électrique et dommage MST, ne branchez ou débranchez pas la sortie MST alors que l'appareil envoie de la tension ou du courant.**

**Lorsque vous touchez le MST après la mesure, élaborer une contre-mesure de la charge résiduelle et du chauffage afin d'éviter tout choc électrique et toute brûlure. Utilisez des gants et des outils. Prévoyez également du temps pour la décharge et la radiation.**

---



- Inline Package Socket Module (N1265A-010)

This module provides a socket used for connecting three-terminal inline packaged device and three couples of the Force and Sense terminals. Socket module internal connection is shown in [Figure 3-12](#).

Short bar is furnished with the module. It is used for performing the short correction before the impedance measurement. Set the short bar before the short correction and remove it after the correction.

To use this module, see the following simple instruction.

1. Attach the socket module to the test fixture.
2. Connect wires between the socket module terminals and the fixture output terminals. Then use the following wire (furnished with the N1265A-010).
  - 180 mm length wire (yellow) for Selector Output High/Low Force
  - 180 mm length wire for Selector Output High/Low Sense
  - 250 mm length wire for Gate, SMU, or chassis

For making the Kelvin connection, Force and Sense must be connected to Force and Sense of the socket module respectively.

For the high voltage capacitance measurement, use SHV(plug)-SHV(plug) cable (N1254A-512) and SHV(jack)-banana adapter (N1254A-513) for connection.

Selector Output and Gate should be connected as follows.

- Selector Output High to DUT high (ex. Collector/Drain)

- Selector Output Low to DUT low (ex. Emitter/Source)
- Gate High to DUT drive (ex. Base/Gate Force)
- Gate Low to DUT low (ex. Emitter/Source Force)

HC/MC/DHCSMU via SMU 3 terminals should be connected as follows.

- SMU 3 High Force and Sense to DUT high
- SMU 3 Low Force and Sense to DUT low
- GNDU Force and Sense to DUT low

The GNDU signals will appear at the Selector Output Low terminals as shown in [Table 3-5](#).

3. Set the DUT on the socket.
4. Close the fixture cover and perform measurement.

**CAUTION**

Do not apply voltage/current over the maximum limit of the socket module.

**Figure 3-12 Inline Package Socket Module**

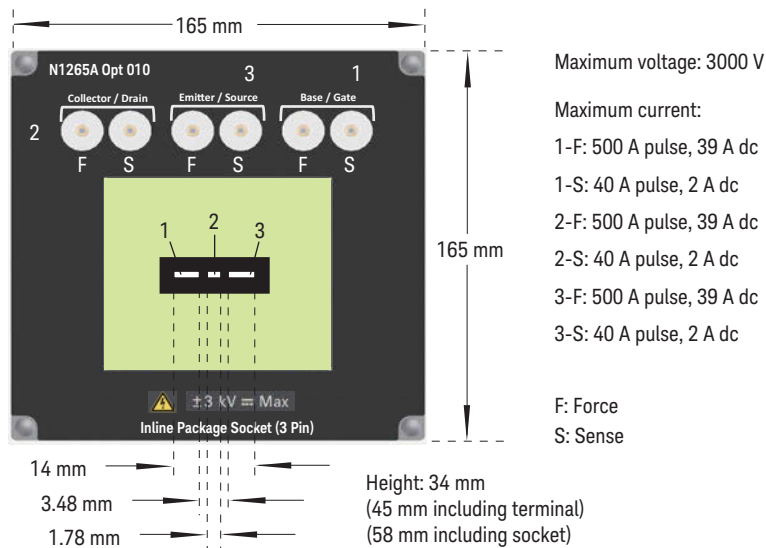

⚠ • Universal Socket Module (N1265A-011)

This is a blank module, kind of a do-it-yourself kit for supporting variety of packaged devices. This module can be used by mounting your desired socket or packaged device and making connections same as the N1265A-010 Inline Package Socket Module.

To use this module, see the following simple instruction. For the component locations and dimensions, see [Figure 3-13](#). Also see [“Inline Package Socket Module \(N1265A-010\)”](#) on page 3-45 to perform measurement.

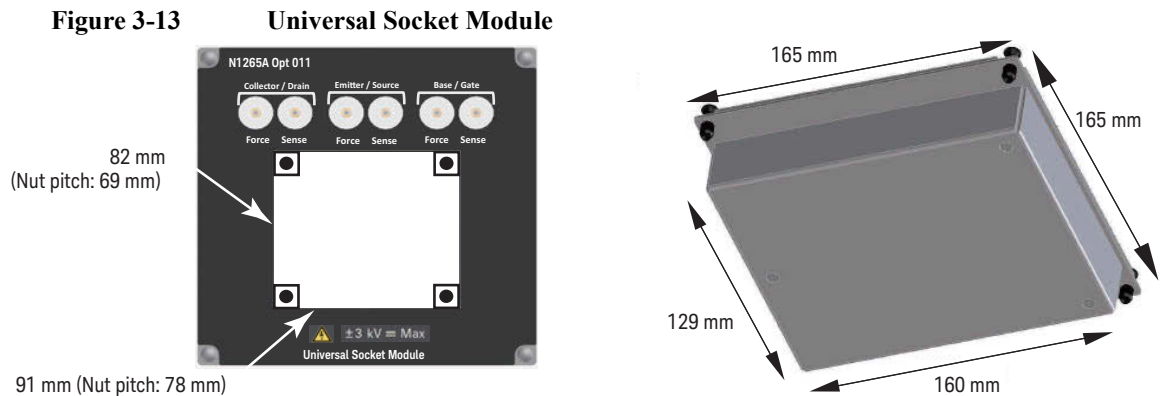

1. Prepare the following parts.
  - blank board suitable for mounting the socket or packaged device
  - screw M3, 4 ea., for fixing the blank board on the socket module
  - wire, adequate length and quantity, for making connections
  - hexlobe (torx type) screwdriver T-10
  - socket, if you use, and packaged device under test (DUT)
2. Cut the blank board in 90 mm × 81 mm square.
3. Make four screw holes on the board. The holes should be 6 mm inside from the edge.
4. Fix the board to the blank module.
5. Remove the cover bottom of the blank module.
6. Mount the socket or DUT on the board and solder wire between its terminals and the blank module terminals.

**WARNING**

Make enough space between the socket/DUT terminal and the shield/chassis, for example, about 1 mm for maximum 200 V output and 6 mm for 3000 V, to prevent discharge and any accident.

Laissez suffisamment d'espace entre la prise/la borne MST et la protection/le châssis. Par exemple, environ 1 mm pour une sortie de 200 V au maximum et 6 mm pour 3 000 V afin d'éviter toute décharge et tout accident.

7. Reattach the cover.

- Curve Tracer Test Adapter Socket Module (N1265A-013)

This module provides a socket available for connecting a test adapter designed for connecting to Tektronix 370B/371B curve tracers. Socket module internal connection is shown in [Figure 3-14](#).

To use this module, see the following simple instruction.

**Figure 3-14** Curve Tracer Test Adapter Socket Module

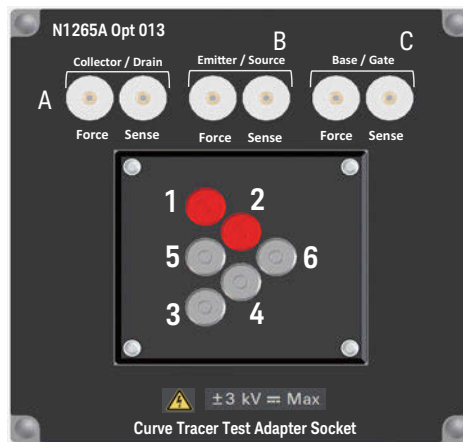

Internal connection

- 1: Collector/Drain Force
- 2: Collector/Drain Sense
- 3: Emitter/Source Force
- 4: Emitter/Source Sense
- 5: Base/Gate Force
- 6: Base/Gate Sense

Maximum voltage: 3000 V

Maximum current:

- A-Force: 500 A pulse, 39 A dc
- A-Sense: 40 A pulse, 2 A dc
- B-Force: 500 A pulse, 39 A dc
- B-Sense: 40 A pulse, 2 A dc
- C-Force: 40 A pulse, 2 A dc
- C-Sense: 40 A pulse, 2 A dc

1. Attach the socket module to the test fixture.
2. Connect your test adapter to the socket.
3. Connect wires between the socket module terminals and the fixture output terminals. Then use the following wire.
  - N1254A-522 wire (yellow) for Selector Output High/Low Force
  - N1254A-508 or 509 wire for Selector Output High/Low Sense, Gate, SMU, or chassis



For making the Kelvin connection, Force and Sense must be connected to Force and Sense of the socket module respectively.

For the high voltage capacitance measurement, use SHV(plug)-SHV(plug) cable (N1254A-512) and SHV(jack)-banana adapter (N1254A-513) for connection.

---

**CAUTION**

---

Do not apply voltage/current over the maximum limit of the socket module.

Selector Output and Gate should be connected as follows.

- Selector Output High to DUT high (ex. Collector/Drain)
- Selector Output Low to DUT low (ex. Emitter/Source)
- Gate High to DUT drive (ex. Base/Gate Force)
- Gate Low to DUT low (ex. Emitter/Source Force)

HC/MC/DHCSMU via SMU 3 terminals should be connected as follows.

- SMU 3 High Force and Sense to DUT high
- SMU 3 Low Force and Sense to DUT low
- GNDU Force and Sense to DUT low

The GNDU signals will appear at the Selector Output Low terminals as shown in [Table 3-5](#).

4. Set the DUT on your test adapter.
  5. Close the fixture cover and perform measurement.
- Gate charge socket module (N1265A-014)

This socket adapter is designed for performing the gate charge measurement.

To use this module, see the following simple instruction.

1. Attach the socket module to the test fixture.
2. Connect wires between the socket module terminals and the fixture output terminals. You can use the following wires supplied with the socket module.
  - N1254A-522: high current wire (yellow), 2 ea.
  - N1254A-508: long wire (red), 2 ea.
  - N1254A-509: long wire (black), 2 ea.
  - N1265-61751: short wire (red), 2 ea.

- N1265-61752: short wire (black), 2 ea.

For making the Kelvin connection, Force and Sense must be connected together at the device terminal.

Figure 3-16 and Figure 3-17 show connection examples.

3. Set the current control device on the left socket or connect the load resistor between the studs for the resistor.

The current control device must be an extra 3-pin inline package device which is expected to have the same characteristics as DUT. If the device is not available, use a load resistor. The resistor must satisfy the following specifications.

$$\text{Resistance} = V_r / I_r \quad (V_r: \text{rated voltage}, I_r: \text{rated current})$$

$$\text{Peak power} \geq V_r \times I_r \times 1 \text{ ms}$$

4. Set your DUT on the right socket.
5. Close the fixture cover and perform measurement.

**CAUTION**

Do not apply voltage/current over the maximum limit of the socket module.

**Figure 3-15 Gate Charge Socket Module**

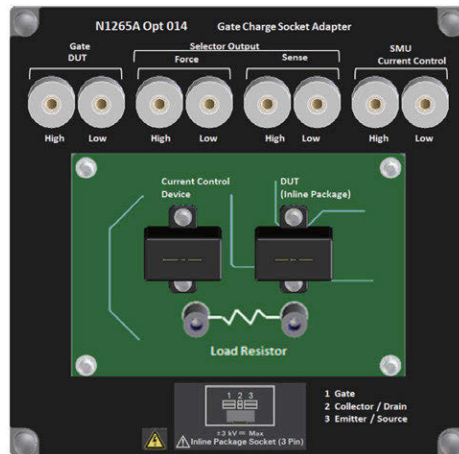

**Gate DUT**

High: Max. 30 V / 1 A

Low: Max. 10 V / 1 A

**Selector Out Force**

High: Max. 3000 V / 500 A

Low: Max. 10 V / 500 A

**Selector Out Sense**

High: Max. 3000 V / 20 mA

Low: Max. 10 V / 20 mA

**SMU Current Control**

High: Max. 30 V / 1A floating 3000 V

Low: Max. 10 V / 1A floating 3000 V

**Figure 3-16 Connection Example for High Current Gate Charge Measurement**

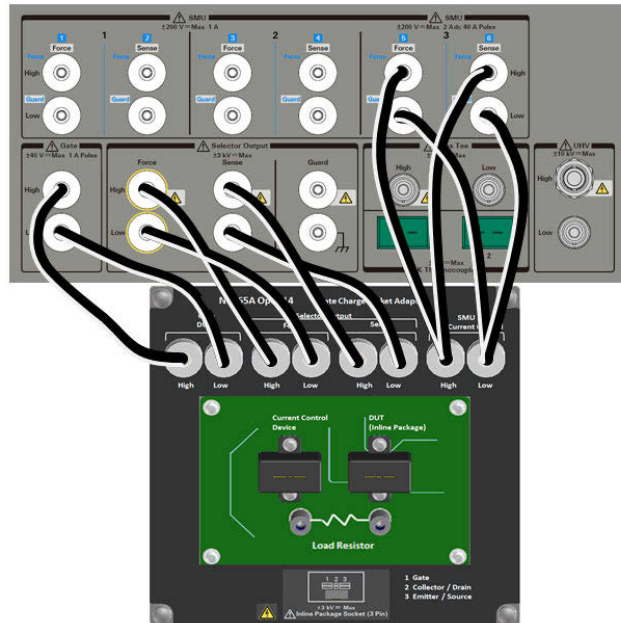

**Figure 3-17 Connection Example for High Voltage Gate Charge Measurement**

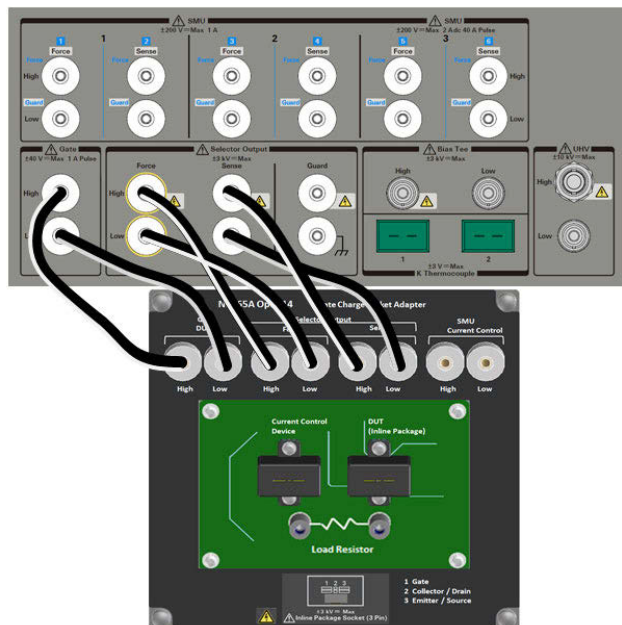

- Blank Silicon Plate

This is an insulation board used for placing a DUT. To use this board, see the following simple instruction.

1. Prepare a DUT and cable or wire, adequate length and quantity, for making connections. The following accessories are available.
  - N1254A-520 UHV/SHV to no connector cables for UHV High/Low
  - N1254A-522 banana-banana wire (yellow) or N1254A-523 banana to no connector wire (yellow) for Selector Output High/Low Force
  - N1254A-508 or 509 connection wire for Selector Output High/Low Sense, Gate, SMU, and chassis
  - N1254A-512 SHV cable and N1254A-513 adapter for capacitance measurement (Bias Tee terminals)
  - N1254A-510 dolphin clip adapter or N1254A-511 cable lug adapter
2. Attach the blank silicon plate to the test fixture.
3. Connect cable/wire between the DUT and the fixture output terminals.

For making the Kelvin connection, Force and Sense must be connected to Force and Sense of the socket module respectively.

Selector Output and Gate should be connected as follows.

- Selector Output High to DUT high (ex. Collector/Drain)
- Selector Output Low to DUT low (ex. Emitter/Source)
- Gate High to DUT drive (ex. Base/Gate Force)
- Gate Low to DUT low (ex. Emitter/Source Force)

HC/MC/DHCSMU via SMU 3 terminals should be connected as follows.

- SMU 3 High Force and Sense to DUT high
- SMU 3 Low Force and Sense to DUT low
- GNDU Force and Sense to DUT low

The GNDU signals will appear at the Selector Output Low terminals as shown in [Table 3-5](#).

4. Make sure the DUT location. The DUT must be placed on the blank silicon plate properly.

Make enough space between the High-Low cable ends, also between the high side cable end and the shield/chassis, for example, about 1 mm for maximum 200 V output, 6 mm for 3000 V, and 32 mm for 10 kV, to prevent discharge and any accident. Also the creepage distance must be more than 100 mm for 10 kV.

5. Close the fixture cover before starting measurement.

**Figure 3-18 Space around Cable End**

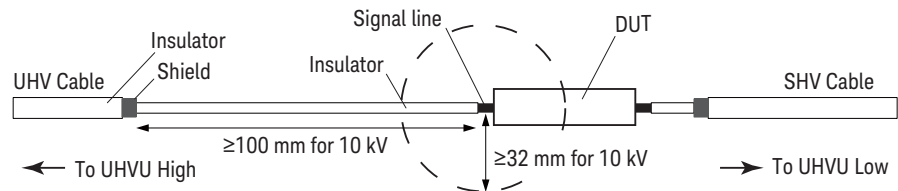

**WARNING**



**Wrap an insulator around the naked conductors of coaxial cable to avoid touching it.**

**Enroulez un isolant autour des conducteurs dénudés du câble coaxial afin d'éviter de les toucher.**



- Universal resistor Box (N1265A-035)

This is a blank box, kind of a do-it-yourself kit for installing a resistor you want. Generally, inserting a resistor between SMU and DUT is effective for reducing damage of DUT or preventing SMU from oscillation. You can insert your desired resistor by using this box. This box is designed for using the MCSMU.



- Protection Adapter (N1265A-040)

This is the adapter for protecting MCSMU from ultra high voltage. For active device measurement using UHVU, use MCSMU and this adapter for the gate/base and chuck terminals. This adapter must be attached to the SMU terminals for preventing MCSMU from damage.

- Container (N1265A-045)

This container can accommodate protection adapters and bias-tee which are used with the N1265A to make the measurement environment clean and safe.

Maximum superimposed load is 50 kg. The N1265A and the N1266A can be put on the top of the container.



- Prober System Cable (N1254A-524)

This is the cable for extending the N1265A's Selector Output and Gate terminals to a prober station. Cable length is 1.8 m. Prober side connector type and the maximum voltage/current are shown in **Table 3-6**.

This cable internally connects Selector Output Low Sense and Gate Low.

**Table 3-6 Prober Side Connectors and Maximum Voltage/Current of N1254A-524**

Connector label	Connector type	N1265A output terminals to extend	Maximum voltage	Maximum current
High Force	Banana(jack)	Selector Output High Force	3000 V	39 A dc, 500 A pulse <sup>a</sup>
Low Force	Banana(jack)	Selector Output Low Force	200 V	
High Sense	HV(jack)	Selector Output High Sense	3000 V	1 A dc, 20 A pulse
Low Sense	BNC(f)	Selector Output Low Sense	200 V	
		Gate Low		
Gate	BNC(f)	Gate High	200 V	

a. Pulse of 1 ms pulse width and 0.4 % duty cycle

**WARNING**



**For using the prober system cable safely**

**Never connect the interlock cable to the N1265A.**

**Never leave and use the N1265A in the condition that the clear plastic plates are removed from its fixture cover.**

**Pour utiliser le système de sonde en toute sécurité**

**Ne jamais connecter le câble de verrouillage au N1265A.**

**Ne jamais ôter les plaques en plastique transparent du couvercle d'appareil du N1265A.**

**CAUTION**

Do not apply voltage/current over the maximum limit of the cable.

## N1266A HVSMU Current Expander

Current expander for HVSMU. The N1266A is used to configure the high voltage medium current unit (HVMCU) with the HVSMU module and two MC/HCSMU modules as shown in Figure 3-19. The output can be selected from the HVSMU or HVMCU.

Figure 3-19

### To Configure HVMCU

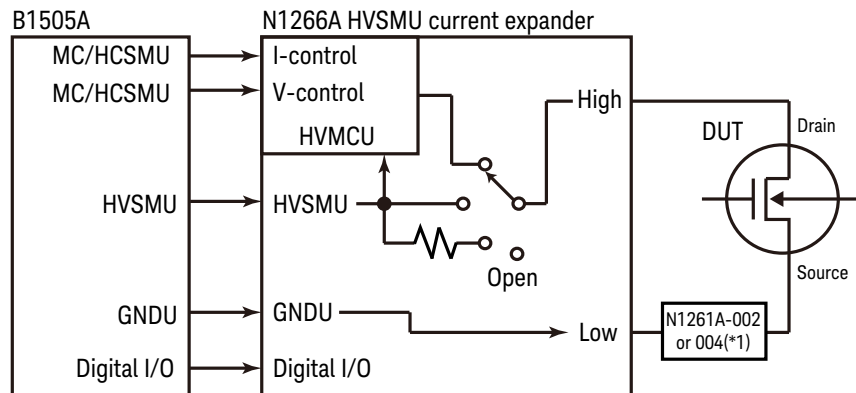

\*1: N1261A-002/004 protection adapter is required for connecting prober.  
Not required for connecting N1258A, N1259A, N1259A-300, or N1265A.

Table 3-7

### N1266A Status Indicator and Input-to-Output Connection Path

Status indicator	Input-to-output connection of output terminals	
	Low	High
(off)	GNDU Force and Sense	Open
HVMCU		HVMCU High
HVSMU		HVSMU Force
		HVSMU Force + Series resistor

#### NOTE

For the gate terminal of DUT, use MCSMU or HCSMU.

- Power indicator

This LED turns yellow when the AC power is applied to the N1266A.

This LED turns green when the N1266A is ready to use.

- Status indicator

A green LED lights to indicate the measurement resource ready to use.

**HVMC** High voltage medium current unit (HVMCU)

**HVSMU** High voltage source/monitor unit (HVSMU)



- Output High

HV(jack) connector. Force must be extended to a terminal of a DUT. Guard must be opened but should be extended as close as possible to the device terminal for reducing the leakage current of the extension cable. Use 16493T HVSMU cable to connect test fixture or adapter.

To connect prober, use high voltage triaxial cable with HV(plug) connector, manipulator, and such.

---

**CAUTION**

---

Never connect the HVMCU High terminal to any output, including circuit common, chassis ground, or any other measurement resource such as SMU. Connecting other measurement resource may damage the connected one.

- Output Low

Triaxial connector. Force and sense must be extended to a terminal of a DUT and connected together at the device end. Use 16493L GNDU cable to connect test fixture or adapter.

To connect prober, use N1261A-002/004 protection adapter and a cable with BNC(m) or SHV(plug) connector, manipulator, and such.



- Input HVSMU

HV(jack) connector. For connecting 16493T HVSMU cable from the HVSMU.

- Input GNDU

Triaxial connector. For connecting 16493L GNDU cable from the GNDU.

- Input V Control Force and Sense

Triaxial connectors. For connecting 16494A triaxial cables from Force and Sense connectors of the MCSMU. HCSMU is substitutable. Then use 16493S HCSMU cable, N1254A-103 adapter for Force, and N1254A-517 adapter for Sense.



- **Input I Control Force and Sense**  
Triaxial connectors. For connecting 16494A triaxial cables from Force and Sense connectors of the MCSMU. HCSMU is substitutable. Then use 16493S HCSMU cable, N1254A-103 adapter for Force, and N1254A-517 adapter for Sense.
- **Digital I/O connector Output**  
For connecting 16493G cable to the Digital I/O connector of N1268A expander, module selector, or any accessory.
- **Digital I/O connector Input**  
For connecting 16493G cable from the Digital I/O connector of B1505A or N1265A fixture.
- **LINE input receptacle and power switch**  
AC power cable is connected to this receptacle. Power switch turns on/off the N1266A.

## N1267A HVSMU/HCSMU Fast Switch

The N1267A is used to switch quickly and automatically the measurement resource, HVSMU or HCSMU, connected to the DUT. This is effective for the current collapse measurement of GaN power devices. One MCSMU module is required to control switching.

Figure 3-20

### N1267A Simplified Internal Connections

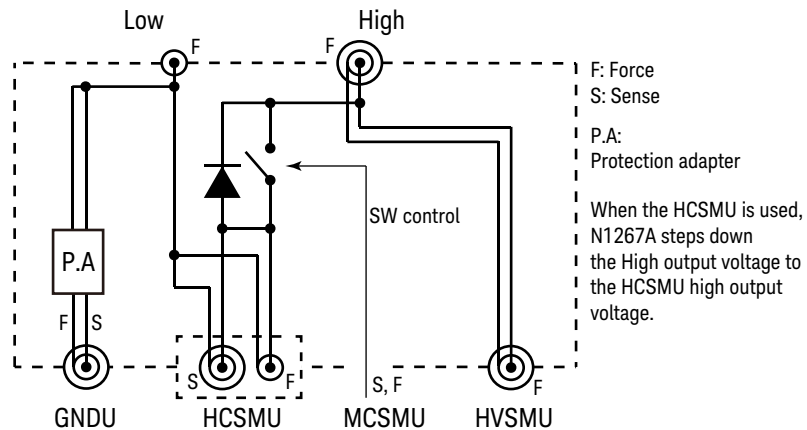

#### NOTE

For the gate terminal of DUT, use MCSMU or HCSMU. See [Figure 3-21](#).

- Output Low Force

BNC connector.

Force must be extended to a low terminal of a device under test (DUT). Then use a cable with BNC(m) connector, manipulator, and such.



- Output High Force

HV(jack) connector.

Force must be extended to a high terminal of the DUT. Then use a cable with HV(plug) connector, manipulator, and such.

Guard must be opened.

#### CAUTION

Never connect the output High Force and Guard terminals to any output, including circuit common, chassis ground, or any other measurement resource such as SMU. Connecting other measurement resource may damage the connected one.

- Input GNDU  
GNDU triaxial connector. For connecting 16493L GNDU cable from the GNDU.
- Input HCSMU  
Force BNC connector and Sense triaxial connector. For connecting 16493S HCSMU cable from the HCSMU.
- Input MCSMU  
Triaxial connectors. For connecting 16494A triaxial cables from Force and Sense connectors of the MCSMU.
- Input HVSMU  
HV(jack) connector. For connecting 16493T HVSMU cable from the HVSMU.

### GaN Current Collapse Measurement

The GaN current collapse measurement can be performed by using the N1267A and the B1505A installed with HVSMU, HCSMU, MCSMU, and GNDU. These measurement resources must be connected as shown in [Figure 3-21](#). For making the Kelvin connection, the GNDU protection adapter is also required. Then HVSMU and GNDU must be connected to the device under test (DUT) without passing through the N1267A. If the DUT is a diode, ignore *MCSMU for Gate* in [Figure 3-21](#).

The B1505A provides the following tracer test setup using the N1267A.

- GaN FET (N1267A):
  - Id-Vds static characteristics measurement
  - Id(Off)-Vds static characteristics measurement
  - Id-Vds current collapse measurement
  - FET current collapse measurement, oscilloscope view
- GaN Diode (N1267A):
  - If-Vf static characteristics measurement
  - Ir-Vr static characteristics measurement
  - If-Vf current collapse measurement
  - Diode current collapse measurement, oscilloscope view

The B1505A also provides the following application test definitions.

- GaN FET:
  - FET current collapse measurement, IV-t sampling
  - FET current collapse measurement, signal monitor
- GaN Diode:
  - Diode current collapse measurement, IV-t sampling
  - Diode current collapse measurement, signal monitor

Figure 3-21

**Connections for GaN Current Collapse Measurement**

Non-Kelvin connection

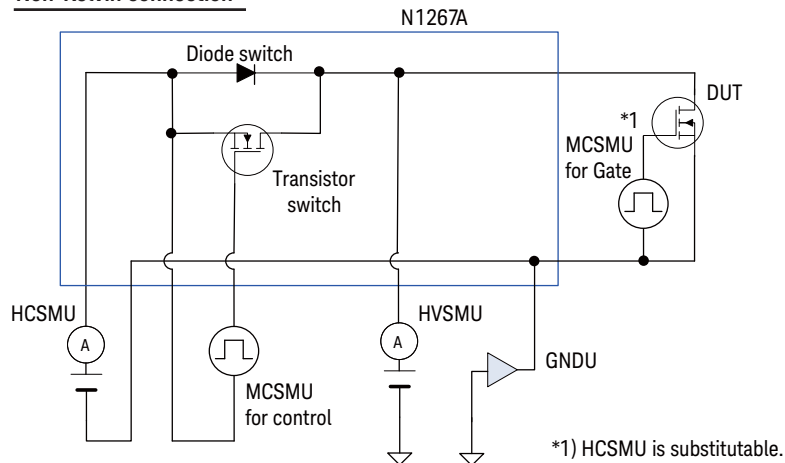

Kelvin connection

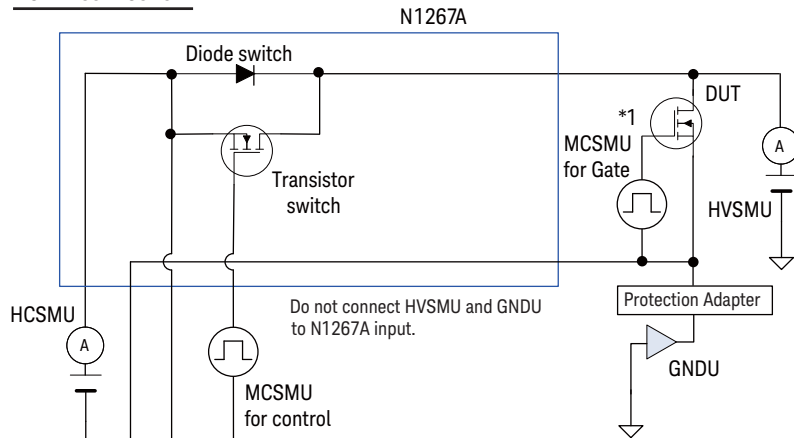

## Voltage/Current Source and Measurement Range

Source and measurement range using HVSMU and HCSMU with the N1267A is shown in [Figure 3-22](#).

Figure 3-22

### Source and Measurement Range

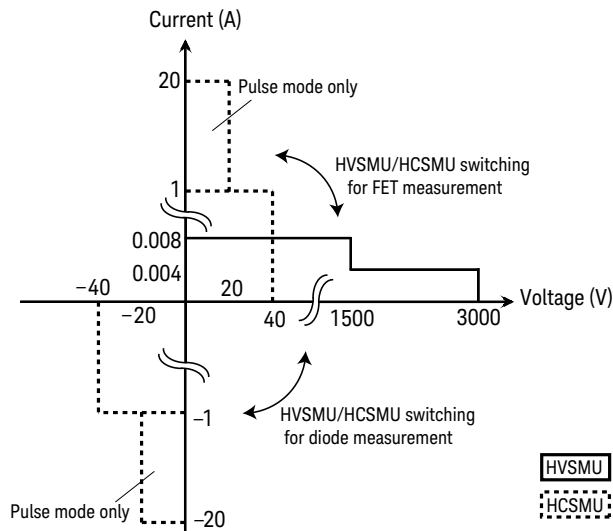

For the GaN current collapse measurement, HVSMU applies high voltage stress to the device under test (DUT) when it is in the OFF state. After that, HVSMU performs voltage measurement and HCSMU performs I-V measurement to monitor the ON state characteristics which is given by the voltage measured by HVSMU and the total current measured by HCSMU and HVSMU.

Source setting values available for HVSMU and HCSMU are shown in [Tables 3-8](#) and [3-9](#). And measurement ranges are shown in [Tables 3-10](#) and [3-11](#).

Table 3-8

### HVSMU Source Setting Range for OFF State

Range	Setting value <sup>a</sup>	Resolution	Compliance
200 V	1 V to 200 V	200 $\mu$ V	8 mA
500 V	1 V to 500 V	500 $\mu$ V	
1500 V	1 V to 1500 V	1.5 mV	
3000 V	1 V to 3000 V	3 mV	4 mA

a. Setting value must be the ON state voltage plus 1 V or more.

**Table 3-9 HCSMU Source Setting Range for ON State**

Range	Setting value <sup>a</sup>	Resolution	Compliance
2 V	0 V to 2 V	2 $\mu$ V	20 mA to 1 A DC, or 20 mA to 20 A pulse
20 V	0 V to 20 V	20 $\mu$ V	
40 V	0 V to 40 V	40 $\mu$ V	20 mA to 1 A DC

a. Voltage actually applied to the device under test (DUT) is the setting value minus the voltage drop of the switch.

**Table 3-10 HVSMU Voltage Measurement Range**

Range <sup>a</sup>	Measurement value	Resolution
200 V	0 V to 200 V	200 $\mu$ V
500 V	0 V to 500 V	500 $\mu$ V
1500 V	0 V to 1500 V	1.5 mV
3000 V	0 V to 3000 V	3 mV

a. Range depends on the HVSMU source setting for the device OFF state.

**Table 3-11 Current Measurement Range**

HCSMU		HVSMU	
Range <sup>a</sup>	Resolution	Range	Resolution
100 mA	100 nA	10 mA	10 nA
1 A	1 $\mu$ A		
20 A (pulse)	20 $\mu$ A		

a. Range depends on the HCSMU source setting for the device ON state.

Following tables are for the ON state static characteristics measurements. The N1267A keeps switch ON status. HCSMU performs I-V measurement. HVSMU applies 0 V with 1  $\mu\text{A}$  compliance and measures  $V_{\text{ds}}$  or  $V_{\text{f}}$ .  $I_{\text{d}}$  or  $I_{\text{f}}$  is given by the total current measured by HCSMU and HVSMU.

**Table 3-12 Source Setting Range for  $I_{\text{d}}\text{-}V_{\text{ds}}$ ,  $I_{\text{f}}\text{-}V_{\text{f}}$  Measurement**

HCSMU source setting				HVSMU source setting
Range	Setting value	Resolution	Compliance	
2 V	0 V to 2 V	2 $\mu\text{V}$	10 $\mu\text{A}$ to 1 A DC, or 10 $\mu\text{A}$ to 20 A pulse	0 V output with 1 $\mu\text{A}$ compliance
20 V	0 V to 20 V	20 $\mu\text{V}$		
40 V	0 V to 40 V	40 $\mu\text{V}$	10 $\mu\text{A}$ to 1 A DC	

**Table 3-13 HVSMU Voltage Measurement Range for  $I_{\text{d}}\text{-}V_{\text{ds}}$ ,  $I_{\text{f}}\text{-}V_{\text{f}}$  Measurement**

Range	Measurement value	Resolution
200 V	0 V to 200 V	200 $\mu\text{V}$

**Table 3-14 Current Measurement Range for  $I_{\text{d}}\text{-}V_{\text{ds}}$ ,  $I_{\text{f}}\text{-}V_{\text{f}}$  Measurement**

HCSMU		HVSMU	
Range	Resolution	Range	Resolution
10 $\mu\text{A}$	10 pA	1 $\mu\text{A}$	10 nA
100 $\mu\text{A}$	100 pA		
1 mA	1 nA		
10 mA	10 nA		
100 mA	100 nA		
1 A	1 $\mu\text{A}$		
20 A (pulse)	20 $\mu\text{A}$		

Offset error for the  $I_{\text{d}}\text{-}V_{\text{ds}}$ ,  $I_{\text{f}}\text{-}V_{\text{f}}$  measurement is typical 1  $\mu\text{A}$ .

Following tables are for the OFF state static characteristics measurements. The N1267A keeps switch OFF status. HCSMU applies 0 V. HVSMU performs I-V measurement and measures Vds or Vr. Id(Off) or Ir is given by the total current measured by HCSMU and HVSMU.

**Table 3-15 Source Setting Range for Id(Off)-Vds, Ir-Vr Measurement**

HVSMU source setting				HCSMU source setting
Range	Setting value	Resolution	Compliance	
200 V	0 V to 200 V	200 $\mu$ V	10 $\mu$ A to 8 mA	0 V output with compliance more than HVSMU compliance
500 V	0 V to 500 V	500 $\mu$ V		
1500 V	0 V to 1500 V	1.5 mV		
3000 V	0 V to 3000 V	3 mV	10 $\mu$ A to 4 mA	

**Table 3-16 HVSMU Voltage Measurement Range for Id(Off)-Vds, Ir-Vr Measurement**

Range	Measurement value	Resolution
200 V	0 V to 200 V	200 $\mu$ V
500 V	0 V to 500 V	500 $\mu$ V
1500 V	0 V to 1500 V	1.5 mV
3000 V	0 V to 3000 V	3 mV

**Table 3-17 Current Measurement Range for Id(Off)-Vds, Ir-Vr Measurement**

HVSMU		HCSMU	
Range	Resolution	Range	Resolution
10 $\mu$ A	10 pA	10 $\mu$ A	10 pA
100 $\mu$ A	100 pA	100 $\mu$ A	100 pA
1 mA	1 nA	1 mA	1 nA
10 mA	10 nA	10 mA	10 nA

Leak error for the Id(Off)-Vds, Ir-Vr measurement is typical 2 nA.



## Switch Control Terminals

The N1267A has the Switch Control (MCSMU Force and Sense) terminals for controlling the N1267A ON/OFF status. Requirements for the terminals are listed below.

- Control voltage to set the N1267A OFF status: 0 V
- Control voltage to set the N1267A ON status: 15 V
- Current compliance: 100 mA
- Input voltage: 0 V to +18 V
- Voltage limit (input protection): -0.6 V to +20 V

## Duration and Sampling Settings

For current collapse measurement (tracer test):

- OFF state duration: 10 ms to 655.35 s, in 10 ms resolution

For current collapse measurement, oscilloscope view or signal monitor:

- OFF state duration: 10 ms to 655.35 s, in 10 ms resolution
- ON state duration for 20 A range: 50  $\mu$ s to 1 ms, in 2  $\mu$ s resolution
- ON state duration for 1 A range and below: 50  $\mu$ s to 2 s, in 2  $\mu$ s resolution
- Sampling duration: maximum 24 ms
- Sampling rate: 6  $\mu$ s for voltage, 2  $\mu$ s to 12  $\mu$ s for current

For current collapse measurement, IV-t sampling:

- OFF state duration: 10 ms to 655.35 s, in 10 ms resolution
- Minimum sampling interval, linear sampling: 200  $\mu$ s
- Maximum number of samples, linear sampling: 100,001/(number of measurement parameters)
- Sampling mode: linear or log

## Transient Response

The N1267A has the transient response as shown in [Figure 3-23](#) due to the internal circuit of HVSMU. After the N1267A switch status is changed from OFF to ON, HVSMU current is limited by the internal circuit, and voltage goes down. Finally it causes the current shift of *Current limit change* after *Current limit period* elapsed.

Figure 3-23

**Transient Response**

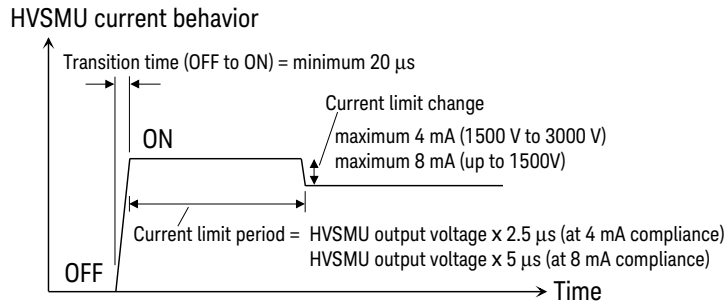

**I-V Characteristics of N1267A**

The N1267A has the I-V characteristics due to the internal semiconductor switches shown in Figure 3-21. When the device ON state characteristics is monitored, the voltage actually applied to the DUT will be the HCSMU setting voltage minus the voltage drop shown below. The voltage drop value varies by the current.

Figure 3-24

**HCSMU Output Current vs Voltage Drop**

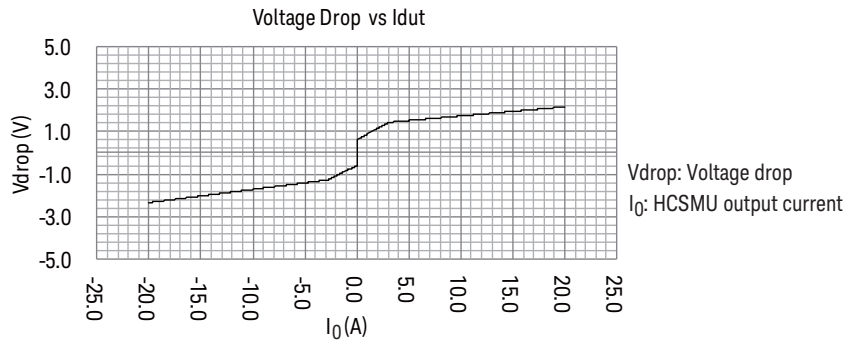

Table 3-18

**Voltage Drop**

Transistor measurement		Diode measurement	
Voltage drop	Current $I_0^a$	Voltage drop	Current $I_0^a$
$20 \times I_0$	$ I_0  \leq 30 \text{ mA}$	$58 \times I_0$	$ I_0  \leq 10 \text{ mA}$
$0.6 + 0.27 \times I_0$	$30 \text{ mA} <  I_0  \leq 3 \text{ A}$	$0.6 + 0.24 \times I_0$	$10 \text{ mA} <  I_0  \leq 3 \text{ A}$
$1.3 + 0.043 \times I_0$	$3 \text{ A} <  I_0  \leq 20 \text{ A}$	$1.1 + 0.062 \times I_0$	$3 \text{ A} <  I_0  \leq 20 \text{ A}$

a.  $I_0$ : HCSMU output current (A)

## N1268A Ultra High Voltage Expander

Voltage expander to enable 10 kV output and measurement. The N1268A is used to configure the ultra high voltage unit (UHVU) with two MC/HCSMU modules as shown in [Figure 3-25](#).

---

### WARNING



**Do not put anything on the N1268A Ultra High Voltage Expander.**

**Ne rien placer sur le N1268A Ultra High Voltage Expander.**

---

### WARNING



**Connect a wire from an electrical ground (safety ground) to the earth terminal.**

**Connectez un fil depuis une mise à la terre électrique (mise à la terre de sécurité) à la borne de terre.**

---

### WARNING



**Before touching the DUT after the ultra high voltage measurement using the UHVU, confirm that it has been discharged enough. For that, use right hand, ground and discharge the terminals over 10 seconds after stopping the high voltage output, and confirm that they have been safety voltage by using another volt meter.**

**Especially, it is dangerous if a capacitive load or a long cable is connected. When a large load capacitance is connected, the terminals may not have been discharged until the safety voltage below  $\pm 42$  V.**

**Avant de toucher le MST après la mesure de la tension ultra élevée avec l'UHVU, confirmez qu'il a été suffisamment déchargé. Pour cela, avec la main droite, mettez à la terre et déchargez les bornes plus de 10 secondes après l'arrêt de la tension de sortie élevée et confirmez que la tension est sécurisée en utilisant un autre voltmètre.**

**En particulier, cela peut être dangereux si une charge capacitive ou un câble long est connecté(e). Lorsqu'une grande capacité de charge est connectée, les bornes peuvent ne pas avoir été déchargées jusqu'à ce que la tension de sécurité soit en dessous de  $\pm 42$  V.**

---



- Earth terminal  
Screw terminal for earthing.
  - LINE input receptacle  
AC power cable is connected to this receptacle.
  - POWER indicator  
This green LED lights when the N1268A is turned on.
-

- Power switch

Turns on/off the N1268A.



- High Voltage Enable switch

Enables/disables high voltage output. This red switch lights when the N1268A is in the high voltage output enable status.

If the Power switch is set to the on position while this switch is in the on position, the high voltage output is not enabled. Then press this switch to set it to the off position, and press the switch again to enable the high voltage output.

---

**WARNING**



**The red light indicates that hazardous voltage (maximum  $\pm 10$  kVdc) may appear at the High terminal.**

**Le témoin rouge indique qu'une tension dangereuse (maximum  $\pm 10$  kV CC) risque d'apparaître au niveau de la borne High.**



- Interlock Input and Output

Interlock connector. Input connector is for connecting 16493J interlock cable from B1505A. And Output connector is for connecting 16493J interlock cable from test fixture, prober station, and such.

---

**WARNING**



**Potentially hazardous voltage may be present at the High terminal when the interlock terminals are shorted on test fixture, prober station, and such.**

**Une tension potentiellement dangereuse peut être présente à la borne High lorsque les bornes de verrouillage sont court-circuitées sur l'équipement de test, la station de sonde et autres.**

- Digital I/O connector

For connecting 16493G cable from the Digital I/O connector of B1505A, N1265A test fixture, or N1266A current expander.

- MCSMU/HCSMU V Control Force and Sense

Triaxial connectors. For connecting 16494A triaxial cables from Force and Sense connectors of the MCSMU. HCSMU is substitutable. Then use 16493S HCSMU cable, N1254A-103 adapter for Force, and N1254A-517 adapter for Sense.

- MCSMU I Control Force and Sense

Triaxial connectors. For connecting 16494A triaxial cables from Force and Sense connectors of the MCSMU. HCSMU is *NOT* substitutable.

- Output Low

SHV(jack) connector. Use SHV(plug)-SHV(plug) cable of 16493V to connect N1265A test fixture.

To connect prober, use N1269A adapter and SHV(plug)-SHV(plug) cable of 16493V. See “N1269A Ultra High Voltage Connection Adapter” on page 3-70 for connecting a prober.



- Output High

UHV(jack) connector. Use UHV(plug)-UHV(plug) cable of 16493V to connect N1265A test fixture.

To connect prober, use ultra high voltage cable with UHV(plug) connector, manipulator, and such.

**CAUTION**

Never connect the UHVU High terminal to any output, including circuit common, chassis ground, or any other measurement resource such as SMU. Connecting other measurement resource may damage the connected one.

**Figure 3-25**

**To Configure UHVU**

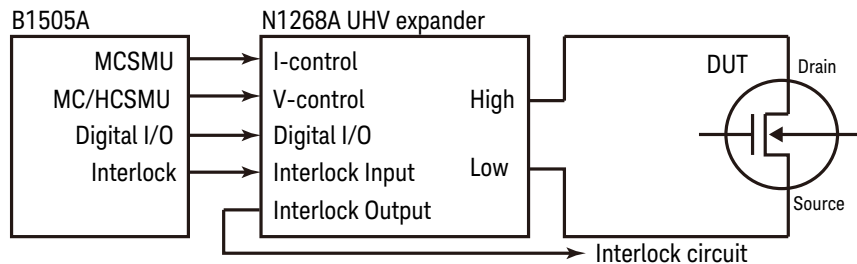

**NOTE**

For the gate terminal of DUT, use MCSMU. Another module cannot be used.

## N1269A Ultra High Voltage Connection Adapter

The N1269A is used to connect the N1268A UHV expander and the MCSMU modules to DUT. See [Figure 3-26](#) for connection example. Protection adapters for MCSMU are initially installed. The N1269A is used with a DUT interface such as your own test fixture and prober station, not the N1265A.

**Figure 3-26**

### To Use N1269A Adapter

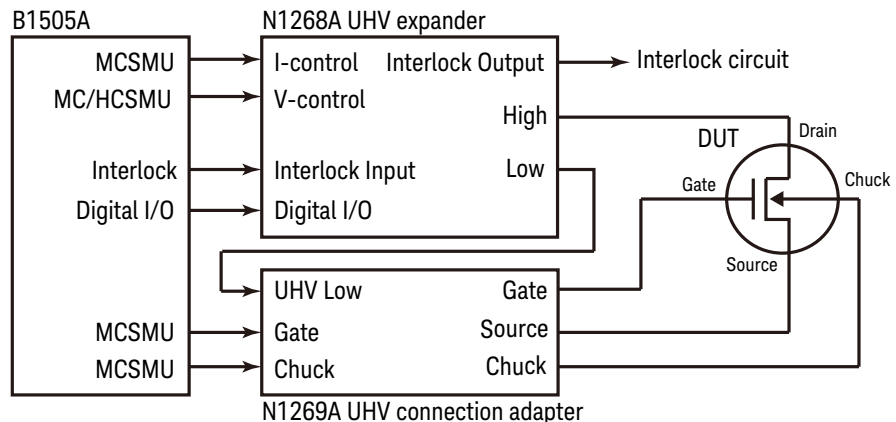

- UHV Low  
SHV(jack) connector. Use SHV(plug)-SHV(plug) cable of 16493V to connect the Low terminal of the N1268A UHV expander.
- Gate MCSMU Force and Sense  
Triaxial connectors. For connecting 16494A triaxial cables from Force and Sense connectors of the MCSMU. HCSMU is *NOT* substitutable.
- Chuck MCSMU Force and Sense  
Triaxial connectors. For connecting 16494A triaxial cables from Force and Sense connectors of the MCSMU. HCSMU is *NOT* substitutable.
- Gate, Source, Chuck  
SHV(jack) connectors. To connect prober, use cables with SHV(plug) connector, manipulators, and such.

## **N1271A Thermal Test Enclosure**

### **N1271A-001 Thermal Plate Compatible Enclosure for N1259A/N1265A**

The N1271A-001 is an option to enable thermal testing on N1259A/N1265A fixtures with inTEST Thermal Plate. For the Thermal Plate, contact inTEST Corporation.

This option includes the following components:

- Base plate

A plate to place the Thermal Plate. Remove the socket module from the test fixture and set the base plate instead.
- Thermal test hood

A heat-resistant hood adapted with the interlock. Use this instead of the fixture cover. Setting the hood properly releases the interlock and enables the high voltage output up to the maximum value.

The hood has two magnets on the back of its front panel, for fixing it on the fixture. Before setting the hood on the fixture, attach the protective film (furnished) on the surface of the magnet.
- Thermal plate adapter

An adapter to connect the thermal controller cable to the Thermal Plate cable.
- Test leads and connection kit for thermal test (N1254A-557)
  - Six 20 cm small alligator clip - lug cables, six banana plugs, six nuts, and six spare clips
  - Two 20 cm large alligator clip - lug cables, two banana plugs, and two nuts
  - Four 30 cm small alligator clip - lug cables, four banana plugs, four nuts, and four spare clips
  - Two 30 cm large alligator clip - lug cables, two banana plugs, and two nuts

For the setup image, see the following figure.

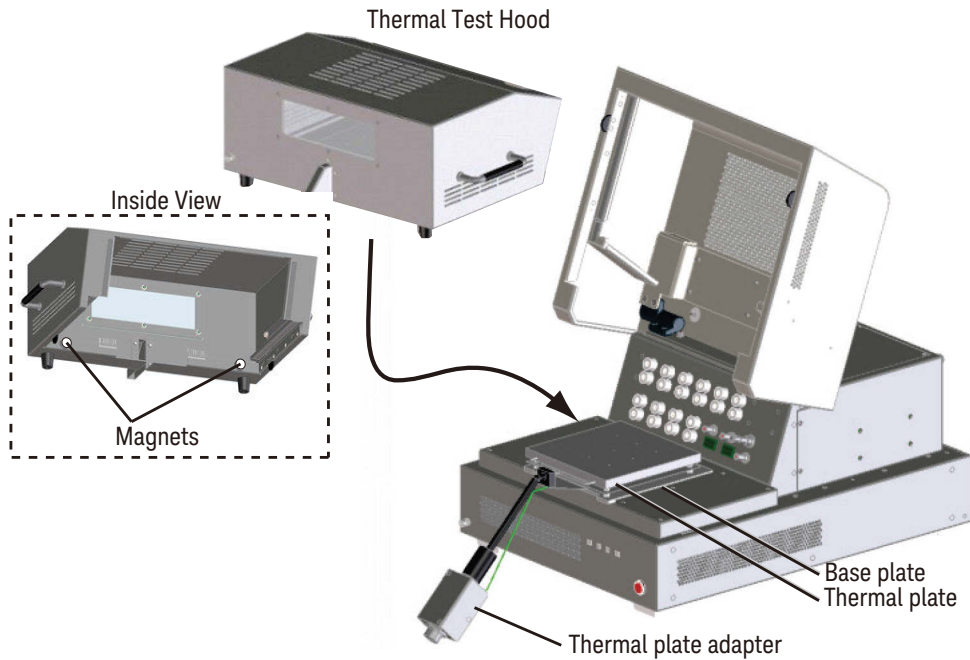

See the following simple instruction.

1. (First time only) Attach protective films (N1271-25015) on the surfaces of two magnets on the back of hood's front panel.
2. Remove the socket module from the test fixture and set the base plate on the DUT stage of the test fixture instead.
3. Place the Thermal Plate on the base plate.
4. Connect the cable from the Thermal Plate to the Thermal plate adapter.
5. Connect the ground wire from the Thermal plate adapter to the ground terminal on the base plate.
6. Put your DUT on the Thermal Plate.
7. Connect your DUT properly. Then use the test leads furnished with this option.
8. (for N1265A) If you use the thermocouple, do the following.
  - a. Connect the thermocouple to the K Thermocouple terminal.
  - b. Secure the end of the thermocouple to the place for monitoring temperature.



9. Connect the cable from the temperature controller to the Thermo plate adapter.
10. Set the hood on the test fixture, instead of the fixture cover.
11. Leave the fixture cover open and perform measurement.

**WARNING**

**Hazardous voltage, instrument maximum output voltage may appear at the measurement terminals if the hood or fixture cover is closed.**

**Une tension dangereuse, une tension de sortie maximale de l'appareil peut apparaître aux bornes de mesure si le capot ou couvercle de l'équipement est fermé.**

**WARNING**

**Make sure that the hood is closed properly before starting measurement. Do not perform the measurement when a wire is protruding from the hood.**

**Assurez-vous que le capot est fermé correctement avant de commencer la mesure. Ne pas effectuer la mesure lorsqu'un câble dépasse du capot de l'appareil.**

### **N1271A-002 Thermostream Compatible Enclosure for N1265A (3kV IV)**

The N1271A-002 is an enclosure to enable thermal testing (-50 °C to +220 °C) by creating an interface between the N1265A and an inTEST Thermostream. For the Thermostream, contact inTEST Corporation.

This option includes the following components:

- Adapter
 

Adapter for connecting the enclosure to the test fixture. The output terminals except for BiasTee, K Thermocouple, and UHV are connected to the enclosure.
- Pedestal
 

This supports the enclosure.
- Enclosure
 

A heat-resistant enclosure adapted with the interlock. Use this instead of the fixture cover. The enclosure cover on the top surface is the docking interface with the Thermostream.
- Test leads and connection kit for thermal test (N1254A-557)
  - Six 20 cm small alligator clip - lug cables, six banana plugs, six nuts, and six spare clips

## Accessories

- Two 20 cm large alligator clip - lug cables, two banana plugs, and two nuts
- Four 30 cm small alligator clip - lug cables, four banana plugs, four nuts, and four spare clips
- Two 30 cm large alligator clip - lug cables, two banana plugs, and two nuts

For the setup image, see the following figure.

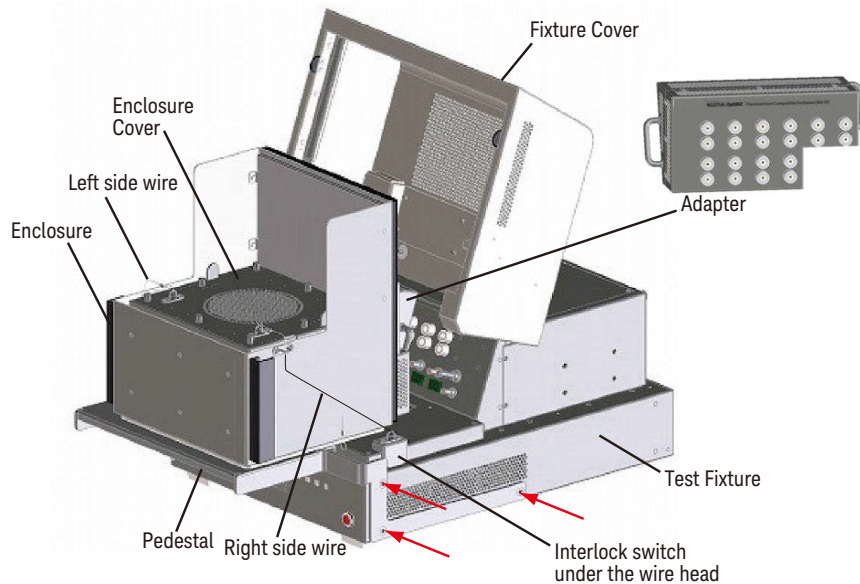

See the following simple instruction.

1. Remove the socket module from the test fixture.
2. Install the pedestal. The N1265A fixture has three screw holes on the both sides respectively. And, the brackets of the pedestal have the screw holes. Secure the pedestal to the fixture using the dedicated screws supplied with this option.

---

### WARNING



**For safety, firmly secure the pedestal.  
Do not place other than those specified on the pedestal.**

**Pour des raisons de sécurité, attacher solidement le piédestal.  
Ne rien placer d'autre que ce qui est spécifié sur le piédestal.**

3. If you use the thermocouple, connect the thermocouple to the K Thermocouple terminal.
4. Face the terminals on the adapter rear panel to the fixture output terminals, and

firmly connect them until no gap is shown between them.

5. Face the terminals on the enclosure rear panel to the adapter terminals, and firmly connect them until no gap is shown between them.
6. Unscrew and remove the enclosure cover.
7. Put your DUT in the enclosure. The device size should be smaller than approximately 260 mm (W) × 180 mm (D) × 120 mm (H).
8. Connect your DUT properly. Then use the test leads furnished with this option. See **Figure 3-27** for the assignment of the terminals inside the enclosure.

Do not leave the unused test leads inside the enclosure.

9. If you use the thermocouple, secure the end of the thermocouple to the place for monitoring temperature.
10. Set and fix the enclosure cover by screws so that the openings are not made between the enclosure body and the cover especially around the slit labeled “Thermocouple”.

If you use the thermocouple, pass it through the slit. If two thermocouples are used, adjust them so that they do not overlap together.

11. Set the Thermostream on the enclosure cover.

Adjust the nozzle of the Thermostream so that it fits the cover horizontally and so that the openings are not made between them.

Connect the purge air tube from the Thermostream to the Purge air inlet at the enclosure side back.

12. Set the left side wire head in the slit of the test fixture interlock switch and ram it down.
13. Set the right side wire head in the slit of the test fixture interlock switch and ram it down.
14. Leave the fixture cover open and perform measurement.

---

**WARNING**

Activating the Thermostream may cause low or high temperature of  $-50\text{ }^{\circ}\text{C}$  to  $+220\text{ }^{\circ}\text{C}$  on the enclosure front panel, the cover, and the left and right protection panels. To prevent yourself from getting injured, confirm that they are in the safe temperature range before touching the enclosure.

L'activation du flux thermique peut entraîner une basse ou haute température de  $-50\text{ }^{\circ}\text{C}$  à  $+250\text{ }^{\circ}\text{C}$  sur le panneau de protection avant, le couvercle et les panneaux de protection à gauche et à droite. Pour éviter de vous blesser, confirmez qu'ils sont dans la plage de température de sécurité avant de toucher le boîtier.

---

---

**WARNING**

While the enclosure wire heads (To Slit) are rammed down into the slits of the test fixture interlock switches, hazardous voltage, instrument maximum output voltage may appear at the measurement terminals.

Pendant que les têtes de fil d'enceinte (à fente) sont enfoncés dans les fentes des commutateurs d'interverrouillage de mélange d'essai, une tension dangereuse, une tension de sortie maximale d'instrument peut apparaître aux bornes de mesure.

---

---

**CAUTION**

Do not expose the back of the enclosure to the condensation. Wetting the connection cables or connectors may cause instrument damage.

---

---

**WARNING**

**Purge air inlet**

**To prevent condensation, connect the Thermostream purge air tube here.**

**Purgez l'admission d'air**

**Pour empêcher toute formation de condensation, connectez le tube de purge d'air Thermostream ici.**

---

Figure 3-27

## N1271A-002 Terminal Assignment Example

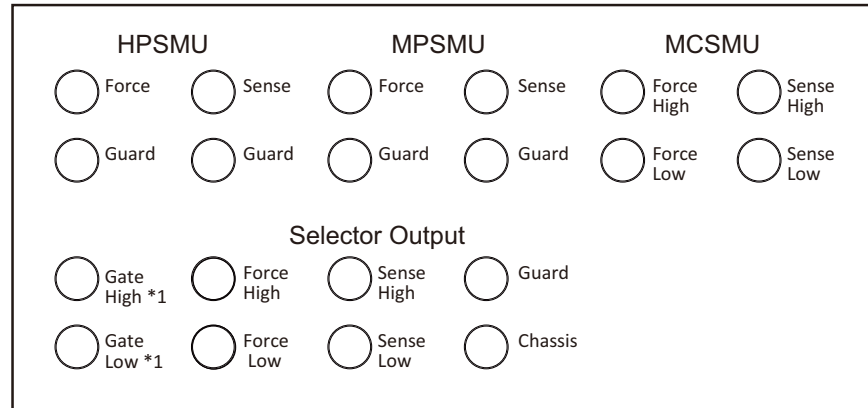

\*1 For connecting the DUT Gate terminal on the measurement using the Selector Output.

Figure 3-27 shows the example if a HPSMU, a MPSMU, and a MCSMU have been connected to the N1265A rear panel as follows.

- SMU [1] connector: HPSMU Force
- SMU [2] connector: HPSMU Sense
- SMU [3] connector: MPSMU Force
- SMU [4] connector: MPSMU Sense
- SMU [5] connector: MCSMU Force
- SMU [6] connector: MCSMU Sense

### **N1271A-005 Thermostream Compatible Enclosure for N1265A (3kV IV, CV & 10kV)**

The N1271A-005 is an enclosure to enable thermal testing by creating an interface between the N1265A and an inTEST Thermostream. The enclosure supports fully automated IV and CV measurements up to 3 kV, and IV measurements up to 10 kV at temperature ranging from -50 °C to +220 °C. For the Thermostream, contact inTEST Corporation.

This option includes the following components:

- Adapter

Adapter for connecting the enclosure to the test fixture. The output terminals except for BiasTee, K Thermocouple, and UHV are connected to the enclosure.

- Pedestal

This supports the enclosure.

- Enclosure

A heat-resistant enclosure adapted with the interlock. Use this instead of the fixture cover. The enclosure cover on the top surface is the docking interface with the Thermostream.

The enclosure has cables for extending the Bias Tee High and Low terminals and the UHV High and Low terminals. The ends of them in the enclosure have M4 lug terminals for connecting DUT. You can change the lug terminals to other size or type terminals if necessary. If you do not use them, clamp the cables in the enclosure using clips.

- Test leads and connection kit for thermal test (N1254A-557)
  - Six 20 cm small alligator clip - lug cables, six banana plugs, six nuts, and six spare clips
  - Two 20 cm large alligator clip - lug cables, two banana plugs, and two nuts
  - Four 30 cm small alligator clip - lug cables, four banana plugs, four nuts, and four spare clips
  - Two 30 cm large alligator clip - lug cables, two banana plugs, and two nuts

For the setup image, see the following figure.

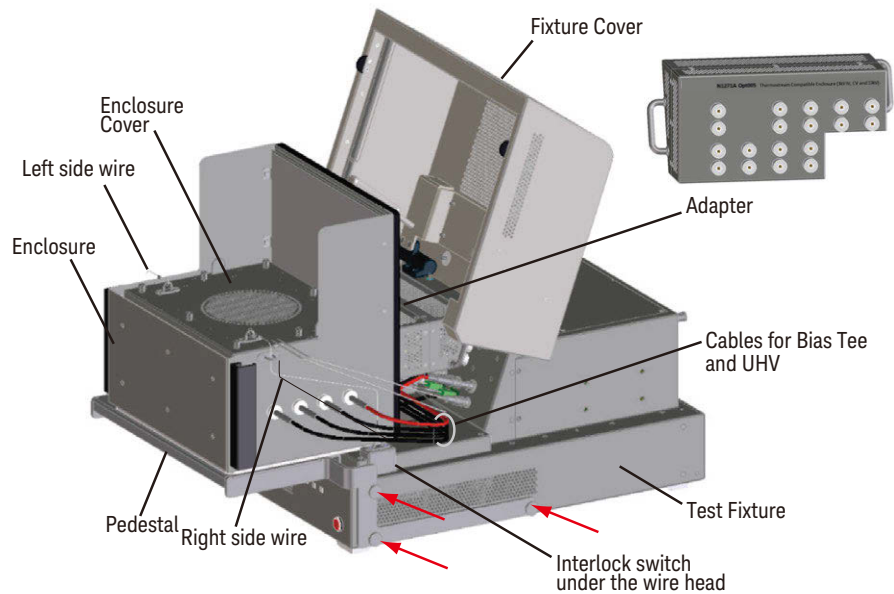

See the following simple instruction.

1. Remove the socket module from the test fixture.
2. Install the pedestal. The N1265A fixture has three screw holes on the both sides respectively. And, the brackets of the pedestal have the screw holes. Secure the pedestal to the fixture using the dedicated screws supplied with this option.

---

**WARNING**



**For safety, firmly secure the pedestal.  
Do not place other than those specified on the pedestal.**

**Pour des raisons de sécurité, attacher solidement le piédestal.  
Ne rien placer d'autre que ce qui est spécifié sur le piédestal.**

3. If you use the thermocouple, connect the thermocouple to the K Thermocouple terminal.
4. Put the enclosure on the pedestal and connect the following cables to the associated terminals on the fixture properly.
  - Bias Tee High cable
  - Bias Tee Low cable
  - UHV High cable

- UHV Low cable
5. Face the terminals on the adapter rear panel to the fixture output terminals, and firmly connect them until no gap is shown between them.
  6. Face the terminals on the enclosure rear panel to the adapter terminals, and firmly connect them until no gap is shown between them.
  7. Unscrew and remove the enclosure cover.
  8. Put your DUT in the enclosure. The device size should be smaller than approximately 260 mm (W) × 180 mm (D) × 120 mm (H).
  9. Connect your DUT properly. Then use the test leads furnished with this option or the extension cables connected to the Bias Tee terminals or the UHV terminals. See [Figure 3-28](#) for the assignment of the terminals inside the enclosure.

Do not leave the unused test leads inside the enclosure. Bundle and secure the unused cables using clips inside the enclosure.

10. If you use the thermocouple, secure the end of the thermocouple to the place for monitoring temperature.
11. Set and fix the enclosure cover by screws so that the openings are not made between the enclosure body and the cover especially around the slit labeled “Thermocouple”.

If you use the thermocouple, pass it through the slit. If two thermocouples are used, adjust them so that they do not overlap together.

12. Set the Thermostream on the enclosure cover.

Adjust the nozzle of the Thermostream so that it fits the cover horizontally and so that the openings are not made between them.

Connect the purge air tube from the Thermostream to the Purge air inlet at the enclosure side back.

13. Set the left side wire head in the slit of the test fixture interlock switch and ram it down.
14. Set the right side wire head in the slit of the test fixture interlock switch and ram it down.
15. Leave the fixture cover open and perform measurement.



---

**WARNING**

Activating the Thermostream may cause low or high temperature of  $-50\text{ }^{\circ}\text{C}$  to  $+220\text{ }^{\circ}\text{C}$  on the enclosure front panel, the cover, and the left and right protection panels. To prevent yourself from getting injured, confirm that they are in the safe temperature range before touching the enclosure.

L'activation du flux thermique peut entraîner une basse ou haute température de  $-50\text{ }^{\circ}\text{C}$  à  $+250\text{ }^{\circ}\text{C}$  sur le panneau de protection avant, le couvercle et les panneaux de protection à gauche et à droite. Pour éviter de vous blesser, confirmez qu'ils sont dans la plage de température de sécurité avant de toucher le boîtier.

---

**WARNING**

While the enclosure wire heads (To Slit) are rammed down into the slits of the test fixture interlock switches, hazardous voltage, instrument maximum output voltage may appear at the measurement terminals.

Pendant que les têtes de fil d'enceinte (à fente) sont enfoncés dans les fentes des commutateurs d'interverrouillage de mélange d'essai, une tension dangereuse, une tension de sortie maximale d'instrument peut apparaître aux bornes de mesure.

---

**CAUTION**

Do not expose the back of the enclosure to the condensation. Wetting the connection cables or connectors may cause instrument damage.

---

**WARNING**

**Purge air inlet**

**To prevent condensation, connect the Thermostream purge air tube here.**

**Purgez l'admission d'air**

**Pour empêcher toute formation de condensation, connectez le tube de purge d'air Thermostream ici.**

---

**CAUTION**

SMU 1 path has been designed for the Gate connection on the ultra high voltage measurement using the UHVU. Do not use this path for the other purpose. Also do not use the other path for this purpose. The only SMU 1 path has the built-in protection adapter for preventing the connected SMU from damage. Using the other path may damage the connected SMU.

SMU 1 input on the N1265A rear panel must be connected to a MCSMU as shown below.

- SMU [1] connector: MCSMU Force
- SMU [2] connector: MCSMU Sense

For connecting DUT, the SMU 1 and the UHV must be connected as shown below.

- SMU 1 High terminal: Gate High
- SMU 1 Low terminal: Gate Low
- UHV High cable: Drain
- UHV Low cable: Source

**Figure 3-28**

**N1271A-005 Terminal Assignment Example**

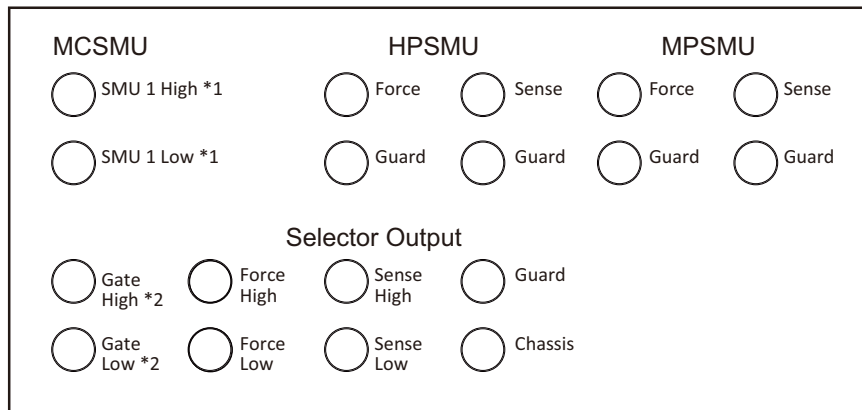

\*1 For connecting the DUT Gate terminal on the ultra high voltage measurement using the UHVU.

\*2 For connecting the DUT Gate terminal on the measurement using the Selector Output.

Figure 3-28 shows the example if a MCSMU, a HPSMU, and a MPSMU have been connected to the N1265A rear panel as follows.

- SMU [1] connector: MCSMU Force
- SMU [2] connector: MCSMU Sense
- SMU [3] connector: HPSMU Force
- SMU [4] connector: HPSMU Sense
- SMU [5] connector: MPSMU Force
- SMU [6] connector: MPSMU Sense

## N1272A Device Capacitance Selector

The N1272A is used to switch the measurement resource connected to the device under test (DUT), for capacitance testing (input/output capacitance, feedback capacitance, and gate resistance). The measurement resource will be HVSMU, MPSMU and MFCMU.

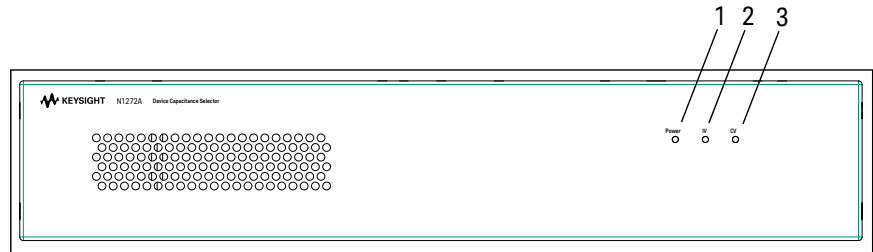
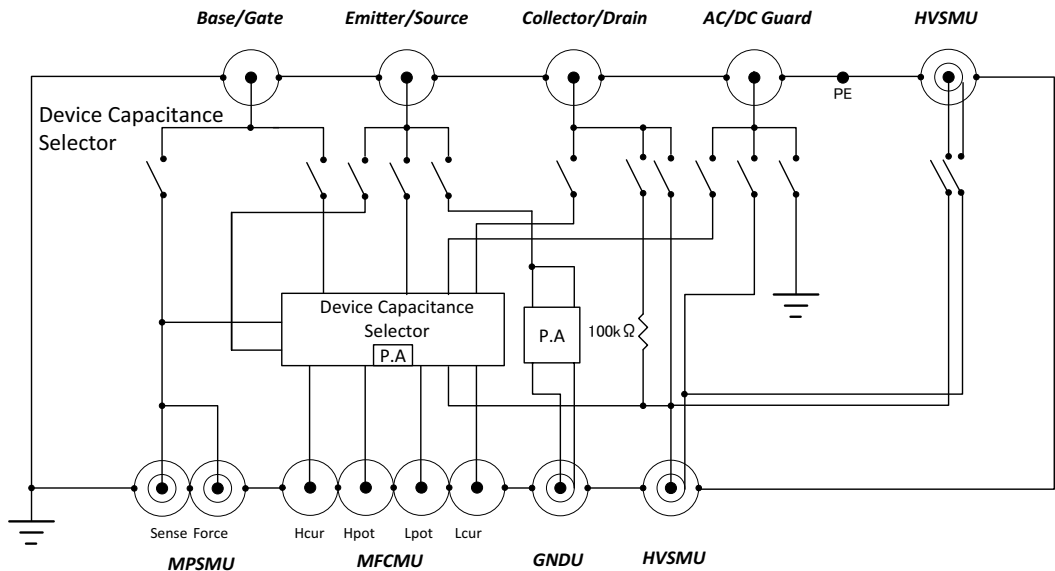

Figure 3-29

### Selector Simplified Internal Connections



**NOTE**

Selector input-to-output internal connection is controlled by the application test automatically.

Also, it can be controlled directly by using the Direct Control classic test. See Keysight B1500 *Programming Guide* for the control commands.

## Front Panel

### 1. Power indicator

This LED turns orange when AC power is applied to the selector.

This LED turns green when the selector is ready to use.

### 2. IV indicator

A green LED lights to indicate when the present connection path of the selector is in I-V measurement mode.

### 3. CV indicator

A green LED lights to indicate when the present connection path of the selector is in C-V measurement mode.

## Rear Panel

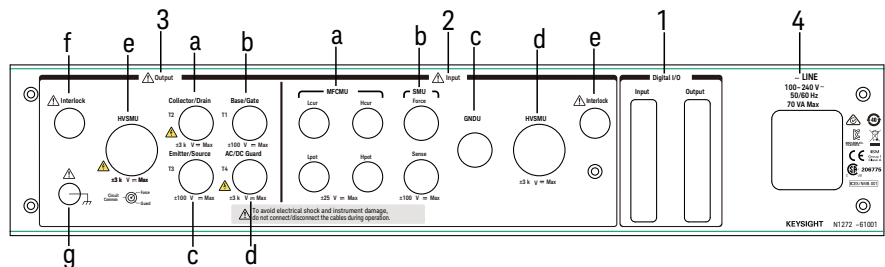

### 1. Digital I/O connectors

Input connector: For connecting the furnished Digital I/O cable (B1506-61780) from the Digital I/O connector of B1505A. If the selector is used with other fixture or selector, you can also connect the output from it to this input connector.

Output connector: For connecting the 16493G cable from the Digital I/O input connector of the used other fixture or selector. This supports N1258A, N1259A-300, and N1265A.

## CAUTION

Connect 16493G cables after turning the instruments off. Connection and disconnection while the instruments are on may cause instrument damage.



### 2. Input

a. MFCMU input connectors Hcur, Hpot, Lpot, and Lcur

BNC connectors. For connecting the N1300A-001 cable (1.5 m) from the MFCMU.

b. SMU input connectors

Force and Sense triaxial connectors. For connecting the 16494A triaxial cable from the MPSMU.

c. GNDU input connector

GNDU triaxial connector. For connecting the 16493L GNDU cable from the GNDU.

For the measurement using the N1258A selector or the N1259A/N1265A fixture, open this terminal. The GNDU must be connected to the used one.

d. HVSMU input connector

HV(jack) connector. For connecting the 16493T HVSMU cable from the HVSMU.



e. Interlock input connector

Interlock connector. For connecting the 16493J interlock cable from B1505A.

For the measurement using the N1259A/N1265A fixture, open this terminal. The B1505A Interlock must be connected to the used one.



3. Output

a. Collector/Drain output connector

SHV(jack) connector. If the N1273A fixture is used, connect the composite cable (B1507-61720) from the Collector/Drain input connector of the N1273A.

For connecting a prober station, use the SHV cable, manipulator, and such.

b. Base/Gate output connector

SHV(jack) connector. If the N1273A fixture is used, connect the composite cable (B1507-61720) from the Base/Gate input connector of the N1273A.

For connecting a prober station, use the SHV cable, manipulator, and such.

c. Emitter/Source output connector

SHV(jack) connector. If the N1273A fixture is used, connect the composite cable (B1507-61720) from the Emitter/Source input connector of the N1273A.

For connecting a prober station, use the SHV cable, manipulator, and such.

d. AC/DC Guard output connector

SHV(jack) connector. If the N1273A fixture is used, connect the composite cable (B1507-61720) from the AC/DC Guard input connector of the N1273A.

For connecting a prober station, use the SHV cable, manipulator, and such.

e. HVSMU output connector

HV(jack) connector. Connect the 16493T HVSMU cable from the HVSMU input connector of the used accessory, the N1258A selector or the N1259A/N1265A fixture. You do not need to switch the connection between I-V and C-V measurements if you use this connector.



f. Interlock output connector

Interlock connector. If the N1273A fixture is used, connect the composite cable (B1507-61720) from the Interlock connector of the N1273A.

For connecting a prober station, connect the 16493J interlock cable from the interlock circuit of the prober station.



g. Frame ground terminal

If the N1273A fixture is used, connect the composite cable (B1507-61720) from the frame ground terminal of the N1273A.

4. LINE input receptacle and power switch

The AC power cable is connected to this receptacle. The power switch turns on/off the N1272A.

---

**NOTE**

---

To prevent the occurrence of forgetting to turn on the selector, it is recommended to turn the selector on before turning on the B1505A mainframe.

---

**NOTE**

---

The selector may emit a noise sound during operation. However, this is not an abnormal status.

## N1273A Capacitance Test Fixture

The N1273A is used to enable packaged device capacitance testing (input/output capacitance, feedback capacitance, and gate resistance) in conjunction with the N1272A Device Capacitance Selector.

---

**WARNING**

If the N1273A is used with the N1259A or the N1265A fixture, you need to change the connection of the interlock and GNDU cables each time you change the fixture.

For safety, check the interlock function after changing the connection. To verify the interlock function, perform the Interlock Open/Close test on the Main Frame tab screen of the EasyEXPERT Configuration window.

Si le N1273A est utilisé avec l'équipement N1259A ou N1265A, vous devez changer la connexion du verrouillage et des câbles GNDU à chaque fois que vous changez l'équipement.

Pour des raisons de sécurité, vérifier la fonction de verrouillage après le changement de connexion. Pour vérifier la fonction de verrouillage, effectuer l'Interlock Open/Close test sur l'écran de l'onglet Main Frame de la fenêtre EasyEXPERT Configuration.

---

### Front Panel



 1. Hazardous voltage status indicator

This red LED lights when a source channel applies dangerous voltage. This indicator is connected to the B1505A via the Interlock connector and works with the High Voltage indicator on the B1505A's front panel.

Warning labels written in French, German, and Japanese are furnished. Attach the label to the front panel of the fixture if you need.

---

**WARNING**



**The red light indicates that hazardous voltage (maximum  $\pm 3000$  Vdc) may appear at measurement terminals. Check this indicator before accessing.**

**Le témoin rouge indique qu'une tension dangereuse (maximum  $\pm 3000$  V CC) risque d'apparaître au niveau des bornes de mesure. Vérifiez cet indicateur avant d'accéder.**

---

2. Terminal for connecting wrist strap

3. Fixture cover

The fixture cover should be closed to avoid electrical shock by touching the measurement terminals and to prevent a device under test from external noise.

When the fixture cover is open, maximum SMU output is limited to  $\pm 42$  V.

---

**WARNING**



**Hazardous voltage, instrument maximum output voltage may appear at the measurement terminals if the fixture cover is closed.**

**Une tension dangereuse, une tension de sortie maximale de l'appareil peut apparaître aux bornes de mesure si le couvercle de l'équipement est fermé.**

---

**WARNING**



**Make sure that the cover is closed properly before starting measurement. Do not perform the measurement when a wire is protruding from the fixture cover.**

**Assurez-vous que le couvercle est fermé correctement avant de commencer la mesure. Ne pas effectuer la mesure lorsqu'un câble dépasse du couvercle de l'appareil.**

---



## Rear Panel

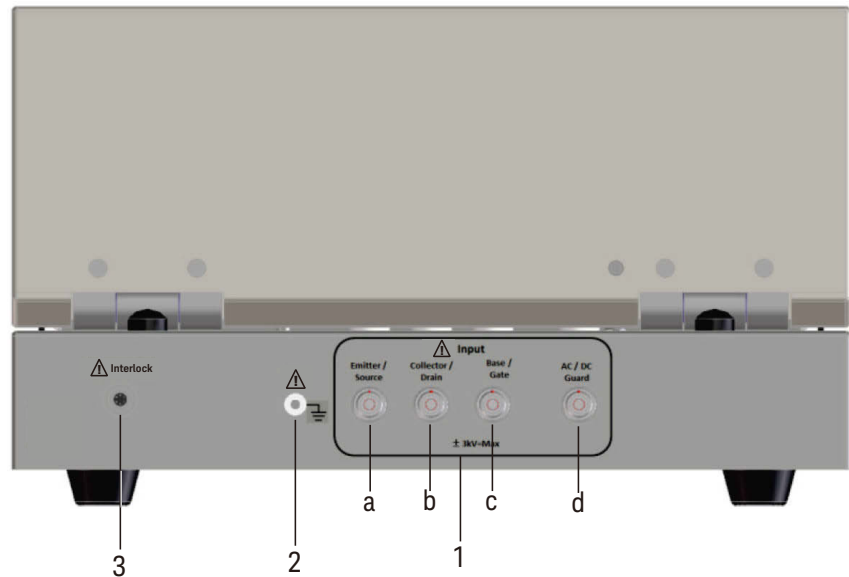

### 1. Input

- Emitter/Source input connector  
SHV(jack) connector. For connecting the composite cable (B1507-61720) from the Emitter/Source output connector of the N1272A selector. The composite cable is supplied with the N1273A.
- Collector/Drain input connector  
SHV(jack) connector. For connecting the composite cable (B1507-61720) from the Collector/Drain output connector of the N1272A selector. The composite cable is supplied with the N1273A.
- Base/Gate input connector  
SHV(jack) connector. For connecting the composite cable (B1507-61720) from the Base/Gate output connector of the N1272A selector. The composite cable is supplied with the N1273A.

- AC/DC Guard input connector

SHV(jack) connector. For connecting the composite cable (B1507-61720) from the AC/DC Guard output connector of the N1272A selector. The composite cable is supplied with the N1273A.

- ⚠ 2. Frame ground terminal

Screw terminal. For connecting the composite cable (B1507-61720) from the frame ground terminal of the N1272A. The composite cable is supplied with the N1273A.

- ⚠ 3. Interlock connector

Interlock connector. For connecting the composite cable (B1507-61720) from the Interlock output connector of the N1272A. The composite cable is supplied with the N1273A.

## ⚠ Output Terminal Panel

---

### WARNING



Set the instrument output off before connecting or disconnecting connection wire.

**Press the B1505A front panel Stop key to set the module output off. And confirm that the B1505A front panel High Voltage indicator is not lit.**

**Désactivez la sortie de l'appareil avant de brancher ou de débrancher un câble de connexion.**

**Appuyez sur la touche Stop du panneau avant du B1505A pour désactiver la sortie. Et confirmez que l'indicateur de tension High du panneau avant du B1505A n'est pas allumé.**

---

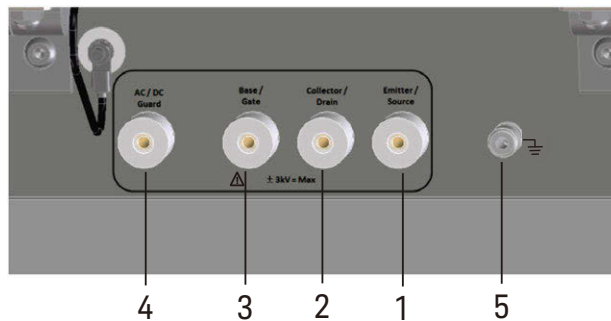

1. Emitter/Source terminal  
Connect to the Emitter/Source terminal of the DUT.
2. Collector/Drain terminal  
Connect to the Collector/Drain terminal of the DUT.
3. Base/Gate terminal  
Connect to the Base/Gate terminal of the DUT.
4. AC/DC Guard terminal  
This works as AC guard when the CV indicator on the N1272A selector lights.  
This works as DC guard when the IV indicator lights.  
Generally, open this terminal for safety.
5. Chassis common terminal  
Use for grounding or shielding.  
  
If 3-pin inline package socket module is used, connect the earthing wire connected to the socket module.

### Socket Modules

---

#### **WARNING**



**To prevent electrical shock and DUT damage, do not connect or disconnect the DUT while the instrument is applying voltage or current.**

**When you touch the DUT after measurement, devise a countermeasure of residual charge and heat to prevent electrical shock and burn. Use gloves and any tool. Also have enough time for discharge and radiation.**

**Afin d'éviter toute décharge électrique et dommage MST, ne branchez ou débranchez pas la sortie MST alors que l'appareil envoie de la tension ou du courant.**

**Lorsque vous touchez le MST après la mesure, élaborer une contre-mesure de la charge résiduelle et du chauffage afin d'éviter tout choc électrique et toute brûlure. Utilisez des gants et des outils. Prévoyez également du temps pour la décharge et la radiation.**

---



---

#### **WARNING**



**Hazardous voltage, instrument maximum output voltage may appear at the measurement terminals if the fixture cover is closed.**

**Une tension dangereuse, une tension de sortie maximale de l'appareil peut apparaître aux bornes de mesure si le couvercle de l'équipement est fermé.**



- 3-pin Inline Package Socket Module (supplied with the N1273A)

Use the socket module to connect a three-terminal inline packaged device.

**Figure 3-30 3-pin Inline Package Socket Module**



A short plate is furnished with the socket module. It is used for performing the short correction before the capacitance measurement. Set it on the socket before the short correction and remove it after the correction.

To use this module, see the following simple instruction.

1. If the earthing wire is not connected to the socket module, connect it.
2. Attach the socket module directly to the Base/Gate, Collector/Drain, and Emitter/Source terminals of the test fixture.
3. Connect the earthing wire of the socket module to the chassis common terminal.
4. Set your DUT on the socket.
5. Close the fixture cover and perform measurement.

---

**CAUTION**

Do not apply voltage/current over the maximum limit of the socket module.

Terminal rated voltage: 3000 Vdc

Terminal rated current: 120 mA

---

-  • Universal Socket Module (N1273A-011)  
 This is a blank module, kind of a do-it-yourself kit for supporting a variety of packaged devices. This module can be used by mounting your desired socket or packaged device.

**Figure 3-31 Universal Socket Module**

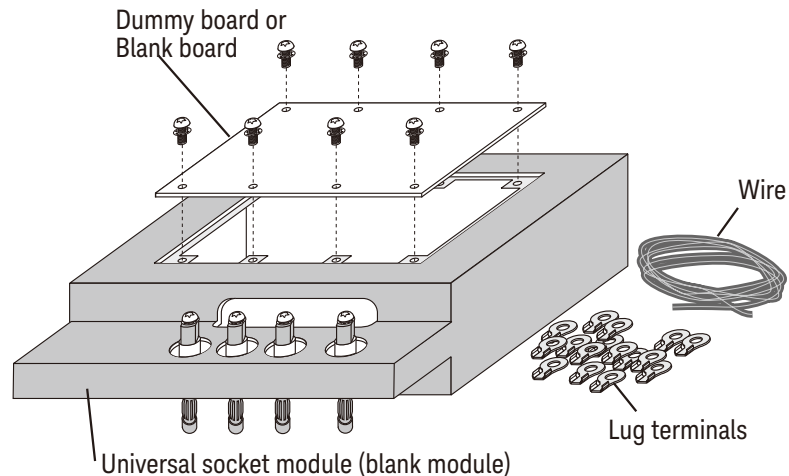

To use this module, see the following simple instruction. For the dimensions and screw holes of a blank board, see [Figure 3-32](#). You can use their handmade socket modules with the same manner as the 3-pin Inline Package Socket Module. See [“3-pin Inline Package Socket Module \(supplied with the N1273A\)”](#) on page 3-92.

- Prepare the following parts.
  - blank board suitable for mounting the socket or packaged device
  - screws for fixing the blank board, supplied with the socket module
  - wire (2 m, 1 ea.) supplied with the socket module
  - lug terminals (14 ea.) supplied with the socket module
  - socket, if you use, and packaged device under test (DUT)
  - T-10 and T-15 Torx screwdrivers
  - 9 mm wrench
  - caulking tool for lug terminals, 2.0sq

Prepare tools for mounting the socket, screws and nut for socket terminals, and so on separately.

**Figure 3-32 Dimensions and Screw Holes of Blank Board**

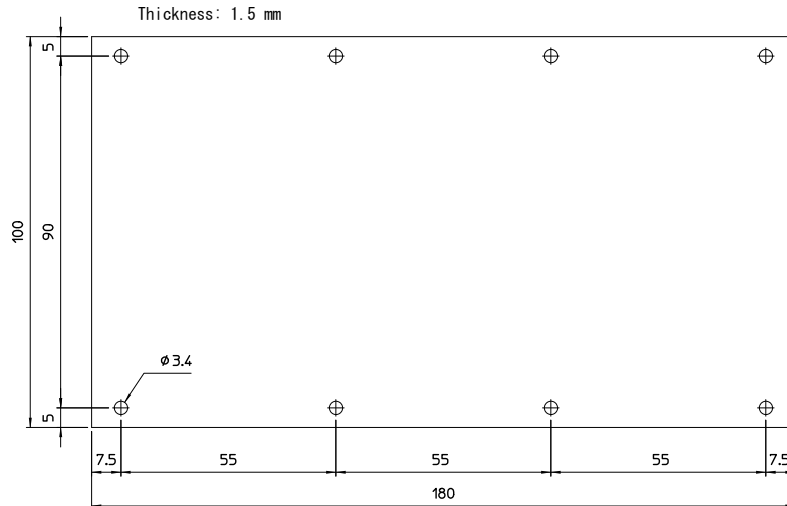

2. Remove the dummy board from the blank module using a T15 Torx screwdriver.
3. Make a socket board by processing a blank board or the dummy board and mount your device socket onto the board.

**WARNING**



**Make enough space between the socket terminal and the shield/chassis, for example, about 1 mm for maximum 200 V output and 6 mm for 3000 V, to prevent discharge and any accident.**

**Laissez suffisamment d'espace entre la prise borne et la protection/le châssis. Par exemple, environ 1 mm pour une sortie de 200 V au maximum et 6 mm pour 3 000 V afin d'éviter toute décharge et tout accident.**

4. Fix the socket board to the blank module using the screws and tooth washers you kept when removing the dummy board.
5. Remove the bottom cover of the blank module using a T10 Torx screwdriver.
6. Assemble cables using the wire and lug terminals.

Cut the appropriate length of the wire, tear off the coating of wire ends, and then secure the lug terminals to the wire ends using a caulking tool.

7. Connect one end of all cables to the inside terminals on the blank module.

Remove screws and tooth washers from the terminals, and fix the lug terminal of the cable end in order of a washer, a lug terminal, a tooth washer, and a screw. When fixing the lug terminal, secure a screw by a T15 Torx screwdriver with fixing the bottom nut by a 9 mm wrench.

The following shows the positions of the inside terminals in the blank module.

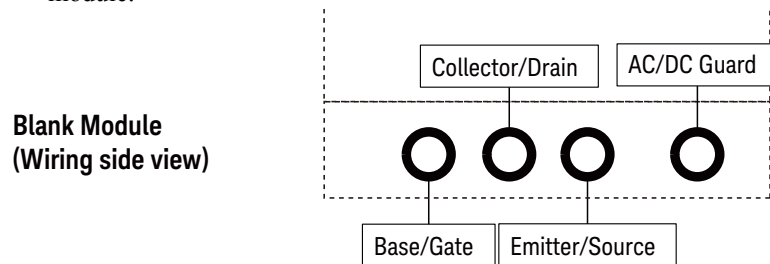

8. Connect the other end of the cables to the terminals on the back side of the socket board.

If a socket terminal does not have a screw or nut for securing a lug terminal of the cable, prepare it. Ensure the terminal position of the blank module and the socket board, and connect the cables correctly.

9. Fix the bottom cover to the blank module using a T10 Torx screwdriver.

---

### CAUTION

Do not apply voltage/current over the maximum limit of the socket module.  
Terminal rated voltage: 3000 Vdc  
Terminal rated current: 120 mA

---

- Curve Tracer Test Adapter Socket Module (N1273A-013)

This module provides a socket available for connecting a test adapter designed for connecting to Tektronix 370B/371B curve tracers. The socket module internal connection is shown in [Figure 3-33](#).

**Figure 3-33** Curve Tracer Test Adapter Socket Module

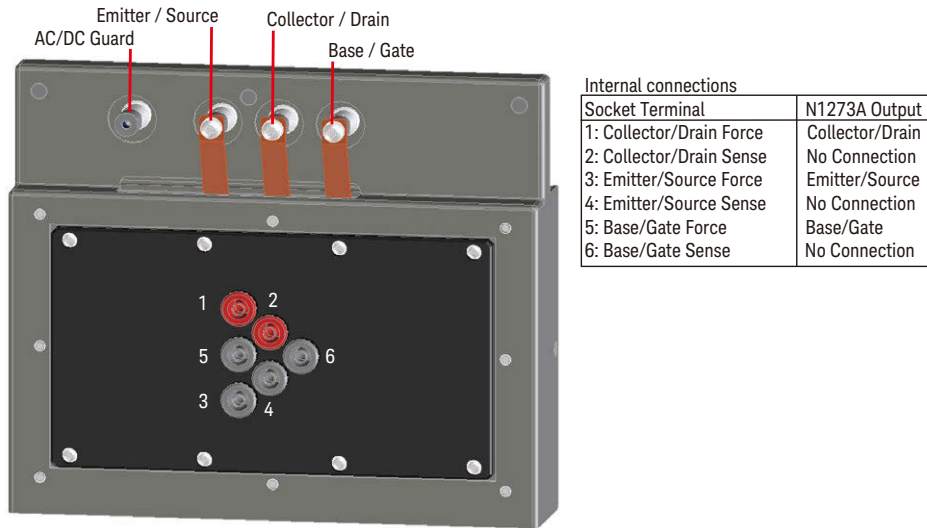

To use this module, see the following simple instruction.

1. Connect the socket module to the Base/Gate, Collector/Drain, and Emitter/Source connectors on the test fixture directly.
2. Connect your test adapter to the socket.
3. Set the DUT on your test adapter.
4. Close the fixture cover and perform measurement.

**CAUTION**

Do not apply voltage/current over the maximum limit of the socket module.  
Terminal related voltage: 3000 Vdc  
Terminal related current: 100 mA



## Other Accessories for connecting DUT

Use the test lead kit supplied with N1273A to connect a device that cannot be connected to any socket module.

To make connections, see the following simple instruction.

1. Prepare the following parts.
  - N1254A-556 Test Leads and Connection Kit for Capacitance Test, four 20 cm alligator clip - lug cables, four banana plugs, four nuts, and four spare clips
  - DUT
2. Put your DUT on the blank silicon plate.
3. Connect your DUT to the measurement terminals of the test fixture by using the test leads.
4. Close the fixture cover and perform measurement.

---

### WARNING



**Set the instrument output off before connecting or disconnecting connection wire.**

**Press the B1505A front panel Stop key to set the module output off. And confirm that the B1505A front panel High Voltage indicator is not lit.**

**Désactivez la sortie de l'appareil avant de brancher ou de débrancher un câble de connexion.**

**Appuyez sur la touche Stop du panneau avant du B1505A pour désactiver la sortie. Et confirmez que l'indicateur de tension High du panneau avant du B1505A n'est pas allumé.**

---

### WARNING



**Hazardous voltage, instrument maximum output voltage may appear at the measurement terminals if the fixture cover is closed.**

**Une tension dangereuse, une tension de sortie maximale de l'appareil peut apparaître aux bornes de mesure si le couvercle de l'équipement est fermé.**

---

### WARNING



**Open the AC/DC Guard terminal to avoid electrical shock, instrument damage, or DUT damage. Do not connect anything to this terminal which may have the same potential as the Collector/Drain terminal.**

**Ouvrez la borne AC/DC Guard pour éviter toute décharge électrique et tout endommagement de l'appareil ou du MST. Ne connectez rien à cette borne qui a le même potentiel que la borne Collector/Drain.**

---

**WARNING**



**Make sure that the cover is closed properly before starting measurement. Do not perform the measurement when a wire is protruding from the fixture cover.**

**Assurez-vous que le couvercle est fermé correctement avant de commencer la mesure. Ne pas effectuer la mesure lorsqu'un câble dépasse du couvercle de l'appareil.**

---

## N1274A On-Wafer Gate Charge Measurement Adapter/Selector for 20 A/3 kV

The N1274A is an adapter to enable on-wafer gate charge measurements using the HCSMU (max. 20 A) and HVSMU (max. 3 kV). This equips an internal selector to automatically switch signal paths of I-V measurement and gate charge measurement. The N1274A is used with the N1258A module selector.

To perform the gate charge measurement, a current control device or a load resistor must be mounted on this adapter.

The current control device must be a 3-pin inline package device which is expected to have the same characteristics as DUT. If the device is not available, use a load resistor. The resistor must satisfy the following specifications.

Resistance =  $V_r/I_r$  ( $V_r$ : rated voltage,  $I_r$ : rated current)

Peak power  $\geq V_r \times I_r \times 1$  ms

### WARNING



Install the N1274A in the shielding box equipped with the interlock circuit.

Installer le N1274A dans la boîte de protection équipée d'un circuit de verrouillage.

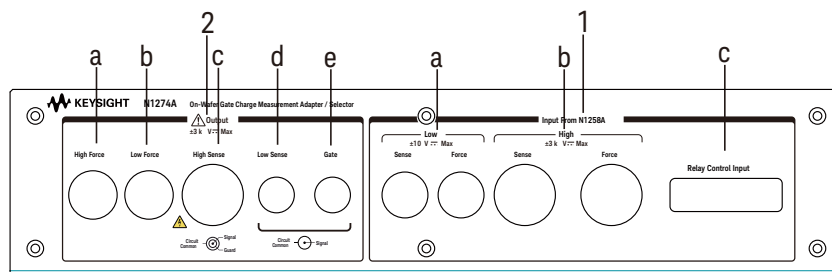

### Front Panel

1. Input from N1258A
  - a. Low Force and Sense input connectors

BNC connectors. For connecting two BNC cables (B1512-61741) from the Low Force and Sense connectors of the N1258A. These BNC cables are supplied with the N1274A.

b. High Force and Sense input connectors

HV(jack) connectors. For connecting a HV coaxial cable (N1274-61721) from the High Force connector of the N1258A, and HV triaxial cable (N1274-61720) from the High Sense connector of the N1258A. Both cables are supplied with the N1274A.

c. Relay Control Input connector

D-sub 15 pin connector. For connecting the D-sub 15 pin cable (N1274-61722) from the External Relay Control Output connector of the N1258A. The D-sub 15 pin cable (N1274-61722) is supplied with the N1274A.

 2. Output

a. High Force output connector

Banana(jack) connector. This must be extended to the Collector/Drain terminal of a DUT. For making the connection, use a cable with banana(plug) connector, manipulators, and such.

b. Low Force output connector

Banana(jack) connector. This must be extended to the Emitter/Source terminal of a DUT. For making the connection, use a cable with banana(plug) connector, manipulators, and such.

c. High Sense output connector

HV(jack) connector. This must be extended to the Collector/Drain terminal of a DUT. For making the connection, use a cable with HV(plug) connector, manipulators, and such.

d. Low Sense output connector

BNC connector. This must be extended to the Emitter/Source terminal of a DUT. For making the connection, use a cable with BNC(m) connector, manipulators, and such.

e. Gate output connector

BNC connector. This must be extended to the Base/Gate terminal of a DUT. For making the connection, use a cable with BNC(m) connector, manipulators, and such.

This is connected to the High force/sense terminals of MCSMU/HCSMU connected for driving the DUT.

## Rear Panel

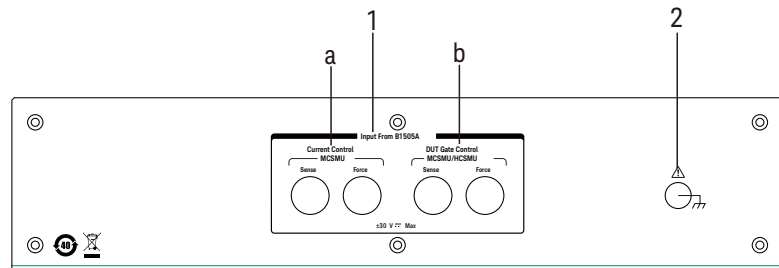

### 1. Input From B1505A

#### a. Current Control MCSMU Force and Sense input connectors

Force and Sense triaxial connectors. For connecting the 16494A triaxial cable from an MCSMU in the B1505A mainframe.

This is used to drive a current control device.

#### b. DUT Gate Control MCSMU/HCSMU Force and Sense input connectors

Force and Sense triaxial connectors. For connecting the 16494A triaxial cable from an MCSMU in the B1505A mainframe. Or, for connecting the 16493S HCSMU cable from an HCSMU in the B1505A mainframe.

This is used to drive the DUT for the Base/Gage.

### 2. Frame ground terminal

Connect to the frame ground terminal of the prober station.

## To Mount Current Control Device or Load Resistor

1. Remove the small panel on the adapter top. Then remove four screws by using a T-10 torx driver.

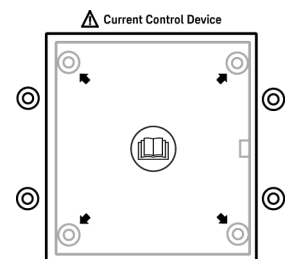

Accessories

2. Mount the current control device on the socket or the load resistor on the studs.
3. Replace and secure the small panel.  
Do not perform measurement without the panel.

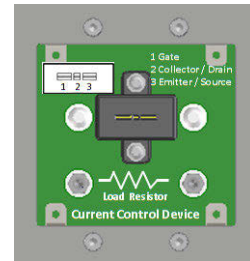

**Table 3-19**

**Connectors and Maximum Voltage/Current of N1274A**

Connector Label	Maximum Voltage	Maximum Current
Input from N1258A		
High Force	3000 V	20 A
High Sense	3000 V	200 mA
Low Force	10 V	20 A
Low Sense	10 V	20 mA
Input From B1505A		
Current Control MCSMU Force	30 V	1 A
Current Control MCSMU Sense	30 V	1 A
DUT Gate Control MCSMU/HCSMU Force	30 V	1 A
DUT Gate Control MCSMU/HCSMU Sense	30 V	1 A
Output		
High Force	3000 V	20 A
High Sense	3000 V	20 mA
Low Force	10 V	20 A
Low Sense	10 V	20 mA
Gate	30 V	1 A

## N1275A On-Wafer Gate Charge Measurement Adapter for N1265A

The N1275A is an adapter to enable on-wafer gate charge measurements with the UHCU (max. 500 A) and HVSMU (max. 3 kV). You need to switch signal paths of IV measurement and gate charge measurement manually. And also, you need manual switching between high voltage and high current gate charge measurements. The adapter output can be extended to your prober station by using the N1254A-524 prober system cable.

### WARNING



**Install the N1275A in the shielding box equipped with the interlock circuit.**

**Installer le N1275A dans la boîte de protection équipée d'un circuit de verrouillage.**

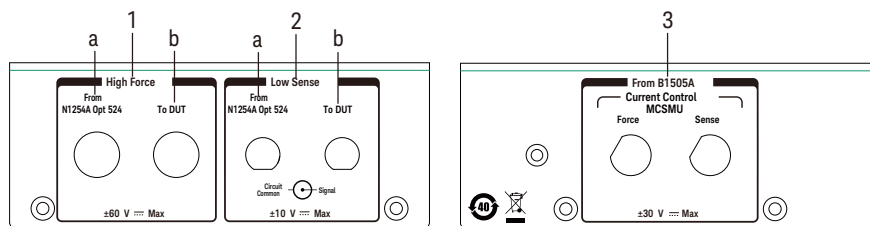

### Front and Rear Panels

#### 1. High Force

- a. From N1254A Opt524 input connector

Banana(jack) connector. For connecting the banana cable (N1275-61701) from the High Force output connector of the N1254A-524. The banana cable (N1275-61701) is supplied with the N1275A.

- b. To DUT output connector

Banana(jack) connector. This must be extended to the Collector/Drain terminal of a DUT. For making the connection, use a cable with banana(plug) connector, manipulators, and such.

2. Low Sense

- a. From N1254A Opt524 input connector

BNC connector. For connecting the BNC cable (B1512-61741) from the Low Sense output connector of the N1254A-524. The BNC cable (B1512-61741) is supplied with the N1275A.

- b. To DUT output connector

BNC connector. This must be extended to the Emitter/Source terminal of a DUT. For making connection, use a cable with BNC(m) connector, manipulators, and such.

3. From B1505A

- Current Control MCSMU Force and Sense input connectors

Force and Sense triaxial connectors. For connecting 16494A triaxial cable from an MCSMU in the B1505A mainframe.

This is used to drive a current control device.

Figure 3-34

**On-Wafer Gate Charge Measurement Adapter**

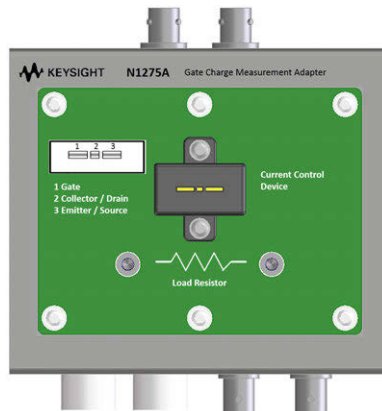

To perform the gate charge measurement, a current control device or a load resistor must be mounted on the socket or the studs.

The current control device must be a 3-pin inline package device which is expected to have the same characteristics as DUT. If the device is not available, use a load resistor. The resistor must satisfy the following specifications.

$$\text{Resistance} = V_r / I_r \text{ (} V_r \text{: rated voltage, } I_r \text{: rated current)}$$

$$\text{Peak power} \geq V_r \times I_r \times 1 \text{ ms}$$



---

**4**

## **Installation**

This chapter describes how to install Keysight B1505A and accessories.

- “Requirements”
- “Inspection and Installation”
- “Maintenance”
- “About Plug-in Modules”

To change the GPIB address of the B1505A, see “To Change GPIB Address” on page 4-12.

To control external GPIB devices from the B1505A/EasyEXPERT, see “To Enable System Controller” on page 4-13.

For the connection of accessories, see Keysight B1505A *Configuration and Connection Guide*.

---

**WARNING**

To avoid electrical shock and instrument damage, turn the all instruments off before connecting or disconnecting measurement cable.

Pour éviter une décharge électrique et un risque d'endommagement de l'appareil, mettez tous les appareils hors tension avant de brancher ou de débrancher le câble de mesure.

---

**WARNING**

The B1505A, the N1265A ultra high current expander/fixture, and the N1268A ultra high voltage expander are heavy and require a two person lift.

Le B1505A, le N1265A ultra high current expander/fixture et le N1268A ultra high voltage expander sont lourds et nécessitent deux personnes pour les soulever.

---

**CAUTION**

Do not grab the fixture cover when lifting the N1259A or N1265A test fixture.

---

**WARNING**

There are potentially hazardous voltages ( $\pm 10$  kVdc for UHVU,  $\pm 3000$  Vdc for HVSMU,  $\pm 2200$  V pulse for HVMCU,  $\pm 200$  Vdc for HPSMU, and  $\pm 100$  Vdc for MPSMU) present at the High, Force, Guard, and Sense terminals of the instruments. To prevent electrical shock, the following safety precautions must be observed during the use of instruments.

- Use three-conductor AC power cable to connect the instrument to an electrical ground (safety ground).

For both the N1265A and the N1268A, also connect a wire from an electrical ground (safety ground) to the earthing terminal.

- If you use prober and such instead of the test fixture, you must install and connect an interlock circuit that opens the circuit when the shielding box access door is open.
- If you change the DUT interface, test fixture, prober, and such, connect an interlock cable to the one actually used.
- If the N1268A is used, connect an interlock cable between the B1505A and the N1268A's Interlock Input, and connect an extra interlock cable between the N1268A's Interlock Output and the test fixture or the shielding box.
- Confirm periodically that the interlock function works normally.
- Before touching the connections on the High, Force, Guard, and Sense terminals in the test fixture or the shielding box, turn the instruments off and discharge any capacitors. If you do *not* turn the instruments off, complete *all* of the following items, regardless of the instrument settings.
  - Press the front panel Stop key to set the module output off.
  - Confirm that the front panel High Voltage indicator is not lit.
  - If the N1268A is used, press the High Voltage Enable switch to disable the high voltage output. And confirm that this red switch is not lit.
  - Open the Interlock terminal (open the fixture cover or the shielding box access door).
  - Discharge any capacitors connected to a measurement resource.
- Warn persons working around the instruments about dangerous conditions.

---



---

**WARNING**

Une tension dangereuse (max.  $\pm$  pour UHVU; 10 kVdc, max.  $\pm$  pour HVSMU; 3000 Vdc, max.  $\pm$  pour HVMCU; 2200 Vpulse, max.  $\pm$  pour HPSMU; 200 Vdc, max.  $\pm$  pour MPSMU; 100 Vdc) émanant du dispositif Keysight B1505A peut être sortie aux bornes High, Force, Guard et Sense. Les précautions suivantes doivent être observées contre commotion électrique accidentelle.

- Utilisez un câble d'alimentation CA à trois conducteurs vers le coupleur secteur (entrée) et branchez l'instrument sur une mise électrique à la terre (prise de terre de sécurité).
- Si vous utilisez une sonde ou un outil similaire au lieu de l'équipement de test, vous devez installer et connecter un circuit de sécurité qui ouvre le circuit lorsque la porte d'accès au boîtier de protection est ouverte.

- **Si vous changez l'interface MST, l'équipement de test, la sonde, ou tout autre élément, connectez un cordon d'enclenchement à celui utilisé actuellement.**
  - **Si le N1268A est utilisé, connectez un câble de verrouillage entre le B1505A et Interlock Input du N1268A, puis connectez un câble de verrouillage supplémentaire entre Interlock Output du N1268A et l'équipement de test ou la boîte de protection.**
  - **Vérifiez régulièrement le bon fonctionnement de la fonction de sécurité.**
  - **Avant de toucher les connexions des bornes High, Force, Guard et Sense, mettez l'instrument hors tension et déchargez tout condensateur du chemin de mesure. Si vous ne mettez pas l'instrument hors tension, effectuez « toutes » les opérations ci-dessous, quels que soient les paramètres de l'instrument.**
    - **Terminez les mesures en appuyant sur la touche Stop ; vérifiez que l'indicateur d'état Measurement est éteint.**
    - **Vérifiez que le témoin High Voltage est éteint.**
    - **Si le N1268A est utilisé, enfoncez le commutateur High Voltage Enable pour désactiver la sortie haute tension. Et confirmez que le commutateur rouge n'est pas allumé.**
    - **Ouvrez la trappe d'accès au boîtier de protection (ouvrez la borne Interlock).**
    - **Déchargez les éventuels condensateurs si la capacité est connectée à une unité SMU.**
  - **Informez les personnes travaillant à proximité de l'instrument des conditions.**
-

## Requirements

This section contains information on:

- “Power Requirements”
- “Operating Environment”
- “Storing/Shipping Environment”
- “Installation Requirements”
- “Power Cable”

### Power Requirements

This instrument can operate from any single-phase AC power source supplying 100-240 V ( $\pm 10\%$ ) at 50/60 Hz. The maximum power consumption is 900 VA.

### Operating Environment

This instrument is specified to operate within the following environmental conditions:

<b>Temperature:</b>	5 °C to 40 °C
<b>Humidity:</b>	20 % to 70 % RH, non-condensing
<b>Altitude:</b>	0 to 2,000 m (6,561 ft.)

### Storing/Shipping Environment

This instrument is specified to store/ship within the following environmental conditions:

<b>Temperature:</b>	-20 °C to 60 °C
<b>Humidity:</b>	10 % to 90 % RH, non-condensing 20 % to 80 % RH, non-condensing, for using N1268A
<b>Altitude:</b>	0 to 4,600 m (15,092 ft.) 0 to 2,000 m (6,561 ft.), for using N1268A

## Installation Requirements

---

**WARNING**

**Do not operate the instrument in dusty environment, or in the presence of flammable gases, corrosive gases, or fumes.**

**Ne pas utiliser l'appareil dans un endroit poussiéreux, ou en présence de gaz inflammables, corrosifs ou de fumée.**

- 
- Environmental conditions for this instrument are documented in “**Operating Environment**” on page 4-5. In principle, this instrument should only be operated indoors in a controlled environment.
  - Install the instrument horizontal place then face the roof up.
  - Fan cools the instrument by drawing air through the sides and exhausting it out the back. The instrument must be installed in a location that allows sufficient space at the sides and back of the instrument for adequate air circulation.

If the airflow is restricted, the internal operating temperature will be higher. This may reduce the instrument’s reliability, or cause the thermal-protection circuits to turn the instrument off.

- Make sure that there is enough space for connecting/disconnecting the power cable easily.

---

**WARNING**

**Do not put anything on the N1268A Ultra High Voltage Expander.**

**Ne rien placer sur le N1268A Ultra High Voltage Expander.**

---

## Power Cable

---

**WARNING**

**FIRE HAZARD:** Use only the power cable supplied with your instrument. Using other types of power cable may cause overheating of the power cable, resulting in fire.

**SHOCK HAZARD:** The power cable provides the chassis ground through a third conductor. Be sure to connect to a three-conductor type power outlet with the correct pin grounded.

**RISQUE D'INCENDIE :** utilisez uniquement le câble d'alimentation fourni avec votre appareil. L'utilisation d'autres types de câble d'alimentation peut provoquer une surchauffe du câble d'alimentation et provoquer un incendie.

**RISQUE DE CHOC ÉLECTRIQUE :** le câble d'alimentation fournit la masse du châssis par le biais d'un troisième conducteur. Assurez-vous de connecter la prise d'alimentation de type trois conducteurs au boîtier exact mis à terre.

---

**NOTE**













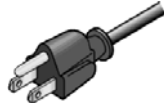

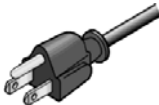

---

The detachable power cable may be used as an emergency disconnecting device. Removing the power cable will disconnect AC input power to the instrument.

Connect the power cable to the IEC 60320 connector on the rear of the instrument. If the wrong power cable was shipped with your instrument, contact your nearest Keysight Sales and Support Office.

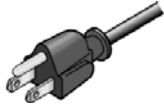
The AC input on the back of your instrument is a universal AC input. It accepts nominal line voltages in the range of 100 to 240 VAC.

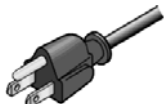
Installation  
Requirements

<p>Option 900</p>  <ul style="list-style-type: none"> <li>• Plug: BS 1363/A, 250 V, 10 A</li> <li>• PN: 8120-4420</li> </ul>	<p>Option 901</p>  <ul style="list-style-type: none"> <li>• Plug: AS/NZS 3112, 250 V, 10 A</li> <li>• PN: 8120-4419</li> </ul>	<p>Option 902</p>  <ul style="list-style-type: none"> <li>• Plug: IEC 60277-1, 250 V, 10 A</li> <li>• PN: 8121-1226</li> </ul>	<p>Option 903</p>  <ul style="list-style-type: none"> <li>• Plug: NEMA 5-15P, 125 V, 10 A</li> <li>• PN: 8120-6825</li> </ul>
<p>Option 904</p>  <ul style="list-style-type: none"> <li>• Plug: NEMA 6-15P, 250 V, 10 A</li> <li>• PN: 8120-3996</li> </ul>	<p>Option 906</p>  <ul style="list-style-type: none"> <li>• Plug: SEV 1011, 250 V, 10 A</li> <li>• PN: 8120-4416</li> </ul>	<p>Option 912</p>  <ul style="list-style-type: none"> <li>• Plug: SB 107-2-D1, 250 V, 10 A</li> <li>• PN: 8121-1655</li> </ul>	<p>Option 917</p>  <ul style="list-style-type: none"> <li>• Plug: IS 1293 and IS 6538, 250 V, 10 A</li> <li>• PN: 8121-1690</li> </ul>
<p>Option 918</p>  <ul style="list-style-type: none"> <li>• Plug: JIS C 8303, 125 V, 12 A</li> <li>• PN: 8121-0743</li> </ul>	<p>Option 919</p>  <ul style="list-style-type: none"> <li>• Plug: Israel SI 32, 250 V, 10 A</li> <li>• PN: 8121-0724</li> </ul>	<p>Option 920</p>  <ul style="list-style-type: none"> <li>• Plug: IRAM 2073, 250 V, 10 A</li> <li>• PN: 8121-0725</li> </ul>	<p>Option 921</p>  <ul style="list-style-type: none"> <li>• Plug: CEI 23-16, 250 V, 10 A</li> <li>• PN: 8121-0722</li> </ul>
<p>Option 922</p>  <ul style="list-style-type: none"> <li>• Plug: GB 1002 figure 3, 250 V, 10 A</li> <li>• PN: 8120-8376</li> </ul>	<p>Option 923</p>  <ul style="list-style-type: none"> <li>• Plug: SANS 164-1, 250 V, 10 A</li> <li>• PN: 8121-0564</li> </ul>	<p>Option 927</p>  <ul style="list-style-type: none"> <li>• Plug: NEMA WD-6, 250 V, 10 A</li> <li>• PN: 8120-0674</li> </ul>	<p>Option 930</p>  <ul style="list-style-type: none"> <li>• Plug: NBR 14136, 250 V, 10 A</li> <li>• PN: 8121-1809</li> </ul>
<p>Option 931</p>  <ul style="list-style-type: none"> <li>• Plug: CNS 10917-2, 125 V, 10 A</li> <li>• PN: 8121-1635</li> </ul>	<p>Option 932</p>  <ul style="list-style-type: none"> <li>• Plug: CS 0017, 250 V, 10 A</li> <li>• PN: 8121-1638</li> </ul>		



## Inspection and Installation

This section describes what to do when you receive the instrument and accessories.

1. Inspect the shipment. See [“To Inspect B1505A and Accessories”](#).
2. Verify the instrument operation and perform initial setup. See [“To Perform Initial Setup”](#).
3. Install the instrument in the appropriate place. See [“Requirements” on page 4-5](#).

To use the instrument briefly, see [“Getting Started” on page 1-1](#).

To change the Windows logon setting, see [“To Change Windows Logon Setting” on page 4-11](#).

To change the GPIB address of the instrument, see [“To Change GPIB Address” on page 4-12](#).

To allow the B1505A/EasyEXPERT to control external GPIB devices, see [“To Enable System Controller” on page 4-13](#).

### To Inspect B1505A and Accessories

Perform the following inspections when the instrument and accessories arrive at your site.

1. Before unpacking any components, inspect all boxes for any signs of damage that might have occurred during shipment, such as:
  - dents
  - scratches
  - cuts
  - water marks

If you suspect any damage, notify your local Keysight Technologies sales or service office.

2. When you open the boxes that contain the instrument and accessories, check the components against the contents lists attached to the boxes.

If anything is missing, notify your local Keysight Technologies sales or service office.

## To Perform Initial Setup

After you receive the instrument, perform the following setup.

For the users available just after the initial setup, see [Table 4-1](#).

1. Make sure that the Standby switch is set to off.
2. On the instrument rear panel, connect the Circuit Common terminal to the frame ground terminal by using a shorting-bar.
3. If you use Keysight 16444A-001 USB keyboard and/or the 16444A-002 USB mouse, connect it to an USB port of the instrument.
4. Connect the power cable from the instrument to an AC power outlet.
5. Open the measurement terminals and press the Standby switch to turn on the instrument.

If the instrument is operating correctly, the power-on self-test is automatically performed. If problems arise, see *Keysight EasyEXPERT User's Guide*.

6. Follow the Windows setup wizard and complete the initial setup.
  - a. Set the system display language to English. The language must be English.
  - b. Set Country or region, Time and currency, and Keyboard layout.  
If you use the 16444A-001 USB keyboard, the Keyboard layout must be US.
  - c. Accept the End User License Agreement.
  - d. Set Time zone, date and time.

If the instrument has been already connected to your site LAN, you can proceed the network connection setup.

---

**NOTE****Other Windows setup**

You can set other setup of Windows after the initial setup. It is your responsibility.

**Table 4-1 Users Available Just After the Initial Setup**

User Account	Description
Keysight B1500 User	Account for automatic logon. Password is not set to this account.
KeysightOnly	Account for Keysight service personnel. Do not delete this account. This account is password protected.
Administrator	Administrator. Password is not set to this account.

You can add users after the initial setup. Add users as you need.

## To Change Windows Logon Setting

Keysight B1505A initially enables Windows automatic logon. If you want to change this setting, select *All Programs > Control Auto Logon* from the Start menu. Control Auto Logon is displayed on the browser. Then click one of the following buttons on the browser and follow the setup script.

- Enable Auto Logon
- Disable Auto Logon

---

**NOTE**

---

If you set a password for the user account *Keysight B1500 User*, disable the automatic logon.

## To Change GPIB Address

When this instrument is shipped from the factory, the GPIB address is set to 17. To change the GPIB address, perform the following procedure.

1. If the EasyEXPERT software is running, terminate it as shown below:
  - a. Select the menu function *File > Exit* on the EasyEXPERT main screen.
  - b. Click [x] at the upper right corner of the Start EasyEXPERT button.
2. Select *All Programs > Keysight IO Libraries Suite > Keysight Connection Expert* from the Start menu. Keysight Connection Expert window appears.
3. At the *Instrument I/O on this PC* area, select GPIB0, and click the Change Properties... button. Keysight 82350 PCI GPIB Interface - GPIB0 window appears.
4. Change the GPIB Address value.
5. Remove the check from the *Auto-discover instruments connected to this interface* box.
6. Click the OK button on Keysight 82350 PCI GPIB Interface - GPIB0 window.
7. On the Reboot Required dialog box, click the Reboot Now button, and reboot the instrument.

---

**NOTE**

For the GPIB connection of this instrument, use an GPIB interface, Keysight 82350B (for PCI bus), Keysight 82357A/B (USB/GPIB), or National Instrument GPIB-USB-HS.

For using an USB/GPIB interface, it is recommended to set the GPIB address of this instrument to an even number. The USB/GPIB interface might cause serial poll error intermittently due to the intrinsic communication scheme differences. It is reported that using an even GPIB address sometimes significantly decreases the chance of the error.

---

## To Enable System Controller

To allow Keysight B1505A/EasyEXPERT to control external GPIB devices, perform the following procedure.

1. If the EasyEXPERT software is running, terminate it as shown below:
  - a. Select the menu function *File > Exit* on the EasyEXPERT main screen.
  - b. Click [x] at the upper right corner of the Start EasyEXPERT button.
2. Select *All Programs > Keysight IO Libraries Suite > Keysight Connection Expert* from the Start menu. Keysight Connection Expert window appears.
3. At the *Instrument I/O on this PC* area, select GPIB0, and click the *Change Properties...* button. Keysight 82350 PCI GPIB Interface - GPIB0 window appears.
4. Set the GPIB Address value to 21 that is the typical address number for the system controller.
5. Check the *System Controller* box.
6. Remove the check from the *Auto-discover instruments connected to this interface* box.

This disables the automatic device detection. So the Connection Expert cannot detect the instruments connected to the GPIB interface by itself.
7. Click the OK button on Keysight 82350 PCI GPIB Interface - GPIB0 window.
8. On the Reboot Required dialog box, click the Reboot Now button, and reboot the instrument.

---

### NOTE

#### To Disable System Controller

If the B1505A is the system controller, you cannot control the B1505A by using an external computer. To disable the system controller, change the steps 4 and 5 for setting the GPIB Address value to *not* 21 and removing the check from the *System Controller* box, and perform the procedure to the step 8.

---

## Maintenance

Maintenance should be performed periodically to keep the instrument in good condition.

### Cleaning

Before performing cleaning, turn off the instrument, and disconnect power cable from the rear panel. Use a dry cloth to clean the external case parts.

To prevent electrical shock, do not perform cleaning when the instrument is turned on, and do not use a wet cloth.

### Self-test and Diagnosis

This instrument provides the following functions to check the operation. Perform the following functions as necessary. Open the measurement terminals to perform self-test, self-calibration, or diagnosis.

- Self-test
- Self-calibration
- Diagnosis

If problems arise, contact Keysight Technologies. For details, see Keysight EasyEXPERT *User's Guide*.

---

#### NOTE

##### **Before performing the diagnosis of N1265A UHC Expander / Fixture**

When the diagnosis of the N1265A is performed, the N1266A HVSMU Current Expander must not be connected to the N1265A.

If the N1266A is connected between the N1265A and the HVSMU, disconnect the cables from the following connectors.

- Selector Input HVSMU connector of the N1265A
- Input HVSMU connector of the N1266A

And connect the cable between the Selector Input HVSMU connector of the N1265A and the HVSMU before performing the diagnosis of the N1265A.

---

**WARNING**



**Interlock Open/Close test and High Voltage LED test**

**Interlock function limits the maximum output voltage to  $\pm 42$  V when the measurement terminal is touchable. For safety, this function must be checked before using the B1505A after power on at least once a day by performing the diagnosis.**

**To verify the interlock function, perform the Interlock Open/Close test on the Main Frame tab screen of the EasyEXPERT Configuration window.**

**Test d'ouverture/de fermeture Interlock et test High Voltage LED**

**La fonction de verrouillage limite la tension de sortie maximale à  $\pm 42$  V lorsque la borne de mesure peut être touchée. Pour des raisons de sécurité, cette fonction doit être vérifiée avant d'utiliser le B1505A après la mise sous tension, au moins une fois par jour en effectuant le diagnostic.**

**Pour vérifier la fonction de verrouillage, effectuer l'Interlock Open/Close test sur l'écran de l'onglet Main Frame de la fenêtre EasyEXPERT Configuration.**

---

## **Calibration**

Calibration and adjustments must be performed periodically so that the instruments satisfy the specifications, and keep a good condition. It is recommended to perform the calibration once a year at least. For the calibration and adjustments, contact Keysight Technologies. Trained service personnel will perform the calibration and adjustments. Also see Keysight EasyEXPERT *User's Guide*.

## About Plug-in Modules

Module locations when the B1505A is shipped from the factory are shown in [Table 4-2](#). This table shows the relative locations by the module types. The same type of modules must be installed in the contiguous slots.

For example, if the module configuration is two HPSMU, one MFCMU, one HCSMU, and one HVSMU, the B1505A will be shipped with the HPSMU of the slots 1 to 4, the MFCMU of the slot 5, the HCSMU of the slots 6 to 7, the HVSMU of the slots 8 to 9, and the blank panel of the slot 10.

Module installation must be carried out at an Keysight Technologies service center. Contact Keysight Technologies for the module installation. Then send the following equipment and accessories to Keysight Technologies.

- B1505A
- Plug-in modules to be installed

---

### WARNING



**To prevent electrical shock, turn the instrument off and remove the power cable before removing the connection cables.**

**Afin d'éviter toute décharge électrique, mettez l'appareil hors tension et débranchez le cordon d'alimentation avant de retirer les câbles de connexion.**

---

### NOTE

#### Module locations after servicing

After the module installation, upgrade, and so on, the B1505A will be returned with the module configuration decided by the rule shown in [Table 4-2](#). If you want to change the module locations, consult the service personnel before servicing.

---



**Table 4-2**                      **Module Installation Rule**

<b>Slot Number and Location</b>		<b>Module Type</b>
10	top	B1513A/B/C High Voltage SMU (HVSMU)
⋮	⋮	B1512A High Current SMU (HCSMU)
⋮	⋮	B1514A Medium Current SMU (MCSMU)
⋮	⋮	B1520A Multi Frequency CMU (MFCMU)
⋮	⋮	B1511A/B Medium Power SMU (MPSMU)
1	⋮	B1510A High Power SMU (HPSMU)
0	bottom	GNDU/ADC (always installed)

Installation  
About Plug-in Modules

---

**5**

## **Measurement Examples**

## Measurement Examples

This chapter introduces some measurement examples using Keysight B1505A.

- “Gate Charge Measurement”
- “I-V and Capacitance Measurements Using N1272A”
- “Temperature Controlled by Thermal Plate”
- “Temperature Controlled by ThermoStream”
- “Using Multiple HVSMU Modules”

---

## Gate Charge Measurement

This section introduces the Power MOSFET gate charge measurement examples.

The gate charge measurement is comprised of two measurements (high current and high voltage gate charge measurements) and one characteristics extraction using two measurement results. First, you need to decide the following three key conditions to drive DUT.

- Off voltage  
Load voltage that DUT blocks during off state of switching operation.
- On current  
On current that flows through the DUT during on state of switching operation.
- Range of gate voltage  
Gate voltages to turn on DUT and turn off DUT during switching operation.

This section consists of the following sub-sections.

- “Preparing Measurement”
- “System Configuration and Open/Short Calibration”
- “Preparing Measurement Setups and Performing Measurements”

### Preparing Measurement

---

#### WARNING



**Set the instrument output off before connecting or disconnecting a connection wire.**

**Press the B1505A front panel Stop key to set the output off. And confirm that the B1505A front panel High Voltage indicator is not lit.**

**Désactivez la sortie de l'appareil avant de brancher ou de débrancher un câble de connexion.**

**Appuyez sur la touche Stop du panneau avant du B1505A pour désactiver la sortie. Et confirmez que l'indicateur de tension High du panneau avant du B1505A n'est pas allumé.**

---

---

**WARNING**

**To prevent electrical shock and DUT damage, do not connect or disconnect the DUT while the instrument is applying voltage or current.**

**When you touch the DUT after measurement, devise a countermeasure of residual charge and heat to prevent electrical shock and burn. Use gloves and any tool. Also have enough time for discharge and radiation.**

**Afin d'éviter toute décharge électrique et dommage MST, ne branchez ou débranchez pas la sortie MST alors que l'appareil envoie de la tension ou du courant.**

**Lorsque vous touchez le MST après la mesure, élaborer une contre-mesure de la charge résiduelle et du chauffage afin d'éviter tout choc électrique et toute brûlure. Utilisez des gants et des outils. Prévoyez également du temps pour la décharge et la radiation.**

---

Prepare a measurement as follows:

1. Connect the test fixture, the socket module, the adapter, and the required accessories.

For more information, see the following sections:

- “N1259A Test Fixture” on page 3-9 and “Gate charge socket module (N1259A-014)” on page 3-23
- “N1265A Ultra High Current Expander/Fixture” on page 3-33 and “Gate charge socket module (N1265A-014)” on page 3-49
- “N1274A On-Wafer Gate Charge Measurement Adapter/Selector for 20 A/3 kV” on page 3-99
- “N1275A On-Wafer Gate Charge Measurement Adapter for N1265A” on page 3-103

2. Prepare a DUT (device under test) and a current control device (current load device) or a load resistor (resistive load).

The current control device must be a 3-pin inline package device which is expected to have the same characteristics as DUT. If the device is not available, use a load resistor. The resistor must satisfy the following specifications.

Resistance =  $V_r/I_r$  ( $V_r$ : rated voltage,  $I_r$ : rated current)

Peak power  $\geq V_r \times I_r \times 1 \text{ ms}$

3. Turn the instrument on.  
Do not connect the devices at this time.

## System Configuration and Open/Short Calibration

Select adapter and measurement resources used for the measurement, and then measure the Open and Short calibration data of the selected adapter as follows.

1. Click the *Configuration* button in the EasyEXPERT main window.  
The Configuration window appears.
2. Click the *Gate Charge Adapter* tab to display the Gate Charge Adapter tab screen.
3. Select the adapter to be used, and specify the measurement resources to be used.
4. Click the *Start Calibration...* button to measure the calibration data.  
The Gate Charge Calibration dialog box appears.

If you have measured and saved the calibration data of the measurement path, click the *Select Calibration Data...* button to select and load the stored calibration data. Go to the step 7.

5. Click the *Start* button.  
Follow the instruction displayed on the dialog to measure the open and short calibration data.
6. After finishing the calibration, click the *Save and Apply* button to save and apply the calibration data.
7. Click the *Close* button to close the dialog box.
8. Click the *Apply* button to apply the present settings, and then click the *Close* button to close the Configuration window.

## Preparing Measurement Setups and Performing Measurements

You can use some application tests to perform the gate charge measurement. The following sections describe how to select and use application tests according to the MOSFET gate charge measurement examples. You can know information for IGBT devices by replacing the DUT terminal names. For example, *Qg (High Id + High Vds+ JESD24-2)* in the *PowerMOSFET* category corresponds to *Qg (High Ic + High Vce+ JESD24-2)* in the *IGBT* category.

For details of the application tests, see the help message for each test definition.

- [“Packaged Device Testing Using Current Load Transistor on the N1259A-014 or N1265A-014”](#)

Measurement Examples  
Gate Charge Measurement

- “Packaged Device Testing Using Resistive Load on the N1259A-014 or N1265A-014”
- “On-Wafer Auto-Testing Using Current Load Transistor on the N1274A”
- “On-Wafer Auto-Testing Using Resistive Load on the N1274A”
- “On-Wafer Auto-Testing Using Current Load Transistor on the N1275A”
- “On-Wafer Auto-Testing Using Resistive Load on the N1275A”

## Packaged Device Testing Using Current Load Transistor on the N1259A-014 or N1265A-014

### Preparing Measurement Setup

Used Application Test: *Qg (High Id + High Vds + JESD24-2)*

1. Specify an approximate expected total gate charge value to the *QgMaxXAxis* parameter and specify an expected threshold voltage to the *VgsTh* parameter.
2. Specify the Off voltage and On current to the *VdsOff* and *IdOn* parameters according to your switching condition.
3. Specify the measurement range of the gate voltage using the *VgsOff* and *VgsOn* parameters. If a resistor is directly connected to the DUT gate terminal in series for preventing oscillation, specify the resistance value of the resistor to the *RgDUT* parameter.
4. Specify the gate voltage range of the transistor for the current load using the *LoadVgsOff* and *LoadVgsOn* parameters. For the *LoadVgsOff* parameter, specify a gate voltage that the transistor is perfectly turned off. For the *LoadVgsOn* parameter, specify a gate voltage that the transistor is perfectly turned on. Both voltages should be within the maximum rating voltage of the transistor.

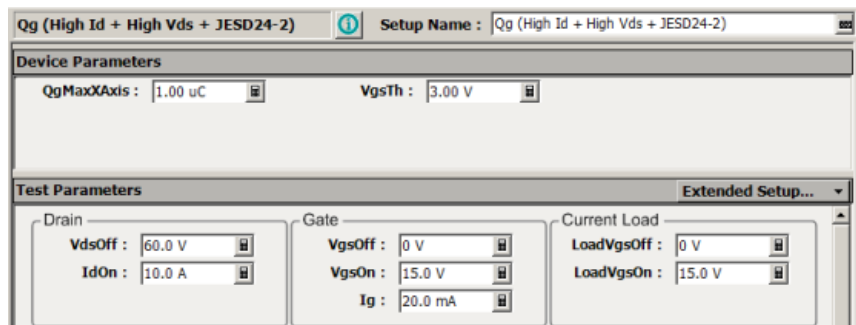



## Performing the Measurement

1. Click the  Single button to start measurement. This opens the Data Display window.
2. When a message is displayed to prompt for the high current gate charge measurement connections, connect the devices properly and then click *OK*. This starts the high current gate charge measurement.
3. When a message is displayed to prompt for the high voltage gate charge measurement connections, connect the devices properly and then click *OK*. This starts the high voltage gate charge measurement.

## Checking the Measurement Result

After the measurement, the gate charge characteristics will be displayed on the Data Display window. If an error occurs, follow the error message.

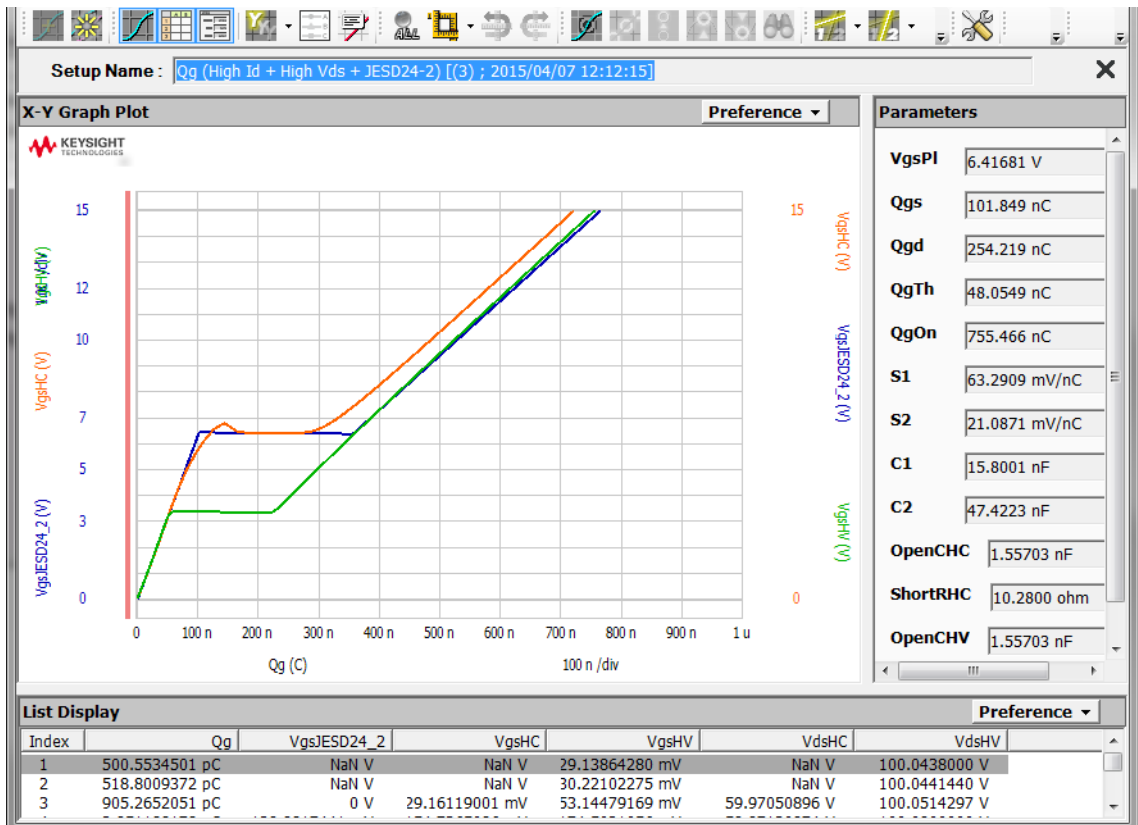

## Measurement Examples

### Gate Charge Measurement

You can also observe the switching waveforms as shown below.

1. Click the *Results* button at the lower position of the main screen to show the pull-down menu, and then select *Filter > Expand Application Test Results* to activate this function.
2. Select a measurement result of the *Qg (High Id Switching)* or *Qg (High Vds Switching)* in the list of the *Results*. And then, right-click it to open the pop-up menu, and select the *Display Data*. The switching waveforms are displayed in the Data Display window.

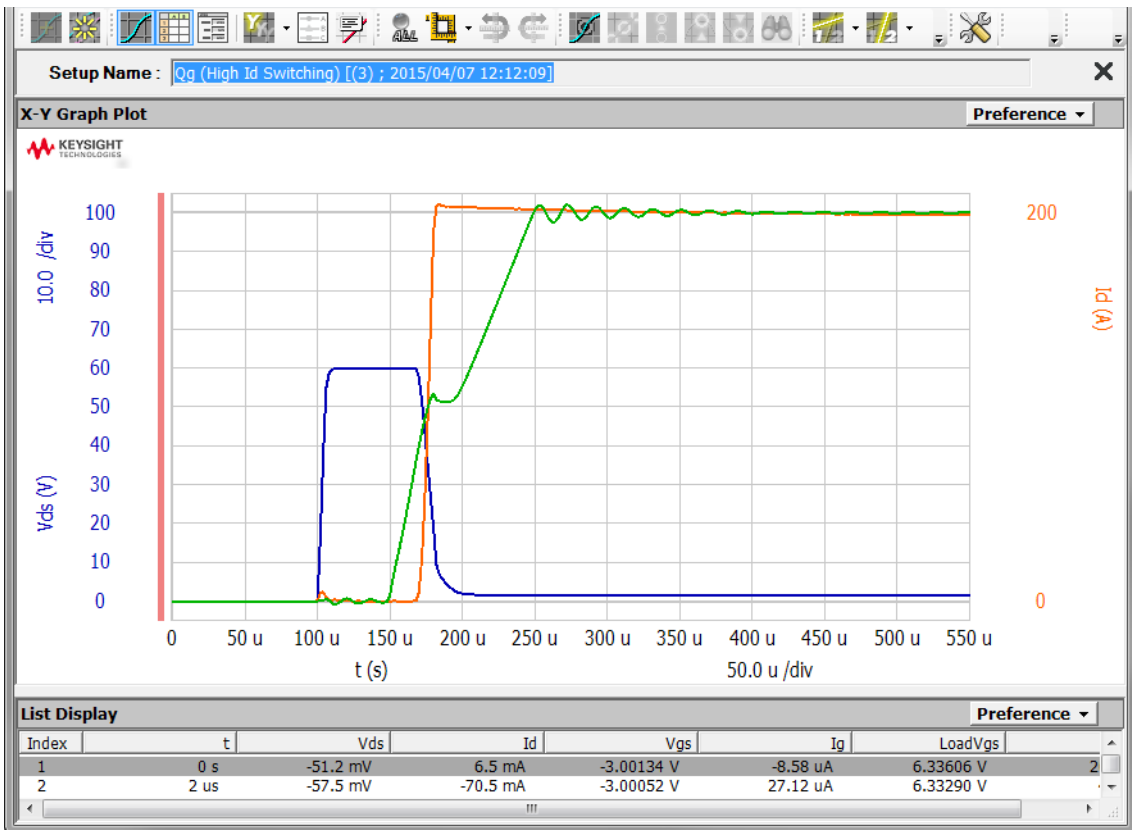

### Adjusting the Measurement Condition

The charging interval on the gate charge characteristics increases in proportion to the switching speed. If the charge interval is too long, decrease the gate current  $I_g$ .

## Packaged Device Testing Using Resistive Load on the N1259A-014 or N1265A-014

### Preparing Measurement Setup

Used Application Test: *Qg (R Load High Id + High Vds+ JESD24-2)*

1. Specify an approximate expected total gate charge value to the *QgMaxXAxis* parameter and specify an expected threshold voltage to the *VgsTh* parameter.
2. Specify the On current to the *IdOn* parameter according to your switching condition. For the *VdsOff* parameter, specify the upper limit value to automatically search for the load voltage when the On current flows to the active DUT.
3. Specify the measurement range of the gate voltage using the *VgsOff* and *VgsOn* parameters. If a resistor is directly connected to the DUT gate terminal in series for preventing oscillation, specify the resistance value of the resistor to the *RgDUT* parameter.

### Performing the Measurement

1. Click the  Single button to start measurement. This opens the Data Display window.
2. When a message is displayed to prompt for the high current gate charge measurement connections, connect the devices properly and then click *OK*. This starts the high current gate charge measurement.
3. When a message is displayed to prompt for the high voltage gate charge measurement connections, connect the devices properly and then click *OK*. This starts the high voltage gate charge measurement.

### Checking the Measurement Result

After the measurement, the gate charge characteristics will be displayed on the Data Display window. If an error occurs, follow the error message.

You can also observe the switching waveforms as shown below.

1. Click the *Results* button at the lower position of the main screen to show the pull-down menu, and then select *Filter > Expand Application Test Results* to activate this function.

2. Select a measurement result of the *Qg (High Id Switching)* or *Qg (High Vds Switching)* in the list of the *Results*. And then, right-click it to open the pop-up menu, and select the *Display Data*. The switching waveforms are displayed in the Data Display window.

### Adjusting the Measurement Condition

The charging interval on the gate charge characteristics increases in proportion to the switching speed. If the charge interval is too long, decrease the gate current *Ig*.

## On-Wafer Auto-Testing Using Current Load Transistor on the N1274A

---

### NOTE

---

Quick test allows you to perform the gate charge measurement and the IV measurement automatically. To perform this sequential measurement, define a quick test so that a gate charge measurement setup, a IV path creation setup (IV Path (N1274A)), and a IV measurement setup are performed in this order.

### Preparing Measurement Setup

Used Application Test: *Qg (High Id + High Vds+ JESD24-2)*

1. Set the *InCaseOfError* parameter to *Continue* to prevent an abort of the automatic test execution when an error occurs on a device test. You can set this in the Extended Setup dialog box opened by the *Extended Setup ...* button.
2. Specify an approximate expected total gate charge value to the *QgMaxXAxis* parameter and specify an expected threshold voltage to the *VgsTh* parameter.
3. Specify the Off voltage and On current to the *VdsOff* and *IdOn* parameters according to your switching condition.
4. Specify the measurement range of the gate voltage using the *VgsOff* and *VgsOn* parameters.
5. Specify the gate voltage range of the transistor for the current load using the *LoadVgsOff* and *LoadVgsOn* parameters. For the *LoadVgsOff* parameter, specify a gate voltage that the transistor is perfectly turned off. For the *LoadVgsOn* parameter, specify a gate voltage that the transistor is perfectly turned on. Both voltages should be within the maximum rating voltage of the transistor.

## Performing the Measurement

1. Click the  Repeat button. This opens the Repeat Measurement Setup dialog box.
2. Specify the prober driver programs to be used to the *Start Procedure*, *Iteration Procedure*, and *Final Procedure* fields, and then check the *Automatically fill in Device ID*.
3. Uncheck the *Counter Reaching to* in the *Repeat Stop Condition* area.
4. Click the *Run* button to start the repeat measurement.

## Checking the Measurement Result

After each measurement, the gate charge characteristics will be displayed on the Data Display window. After all measurements, you can view each measurement result on the Data Display window.

You can also observe the switching waveforms as shown below.

1. Click the *Results* button at the lower position of the main screen to show the pull-down menu, and then select *Filter > Expand Application Test Results* to activate this function.
2. Select a measurement result of the *Qg (High Id Switching)* or *Qg (High Vds Switching)* in the list of the *Results*. And then, right-click it to open the pop-up menu, and select the *Display Data*. The switching waveforms are displayed in the Data Display window.

## Adjusting the Measurement Condition

The charging interval on the gate charge characteristics increases in proportion to the switching speed. If the charge interval is too long, decrease the gate current  $I_g$ .

## On-Wafer Auto-Testing Using Resistive Load on the N1274A

---

### NOTE

Quick test allows you to perform the gate charge measurement and the IV measurement automatically. To perform this sequential measurement, define a quick test so that a gate charge measurement setup, a IV path creation setup (IV Path (N1274A)), and a IV measurement setup are performed in this order.

## Preparing Measurement Setup

Used Application Test: *Qg (R Load High Id + High Vds+ JESD24-2)*

1. Set the *InCaseOfError* parameter to *Continue* to prevent an abort of the automatic test execution when an error occurs on a device test. You can set this in the Extended Setup dialog box opened by the *Extended Setup ...* button.
2. Specify an approximate expected total gate charge value to the *QgMaxXAxis* parameter and specify an expected threshold voltage to the *VgsTh* parameter.
3. Specify the On current to the *IdOn* parameter according to your switching condition. For the *VdsOff* parameter, specify the upper limit value to automatically search for the load voltage when the On current flows to the active DUT.
4. Specify the measurement range of the gate voltage using the *VgsOff* and *VgsOn* parameters.

## Performing the Measurement

1. Click the  Repeat button. This opens the Repeat Measurement Setup dialog box.
2. Specify the prober driver programs to be used to the *Start Procedure*, *Iteration Procedure*, and *Final Procedure* fields, and then check the *Automatically fill in Device ID*.
3. Uncheck the *Counter Reaching to* in the *Repeat Stop Condition* area.
4. Click the *Run* button to start the repeat measurement.

## Checking the Measurement Result

After each measurement, the gate charge characteristics will be displayed on the Data Display window. After all measurements, you can view each measurement result on the Data Display window.

You can also observe the switching waveforms as shown below.

1. Click the *Results* button at the lower position of the main screen to show the pull-down menu, and then select *Filter > Expand Application Test Results* to activate this function.
2. Select a measurement result of the *Qg (High Id Switching)* or *Qg (High Vds Switching)* in the list of the *Results*. And then, right-click it to open the pop-up menu, and select the *Display Data*. The switching waveforms are displayed in the Data Display window.

## Adjusting the Measurement Condition

The charging interval on the gate charge characteristics increases in proportion to the switching speed. If the charge interval is too long, decrease the gate current  $I_g$ .

## On-Wafer Auto-Testing Using Current Load Transistor on the N1275A

### Preparing Measurement Setups

Used Application Tests:

- $Q_g$  (High  $I_d$  + JESD24-2)
- $Q_g$  (High  $V_{ds}$  + JESD24-2)
- $Q_g$  (JESD24-2 High  $I_d$  + JESD24-2 High  $V_{ds}$ )

---

**NOTE**

---

You can create test setups in random order. This section describes it in the order of the test sequence.

1. Create a new preset group.
2. Create a test setup for high current gate charge measurement as follows.
  - a. Open the  $Q_g$  (High  $I_d$  + JESD24-2) application test.
  - b. Set the *InCaseOfError* parameter to *Continue* to prevent an abort of the automatic test execution when an error occurs on a device test. You can set this in the Extended Setup dialog box opened by the *Extended Setup ...* button.
  - c. Specify an approximate expected total gate charge value to the  $Q_gMaxXAxis$  parameter and specify an expected threshold voltage to the  $V_{gsTh}$  parameter.
  - d. Specify the Off voltage and On current to the  $V_{dsOff}$  and  $I_{dOn}$  parameters according to your switching condition.
  - e. Specify the measurement range of the gate voltage using the  $V_{gsOff}$  and  $V_{gsOn}$  parameters.
  - f. Specify the gate voltage range of the transistor for the current load using the  $LoadV_{gsOff}$  and  $LoadV_{gsOn}$  parameters. For the  $LoadV_{gsOff}$  parameter, specify a gate voltage that the transistor is perfectly turned off. For the  $LoadV_{gsOn}$  parameter, specify a gate voltage that the transistor is perfectly turned on. Both voltages should be within the maximum rating voltage of the transistor.

## Measurement Examples

### Gate Charge Measurement

- g. Save this setup to the preset group created in Step 1.
3. Create a test setup for high voltage gate charge measurement as follows.
  - a. Open the *Qg (High Vds + JESD24-2)* application test.
  - b. Set the *InCaseOfError* parameter to *Continue* to prevent an abort of the automatic test execution when an error occurs on a device test. You can set this in the Extended Setup dialog box opened by the *Extended Setup ...* button.
  - c. Specify an approximate expected total gate charge value to the *QgMaxXAxis* parameter and specify an expected threshold voltage to the *VgsTh* parameter.
  - d. Specify the Off voltage to the *VdsOff* parameter according to your switching condition.
  - e. Specify the measurement range of the gate voltage using the *VgsOff* and *VgsOn* parameters.
  - f. Save this setup to the preset group created in Step 1.
4. Create a test setup for extracting the high current and high voltage gate charge characteristics from the above two characteristics results as follows.
  - a. Open the *Qg (JESD24-2 High Id + JESD24-2 High Vds)* application test.
  - b. Set the *InCaseOfError* parameter to *Continue* to prevent an abort of the automatic test execution when an error occurs on a device test. You can set this in the Extended Setup dialog box opened by the *Extended Setup ...* button.
  - c. Specify an approximate expected total gate charge value to the *QgMaxXAxis* parameter and specify an expected threshold voltage to the *VgsTh* parameter.
  - d. Save this setup to the preset group created in Step 1.
5. Build up a test sequence in the Quick Test mode.

Click the *Quick Test* tab on the main screen. The tab is in the leftmost column on the screen.

The Quick Test screen lists the test setups created in steps 2 to 4.

If they are not listed according to the following order, change the order using the *Up/Down* buttons.





- a. *Qg (High Id + JESD24-2)*
- b. *Qg (High Vds + JESD24-2)*



- c. *Qg (JESD24-2 High Id + JESD24-2 High Vds)*

## Performing the Measurement

Since you need to change the DUT connections between the high current and high voltage gate charge measurements, perform the quick test twice as follows.

1. Set up the connections for high current gate charge measurement.
2. Perform the first quick test.
  - a. Turn on the execution flag (  mark) only for the first test setup *Qg (High Id + JESD24-2)* on the Quick Test screen.
  - b. Click the  Repeat button. This opens the Repeat Measurement Setup dialog box.
  - c. Specify the prober driver programs to be used to the *Start Procedure*, *Iteration Procedure*, and *Final Procedure* fields, and then check the *Automatically fill in Device ID*.
  - d. Uncheck the *Counter Reaching to* in the *Repeat Stop Condition* area.
  - e. Click the *Run* button to start the quick test.
3. Set up the connections for high voltage gate charge measurement.
4. Perform the second quick test.
  - a. Turn on the execution flag (  mark) for the test setups *Qg (High Vds + JESD24-2)* and *Qg (JESD24-2 High Id + JESD24-2 High Vds)* on the Quick Test screen.
  - b. Click the  Repeat button. This opens the Repeat Measurement Setup dialog box.
  - c. Specify the prober driver programs to be used to the *Start Procedure*, *Iteration Procedure*, and *Final Procedure* fields, and then check the *Automatically fill in Device ID*.
  - d. Uncheck the *Counter Reaching to* in the *Repeat Stop Condition* area.
  - e. Click the *Run* button to start the quick test.

---

### NOTE

The furnished prober driver programs return the X-Y coordinate data (die index) of device (chip), and each measurement uses it as Device ID. In Step 2 and 4, each measurement can use the same Device ID by using the same probing sequence.

---

**NOTE**

$Q_g$  (*JESD24-2 High Id + JESD24-2 High Vds*) (for extracting high current and high voltage gate charge characteristics) inquires the latest high current gate charge measurement result and the latest high voltage gate charge measurement result using the specified Device ID.

A maximum of 1000 measurement results for a Device ID can be recorded. They are kept until the present workspace is closed.

---

### Checking the Measurement Result

After each measurement, the gate charge characteristics will be displayed on the Data Display window. After all measurements, you can view each measurement result on the Data Display window.

The result of the  $Q_g$  (*JESD24-2 High Id + JESD24-2 High Vds*) shows the gate charge characteristics extracted from the high current and high voltage measurement results.

For the  $Q_g$  (*High Id + JESD24-2*) and  $Q_g$  (*High Vds + JESD24-2*), you can also observe the switching waveforms as shown below.

1. Click the *Results* button at the lower position of the main screen to show the pull-down menu, and then select *Filter > Expand Application Test Results* to activate this function.
2. Select a measurement result of the  $Q_g$  (*High Id Switching*) or  $Q_g$  (*High Vds Switching*) in the list of the *Results*. And then, right-click it to open the pop-up menu, and select the *Display Data*. The switching waveforms are displayed in the Data Display window.

### Adjusting the Measurement Condition

The charging interval on the gate charge characteristics increases in proportion to the switching speed. If the charge interval is too long, decrease the gate current  $I_g$ .

## On-Wafer Auto-Testing Using Resistive Load on the N1275A

### Preparing Measurement Setups

Used Application Tests:

- *Qg (R Load High Id + JESD24-2)*
  - *Qg (High Vds + JESD24-2)*
  - *Qg (JESD24-2 High Id + JESD24-2 High Vds)*
1. Create a new preset group.
  2. Create a test setup for high current gate charge measurement as follows.
    - a. Open the *Qg (R Load High Id + JESD24-2)* application test.
    - b. Set the *InCaseOfError* parameter to *Continue* to prevent an abort of the automatic test execution when an error occurs on a device test. You can set this in the Extended Setup dialog box opened by the *Extended Setup ...* button.
    - c. Specify an approximate expected total gate charge value to the *QgMaxXAxis* parameter and specify an expected threshold voltage to the *VgsTh* parameter.
    - d. Specify the On current to the *IdOn* parameter according to your switching condition. For the *VdsOff* parameter, specify the upper limit value to automatically search for the load voltage when the On current flows to the active DUT.
    - e. Specify the measurement range of the gate voltage using the *VgsOff* and *VgsOn* parameters.
    - f. Save this setup to the preset group created in Step 1.
  3. Create a test setup for high voltage gate charge measurement as follows.
    - a. Open the *Qg (High Vds + JESD24-2)* application test.
    - b. Set the *InCaseOfError* parameter to *Continue* to prevent an abort of the automatic test execution when an error occurs on a device test. You can set this in the Extended Setup dialog box opened by the *Extended Setup ...* button.
    - c. Specify an approximate expected total gate charge value to the *QgMaxXAxis* parameter and specify an expected threshold voltage to the *VgsTh* parameter.

## Measurement Examples

### Gate Charge Measurement

- d. Specify the Off voltage to the  $V_{dsOff}$  parameter according to your switching condition.
  - e. Specify the measurement range of the gate voltage using the  $V_{gsOff}$  and  $V_{gsOn}$  parameters.
  - f. Save this setup to the preset group created in Step 1.
4. Create a test setup for extracting the high current and high voltage gate charge characteristics from the above two characteristics results as follows.
    - a. Open the  $Q_g$  (*JESD24-2 High Id + JESD24-2 High Vds*) application test.
    - b. Set the *InCaseOfError* parameter to *Continue* to prevent an abort of the automatic test execution when an error occurs on a device test. You can set this in the Extended Setup dialog box opened by the *Extended Setup ...* button.
    - c. Specify an approximate expected total gate charge value to the  $Q_{gMaxXAxis}$  parameter and specify an expected threshold voltage to the  $V_{gsTh}$  parameter.
    - d. Save this setup to the preset group created in Step 1.
  5. Build up a test sequence in the Quick Test mode.

Click the *Quick Test* tab on the main screen. The tab is in the leftmost column on the screen.

The Quick Test screen lists the test setups created in steps 2 to 4.



If they are not listed according to the following order, change the order using the *Up/Down* buttons.

- a.  $Q_g$  (*R Load High Id + JESD24-2*)
- b.  $Q_g$  (*High Vds + JESD24-2*)
- c.  $Q_g$  (*JESD24-2 High Id + JESD24-2 High Vds*)

### Performing the Measurement

Since you need to change the DUT connections between the high current and high voltage gate charge measurements, perform the quick test twice as follows.

1. Set up the connections for high current gate charge measurement.
2. Perform the first quick test.
  - a. Turn on the execution flag ( mark) only for the first test setup  $Q_g$  (*R Load High Id + JESD24-2*) on the Quick Test screen.

- b. Click the  Repeat button. This opens the Repeat Measurement Setup dialog box.
  - c. Specify the prober driver programs to be used to the *Start Procedure*, *Iteration Procedure*, and *Final Procedure* fields, and then check the *Automatically fill in Device ID*.
  - d. Uncheck the *Counter Reaching to* in the *Repeat Stop Condition* area.
  - e. Click the *Run* button to start the quick test.
3. Set up the connections for high voltage gate charge measurement.
  4. Perform the second quick test.
    - a. Turn on the execution flag ( mark) for the test setups *Qg (High Vds + JESD24-2)* and *Qg (JESD24-2 High Id + JESD24-2 High Vds)* on the Quick Test screen.
    - b. Click the  Repeat button. This opens the Repeat Measurement Setup dialog box.
    - c. Specify the prober driver programs to be used to the *Start Procedure*, *Iteration Procedure*, and *Final Procedure* fields, and then check the *Automatically fill in Device ID*.
    - d. Uncheck the *Counter Reaching to* in the *Repeat Stop Condition* area.
    - e. Click the *Run* button to start the quick test.

---

**NOTE**

The furnished prober driver programs return the X-Y coordinate data (die index) of device (chip), and each measurement uses it as Device ID. In Step 2 and 4, each measurement can use the same Device ID by using the same probing sequence.

---

**NOTE**

*Qg (JESD24-2 High Id + JESD24-2 High Vds)* (for extracting high current and high voltage gate charge characteristics) inquires the latest high current gate charge measurement result and the latest high voltage gate charge measurement result using the specified Device ID.

A maximum of 1000 measurement results for a Device ID can be recorded. They are kept until the present workspace is closed.

---

## Checking the Measurement Result

After each measurement, the gate charge characteristics will be displayed on the Data Display window. After all measurements, you can view each measurement result on the Data Display window.

## Measurement Examples

### Gate Charge Measurement

The result of the  $Q_g$  (*JESD24-2 High Id + JESD24-2 High Vds*) shows the gate charge characteristics extracted from the high current and high voltage measurement results.

For the  $Q_g$  (*R Load High Id + JESD24-2*) and  $Q_g$  (*High Vds + JESD24-2*), you can also observe the switching waveforms as shown below.

1. Click the *Results* button at the lower position of the main screen to show the pull-down menu, and then select *Filter > Expand Application Test Results* to activate this function.
2. Select a measurement result of the  $Q_g$  (*High Id Switching*) or  $Q_g$  (*High Vds Switching*) in the list of the *Results*. And then, right-click it to open the pop-up menu, and select the *Display Data*. The switching waveforms are displayed in the Data Display window.

### **Adjusting the Measurement Condition**

The charging interval on the gate charge characteristics increases in proportion to the switching speed. If the charge interval is too long, decrease the gate current  $I_g$ .

## Available Application Test List

Category	Application Test	Description
PowerMOSFET	Qg (High Id + High Vds+ JESD24-2)	Performing high voltage gate charge measurement at the specified off voltage and high current gate charge measurement at the specified on current, and then extracting gate charge characteristics
	Qg (R Load High Id + High Vds+ JESD24-2)	Performing high voltage gate charge measurement at the specified off voltage and high current gate charge measurement at the resistive load, and then extracting gate charge characteristics
	Qg (High Id + High Vds)	Performing high voltage gate charge measurement at the specified off voltage and high current gate charge measurement at the specified on current
	Qg (R Load High Id + High Vds)	Performing high voltage gate charge measurement at the specified off voltage and high current gate charge measurement at the resistive load
	Qg (High Id + JESD24-2)	Performing high current gate charge measurements at the specified off voltage and on current, and then extracting gate charge characteristics
	Qg (R Load High Id + JESD24-2)	Performing high current gate charge measurements at the resistive load, and then extracting gate charge characteristics
	Qg (High Id)	Performing high current gate charge measurements at the specified off voltage and on current
	Qg (R Load High Id)	Performing high current gate charge measurements at the resistive load

Measurement Examples  
Gate Charge Measurement

<b>Category</b>	<b>Application Test</b>	<b>Description</b>
PowerMOSFET	Qg (High Vds + JESD24-2)	Performing high voltage gate charge measurement at the specified off voltage, and then extracting gate charge characteristics
	Qg (High Vds)	Performing high voltage gate charge measurement at the specified off voltage
	Qg (JESD24-2 High Id + JESD24-2 High Vds)	Extracting high current and high voltage gate charge characteristics from the results of high current and high voltage gate charge characteristics extraction that have the same Device ID.
IGBT	Qg (High Ic + High Vce+ JESD24-2)	Performing high voltage gate charge measurement at the specified off voltage and high current gate charge measurement at the specified on current, and then extracting gate charge characteristics
	Qg (R Load High Ic + High Vce+ JESD24-2)	Performing high voltage gate charge measurement at the specified off voltage and high current gate charge measurement at the resistive load, and then extracting gate charge characteristics
	Qg (High Ic + High Vce)	Performing high voltage gate charge measurement at the specified off voltage and high current gate charge measurement at the specified on current
	Qg (R Load High Ic + High Vce)	Performing high voltage gate charge measurement at the specified off voltage and high current gate charge measurement at the resistive load
	Qg (High Ic + JESD24-2)	Performing high current gate charge measurements at the specified off voltage and on current, and then extracting gate charge characteristics



Category	Application Test	Description
IGBT	Qg (R Load High Ic + JESD24-2)	Performing high current gate charge measurements at the resistive load, and then extracting gate charge characteristics
	Qg (High Ic)	Performing high current gate charge measurements at the specified off voltage and on current
	Qg (R Load High Ic)	Performing high current gate charge measurements at the resistive load
	Qg (High Vce + JESD24-2)	Performing high voltage gate charge measurement at the specified off voltage, and then extracting gate charge characteristics
	Qg (High Vce)	Performing high voltage gate charge measurement at the specified off voltage
	Qg (JESD24-2 High Ic + JESD24-2 High Vce)	Extracting high current and high voltage gate charge characteristics from the results of high current and high voltage gate charge characteristics extraction that have the same Device ID.
N1274A	IV Path (N1274A)	Making IV measurement path in the N1274A

## I-V and Capacitance Measurements Using N1272A

This section introduces the Power MOSFET Ciss (input capacitance) and IDSS (drain-source leak current) measurement examples with controlling the N1272A Device Capacitance Selector and consists of the following sub-sections.

- “Preparing Measurement”
- “System Configuration and Open/Short Calibration”
- “Preparing Capacitance Measurement Setups”
- “Performing Capacitance Measurement”
- “Preparing IV Measurement Setups”
- “Performing IV Measurement”
- “Available Application Test List”

### Preparing Measurement

---

**WARNING**

Set the instrument output off before connecting or disconnecting a connection wire.

Press the B1505A front panel Stop key to set the output off. And confirm that the B1505A front panel High Voltage indicator is not lit.

Désactivez la sortie de l'appareil avant de brancher ou de débrancher un câble de connexion.

Appuyez sur la touche Stop du panneau avant du B1505A pour désactiver la sortie. Et confirmez que l'indicateur de tension High du panneau avant du B1505A n'est pas allumé.

---

**WARNING**



To prevent electrical shock and DUT damage, do not connect or disconnect the DUT while the instrument is applying voltage or current.

When you touch the DUT after measurement, devise a countermeasure of residual charge and heat to prevent electrical shock and burn. Use gloves and any tool. Also have enough time for discharge and radiation.

Afin d'éviter toute décharge électrique et dommage MST, ne branchez ou débranchez pas la sortie MST alors que l'appareil envoie de la tension ou du courant.

Lorsque vous touchez le MST après la mesure, élaborer une contre-mesure de la charge résiduelle et du chauffage afin d'éviter tout choc électrique et toute brûlure. Utilisez des gants et des outils. Prévoyez également du temps pour la décharge et la radiation.

Prepare a measurement as follows:

1. Connect the test fixture, the socket module, and the required accessories.

For more information, see the following sections:

- “N1272A Device Capacitance Selector” on page 3-83
- “N1273A Capacitance Test Fixture” on page 3-87

The GNDU and the Interlock must be connected to the test fixture or the prober station actually used for the measurement. See [Table 5-1](#) for the capacitance measurement connection, and see [Table 5-2](#) for the IV measurement connection.

2. Prepare a DUT (device under test).
3. Turn the N1272A selector on, and then turn the B1505A on.  
Do not connect the device at this time.

**Table 5-1 Connections for the Capacitance Measurement**

B1505A	Cable	N1272A		Cable	N1273A or Prober Station
		Input Terminal	Output Terminal		Input Terminal
GNDU	GNDU Cable	GNDU			
Interlock	Interlock Cable	Interlock	Interlock	Interlock Cable	Interlock

**Table 5-2**                      **Connections for the IV Measurement**

<b>B1505A</b>	<b>Cable</b>	<b>N1265A</b>
<b>Output Terminal</b>		<b>Input Terminal</b>
GNDU	GNDU Cable	GNDU
Interlock	Interlock Cable	Interlock

## System Configuration and Open/Short Calibration

Select selector and measurement resources used for the measurement, and then measure the Open and Short calibration data of all capacitance measurement paths including the DUT interface as follows.

1. Click the *Configuration* button in the EasyEXPERT main window.  
The Configuration window appears.
2. Click the *Device Capacitance Selector* tab to display the Device Capacitance Selector tab screen.
3. Set up the Device Capacitance Selector and select the used measurement resources.

---

### **NOTE**

---

To set up an I-V measurement using the IV path of the N1272A Device Capacitance Selector, select IV in the Default Path field.

4. Click the Start Calibration... button to measure the calibration data of measurement path. The Device Capacitance Calibration dialog box appears.  
  
If you have measured and saved the calibration data of measurement path, click the *Select Calibration Data...* button to select and load the stored calibration data. Go to the step 7.
5. Click the *Start* button.  
  
Follow the instruction displayed on the dialog to measure the open and short calibration data.  
  
It will take about 20 minutes to obtain the calibration data.
6. After finishing the calibration, click the *Save and Apply* button to save and apply the calibration data.
7. Click the *Close* button to close the dialog box.

8. Click the *Apply* button to apply the present settings, and then click the *Close* button to close the Configuration window.

## Preparing Capacitance Measurement Setups

This section shows an example of the setup procedure for the Power MOSET Ciss (input capacitance) measurement using the N1272A Selector.

Prepare measurement setups as follows:

1. Click the *Application Test* tab on the main screen. The tab is in the leftmost column on the screen.
2. Check the *PowerMOSET* in the Category field. The Library field lists the test conditions.
3. Click the *Ciss (N1272A)* in the Library field and *Select* button sequentially. The screen changes the display for setting up the Ciss (N1272A).
4. Set up the minimum and maximum values of Ciss at the Device Parameters field.
5. Set up the measurement conditions at the Test Parameters field.
  - a. Enter the measurement frequency in the *Frequency*.
  - b. Enter the gate-source bias voltage value in the *Gate*.
  - c. Enter or select the drain-source voltage sweep conditions in the *Drain*.
  - d. Set up the other parameters if necessary.

For details of the setting parameters, see the help message for each test definition.

## Measurement Examples

### I-V and Capacitance Measurements Using N1272A

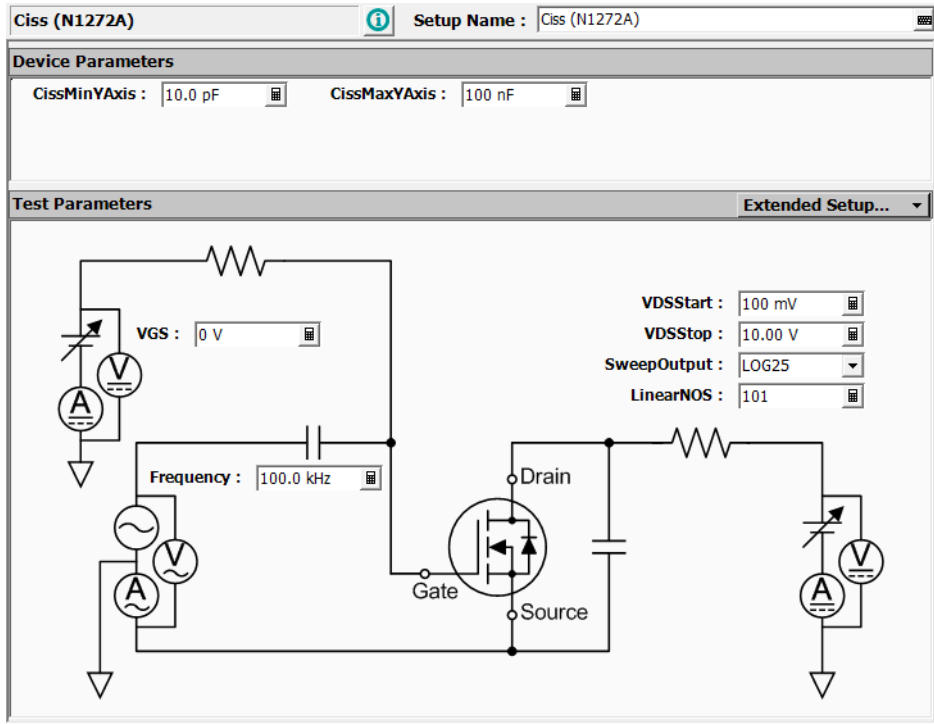

## Performing Capacitance Measurement

1. Set your DUT on the test fixture.
2. Click the  Single button to start measurement. This opens the Data Display window.

The withstand voltage of DUT is checked, the measurement path is switched, the calibration data is applied, and then the measurement is performed.

After the measurement, the measurement data is displayed on the Data Display window.

## Preparing IV Measurement Setups

This section shows an example of the setup procedure for the Power MOSFET IDSS (drain-source leak current) measurement using the N1272A Selector.

Prepare measurement setups as follows:

1. Click the *Application Test* tab on the main screen. The tab is in the leftmost column on the screen.
2. Check the *PowerMOSFET* in the Category field. The Library field lists the test conditions.
3. Click the *IDSS* in the Library field and *Select* button sequentially. The screen changes the display for setting up the IDSS.
4. Set up the minimum and maximum values and the scale of IDSS at the Device Parameters field.
5. Set up the measurement conditions at the Test Parameters field.
  - a. Enter the gate-source bias voltage value in the *Gate*.
  - b. Enter or select the drain-source voltage sweep conditions in the *Drain*.
  - c. Set up the other parameters if necessary.

For details of the setting parameters, see the help message for each test definition.

## Measurement Examples

### I-V and Capacitance Measurements Using N1272A

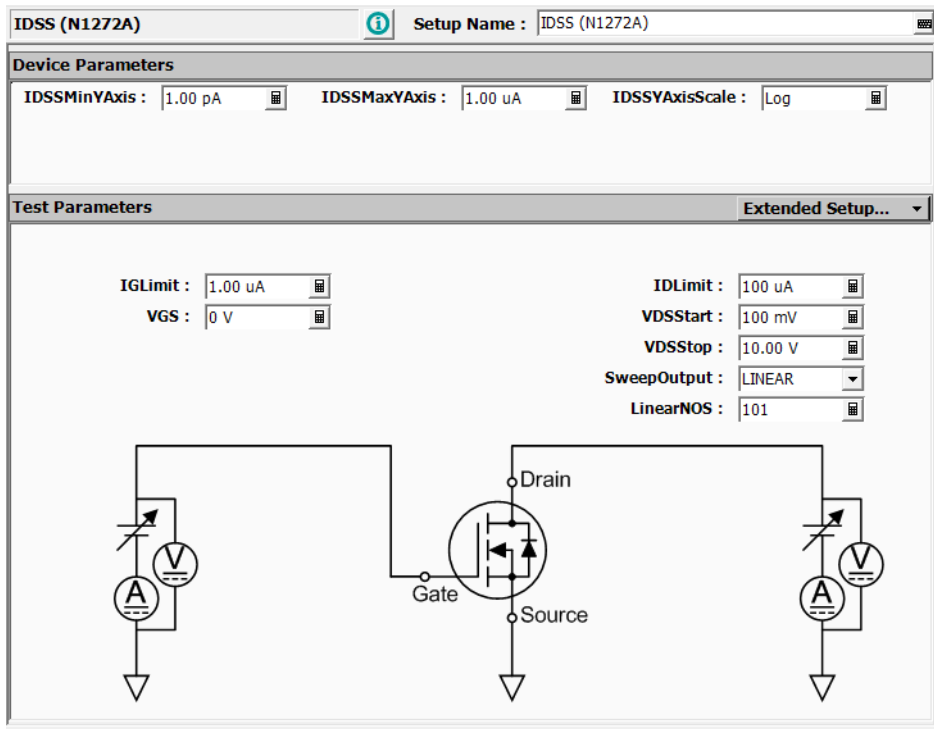

## Performing IV Measurement

1. Set your DUT on the test fixture.
2. Click the  Single button to start measurement. This opens the Data Display window.

The measurement path is switched before the measurement is performed.

After the measurement, the measurement data is displayed on the Data Display window.



## Available Application Test List

- For capacitance measurements:

Category	Application Test	Description
PowerMOSFET	Ciss (N1272A)	Input capacitance measurement
	Coss (N1272A)	Output capacitance measurement
	Crss (N1272A)	Feedback capacitance measurement
	Cgs (N1272A)	Gate-Source capacitance measurement
	Cds (N1272A)	Drain-Source capacitance measurement
	Cgd (N1272A)	Gate-Drain capacitance measurement
	Rg (N1272A) for PowerMOSFET	Gate resistance measurement
	Ciss-Vgs (N1272A)	Input capacitance measurement (Gate-Source voltage sweep)
IGBT	Cies (N1272A)	Input capacitance measurement
	Coes (N1272A)	Output capacitance measurement
	Cres (N1272A)	Feedback capacitance measurement
	Cge (N1272A)	Gate-Emitter capacitance measurement
	Cce (N1272A)	Collector-Emitter capacitance measurement
	Cgc (N1272A)	Gate-Collector capacitance measurement
	Rg (N1272A) for IGBT	Gate resistance measurement
	Cies-Vge (N1272A)	Input capacitance measurement (Gate-Emitter voltage sweep)
PowerDiode	CT	Total capacitance measurement

Measurement Examples  
I-V and Capacitance Measurements Using N1272A

- For I-V measurements:

<b>Category</b>	<b>Application Test</b>	<b>Description</b>
PowerMOSFET	IDSS	Drain- Source leak current measurement
	IGSS	Gate-Source leak current measurement
IGBT	ICES	Collector-Emitter leak current measurement
	IGES	Gate-Emitter leak current measurement
PowerDiode	IR	Inverse current/leak current measurement
N1272A	IV Path (N1272A)	Making IV measurement path in the N1272A

---

## Temperature Controlled by Thermal Plate

This section introduces a measurement example with the ambient temperature control realized by the EasyEXPERT built-in application tests which support the inTEST thermal plate.

This measurement is realized by using the Quick Test. Create and save the test setups for temperature control and the test setup for measurement in a preset group (My Favorite) and define the execution order in the quick test. Temperature control and measurement are automatically executed by running this quick test.

This section consists of the following sub-sections:

- “Preparing Measurement”
- “Preparing Temperature Control and Measurement Setups”
- “Performing Temperature Control and Measurement”
- “Available Application Test List”

### Preparing Measurement

---

#### WARNING



Set the instrument output off before connecting or disconnecting a connection wire.

Press the B1505A front panel Stop key to set the output off. And confirm that the B1505A front panel High Voltage indicator is not lit.

Désactivez la sortie de l'appareil avant de brancher ou de débrancher un câble de connexion.

Appuyez sur la touche Stop du panneau avant du B1505A pour désactiver la sortie. Et confirmez que l'indicateur de tension High du panneau avant du B1505A n'est pas allumé.

---

---

**WARNING**

**To prevent electrical shock and DUT damage, do not connect or disconnect the DUT while the instrument is applying voltage or current.**

**When you touch the DUT after measurement, devise a countermeasure of residual charge and heat to prevent electrical shock and burn. Use gloves and any tool. Also have enough time for discharge and radiation.**

**Afin d'éviter toute décharge électrique et dommage MST, ne branchez ou débranchez pas la sortie MST alors que l'appareil envoie de la tension ou du courant.**

**Lorsque vous touchez le MST après la mesure, élaborer une contre-mesure de la charge résiduelle et du chauffage afin d'éviter tout choc électrique et toute brûlure. Utilisez des gants et des outils. Prévoyez également du temps pour la décharge et la radiation.**

---

Prepare a measurement as follows:

1. Connect the test fixture, the socket module, and the required accessories.  
For more information, see the following sections:
  - [“N1259A Test Fixture” on page 3-9](#)
  - [“N1265A Ultra High Current Expander/Fixture” on page 3-33](#)
  - [“N1271A-001 Thermal Plate Compatible Enclosure for N1259A/N1265A” on page 3-71](#)
2. Set up the thermal plate and the N1271A-001 enclosure on the N1259A or N1265A test fixture.
3. Connect a GPIB cable between the controller (B1505A or external PC) and the thermal plate.
4. Prepare a DUT (device under test).
5. Turn the instrument on.  
Do not connect the device at this time.
6. Perform the GPIB settings for controlling the thermal plate.
  - Set the GPIB interface on the controller (B1505A or external PC) as “System Controller”.
  - Check the GPIB addresses on the controller and the thermal plate. If they are duplicated, set unique addresses.

## Preparing Temperature Control and Measurement Setups

---

**NOTE**

---

You can create test setups in random order. This section describes it in the order of the test sequence.

1. Create a new preset group.
  - a. Click the *My Favorite* button on the EasyEXPERT main screen, and then select *New...* A dialog box appears.
  - b. Enter a name of the new preset group, and then click *OK*.  
The new preset group name is displayed under the *My Favorite* button.

2. Create a test setup for initializing the thermal plate.

Create a test setup using the *ThermalPlate Initialize* application test, and save it to the preset group created in Step 1.

Application tests for temperature control belong to the Thermal category.

3. Create a test setup for setting up the operation parameters of the thermal plate.

Create a test setup using the *ThermalPlate DefineParameters* application test, and save it to the preset group created in Step 1.

4. Create a test setup for controlling the temperature of the thermal plate.

Create a test setup using the *ThermalPlate ControlTemperature* application test, and save it to the preset group created in Step 1.

The following example sets the target temperature to 25 °C, and the temperature slew rate to 60 °C/min.

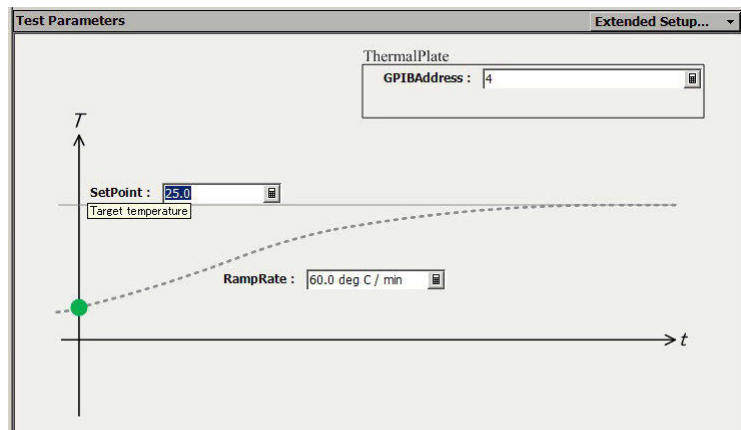

Measurement Examples  
Temperature Controlled by Thermal Plate

5. Create a test setup for setting up the wait time and the temperature monitor.

If the thermometer of the thermal plate is used for the temperature monitor, create a test setup using the *ThermalPlate WaitTemperature* application test and save it to the preset group created in Step 1.

If the thermocouple connected to N1265A is used for the temperature monitor, create a test setup using the *N1265A WaitTemperature* application test and save it to the preset group created in Step 1.

The following example sets the target temperature range to  $25\text{ }^{\circ}\text{C} \pm 1\text{ }^{\circ}\text{C}$ , the hold time to 4 seconds, the temperature monitor interval to 2 seconds, and the soak time to 5 seconds.

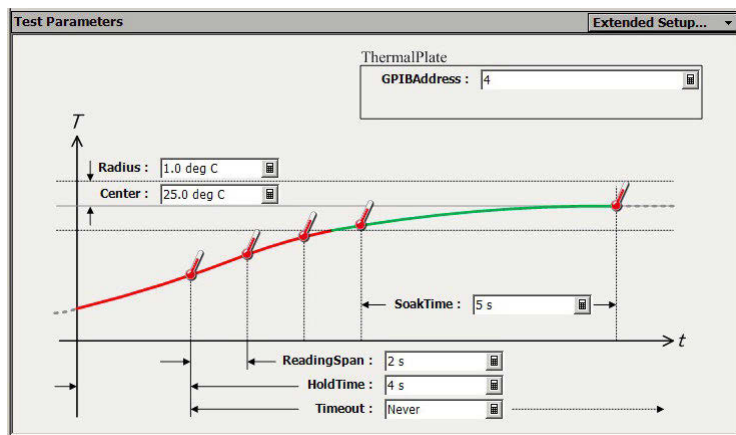

6. Create a test setup for measurement.  
Create a test setup using the desired classic test or application test, and save it to the preset group created in Step 1.
7. Repeat steps 4, 5, and 6 as much as the number of the temperature conditions.
8. Create a test setup for controlling the temperature of the thermal plate to the ordinary temperature.  
Create a test setup using the *ThermalPlate ControlTemperature* application test, and save it to the preset group created in Step 1.
9. Define the test setup execution order in the quick test.

Click the *Quick Test* tab on the main screen. The tab is in the leftmost column on the screen.

The Quick Test screen lists the test setups created in steps 2 to 8.

If they are not listed according to the following order, change the order using the *Up/Down* buttons.

- a. ThermalPlate Initialize (for initialization)
- b. ThermalPlate DefineParameters (for setting up the operation parameters)
- c. ThermalPlate ControlTemperature (for controlling the temperature)
- d. ThermalPlate WaitTemperature or N1265A WaitTemperature (for waiting)
- e. A device test setup
- f. Repeating of steps c, d, and e
- g. ThermalPlate ControlTemperature (for ordinary temperature)

## Performing Temperature Control and Measurement

1. Set your DUT on the thermal plate, and make the connections.
2. Set the hood of the N1271A-001 enclosure on the test fixture properly.
3. Click the  Single button to start Quick Test. This opens the Data Display window.

A temperature at the measurement is added to the Device ID.

---

### WARNING



**The thermal plate may become high temperature up to +250 °C. To prevent yourself from getting injured, confirm that it is in the safe temperature range before touching it.**

**La plaque de température pourrait devenir la haute température à +250 degré Celsius. D'être blessés avant de toucher la plaque confirmez s'il vous plaît que deviennent la température sûre pour qu'il n'y ait pas cela.**

## Available Application Test List

<b>Category</b>	<b>Application Test</b>	<b>Description</b>
Thermal	N1265A WaitTemperature	Setting up the wait time and the temperature monitor by the N1265A built-in thermometer
	ThermalPlate ControlTemperature	Temperature controlling by thermal plate
	ThermoPlate DefineParameters	Setting up the thermal plate operation parameters
	ThermoPlate Initialize	Initializing the thermal plate
	ThermoPlate ReadTemperature	Reading the thermometer on the thermal plate
	ThermoPlate WaitTemperature	Setting up the wait time and the temperature monitor by the thermal plate built-in thermometer



---

## Temperature Controlled by ThermoStream

This section introduces a measurement example with the ambient temperature control realized by the EasyEXPERT built-in application tests which support the inTEST ThermoStream.

This measurement is realized by using the Quick Test. Create and save the test setups for temperature control and the test setup for measurement in a preset group (My Favorite) and define the execution order in the quick test. Temperature control and measurement are automatically executed by running this quick test.

This section consists of the following sub-sections:

- “Preparing Measurement”
- “Preparing Temperature Control and Measurement Setups”
- “Performing Temperature Control and Measurement”
- “Available Application Test List”

### Preparing Measurement

---

#### WARNING



Set the instrument output off before connecting or disconnecting a connection wire.

Press the B1505A front panel Stop key to set the output off. And confirm that the B1505A front panel High Voltage indicator is not lit.

Désactivez la sortie de l'appareil avant de brancher ou de débrancher un câble de connexion.

Appuyez sur la touche Stop du panneau avant du B1505A pour désactiver la sortie. Et confirmez que l'indicateur de tension High du panneau avant du B1505A n'est pas allumé.

---

---

**WARNING**

**To prevent electrical shock and DUT damage, do not connect or disconnect the DUT while the instrument is applying voltage or current.**

**When you touch the DUT after measurement, devise a countermeasure of residual charge and heat to prevent electrical shock and burn. Use gloves and any tool. Also have enough time for discharge and radiation.**

**Afin d'éviter toute décharge électrique et dommage MST, ne branchez ou débranchez pas la sortie MST alors que l'appareil envoie de la tension ou du courant.**

**Lorsque vous touchez le MST après la mesure, élaborer une contre-mesure de la charge résiduelle et du chauffage afin d'éviter tout choc électrique et toute brûlure. Utilisez des gants et des outils. Prévoyez également du temps pour la décharge et la radiation.**

---

Prepare a measurement as follows:

1. Connect the test fixture, the socket module, and the required accessories.

For more information, see the following sections:

- [“N1265A Ultra High Current Expander/Fixture” on page 3-33](#)
- [“N1271A-002 ThermoStream Compatible Enclosure for N1265A \(3kV IV\)” on page 3-73](#)
- [“N1271A-005 ThermoStream Compatible Enclosure for N1265A \(3kV IV, CV & 10kV\)” on page 3-78](#)

2. Set up the N1271A-002 or -005 enclosure on the N1265A test fixture.
3. Connect a GPIB cable between the controller (B1505A or external PC) and the ThermoStream.
4. Prepare a DUT (device under test).
5. Turn the instrument on.  
Do not connect the device at this time.
6. Perform the GPIB settings for controlling the ThermoStream.
  - Set the GPIB interface on the controller (B1505A or external PC) as “System Controller”.
  - Check the GPIB addresses on the controller and the ThermoStream. If they are duplicated, set unique addresses.

## Preparing Temperature Control and Measurement Setups

---

**NOTE**

---

You can create test setups in random order. This section describes it in the order of the test sequence.

1. Create a new preset group.
  - a. Click the *My Favorite* button on the EasyEXPERT main screen, and then select *New...* A dialog box appears.
  - b. Enter a name of the new preset group, and then click *OK*.  
The new preset group name is displayed under the *My Favorite* button.

2. Create a test setup for initializing the ThermoStream.

Create a test setup using the *ThermoStream Initialize* application test, and save it to the preset group created in Step 1.

Application tests for temperature control belong to the Thermal category.

3. Create a test setup for setting up the operation parameters of the ThermoStream.

Create a test setup using the *ThermoStream DefineParameters* application test, and save it to the preset group created in Step 1.

4. Create a test setup for controlling the temperature of the ThermoStream airflow.

Create a test setup using the *ThermoStream ControlTemperature* application test, and save it to the preset group created in Step 1.

The following example sets the target temperature to 25 °C and the temperature slew rate to 60 °C/min.

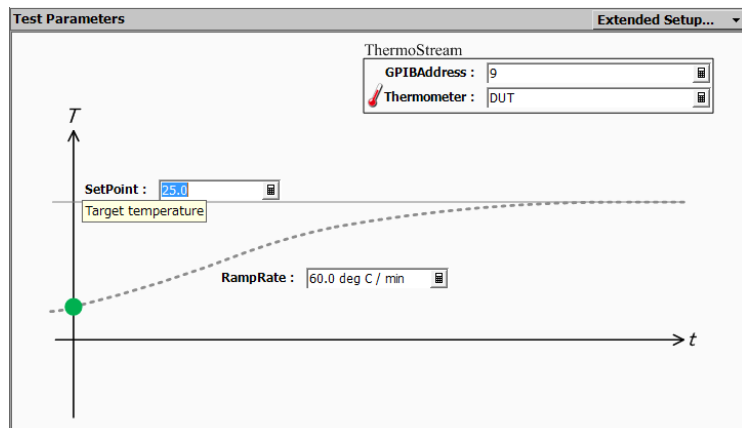

Measurement Examples  
Temperature Controlled by ThermoStream

**NOTE**

Thermometer: Set the operation mode, Air or DUT, of ThermoStream.

5. Create a test setup for setting up the wait time and the temperature monitor.

If the thermometer of the ThermoStream is used for the temperature monitor, create a test setup using the *ThermoStream WaitTemperature* application test and save it to the preset group created in Step 1.

If the thermocouple connected to N1265A is used for the temperature monitor, create a test setup using the *N1265A WaitTemperature* application test and save it to the preset group created in Step 1.

The following example sets the target temperature range to  $25\text{ }^{\circ}\text{C} \pm 1\text{ }^{\circ}\text{C}$ , the hold time to 4 seconds, the temperature monitor interval to 2 seconds, and the soak time to 5 seconds.

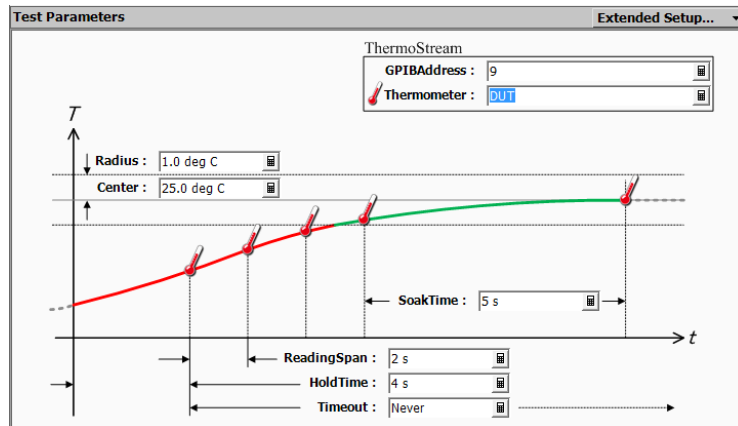

6. Create a test setup for measurement.

Create a test setup using the desired classic test or application test, and save it to the preset group created in Step 1.

7. Repeat steps 4, 5, and 6 as much as the number of the temperature conditions.
8. Create a test setup for controlling the temperature of the ThermoStream airflow to the ordinary temperature.

Create a test setup using the *ThermoStream ControlTemperature* application test, and save it to the preset group created in Step 1.

9. Create a test setup for stopping the ThermoStream airflow.

Create a test setup using the *ThermoStream FlowOff* application test, and save it to the preset group created in Step 1.

10. Define the test setup execution order in the quick test.

Click the *Quick Test* tab on the main screen. The tab is in the leftmost column on the screen.

The Quick Test screen lists the test setups created in steps 2 to 9.

If they are not listed according to the following order, change the order using the *Up/Down* buttons.

- a. ThermoStream Initialize (for initialization)
- b. ThermoStream DefineParameters (for setting up the operation parameters)
- c. ThermoStream ControlTemperature (for controlling the airflow temperature)
- d. ThermoStream WaitTemperature or N1265A WaitTemperature (for waiting)
- e. A device test setup
- f. Repeating of steps c, d, and e
- g. ThermoStream ControlTemperature (for ordinary temperature)
- h. ThermoStream FlowOff (for stopping the airflow)

## Performing Temperature Control and Measurement

1. Set your DUT into the N1271A-002 or -005 enclosure, and make the connections.
2. Adjust the head position of the ThermoStream for the top cover surface of the N1271A-002 or -005 enclosure, and then dock the ThermoStream with the enclosure.
3. Click the  Single button to start Quick Test. This opens the Data Display window.

A temperature at the measurement is added to the Device ID.

---

### WARNING



**Activating the Thermostream may cause low or high temperature of  $-50\text{ }^{\circ}\text{C}$  to  $+220\text{ }^{\circ}\text{C}$  on the enclosure front panel, the cover, and the left and right protection panels. To prevent yourself from getting injured, confirm that they are in the safe temperature range before touching the enclosure.**

**L'activation du flux thermique peut entraîner une basse ou haute température de -50 °C à +250 °C sur le panneau de protection avant, le couvercle et les panneaux de protection à gauche et à droite. Pour éviter de vous blesser, confirmez qu'ils sont dans la plage de température de sécurité avant de toucher le boîtier.**

---

## Available Application Test List

Category	Application Test	Description
Thermal	N1265A WaitTemperature	Setting up the wait time and the temperature monitor by the N1265A built-in thermometer
	ThermoStream ControlTemperature	Temperature controlling by ThermoStream
	ThermoStream DefineParameters	Setting up the ThermoStream operation parameters
	ThermoStream FlowOff	Stopping the ThermoStream airflow
	ThermoStream Initialize	Initializing the ThermoStream
	ThermoStream ReadTemperature	Reading the thermometer on the ThermoStream
	ThermoStream WaitTemperature	Setting up the wait time and the temperature monitor by the ThermoStream built-in thermometer

## Using Multiple HVSMU Modules

This section describes how to perform source output and measurement using the B1505A installed with multiple HVSMU modules.

- “HVSMU Output Range”
- “Setting Output Range Mode”
- “Performing Measurement”
- “Available Application Test List”

### HVSMU Output Range

If the B1505A is installed with multiple HVSMU modules, specify the output range mode first to enable the HVSMU. The following lists the available modes.

- Single channel mode (initial setting)  
An HVSMU channel is available. The other HVSMUs work as the channels of 0 V output with 4 mA compliance.
- $\pm 1500$  V mode  
The output range of all HVSMUs is from  $-1500$  V to 0 V and from  $-8$  mA to 0 mA, or from 0 V to  $+1500$  V and from 0 mA to  $+8$  mA.
- $+3000$  V mode  
The output range of all HVSMUs is from 0 V to  $+3000$  V and from 0 mA to  $+4$  mA.
- $-3000$  V mode  
The output range of all HVSMUs is from  $-3000$  V to 0 V and from  $-4$  mA to 0 mA.

## Setting Output Range Mode



You can set the output range mode of the HVSMU by either of the following:

- Performing the HVSMUOP command using the classic test *Direct Control*
- Performing the setup using the application test *Switch HVSMU Output Mode*

For the HVSMUOP command, see Keysight B1500 *Programming Guide*.

The application test *Switch HVSMU Output Mode* belongs to the *MultiHVSMU* category. For details of this application test, see the help message for each test definition.

## Performing Measurement

1. Open the application test *Switch HVSMU Output Mode*, and specify the output range mode.
2. Click the  Single button to set up the HVSMU output range mode.
3. Open the test definition or setup for a measurement, and specify the measurement conditions.
4. Click the  Single button to start the measurement.

Automation from the mode setup to the measurement is available by using the Quick Test.

If the output setting in your test setup is over the output range of the specified mode, the error 105001 occurs during the measurement. In this case, check the measurement condition and set the output range mode and the condition properly.

## Available Application Test List

Category	Application Test	Description
MultiHVSMU	Switch HVSMU Output Mode	Switching HVSMUs output range mode





This information is subject to change without notice.  
© Keysight Technologies 2009-2016  
Edition 12, January 2016

