

INSTRUCTION MANUAL

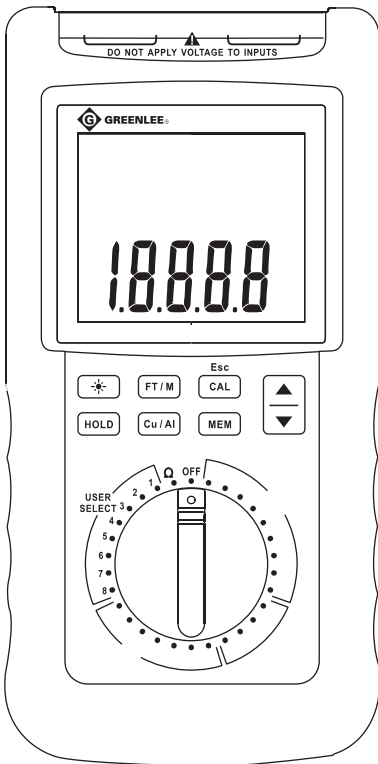

CLM-1000 CLM-1000E

Cable Length Meters



99 Washington Street
Melrose, MA 02176
Phone 781-665-1400
Toll Free 1-800-517-8431

 Visit us at www.TestEquipmentDepot.com

Description

The Greenlee CLM-1000 and CLM-1000E Cable Length Meters are hand-held testing devices with the following measurement capabilities: resistance, temperature, and length. They can be used as $\mu\Omega$ meters to measure precise bonding resistances. The primary function of these meters is to calculate the length of cable based upon its material, temperature, and cable gauge. Cable material type can be either uncoated copper or aluminum. There are 20 pre-programmed and eight programmable cable gauges. (There are no strands per cable specification for the eight programmable switch positions.)

The pre-programmed switch positions for the CLM-1000 are:

- AWG (7 strands) – 2, 4, 6, 8, 10, 12, 14, 16, 18
- Aught (19 strands) – 1/0, 2/0, 3/0, 4/0
- kcmil (37 strands) – 250, 350, 400, 500
- kcmil (61 strands) – 600, 750, 1000

The pre-programmed switch positions for the CLM-1000E are:

- mm² (7 strands) – 0.75, 1, 1.5, 2.5, 4, 6, 10, 16, 25, 35
- mm² (19 strands) – 50, 70, 95
- mm² (37 strands) – 120, 150, 185, 240
- mm² (61 strands) – 300, 400, 500

Other capabilities include:

- Automatic temperature compensation
- Hold Mode to capture the present LCD value
- Programmable
- Auto Power Off
- Automatic ranging
- Backlight

Safety

Safety is essential in the use and maintenance of Greenlee tools and equipment. This instruction manual and any markings on the tool provide information for avoiding hazards and unsafe practices related to the use of this tool. Observe all of the safety information provided.

Purpose of this Manual

This manual is intended to familiarize all personnel with the safe operation and maintenance procedures for the Greenlee CLM-1000 and CLM-1000E.

Keep this manual available to all personnel.

Replacement manuals are available upon request at no charge at www.greenlee.com.



Do not discard this product or throw away!

All specifications are nominal and may change as design improvements occur. Greenlee Textron Inc. shall not be liable for damages resulting from misapplication or misuse of its products.

® Registered: The color green for electrical test instruments is a registered trademark of Textron Innovations Inc.

KEEP THIS MANUAL

Important Safety Information



SAFETY ALERT SYMBOL

This symbol is used to call your attention to hazards or unsafe practices which could result in an injury or property damage. The signal word, defined below, indicates the severity of the hazard. The message after the signal word provides information for preventing or avoiding the hazard.

DANGER

Immediate hazards which, if not avoided, **WILL** result in severe injury or death.

WARNING

Hazards which, if not avoided, **COULD** result in severe injury or death.

CAUTION

Hazards or unsafe practices which, if not avoided, **MAY** result in injury or property damage.

WARNING

Electric shock and fire hazard:

- Do not connect this unit to live voltage.
- Do not expose this unit to rain or moisture.
- Do not use the unit if it is wet or damaged.
- Using this unit near equipment that generates electromagnetic interference can result in unstable or inaccurate readings.
- Inspect the test leads or accessory before use. They must be clean and dry, and the insulation must be in good condition.
- Use this unit for the manufacturer's intended purpose only, as described in this manual. Any other use can impair the protection provided by the unit.

Failure to observe these warnings could result in severe injury or death.

WARNING

Electric shock hazard:

- Do not operate with the case open.
- Before opening the case, remove the test leads from the circuit and shut off the unit.

Failure to observe these warnings could result in severe injury or death.

CAUTION

Electric shock hazard:

- Do not attempt to repair this unit. It contains no user-serviceable parts.
- Do not expose the unit to extremes in temperature or high humidity. Refer to "Specifications."

Failure to observe these precautions may result in injury and can damage the unit.



WARNING

Read and understand this material before operating or servicing this equipment. Failure to understand how to safely operate this tool could result in an accident causing serious injury or death.



WARNING

Electric shock hazard:
Contact with live circuits could result in severe injury or death.

Identification

1. Input terminals, two per Kelvin clips for a total of four terminals
2. LCD
3. Refer to explanation under “Using the Features.”
4. Rotary switch
5. Refer to explanation under “Using the Features.”

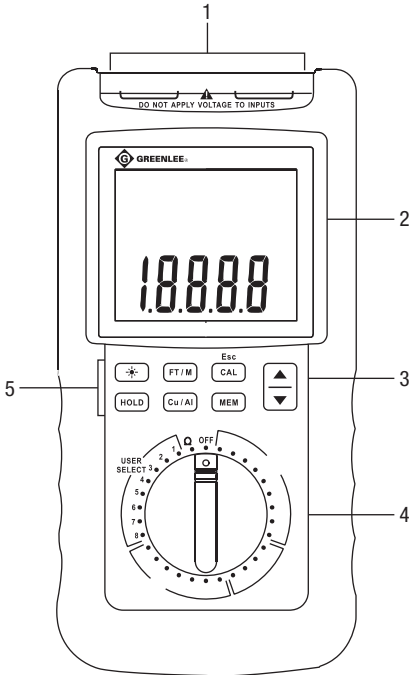

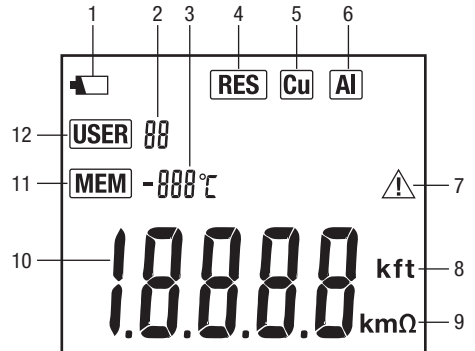

Display Icons

1. Low battery indicator
2. User-selected switch position
3. Ambient temperature indication
4. Resistance Mode
5. Copper
6. Aluminum
7. Caution: Out of temperature range
8. k – kilo, ft – feet
9. k – kilo + m – meter or m – milli + Ω – ohms
10. Numeric display
11. Memory location
12. User-selected programming mode



Symbols on the Unit

-  Warning—Read the instruction manual
-  Warning—Risk of electric shock
-  Double insulation

Using the Features

- : Press momentarily to turn the backlight ON. Once lit, press button again to turn the backlight OFF. The backlight automatically turns OFF after approximately 30 seconds to extend battery life.
- **FT/M**: Press momentarily to select length measurement units. On the LCD, “ft” indicates feet and “m” indicates meters.
- **CAL**: The meter must be calibrated each time it is turned ON. Refer to “Operation” for a complete description of the calibration process.
- **Esc**: Press to escape from programming process.
- **MEM**: Button is used for the user-selected programming function. Refer to “Operation” for a complete description of the programming process.
- **Cu/Al**: Press momentarily to select cable material. On the LCD, “Cu” indicates copper and “Al” indicates aluminum.
- **HOLD**: Press momentarily to enter data hold mode. When button is pressed, “dH” is present on the LCD and the current value is captured. To exit this mode, press the **HOLD**, **FT/M** or **Cu/Al** button. “dH” is no longer present on the LCD.
- **Auto Power Off (APO)**: When enabled, the meter will automatically turn OFF after 10 minutes of inactivity. Inactivity is defined as no button press or rotary switch movement. The buzzer sounds three times approximately 30 seconds before the meter turns OFF as a warning. To disable APO, press and hold the **HOLD** button while turning the meter ON.
- **▼▲**: Used during the user-selected programming process. Refer to “Operation” for a complete description of the programming process.

Programmable Switch Positions User’s Table

Use this table to keep track of the cable size that has been programmed into a switch position. Make annotations with something erasable because switch positions can be reprogrammed.

Switch Position	Gauge				Material Type	
	Size	Type (circle)				
1		mm ²	AWG	kcmil	aught	Cu or Al
2		mm ²	AWG	kcmil	aught	Cu or Al
3		mm ²	AWG	kcmil	aught	Cu or Al
4		mm ²	AWG	kcmil	aught	Cu or Al
5		mm ²	AWG	kcmil	aught	Cu or Al
6		mm ²	AWG	kcmil	aught	Cu or Al
7		mm ²	AWG	kcmil	aught	Cu or Al
8		mm ²	AWG	kcmil	aught	Cu or Al

Operation

	<h3>⚠ WARNING</h3>
	<p>Electric shock hazard: Do not connect the unit to live voltage. Contact with live circuits could result in severe injury or death.</p>

Calibration Procedure

Each time the meter is turned ON, it should be calibrated before use.

1. Refer to “Typical Measurements” for calibration setup diagram.
2. Ensure the calibration bar and Kelvin clips jaws are clean.
3. Move rotary switch from the **OFF** position to Ω .
4. Ensure that both leads for the red set of Kelvin clips are plugged into the red terminals on the meter.
Ensure that both leads for the black set of Kelvin clips are plugged into the black terminals on the meter.
5. Place each Kelvin clip on the calibration bar. Move the clips as close together as possible.
6. Press the **CAL** button. Dashes appear on the LCD. Next “MEM” and “donE” appear on the LCD. Then “RES” on the LCD indicates the meter is back in resistance mode. If “FAIL” appears on the LCD and the buzzer sounds, there was an issue with the calibration process. Turn meter OFF and return to step 1 of this procedure.
7. After successful completion of the calibration process, the meter is ready for normal operation.

Operating Procedure

1. If the unit does not function as expected on a known functioning configuration, replace the batteries.
If the unit still does not function as expected, call Greenlee for technical assistance at 800-435-0786.
2. Refer to “Typical Measurements” for specific measurement instructions.
3. The meter does not compensate for manufacturing tolerances of various cable manufacturers.
4. Before making a measurement, ensure the following:
 - Cable conductors have been cleaned with abrasive material to remove oxide layer and other contaminants.
 - Kelvin clip jaws are clean.
 - Both the cable and meter are at the same temperature.
 - Cable conductor material must be either aluminum or copper.

5. To measure odd cable sizes:

- **AWG (5, 7, 9, 11 AWG, etc.) (CLM-1000):** When measuring odd numbered cable sizes, set the rotary switch to the next smaller size, and multiply the reading by 1.261.

For example, to measure a 9 AWG length of cable, set the rotary switch to **10 AWG**. Then multiply the reading by 1.261 to get the length.

- **kcmil (CLM-1000):** When measuring odd numbered cable sizes, set the rotary switch to **1000 kcmil**. Divide kcmil size of cable being measured by 1000, and then multiply this number by the meter’s length reading.

For example, 477 kcmil cable is being measured. The multiplier becomes $477/1000 = 0.477$. Take the value shown with the rotary switch in the 1000 kcmil position and multiply it by 0.477 to get the length.

- **mm² (CLM-1000E):** When measuring odd numbered cable sizes, set the rotary switch to **500 mm²**. Divide mm² size of cable being measured by 500, and then multiply this number by the meter’s length reading.

For example, 289 mm² cable is being measured. The multiplier becomes $289/500 = 0.596$. Take the value shown with the rotary switch in the 500 mm² position and multiply it by 0.596 to get the length.

Programming Procedure

1. Calibrate meter according to “Calibration Procedure.”
2. Obtain known length of cable between 30 ft and 320 ft (9 m and 97.5 m) long. Cable must be aluminum or copper.
3. Set rotary switch to desired location. Programmable location appears on the LCD. If the location has already been programmed, “OL” appears on the LCD. If it has not, “no” appears.

*Note: Data in a programmed location can be deleted. With Kelvin clips removed from cable and rotary switch turned to location to delete, press **MEM** button.*

4. Press **CAL** button.
5. Enter the known length of cable in feet or meters. Use \blacktriangledown \blacktriangle arrows.
6. Select “Cu” or “Al”.
7. Connect Kelvin clips to the conductor on each end of the cable.
8. Press **MEM** button. “MEM” and dashes appear on the LCD. After approximately 1 second, “donE” appears on the LCD if programming was successful. If “FAIL” appears, check connections and repeat procedure.

Typical Measurements

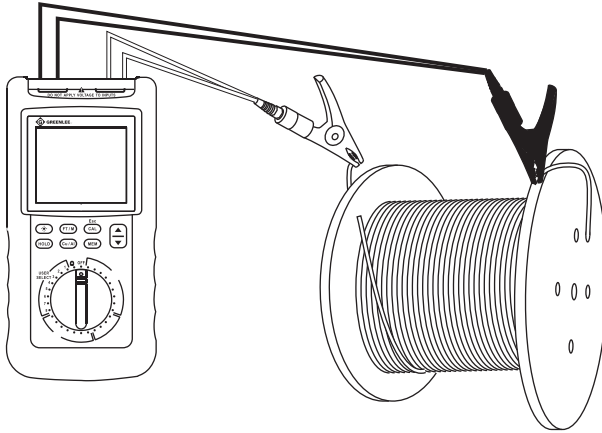

Typical Configuration

Note: Make sure that the clips are as close together as possible in order to improve calibration accuracy.

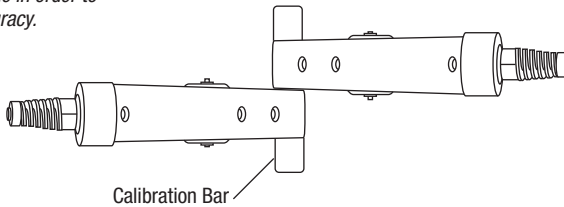

Calibration

Accuracy

Length in feet

Gauges (CLM-1000)	Diameter (mm ²) (CLM-1000E)	Accuracy Range	Length Range	Accuracy
18 AWG–2 AWG	0.75–35	1000.0 ft	15 ft–500.0 ft	± (1.0% + 5.0 ft)
			500.1 ft–999.9 ft	± (1.0% + 9.0 ft)
		10,000 ft	1000 ft–9999 ft	± (1.5% + 38 ft)
			100.00 kft	10.00 kft–50.00 kft
		50.01 kft–100.00 kft		± (1.5% + 0.38 kft)
1/0–4/0	50–95	1000.0 ft	15 ft–500.0 ft	± (1.0% + 5.0 ft)
			500.1 ft–999.9 ft	± (1.0% + 8.0 ft)
		10,000 ft	1000 ft–9999 ft	± (1.5% + 26 ft)
			100.00 kft	10.00 kft–50.00 kft
		50.01 kft–100.00 kft		± (1.5% + 0.26 kft)
250 kcmil–1000 kcmil	120–500	1000.0 ft	15 ft–500.0 ft	± (1.0% + 9.0 ft)
			500.1 ft–999.9 ft	± (1.0% + 12.0 ft)
		10,000 ft	1000 ft–9999 ft	± (1.5% + 33 ft)
			100.00 kft	10.00 kft–50.00 kft
		50.01 kft–100.00 kft		± (1.5% + 0.33 kft)

Length in meters

Gauges (CLM-1000)	Diameter (mm ²) (CLM-1000E)	Accuracy Range	Length Range	Accuracy
18 AWG–2 AWG	0.75–35	1000.0 m	5 m–152.4 m	± (1.0% + 1.6 m)
			152.5 m–304.8 m	± (1.0% + 2.8 m)
			304.9 m–999.9 m	± (1.5% + 11.6 m)
		10,000 km	1.000 km–3.048 km	± (1.5% + 0.012 km)
			3.049 km–9.999 km	± (1.5% + 0.052 km)
		30.00 km	10.00 km–15.24 km	± (1.5% + 0.06 km)
15.25 km–30 km	± (1.5% + 0.12 km)			
1/0–4/0	50–95	1000.0 m	5 m–304.8 m	± (1.0% + 1.6 m)
			304.9 m–999.9 m	± (1.5% + 8.0 m)
		10,000 km	1.000 km–3.048 km	± (1.5% + 0.008 km)
			3.049 km–9.999 km	± (1.5% + 0.058 km)
		30.00 km	10.00 km–15.24 km	± (1.5% + 0.06 km)
			15.25 km–30 km	± (1.5% + 0.08 km)
250 kcmil–1000 kcmil	120–500	1000.0 m	5 m–152.4 m	± (1.0% + 2.8 m)
			152.5 m–304.8 m	± (1.0% + 3.7 m)
			304.9 m–999.9 m	± (1.5% + 10.1 m)
		10,000 km	1.000 km–3.048 km	± (1.5% + 0.010 km)
			3.049 km–9.999 km	± (1.5% + 0.052 km)
		30.00 km	10.00 km–15.24 km	± (1.5% + 0.06 km)
15.25 km–30 km	± (1.5% + 0.11 km)			

Accuracy (cont'd)

Resistance

Range	Accuracy
199.99 m Ω	\pm (1% + 0.05 m Ω)
1.9999 Ω	\pm (1% + 0.5 m Ω)
19.999 Ω	\pm (1% + 5 m Ω)
199.99 Ω	\pm (1% + 50 m Ω)
1999.9 Ω	\pm (1% + 0.5 m Ω)

Temperature: \pm 1.5 °C

Specifications

Display: LCD, 4-1/2 digits 20,000 counts

Operating Conditions: 32 °F to 104 °F (0 °C to 40 °C),
relative humidity < 75%

Storage Conditions: -4 °F to 140 °F (-20 °C to 60 °C),
relative humidity < 85%

Battery: Six 1.5 V batteries (AA, NEDA 15A, IEC LR6)

Dimensions: 198 mm x 98 mm x 56 mm
(7.8" x 3.9" x 2.2")

Current Consumption:

Backlight OFF and no cable is being
measured: Approximately 5 mA

When a cable is being measured:
Approximately 100 mA

APO Timing: Idle for 10 minutes

Low Battery Indicator: Approximately 7.2 V

Statement of Conformity

Greenlee Textron Inc. is certified in accordance with
ISO 9001 (2000) for our Quality Management Systems.

The instrument enclosed has been checked and/or cali-
brated using equipment that is traceable to the National
Institute for Standards and Technology (NIST).

Maintenance

⚠ WARNING

Electric shock hazard:

Before opening the case, remove the test leads from the
circuit and shut off the unit.

Failure to observe this warning could result in severe
injury or death.

Replacing the Batteries

1. Turn the unit OFF. Remove the Kelvin clip leads from the meter.
2. Remove one screw from the battery access door and remove it.
3. Replace the batteries, making sure to observe the polarity.
4. Replace cover and continue with normal operation.

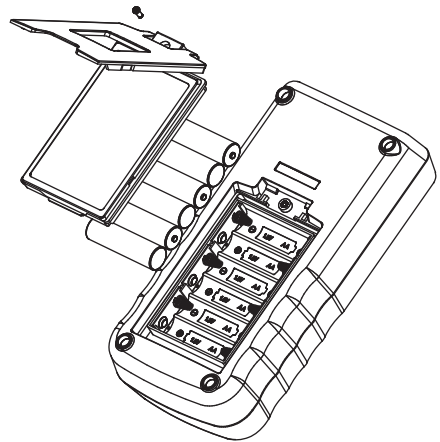

Cleaning and Storage

Periodically wipe the case with a damp cloth and mild
detergent; do not use abrasives or solvents.

If the meter will not be used for periods longer than
60 days, remove the batteries and store them separately.

Lifetime Limited Warranty

Greenlee Textron Inc. warrants to the original purchaser of these goods for use that these products will be free from defects in workmanship and material for their useful life, excepting normal wear and abuse. This warranty is subject to the same terms and conditions contained in Greenlee Textron Inc.'s standard one-year limited warranty.

For items not covered under warranty (such as items dropped, abused, etc.), a repair cost quote is available upon request.

Note: Prior to returning any test instrument, please check replaceable batteries or make sure the battery is at full charge.



99 Washington Street
Melrose, MA 02176
Phone 781-665-1400
Toll Free 1-800-517-8431



Visit us at www.TestEquipmentDepot.com

