



**Test Equipment
Depot**
1-800-517-8431

99 Washington Street
Melrose, MA 02176
Phone 781-665-1400
Toll Free 1-800-517-8431

Visit us at www.TestEquipmentDepot.com

Explorer[®] Balances Instruction Manual



TABLE OF CONTENTS

1. INTRODUCTION	5
1.1 Description	5
1.2 Features	5
1.3 Safety Precautions	5
2. INSTALLATION	6
2.1 Unpacking	6
2.2 Installing Components.....	7
2.2.1 Terminal Setup	7
2.2.2 Installing the Wind Ring, Weighing Platform on Models EX124, EX224, and EX324	7
2.2.4 Installing the Draft Shield Glass and Doors on Draft Shield Models.....	8
2.2.5 Installing the Weighing Pan & Wind Shield – Non-Draft Shield Models	9
2.3 Selecting the Location.....	9
2.4 Leveling the Equipment.....	9
2.5 Connecting Power.....	10
2.5.1 AC Adapter.....	10
2.6 Connecting the Interface.....	10
2.7 Adjusting the View Angle of the Terminal	10
2.8 Remote Terminal Operation.....	11
2.8.1 Separating the Terminal from the Weighing Base	11
2.8.2 Terminal Mounting.....	11
2.9 Initial Calibration.....	11
3. OPERATION	12
3.1 Overview of Display, Home Screen	12
3.2 Principal Functions and Main Menu	12
3.3 Overview of Parts and Features –Draft Shield Models	13
3.4 Overview of Parts and Features – Non-Draft Shield Models	14
3.5 Overview of Parts and Features – Terminal	15
3.6 Functions and Their Icons.....	16
3.6.1 Standby	16
3.6.2 Printing Data.....	16
3.6.3 Applications.....	16
3.6.4 TouchLess Sensor Status	16
3.6.5 AutoCal™.....	16
3.6.6 Menu	16
3.6.7 More.....	16
3.6.8 Level Assist	16
3.6.9 Zero Operation	16
3.6.10 Taring a Container.....	16
3.6.11 Weighing Units	17
3.6.12 Preset Tare.....	17
3.6.13 Calibration Test	17
3.6.14 Calculator	17
3.6.15 Stopwatch.....	17
3.6.16 Logout	17
4. APPLICATIONS.....	18
4.1 Weighing	19
4.1.1 Edit Settings	19
4.1.2 Application Setup	20
4.1.3 Statistics for Weighing.....	21
4.2 Parts Counting	22
4.2.1 Standard Parts Counting (default).....	22
4.2.2 Application Setup	25
4.2.3 Parts Counting – Check	26
4.2.4 Parts Counting – Fill.....	27
4.2.5 Statistics for Parts Counting.....	28
4.3 Percent Weighing.....	30
4.3.1 Edit Settings	30
4.3.2 Application Setup	33
4.4 Check Weighing.....	34

4.4.1	Standard Check Weighing (default)	34
4.4.2	Edit Settings	34
4.4.3	Application Setup	35
4.4.4	Check Weighing – Nominal/Weight Mode	36
4.4.5	Check Weighing – Nominal/Percent Tolerance Mode	37
4.4.6	Display Settings	38
4.4.7	Statistics for Check Weighing	39
4.5	Dynamic/Animal Weighing	40
4.5.1	Edit Settings	41
4.5.2	Application Setup	41
4.5.3	Dynamic Weighing – Semi-Auto	42
4.5.4	Dynamic Weighing – Automatic	43
4.5.5	Statistics for Dynamic Weighing	44
4.6	Filling	45
4.6.1	Edit Settings	45
4.6.2	Application Setup	46
4.6.3	Statistics for Filling	47
4.7	Totalization	49
4.7.1	Totalization – Manual (Default)	49
4.7.2	Application Setup	50
4.7.3	Totalization – Automatic	51
4.8	Formulation	52
4.8.1	Free Formulation (default)	52
4.8.2	Application Setup	53
4.8.3	Recipe Formulation	54
4.9	Differential Weighing	57
4.9.1	Item Settings	57
4.9.2	Application Setup	59
4.9.3	Differential Weighing with Auto-Process On	60
4.10	Density Determination	61
4.10.1	Measuring the Density of a Solid Using Water (default)	61
4.10.2	Application Setup	63
4.10.3	Measuring the Density of a Buoyant Material Using Water	64
4.10.4	Measuring the Density of a Solid Using an Auxiliary Liquid	64
4.10.5	Measuring the Density of a liquid using a Calibrated Sinkers (not supplied)	65
4.10.6	Measuring the Density of Porous Material Using Oil	67
4.11	Peak Hold	69
4.11.1	Peak Hold – Semi-Automatic (default)	69
4.11.2	Application Setup	70
4.11.3	Peak Hold – Manual	71
4.11.4	Peak Hold – Automatic	72
4.12	Ingredient Costing	73
4.12.1	Item Settings	73
4.12.2	Application Setup	76
4.13	Pipette Adjustment	77
4.13.1	Pipette Adjustment – Manual (default)	77
4.13.2	Begin Pipette Adjustment Process	79
4.13.3	Application Setup	80
4.14	Statistical Quality Control (SQC)	81
4.14.1	Edit Settings	81
4.14.2	Begin the SQC Process	82
4.14.3	Application Setup	84
4.15	Statistics	85
4.16	Library	85
4.16.1	Creating a Library Record	85
4.16.2	Retrieving a Library Record	86
4.16.3	Deleting a Stored Library Record	86
4.17	Additional Features	87
4.17.1	Weigh Below	87
5.	MENU SETTINGS	88
5.1	Menu Navigation	88
5.1.1	Changing Settings	88
5.2	Main Menu	89

5.3	Calibration	89
5.3.1	Calibration sub-menu	89
5.3.2	Internal Calibration (AutoCal™)	89
5.3.3	Automatic Calibration	89
5.3.4	AutoCal™ Adjustment	90
5.3.5	Span Calibration	90
5.3.6	User Calibration	91
5.3.7	Calibration Test	91
5.4	User Settings	92
5.4.1	User Settings Sub-menu	92
5.4.2	Language	92
5.4.3	Volume	92
5.4.4	Display Settings	92
5.4.5	User Manager	92
5.4.6	Functions Configuration	93
5.4.7	TouchLess Sensor Setup	93
5.4.8	Draft Shield light	93
5.5	Balance Setup	94
5.5.1	Balance Set-up sub-menu	94
5.5.2	Stable Range	94
5.5.3	Filter level	94
5.5.4	Auto Zero Tracking	94
5.5.5	Auto Tare	95
5.5.6	Gross Indicator	95
5.5.7	Legal For Trade	95
5.5.8	Graduations	95
5.5.9	Date & Time	95
5.6	Applications	96
5.6.1	Turning an Application ON/OFF	96
5.7	Weighing Units	96
5.7.1	Units Sub-menu	96
5.7.2	Turning a Unit ON/OFF	97
5.7.3	Custom Units	97
5.8	GLP and GMP Data	98
5.8.1	GLP Data Sub-menu	98
5.8.2	Header	98
5.8.3	Balance Name	98
5.8.4	User Name	98
5.8.5	Project Name	98
5.9	Communication	99
5.9.1	Communication Sub-menu	99
5.9.2	Baud Rate	99
5.9.3	Transmission	99
5.9.4	Handshake	100
5.9.5	Alternate Command	100
5.9.6	Print Output	100
5.9.7	Auto Print	101
5.9.8	Print Calibration Data	101
5.9.9	Print Content	101
5.9.10	Print Layout	103
5.9.11	Data Transfer Function	103
	Double click "Accessibility Options" in control panel	104
5.10	Library	105
5.11	I/O Settings	105
5.12	Diagnostics	105
5.12.1	Level Bubble Light	105
5.12.2	Draft Shield Light (Analytical models)	105
5.12.3	Sensors	105
5.12.4	Service Menu	105
5.13	Factory Reset	106
5.13.1	Factory Reset Sub-menu	106
5.13.2	Reset Calibration	106
5.13.3	Reset User Settings	106

5.13.4	Reset Balance Setup.....	106
5.13.5	Reset Application Modes	106
5.13.6	Reset Weighing Units.....	106
5.13.7	Reset GLP and GMP Data.....	106
5.13.8	Reset Communication.....	106
5.13.9	Reset I/O Settings	106
5.13.10	Reset All (Global Reset).....	106
5.14	Lockout.....	107
5.14.1	Lockout Sub-menu	107
5.14.2	Lock Calibration.....	107
5.14.3	Lock User Settings	107
5.14.4	Lock Balance Setup	107
5.14.5	Lock Application Modes	107
5.14.6	Lock Weighing Units.....	107
5.14.7	Lock GLP and GMP Data.....	107
5.14.8	Lock Communication.....	108
5.14.9	Lock Library.....	108
5.14.10	Lock I/O Settings	108
5.14.11	Factory Reset	108
5.15	Securing the Menu and Key Lock menu settings.....	108
5.16	Information	109
5.16.1	Using Information	109
6.	LEGAL FOR TRADE.....	110
6.1	Settings	110
6.2	Verification.....	110
6.3	Sealing	110
7.	PRINTING	111
7.1	Connecting, Configuring and Testing the Printer/Computer Interface.....	111
7.2	Printout Examples	112
7.3	Output Format	120
8.	MAINTENANCE	121
8.1	Calibration	121
8.2	Cleaning	121
8.3	Troubleshooting	121
8.4	Service Information	121
9.	TECHNICAL DATA	122
9.1	Specifications	122
9.2	Drawings and Dimensions	129
9.3	Parts and Accessories	130
9.4	Icons List	131
9.5	Communication	137
9.5.1	Interface Commands.....	137
9.5.2	RS232 (DB9) Pin Connections.....	140
9.6	The USB Interface.....	140
10.	SOFTWARE UPDATES	144
11.	COMPLIANCE.....	145

1. INTRODUCTION

1.1 Description

The Explorer balance is a precision weighing instrument that will provide you with years of service if properly cared for. The Ohaus Explorer balances are available in capacities from 120 grams to 10,200 grams.

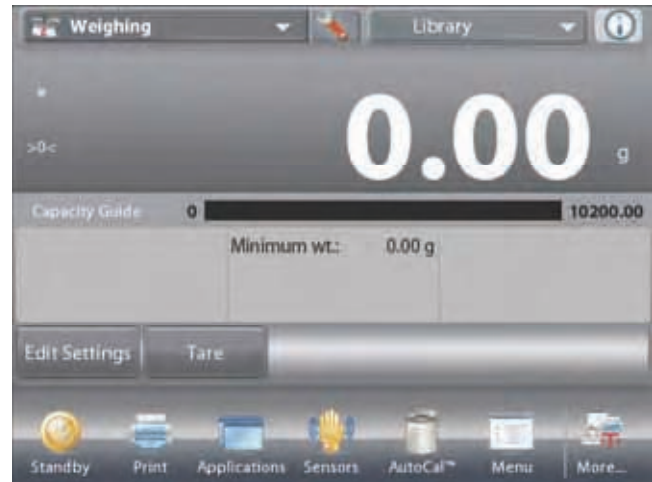
1.2 Features

Modular Design: Ohaus Explorer balances are composed of two interconnected modules: a Terminal and a Base. Depending on the user's needs, the unit can be operated with the Terminal either attached to, or remote from, the Base, with a single interconnect cord 1 meter long.

Touch Controls: Quick, graphical access to all control functions, over a dozen applications and many features.

Touchless Sensors: can be assigned functions when activated: Zero, Print, Tare, etc.

Statistics: available in Weighing, Counting, Percent Weighing, Check Weighing, Dynamic Weighing, Filling, Density Determination, Pipette Adjustment and Statistical Quality Control applications.



1.3 Safety Precautions










Caution: Read all safety warnings before installing, making connections, or servicing this equipment. Failure to comply with these warnings could result in personal injury and/or property damage. Retain all instructions for future reference.

- Verify that the input voltage range printed on the data label and the plug type matches the local AC power to be used.
- Make sure that the power cord does not pose a potential obstacle or tripping hazard.
- Use the balance only in dry locations.
- Do not drop loads on the pan.
- Use only approved accessories and peripherals.
- Operate the equipment only under ambient conditions specified in these instructions.
- Disconnect the equipment from the power supply when cleaning.
- Do not operate the equipment in hazardous or unstable environments.
- Service should only be performed by authorized personnel.

2. INSTALLATION

2.1 Unpacking

Carefully remove your Explorer balance and each of its components from the package. The included components vary depending on the balance model (see table below). Save the packaging to ensure safe storage and transport.

Included Component		Photo	EX124 EX224 EX324	EX223 EX423 EX623 EX1103	EX2202 EX4202 EX6201 EX6202 EX10201 EX10202
Terminal			X	X	X
Weighing Base			X	X	X
Weighing Platform	90 mm Diameter		X		
	130 mm Diameter			X	
	180 x 210 mm				X
Sub-Platform	130mm Diameter			X	
Support Caps (4 Pcs)					X
Wind Ring			X		
Wind Shield					X
Draft Shield Assembly			X	X	
Power Adapter			X	X	X
Power Cord	(Country specific)		X	X	X
Use Cover	Terminal		X	X	X
Compact Disk:	USB Software		X	X	X
Instruction Manual			X	X	X
Quick Start Guide			X	X	X
Warranty Card			X	X	X

2.2 Installing Components

Refer to the illustrations and instructions below to identify and assemble your Explorer balance with its components. All components must be assembled before using the balance.

2.2.1 Terminal Setup

When the Explorer is delivered, the Terminal is already attached (docked) to the Base. No additional setup is necessary. However, for Draft Shield models, the Terminal needs to be detached temporarily in order to assemble parts of the Draft Shield. Refer to the illustrations and instructions below to identify and assemble your Explorer Balance.

Note: The Terminal is identical for all Explorer Balance models.

2.2.2 Installing the Wind Ring, Weighing Platform on Models EX124, EX224, and EX324

Note: Assembly instructions also apply to models with the suffix M or N.

1. Place the Wind Ring in position.
2. Insert the Platform Assembly onto the Mounting Cone located in the center of the Balance.



2.2.3 Installing the Sub-Platform and Weighing Pan on Models EX223, EX423, EX623 and EX1103

1. Place the Sub-platform in position.
2. Position the Platform on the Sub-platform.



2.2.4 Installing the Draft Shield Glass and Doors on Draft Shield Models





1. Carefully remove each of the four glass Draft Shield sections from the packaging.

NOTE: Before installing side doors, be sure to set the lock tabs in the proper position, as shown here.



2. Follow the steps below to install side, front and top doors of the Draft Shield.





Side Door Installation

- 1. Unlock 
- 2. Align 
- 3. Clear 
- 4. Lock 



Position glass door to slide. Open lock tab (top); insert in top groove and slide inside bottom groove. Close lock tab.



Front Panel Installation

- 1. Release terminal 
- 2. Align 
- 3. Push to rear 
- 4. Reconnect terminal 



Press button to separate Terminal from Base. Seat panel's hooked ends in base. Swing panel to vertical position.

Top Door Installation

- 1. Align 
- 2. Press Down 



Insert Top Door's hooked ends in grooved pegs. Press gently to seat. Check for smooth movement. Close door.

2.2.5 Installing the Weighing Pan & Wind Shield – Non-Draft Shield Models

Note: Assembly instructions also apply to models with the suffix M or N.

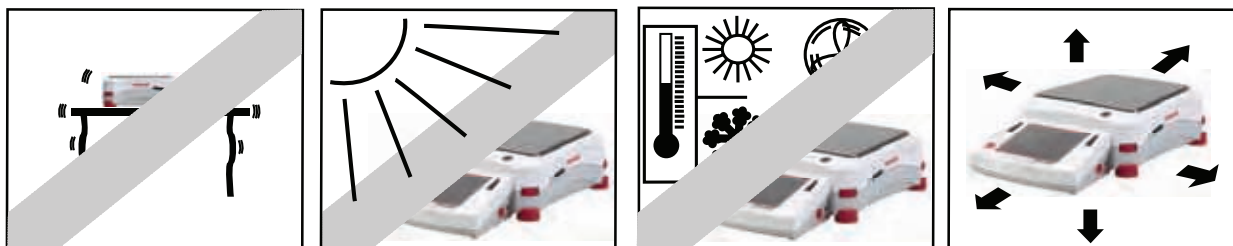
1. Place the four Support Caps onto the Balance as shown.
2. Place the Weighing Pan on the Support Caps
3. Place the Wind Shield onto the Balance as shown.



Note: The balance can be operated without the Wind Shield. However, depending on ambient conditions the displayed results may be slightly less stable.

2.3 Selecting the Location

Avoid excessive vibrations, heat sources, air current, or rapid temperature changes. Allow sufficient space.



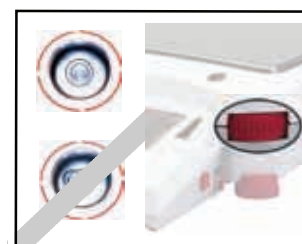
Note: Interface cables connect to the terminal. The terminal can be detached and mounted on a wall or positioned on a table separate from the balance.

2.4 Leveling the Equipment

The Explorer has an illuminated level indicator as a reminder that the balance should be leveled for accurate weighing. There is a level bubble in a small round window on the front of the Base. To level the balance, adjust the **Leveling Thumbwheels** at each corner until the bubble is centered in the circle.

Be sure the equipment is level each time its location is changed.

Note: The feet cannot rotate. The Thumbwheels must be used for leveling.



See the Level Assist screen in the Information Menu.

To see the Level Assist menu, touch **More** on the bottom-right corner of the main screen. Then touch **Level Assist**.

The Level Assist screen shows which direction to turn the thumbwheels to center the level bubble.



2.5 Connecting Power

2.5.1 AC Adapter

Connect the power cord of the AC Adapter (supplied) to the power receptacle on the rear of the Base. Then connect the AC adapter plug to a suitable electrical outlet.



Caution: For use with CSA certified (or equivalent approved) power source, which must have a limited current output.



Note: Allow equipment to warm up for 60 minutes for optimal weighing performance.



Standby: When unit is plugged in, it starts in **Standby** mode. Press the Standby icon to start.

2.6 Connecting the Interface

Use the built-in RS-232 (10101) Port to connect either to a computer or a printer with a standard (straight-through) serial cable. Or connect using the scale's USB port.

Note: For configuration and interface commands, see the Communication Menu Settings section. For Connecting, Configuring and Testing the Printer/Computer Interface, and for sample Print Output Formats, see the Printing section.



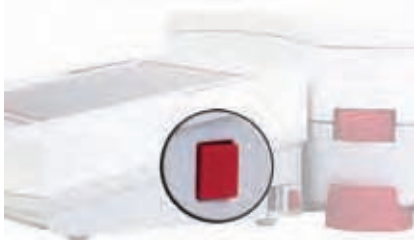
Interface connections on back of Terminal.



Thread printer cable along cable coils on bottom of balance. Or pass cable through groove near release button.

2.7 Adjusting the View Angle of the Terminal

To adjust the Terminal display's viewing angle, press in the Terminal Adjust buttons on both sides of the Terminal.



2.8 Remote Terminal Operation

The Terminal communicates with the weighing base via the Terminal cable. This cable must be plugged into the Terminal for the Explorer to display properly. If desired, the Explorer balance may be operated either with the Terminal attached (as-shipped), or remotely (up to 1 meter away).

2.8.1 Separating the Terminal from the Weighing Base

1. To detach, press both the Release buttons inward (both at the same time) and gently pull the Terminal towards you (outward) until the Terminal is detached. These Release buttons disengage the two hooks holding the Terminal to the Base. A cable is attached to the Terminal. Take care to not damage or disconnect this cable.
2. To reattach the Terminal, press in the two Release buttons and slide the Terminal into the Base until the Terminal hooks click and engage to hold the Terminal in place.



Note: If a longer operation distance is required, a Terminal Extension cable is available as an accessory.

2.8.2 Terminal Mounting

If desired, the Terminal may be mounted to a wall or table using fasteners (not supplied) that are appropriate for the type of mounting surface. The Terminal bracket will accommodate 4mm (#8) screws. Locate the mounting holes as shown in Figure 2-1.

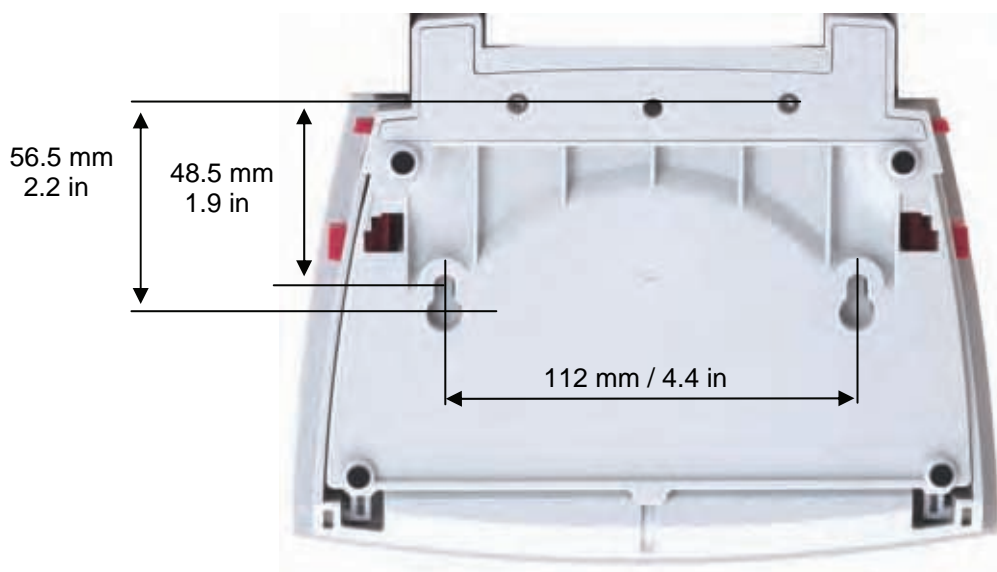


Figure 2-1. Terminal Mounting Dimensions.

2.9 Initial Calibration

When the Balance is first installed, and when it is moved to another location, it must be calibrated to ensure accurate weighing results. The Explorer Balances have built in AutoCal which can calibrate the balance automatically and does not require calibration masses. If preferred, the balance can be manually calibrated with external masses. Have the appropriate calibration masses available before beginning calibration. Refer to the Calibration Section for masses and calibration procedure.

3. OPERATION

3.1 Overview of Display, Home Screen

This equipment utilizes a touch-sensitive display. *Touch* areas and Buttons to control the equipment's functions.

CONTROLS

Instructional Messages
Stability (*), Net (NET), Gross (G) and/or center of zero (>0<) indicators

Result Fields:
Information varies by application

Touch icons to perform specific functions or access other functions



Touch to access application setup menu
Touch to change applications
Touch to access available libraries

Touch for information menu

Touch unit indicator to change weighing unit

Capacity or Status Guides:
Vary by application

Application Buttons:
Functions vary by application

3.2 Principal Functions and Main Menu

Weighing: Press **Tare** to set the display to zero. Place an item on the pan. Display indicates gross weight.

Taring: With no load on the pan, press **Tare** to set the display to zero. Place an empty container on the pan and press **Tare**. Add material to the container and its net weight is displayed. Remove container and container's weight appears as a negative number. Press **Tare** to clear.

MENU & SCREEN NAVIGATION

Touch **Menu** to open the menu list.

Touch and drag the **Scroll bar** to view additional items.



Calibration:
Touch to view calibration options.



User Settings:
Touch to view user preferences.



Balance Setup:
Touch to view balance settings.



Application Modes:
Touch to view application modes.



Weighing Units:
Touch to view weighing units.



GLP and GMP Data:
Insert user data for traceability.



Communication:
Touch to view COM Device Settings and Print Settings.



Library:
Touch to delete all Library records.



I/O Settings:
Touch to view remote I/O Settings.



Diagnostics:
Touch to view Diagnostics items.



Factory Reset:
Touch to do a Factory reset.



Lockout:
Touch to access the Lockout menu list.



Information:
Touch to view list of topics.

3.3 Overview of Parts and Features –Draft Shield Models



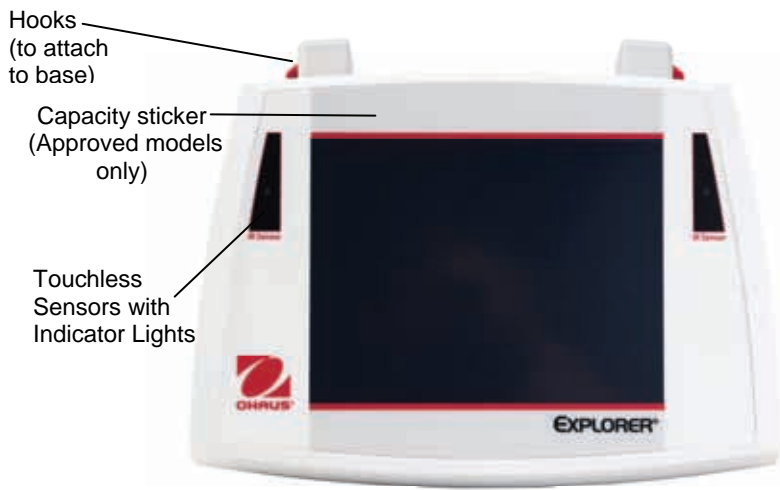
Figure 3-1. Explorer Balance (models EX124, EX224, EX324, EX223, EX423, EX623, EX1103)

3.4 Overview of Parts and Features – Non-Draft Shield Models

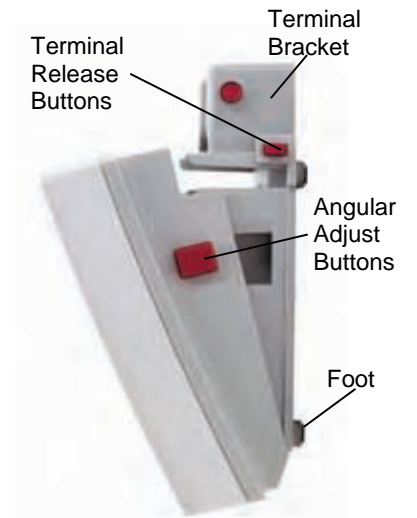


Figure 3-2. Explorer Base (models EX2202, EX4202, EX6202, EX10202, EX6201, EX10201)

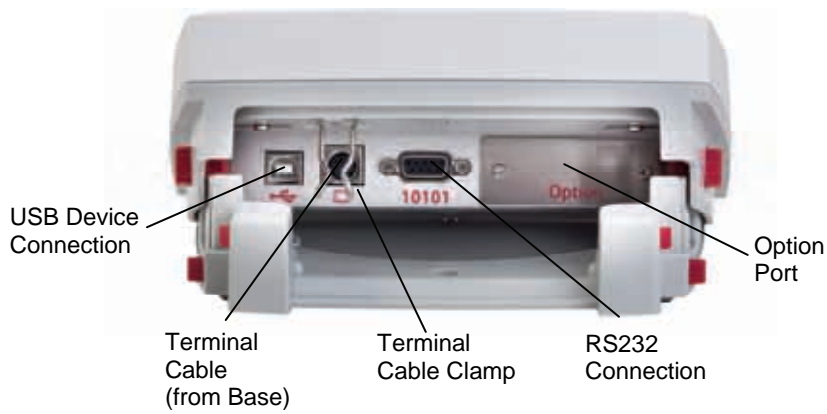
3.5 Overview of Parts and Features – Terminal



Top View



Side View



Back View

Figure 3-3. Explorer Terminal

3.6 Functions and Their Icons

Seven Icons are initially available to operate the Balance and access the Menu. These Icons can be customized based on user preference. For setup information, see **User Settings**.



3.6.1 Standby

Touch Standby to shut down the display.

Note: After initial start-up (Section 2), in Standby your balance needs no warm-up time and is immediately available for weighing by touching the Start-up icon.



3.6.2 Printing Data

Touch **Print** to send the displayed value to a printer or computer via the active COM port.

Note: Ensure proper setup of connections, printing and interface parameters.

Note: Data may also be printed using the Touchless Sensors by configuring these for Printing. Data may also be printed using the P command from a computer connected to the COM port.



3.6.3 Applications

The balance can be configured to operate in various Application modes. Touch Applications to choose – or the top button in the Application area.



3.6.4 TouchLess Sensor Status

Explorer balances have four **TouchLess** sensors that can be assigned a unique function when activated (e.g., zero, print, tare, etc).

To assign a task for each TouchLess sensor, press **Sensors**.

Note: To activate a sensor, move an object over it (from a distance of 1-2 inches or 3 cm). The sensor shows a green light and beeps when activated. If the sensor cannot be activated (sensor is disabled during certain instances, like when the Menu is displayed) the sensor shows a red light.



3.6.5 AutoCal™

When AutoCal is ON, the balance performs a self calibration. AutoCal will automatically calibrate the Balance (using the internal mass) each time a change in temperature significant enough to affect accuracy, or after every 11 hours.

Touch **AutoCal™** to initiate. (Default status is ON.)



3.6.6 Menu

Touch **Menu** to enter the balance's menu list.



3.6.7 More...

Touch More to access Level Assist, Zero, Tare, Units, Pretare, Cal Test, Calculator, and Stopwatch.



3.6.8 Level Assist

For assistance with Leveling the Balance; the Level Assist screen shows which direction to turn the thumbwheels to center the level bubble.



3.6.9 Zero Operation

Remove the load from the pan and touch **Zero** to set the display to zero. When weighing pan is empty, the **>0<** indicator turns on when the measurement is within $\pm \frac{1}{4}$ division (d) of the zero setting.

Note: The balance also features Auto Zero Tracking (AZT) that automatically maintains a Center of Zero within the tolerances set in the AZT menu (see Balance Settings).



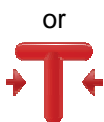
3.6.10 Taring a Container

Taring sets the weight of a container as zero, so only the weight of objects held in the container (net weight) is displayed.

Manual Tare – Place the empty container on the pan and touch **Tare** when stable.

Add material to the container. The net weight of the material is displayed.

To clear the Tare value, remove the container from the pan and touch **Tare**.





3.6.11 Weighing Units

The balance can be configured to measure in a variety of weighing units, including three (3) custom units. Touch **Units** to choose from the displayed list. *(Scroll down to see all options.)*

Note: The active weighing Unit can also be accessed by touching the unit area of the Main Display line; If a unit is not displayed in the list, it must first be turned on via the User Menu.



3.6.12 Preset Tare

To enter a Preset Tare, press the Icon and then enter a value; enter 0 to clear the Preset Tare. The display will show the PT symbol and the tare value as a negative number.



3.6.13 Calibration Test

is used to compare a known calibration weight against the last stored span calibration data.



3.6.14 Calculator

To use the built-in calculator application, touch **Calculator**. A four function calculator with addition, subtraction, multiplication and division mathematical operations is available

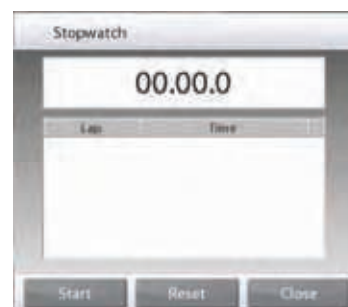
- Perform a numeric operation using the keypad.
- Press = to view the result.
- To Clear the display: Press **CE** to clear the entry, **C** to clear all
- Touch X to close and return to the current Application.



3.6.15 Stopwatch

To use the built-in stopwatch application, touch **Stopwatch**. A countdown timer with interval (lap) timer is available.

- Press Start to begin using the Stopwatch timer.
- Press Reset to reset the timer to Zero.
- Touch Close to close and return to the current Application.

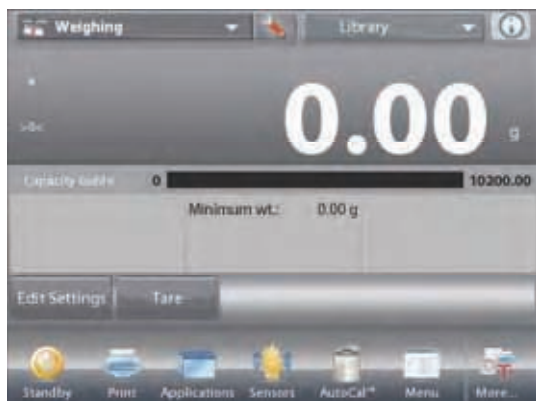


3.6.16 Logout

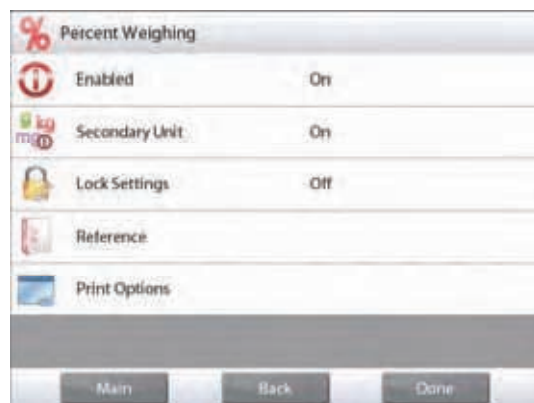
Used for User logout and return to User Login screen. This feature is only active if a user profile has been created and a User has logged in.

4. APPLICATIONS
















The balance can be configured to operate in various Application modes. Touch **Applications** to choose – or the top button in the Application area:



Note: If an application mode does not appear in the list of available Applications it must be **enabled** in the User Menu: touch **Menu**, then select **Application Modes**. The full list of modes appears. Touch the one you want to enable. Then touch **Enabled** in the setup menu for that application mode – Percent Weighing in the example below. Each enabled mode appears in the **Applications** menu.



The Explorer Balance incorporates the following Applications.

 Weighing	 Parts Counting	 Percent Weighing	 Check Weighing	 Dynamic (Animal) Weighing	 Filling
 Totalization	 Formulation	 Differential Weighing	 Density Determination	 Peak Hold (High Point)	 Ingredient Costing
 Pipette Adjustment	 Statistical Quality Control (SQC)	 Library (complements most Applications)			

4.1 Weighing

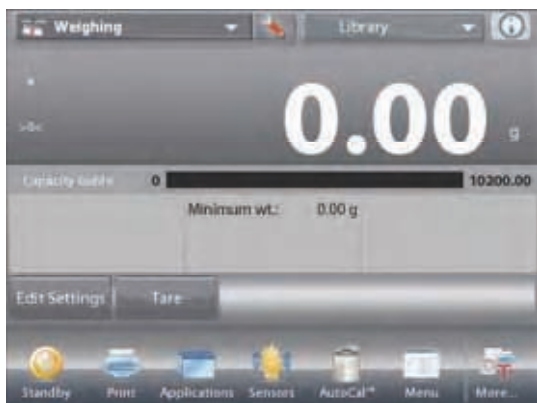
Note: Before using any application, be sure the balance has been leveled and calibrated.

Use this application to determine the weight of items in the selected unit of measure.

Note: The Explorer is shipped with all units enabled.

Weighing

1. In the upper left portion of the home screen, select Weighing (this application is the default).
2. Press **Tare** or **Zero** if necessary to begin.
3. Place objects on the pan to display the weight. When stable, the * appears.
4. The resulting value is displayed in the main Weighing Line in the active unit of measure.



The **WEIGHING** Home screen

Main Display Line

Second Display Line (not shown)

Reference Fields

Application Buttons

Functions



Application Icon

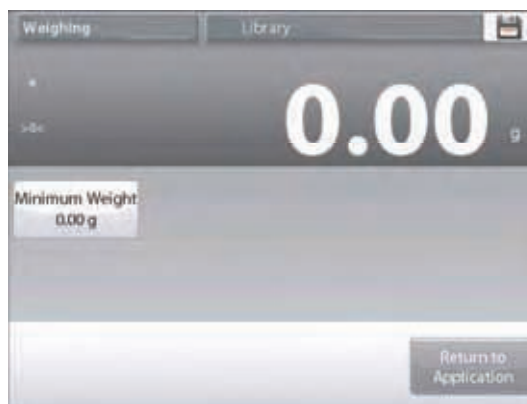
4.1.1 Edit Settings

To view or adjust the current settings

Touch the **Edit Settings** button. The Settings screen appears.

Minimum Weight: establish a minimum weight value to be used to verify a reading. If an actual weight is below the established Minimum Weight value, it is flagged by a color change: **yellow**.

To adjust the Minimum Weight value, touch the **Minimum Weight** button.



A numeric input window appears.

Use the keys to enter the desired Minimum Weight, then press ✓.

The display reverts to the previous screen with the new Minimum Weight value highlighted: **orange**.

To return to the Weighing home screen, touch **Return to Application** at bottom-right of that screen.



4.1.2 Application Setup

The Application can be customized for various user preferences.

Touch the **Setup Icon** (wrench) to enter **Application Setup**.



The **Application Setup Menu** is now displayed.

Select the list item to view or change the setting as desired.

To return to the Application home screen, touch **Done**.



The **Weighing Application Setups** are below (defaults in **Bold**)

Item	Available Settings	Comments
Enabled	On , Off	Turns Application on/off
Secondary Unit	On, Off	To show the Second Display line
Minimum Weight	On , Off	To enable Min Weight
Statistics	Off , Manual, Auto	
Lock Settings	On, Off	Press to lock the current setting(s) so they cannot be changed.
Reference fields		
Min Weight	On , Off	Min Weight is displayed
Gross	On, Off	Gross weight is displayed
Net	On, Off	Net weight is displayed
Tare	On, Off	Tare weight is displayed
Print Options		
Min Weight	On , Off	

4.1.3 Statistics for Weighing

The Statistics function allows you to compare a number of samples and examine the relative deviation of each sample from the mean, along with other statistical data. A minimum of three samples is required.

Statistics can be determined **manually** (requires key press after each step) or **automatically** (weights are automatically recorded when stable). To use the Statistics function, enable it in the Application Setup menu. *This feature is available in **Weighing, Counting, Check Weighing, Dynamic/Animal Weighing** and **Filling** applications.*

Application Setup: First, enable Statistics

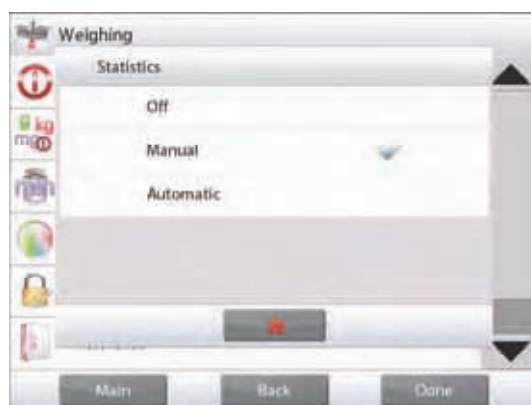
Touch the **Setup Icon** (wrench) to enter Setup menu to enable **Statistics**.



The **Statistics options** screen appears.



Enable the desired mode (Manual, Auto)
Press **Close** to return to the Setup menu.
To return to the Application home screen, press **Done**.



Accumulating displayed values & viewing data – Manual
Once **Statistics-Manual** is enabled, two buttons appear on the Application screen; **Statistics** and **Accumulate**.

Application – Auto

Statistics Auto mode is similar to Manual mode, except the first stable weight is automatically captured, so the **Accumulate** button is not shown.

To add the sample to the data set, place the item on the pan and press **Accumulate**.

When stable, the **Statistics** button lights briefly to show the item is added to the set, and the data set quantity increments by one.

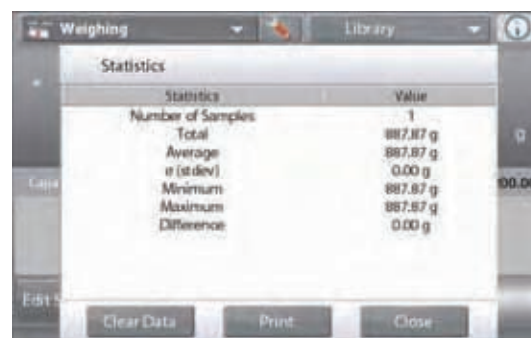
Continue to add items and press **Accumulate** to build the data set.

Press the **Statistics** button to view the results, as shown here.

Press **Print** to send results to the enabled **COM** port.

Press **Close** to return to the Application home screen without clearing the current statistics set.

Press **Clear Data** to clear results and return to the home screen.



4.2 Parts Counting

Use this application to count samples of uniform weight. Three different modes can be selected: **Standard Counting**, **Check Counting**, or **Fill Counting**.

4.2.1 Standard Parts Counting (default)

In the upper left portion of the home screen, select **Counting**. The default (or last) Average Piece Weight (APW) is displayed.

Place objects on the pan to display the number of pieces.



The **PARTS COUNTING-Standard** Home screen

Main Display Line
Second Display Line

Reference Fields

Application Buttons

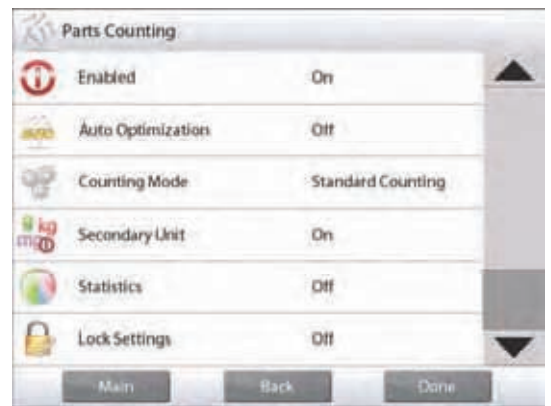
Functions



Application Icon

The **Auto Optimization** feature improves counting accuracy: it automatically re-calculates the piece weight as parts are added. By default APW Optimization is **Off**.

When a new APW is established, APW Optimization occurs when the number of pieces added to the pan is between one and three times the number already on the pan. The screen momentarily indicates **Auto Optimization** in the information line.



4.2.1.1 Edit Settings: To view or adjust the current settings, touch the **Edit Settings** button:

The Settings screen is now displayed.

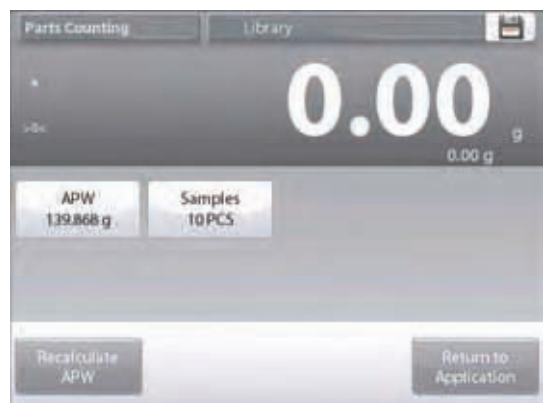
Settings available: **APW, Sample Size,**
Functions available: **Recalculate APW,**
Return to Application

Establish an Average Piece Weight (APW)

Each time a new type of part is counted, the nominal weight of one piece (Average Piece Weight or APW) must be established using a small quantity of pieces. This APW is stored until replaced by another APW.

There are two methods to establish the APW value:

1. The actual APW is known; or
2. The APW must be derived by weight. For this case the current sample size will be used



To choose a different value, establish it beforehand, using the **Sample Size** button. (See below.)

Set a known Average Piece Weight (APW)

To adjust the APW value directly, touch the **APW** button. A numeric input window appears. Key in the desired APW Weight, then press ✓. The display returns to the previous screen with the new APW value highlighted.

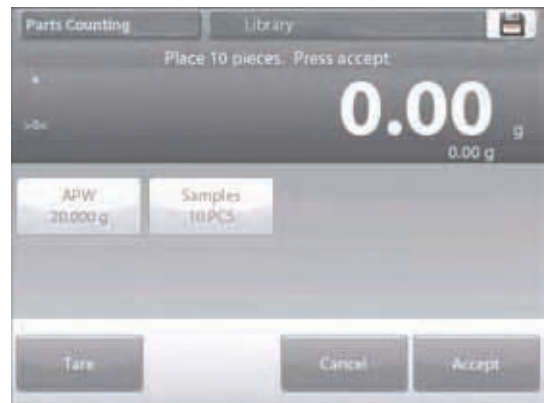


To return to the Counting home screen, touch **Return to Application**.

Set a new Average Piece Weight (APW) – Derived

To establish a new APW, touch the **Recalculate APW** button. The APW Screen is displayed.

NOTE: The sample size that is displayed will be used. To use a different sample size, change that first. (See below.)



Follow the screen instructions to establish a new APW. Actions available: **Tare**, **Cancel**, or **Accept**. Press **Accept** to capture the value and return to the Settings screen. The Settings screen returns with the new APW value highlighted.



To return to the Counting home screen, touch **Return to Application**.

The home screen shows 10 pieces at the new APW



4.2.1.2 Sample Size

The sample size can be 1 to 100 pieces. The default sample size is 10. Once a sample size is changed, the balance will immediately open the **Recalculate APW** screen, expecting to establish a new APW.

The current sample size is shown on the **Settings** screen.

To adjust the sample size, touch the **Samples** button.



A numeric input window appears.

Key in the desired Sample Size, then press ✓.

The next screen appears, with the message to place the number of pieces entered in the numeric input window.



Place the indicated number of pieces on the platform.

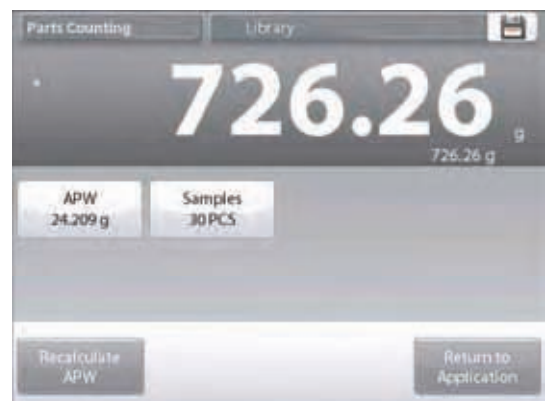
Then touch either **Tare**, **Cancel**, or **Accept**.

Press **Accept** to capture the value and return to the Settings screen.



The Settings screen appears with the new APW value highlighted.

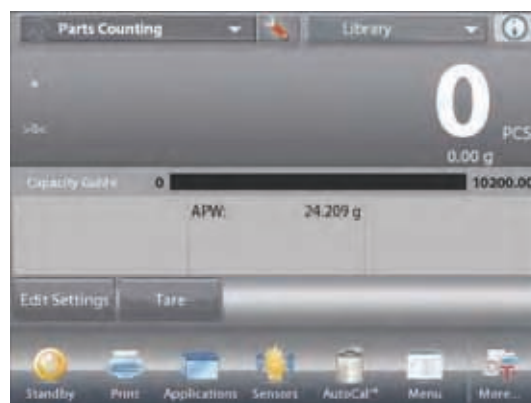
To begin counting pieces, touch **Return to Application**.



4.2.2 Application Setup

The Application can be customized for various user preferences.

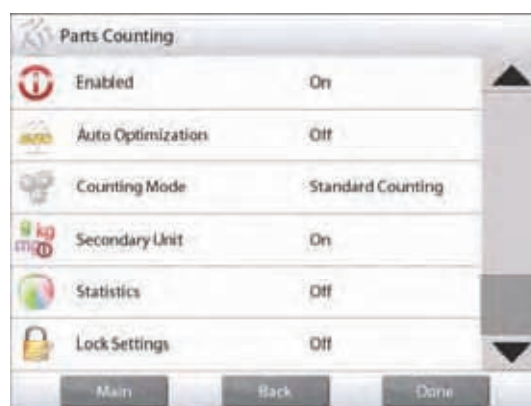
Touch the **Setup Icon** (wrench) to enter **Application Setup**.



The **Application Setup Menu** appears.

Select the list item to view or change the setting as desired.

To return to the Application home screen, touch **Done**.



The Counting Application Setups are below (defaults in **Bold**).

Item	Available Settings	Comments
Enabled	On , Off	Turns Application on/off
Auto Optimization	On, Off	
Counting Mode	Standard Counting , Check Counting, Fill Counting	Select the Mode
Secondary Unit	On , Off	To show the Second Display line
Statistics	Off , Manual, Auto	
Lock Settings	On, Off	Press to lock the current setting(s) so they cannot be changed.
Reference fields		
APW	On , Off	The APW is displayed
Gross	On, Off	Gross weight is displayed
Net	On, Off	Net weight is displayed
Tare	On, Off	Tare weight is displayed
Target	On , Off	Used for Check-Fill only
Difference	On , Off	Used for Check-Fill only
Over Limit	On , Off	Used for Check-Counting only
Under Limit	On , Off	Used for Check-Counting only
Print Options		
APW	On , Off	
Sample Size	On , Off	
Target	On , Off	Used for Check-Fill only
Difference	On , Off	Used for Check-Fill only
Over Limit	On , Off	Used for Check-Counting only
Under Limit	On , Off	Used for Check-Counting only

4.2.3 Parts Counting – Check

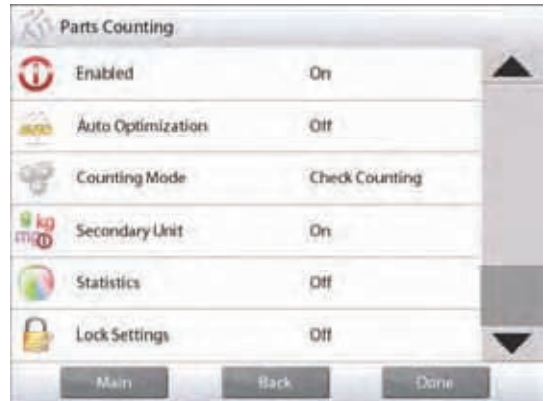
This feature permits establishing a set quantity of pieces as criteria for similar items that can be quickly checked against a sample.



Press the Setup (wrench) button to enter the Counting Setup menu.



Change Counting Mode to **Check Counting**.



The PARTS COUNTING – Check Home screen

Main Display Line
Second Display Line

Reference Fields

Application Buttons

Functions

The default (or last) Average Piece Weight (APW) is displayed. Place objects on the pan to display the **Check Status** (number of pieces).

4.2.2.1 Edit Settings: To use the Parts Counting-Check mode, the **Over Limit** and **Under Limit** values must be set.

The **Average Piece Weight** and standard sample size can also be set. Follow these steps:

Touch the **Edit Settings** button. The Settings screen appears.

The buttons for **APW**, **Samples**, **Over Limit** and **Under Limit** show default (or previously set) values. To change any value, touch the button. A keyboard screen appears.

(See keyboard screens, next page.)

To set a new average piece weight, press the **Recalculate APW** button.

A new screen appears with the message:

Place 30 pieces. Press Accept
(Default is 10 pieces, but message matches number of pieces in **Samples** button.)

After following these instructions, press **Return to Application** on the main **Edit Settings** screen.





4.2.4 Parts Counting – Fill

This feature permits establishing a set quantity of pieces as a reference, so when pieces are added, their percentage of the reference amount appears. A Progress bar indicates the percentage.

In the upper left portion of the home screen, select **Parts Counting**.

(The option will appear if it has been enabled in the Application Modes menu.)



Press the Setup (wrench) button to enter the Counting Setup menu.



Change Counting Mode to **Fill Counting**.



The PARTS COUNTING – Fill Home screen

- Main Display Line
- Second Display Line
- Reference Fields
- Application Buttons
- Functions



The default (or last) Average Piece Weight (APW) is displayed. Place objects on the pan to display the Fill Status.

4.2.3.1 Edit Settings: To use the Parts Counting-Fill mode, the Target (in pieces) and Difference values (in percent) must be set up in the Settings Menu.

Touch the **Edit Settings** button. The Settings screen appears.

The buttons for **APW**, **Samples** and **Target** show default (or previously set) values. To change values, touch the button. A keyboard screen appears. Key in the new value, and press **Done**. To set a new average piece weight, press **Recalculate APW**.

A new screen appears saying: **Place 10 pieces. Press Accept**

After following these instructions, and setting all values as desired, press **Return to Application**.



4.2.5 Statistics for Parts Counting

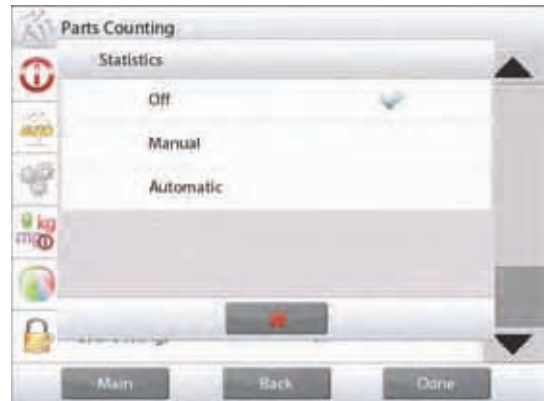
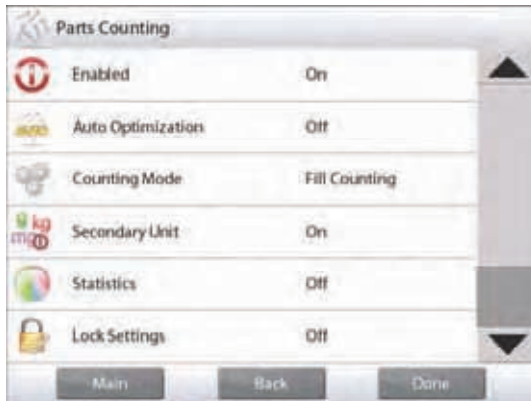
Use the Statistics function to compare a number of samples and examine the relative deviation of the samples along with other statistical data. A minimum of three samples is required.

Statistics can be determined manually (**Manual** mode, with key press after each step) or automatically (**Auto** Mode: weights are automatically recorded when stable). To use the statistics function, enable it first in the Application Setup menu.

Application Setup

First, Enable Statistics

Touch the Setup Icon wrench (as above) to enter Setup menu.



Press **Statistics** and choose either **Manual** or **Automatic**, then press **Close**. Press **Done** on the main options menu to return to the home screen.

Accumulating displayed values & Viewing data – Manual

Once Statistics is enabled, two buttons appear on the Application screen; **Statistics** and **Accumulate**.

To add the sample to the data set, place the item on the pan and press **Accumulate**.

When stable, the Statistics button lights briefly to show the item is added to the set and the data set quantity increments by one.



Continue to add items and press **Accumulate** to build the statistical data set

At any time, press the **Statistics** button to view the results.



The Statistics Results screen

Press **Print** to send to the enabled COM port

Press **Close** to return to the Application home screen with the current statistics set or

Press **Clear Data** to clear the results and return to the Application home screen.



Statistics – Automatic

Statistics Automatic mode is similar to manual mode (above) except the first stable weight is automatically captured. Thus the Accumulate button is not used.

4.3 Percent Weighing

Use Percent Weighing to measure the weight of a sample displayed as a percentage of a pre-established Reference Weight.

The default (or last) Reference Weight is displayed.

Place an object on the pan. The difference between the sample and the Reference Weight is displayed as both a weight and a percentage.

To Access Percent Weighing:

Press the upper left portion of the home screen, so the available Application Modes are visible. Select **Percent Weighing**.



The **Percent Weighing** Home Screen appears.



The **PERCENT WEIGHING** Home screen

Main Display Line
Second Display Line

Reference Fields

Application Buttons
Functions



Application Icon

4.3.1 Edit Settings

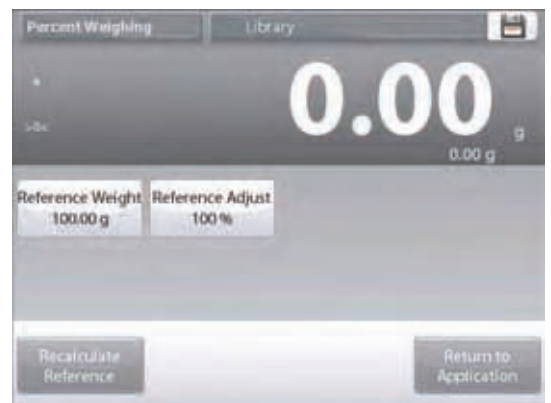
To view or adjust the current settings

To adjust the Application settings, touch the **Edit Settings** button. (See above.)

The Settings screen is now displayed.

Settings available: **Reference, Reference Adjust**

Functions Available: **Recalculate Reference, Return to Application**

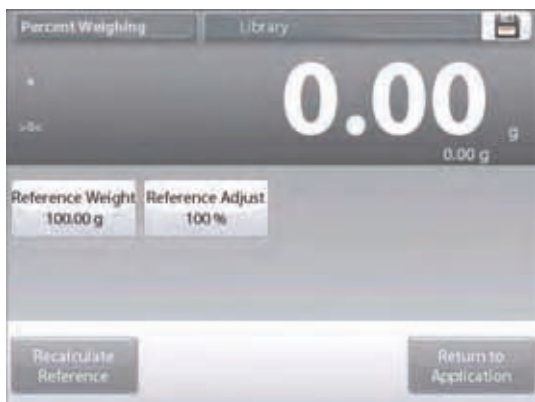


Establishing a Reference Weight

There are two methods to establish the Reference Weight value:

1. **Direct:** If the actual Reference Weight is known, it can be entered directly;
2. **Derived:** The sample's weight can be used to establish the reference weight.

Establishing a Known Reference Weight



The current Reference weight value is shown on the Settings screen. To adjust the Reference weight directly, touch the **Reference** button.



A numeric input window appears.

Key in the desired Reference Weight, then press ✓.

The display returns to the previous screen with the new value highlighted.

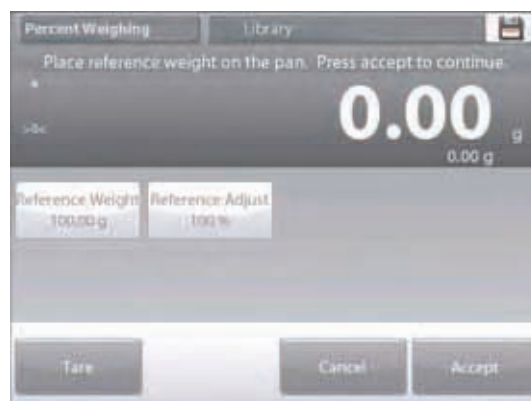
To return to the Percent Weighing home screen, touch **Return to Application**.

Using a Sample to Establish a Derived Reference Weight



To establish a new Reference weight value, touch the **Recalculate Reference** button.

The **New Reference** screen appears. Follow the screen instructions to establish a new Reference Weight.



Actions available: **Tare**, **Cancel**, or **Accept**.

Press **Accept** to capture the value and return to the Settings screen.

The display returns to the Settings screen with the new Reference weight value highlighted momentarily.

To return to the Percent weighing home screen, touch **Return to Application**.

Reference Weight Adjustment (Reference Adjust)

The Reference Weight adjustment can be 1 to 1000 percent.

Examples: 100% means the sample is displayed as compared to 100% of the Reference Weight.

25% means the sample is displayed as compared to 400% of the Reference Weight.

The **Edit Settings** screen shows current Reference Adjust value. To change it, touch **Reference Adjust** button.



A numeric input window appears.

Key in the desired Reference Weight Adjustment, then press **Done**.



The display returns to the previous screen with the new value highlighted momentarily.

To return to the Percent weighing home screen, touch **Return to Application**.

4.3.2 Application Setup

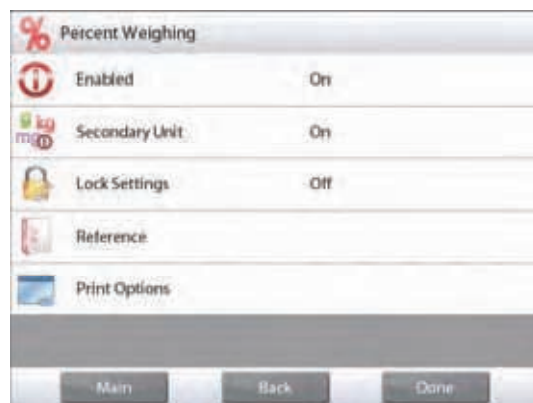
The Application can be customized for various user preferences. Press **Setup** (wrench) from the home screen.



The **Setup Menu** appears.

Select the item to view or change.

To return to the Application home screen, press **Done**.



Percent Weighing Application Setups (defaults in Bold)

Item	Available Settings	Comments
Enabled	On , Off	Turns Application on/off
Secondary Unit	On , Off	To show the Second Display line
Lock Settings	On, Off	Press to lock the current setting(s) so they cannot be changed.
Reference fields		
Reference Weight	On , Off	The Reference is displayed
Difference (weight)	On , Off	Displays the Difference to the reference weight.
Difference (percent)	On , Off	Displays the Difference to the reference weight as percentage.
Gross	On, Off	Gross weight is displayed
Net	On, Off	Net weight is displayed
Tare	On, Off	Tare weight is displayed
Print Options		
Reference Weight	On , Off	
Reference Adjust	On , Off	
Difference (weight)	On , Off	
Difference (percent)	On , Off	

4.4 Check Weighing

Check Weighing is used to compare the weight of a sample against target limits. Three different modes can be selected: Over and Under, Nominal Weight Tolerance, or Nominal Percent Tolerance.

4.4.1 Standard Check Weighing (default)

In the upper left portion of the home screen, select **Check Weighing**.

The default (or last) Check weigh limits are displayed. Place objects on the pan. The **Under/Accept/Over** status is shown in the progress bar area while the actual weight of the item is shown on the main Display Line.



The **CHECK WEIGHING** Home screen

- Main Display Line
- Second Display Line
- Reference Fields
- Application Buttons
- Functions



4.4.2 Edit Settings

To view or adjust the current settings

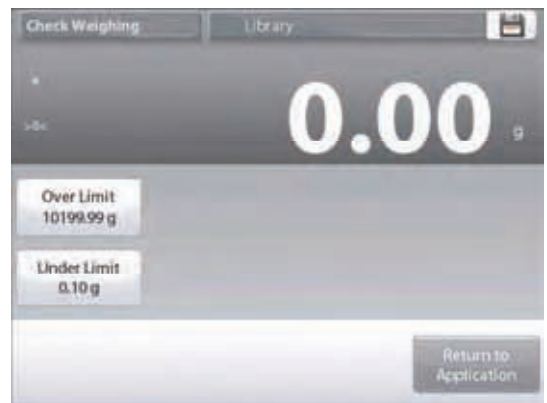
Touch the **Edit Settings** button. The Settings screen appears.
The Application Settings Screen.

Settings available: **Over Limit, Under Limit**
Functions Available: **Return to Application**

The check limit values are displayed in the settings screen.

To set the *Over Limit value*, touch the **Over Limit** button

To set the *Under Limit value*, touch the **Under Limit** button



A numeric input window appears.

Enter the desired Limit Weight, then press **OK**.

The display returns to the previous screen with the new value highlighted momentarily.

To return to the CHECK WEIGHING home screen, touch **Return to Application**.



4.4.3 Application Setup

The Application can be customized for various user preferences.

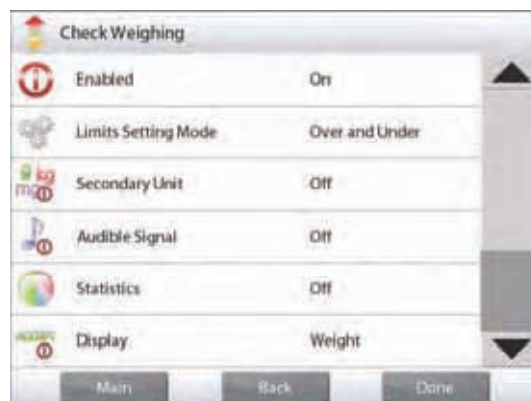
Touch the Setup Icon (wrench) to enter the Application Setup from the home screen:



The **Setup** Menu is now displayed.

Select the list item to view or change the setting as desired.

To return to the Application home screen, touch **Done**.



Check Weighing Application Setups (defaults in **Bold**)

Item	Available Settings	Comments
Enabled	On , Off	Turns Application on/off
Limits Setting Mode	Over and Under , Nominal/Weight Tol, Nominal/Percent Tol.	To select the Mode
Secondary Unit	On, Off	To show the Second Display line
Audible Signal	On , Off	Beeps if reading is <i>under</i> or <i>over</i> .
Statistics	Off , Manual, Auto	
Display Setting	Weight , Check Status	To show Weight or Check Status on Main Display Line
Lock Settings	On, Off	Press to lock the current setting(s) so they cannot be changed.
Reference fields		
Over Limit	On , Off	Over weight limit
Under Limit	On , Off	Over weight limit
Gross	On, Off	Gross weight is displayed
Net	On, Off	Net weight is displayed
Tare	On, Off	Tare weight is displayed
Target	On , Off	Used for Nominal Checkweigh
Positive Tolerance	On , Off	Used for Nominal Checkweigh
Negative Tolerance	On , Off	Used for Nominal Checkweigh
Print Options		
Over Limit	On , Off	
Under Limit	On , Off	
Target	On , Off	Used for Nominal Checkweigh
Positive Tolerance	On , Off	Used for Nominal Checkweigh
Negative Tolerance	On , Off	Used for Nominal Checkweigh

4.4.4 Check Weighing – Nominal/Weight Mode

With this feature you can establish a Target or Nominal weight value and pre-set tolerance in weight.

To enable this feature, enter the **Setup** menu.



Change the mode to **Nominal/Wt Tolerance**.
The Check Weighing options screen returns.

Press **Done** to begin Check Weighing.



CHECK WEIGHING – Nominal/Wt Tolerance home screen



Main Display Line
Second Display Line (not shown)

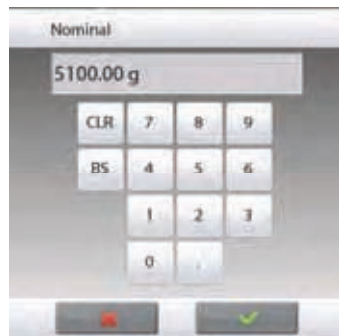
Reference Fields
Application Buttons
Functions



Application Icon

To use this mode, touch **Edit Settings** to set the **Nominal**, and **Upper** and **Lower Tolerance** values (in weight).
(See keyboards below.)

Press **Return to Application** when settings are complete.



4.4.5 Check Weighing – Nominal/Percent Tolerance Mode

With this feature you can establish a Target or Nominal weight value and pre-set tolerance in percent. To enable this feature, enter the **Setup** menu.



Change the mode to **Nominal, % Tolerance**. The Check Weighing options screen returns. Press **Done** to begin Check Weighing.



The **CHECK WEIGHING – Nominal/Percent Tolerance** home screen

Main Display Line
Second Display Line (not shown)

Reference Fields

Application Buttons

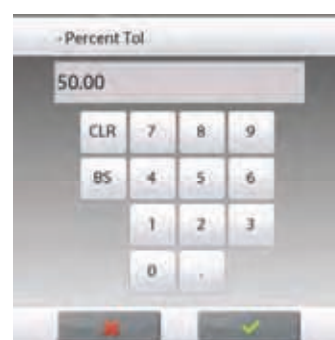
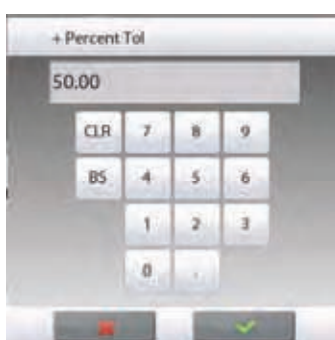
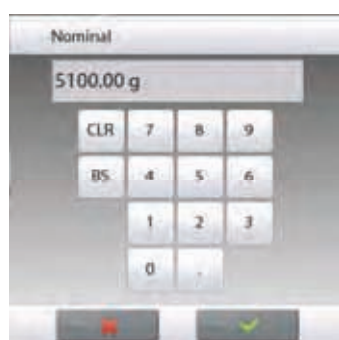
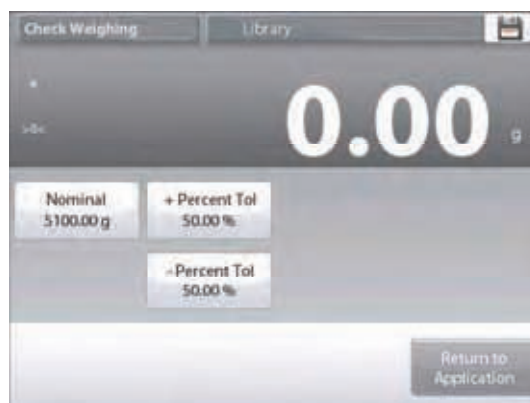
Functions



Application Icon

To use this mode, touch **Edit Settings** to set the **Target Weight**, and **Upper** and **Lower Tolerance** values (in percent). (See keyboards below.)

Press **Return to Application** when settings are complete.



4.4.6 Display Settings

The results can be displayed with the check status (**Under**, **Accept**, or **Over**) either in the Progress bar (Weighing) or in the main Weighing Line (Check Status).

To display the results in the main Weighing Line, set the Display Setting to **Check Status**, using the Application Setup screen.
(The default value is Weight.)



The **CHECK WEIGHING** home screen with Display set to **Check Status**

Main Display Line
Second Display Line

Reference Fields

Application Buttons

Functions



Application Icon

To enable **audible signals** for **Under**, **Accept**, and **Over**, Touch **Audible Signal-On** in the Application Setup screen.



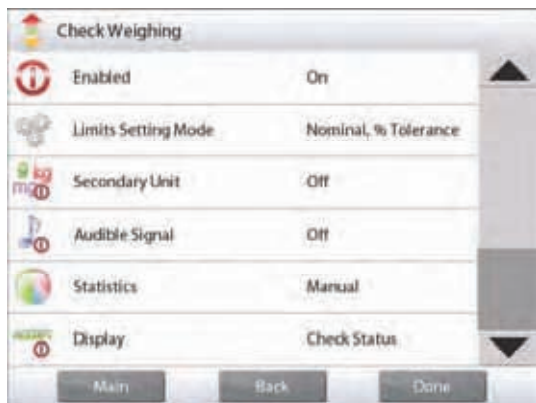
4.4.7 Statistics for Check Weighing

Use the Statistics function to compare a number of samples and examine the relative deviation of the samples along with other statistical data. A minimum of three samples is required.

Statistics can be determined **manually** (with key press after each step) or **automatically** (weights recorded automatically when stable). To use the statistics function, enable it first in the Application Setup menu.

Application Setup

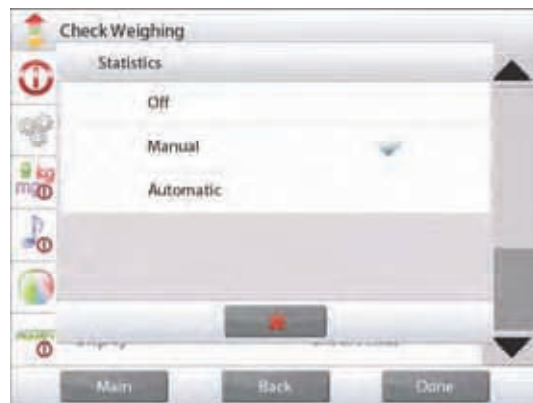
First, Enable Statistics.



Touch the **Setup** Icon wrench to enter Setup menu.



Touch **Statistics**. Choose either **Manual** or **Automatic**, then press **Done**.



Accumulating Displayed Values & Viewing Data – Manual

Once Statistics is enabled, two buttons appear on the Application screen: **Statistics** and **Accumulate**.

To add the sample to the data set, place the item on the pan and press **Accumulate**.

When stable, the **Statistics** button momentarily lights to show the item is added to the set and the data set quantity increments by one.

Continue adding items and pressing **Accumulate** to build the statistical data set

At any time, press the **Statistics** button to view the results.

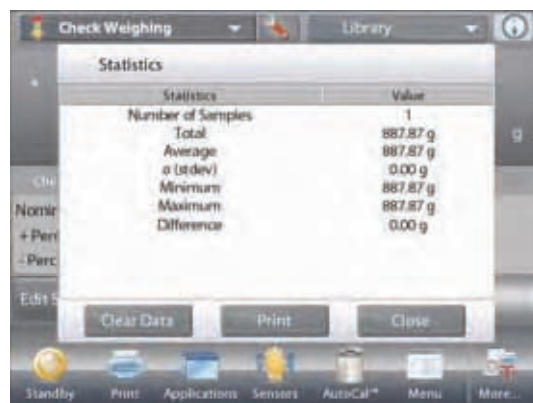


The **Statistics Results** screen

Press **Print** to send to the enabled COM port

Press **Close** to return to the Application home screen with the current statistics set.

Press **Clear Data** to clear the results and return to the Application home screen.



Statistics – Automatic

Statistics Automatic mode is similar to manual mode (above) except the first stable weight is automatically captured. Thus the Accumulate button is not used.

4.5 Dynamic/Animal Weighing

Use this application to weigh an unstable load, such as a moving animal. Three different start/reset modes can be selected: Manual (start and stop via key press), **Semi-Automatic** (auto-start with manual reset), and **Automatic** (start and stop automatically).

Dynamic Weighing – Manual (default)

To set the mode, touch the Setup wrench:

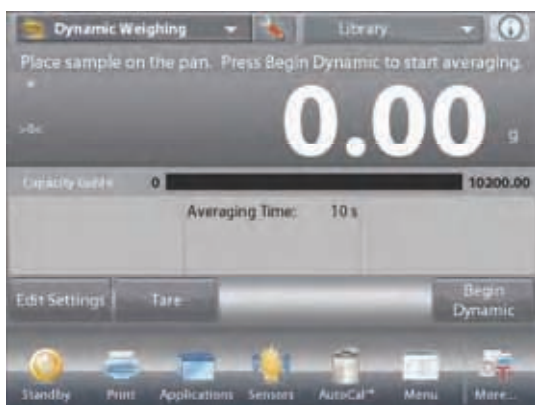
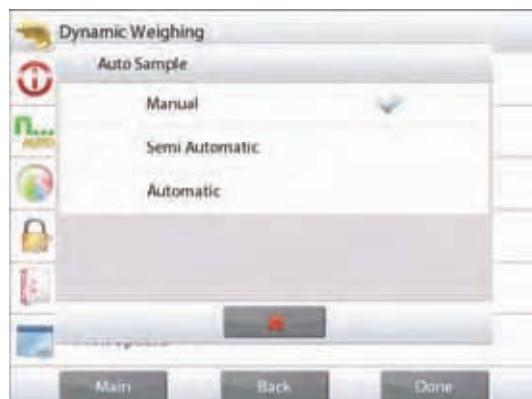


When you make a selection, the Setup options screen re-appears.

Press **Done**.

On the **Dynamic Weighing** home screen, the default (or last) Averaging Time is displayed.

Follow the screen instructions.



The **DYNAMIC WEIGHING** Home screen

Main Display Line
Second Display Line

Reference Fields

Application Buttons

Functions



Application Icon

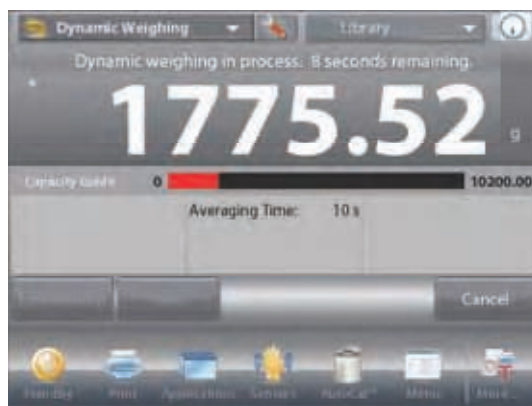
Place objects on the pan.

Press the **Begin Dynamic** button.

The balance begins a countdown (averaging process).

During the countdown, the information line displays the time remaining.

If necessary, press Cancel to quit and return to the Home screen.



When the countdown ends, the result is displayed and held.

Press **Reset** to clear the held weight and return to the Initial screen.

Note: Clear the pan before beginning a new Dynamic Weighing cycle.



4.5.1 Edit Settings

To view or adjust the current settings:

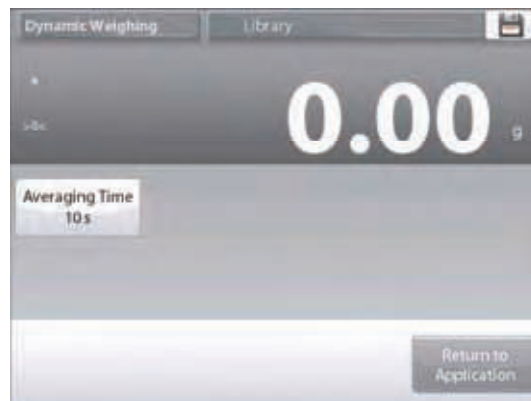
Press the **Edit Settings** button.
(See Home Screen, previous page.)
The Settings screen appears.

The **Application Settings** Screen.

Settings available: **Averaging Time**

Functions Available: **Return to Application**

The Averaging Time can be set from 1 to 99 seconds.
The default value is 10. To change it, press the button.



A numeric input window is displayed.

Key in the desired Averaging Time, then press **Done**.
The display returns to the previous screen with the new value highlighted.

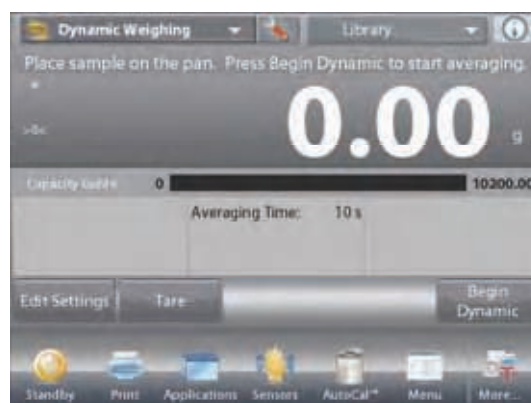
To return to the Dynamic Weighing home screen,
touch **Return to Application**.



4.5.2 Application Setup

The Application can be customized for various user preferences.

Touch the Setup wrench to enter the Application Setup from the home screen.



The **Setup** Menu appears.

Select the list item to view or change the setting as desired.

To return to the Application home screen, press **Done**.



Dynamic Weighing Application Setups (defaults in Bold)

Item	Available Settings	Comments
Enabled	On , Off	Turns Application on/off
Auto Sample Mode	Manual , Semi Automatic Automatic	To select the Mode
Statistics	Off , Manual, Auto	
Lock Settings	On, Off	Press to lock the current setting(s) so they cannot be changed.
Reference fields		
Averaging Time	On , Off	Time in Seconds
Gross	On, Off	Gross weight is displayed
Net	On, Off	Net weight is displayed
Tare	On, Off	Tare weight is displayed
Print Options		See Printing Section.
Averaging Time	On , Off	

4.5.3 Dynamic Weighing – Semi-Auto

The cycle begins when an object (animal) is placed on the pan, but the held value must be reset manually.

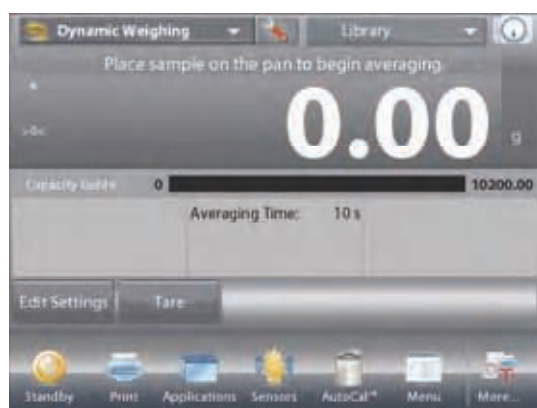
To enable this feature, touch the Setup Icon (wrench) in the top-center of the main screen to enter the **Dynamic Weighing Setup** menu.



Change the mode to **Semi Automatic**.

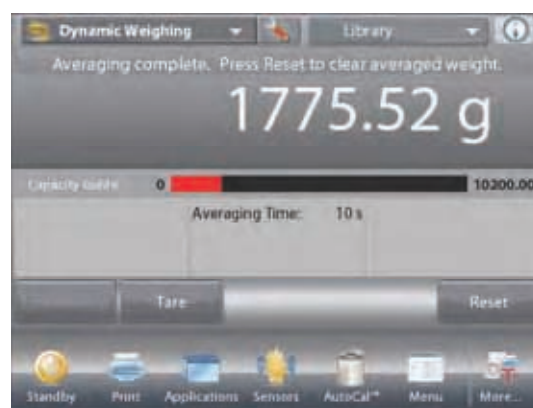


The **Dynamic – Semi-Automatic** screen appears with the default (or last) Averaging Time displayed.



Place specimen on the Pan. The cycle starts automatically.

After the cycle ends, the weight reading is held. Press the **Reset** button to clear the reading and return to zero.



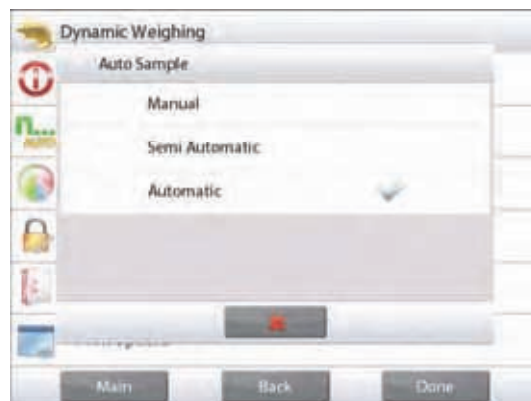
4.5.4 Dynamic Weighing – Automatic

The cycle begins when an object (animal) is placed on the pan, and the held value is automatically reset when the object is removed from the pan (10-second delay).

To enable this feature, enter the Dynamic Weighing Setup menu.



Press **Auto Sample**, and change the mode to **Automatic**.



The **Dynamic – Automatic** screen appears with the default (or last) Averaging Time displayed.

Place objects on the pan to begin.

The cycle starts automatically.



After the cycle ends, remove the specimen and the balance returns to the Home screen automatically (after a 10-second delay).



4.5.5 Statistics for Dynamic Weighing

Use the Statistics function to compare a number of samples and examine the relative deviation of the samples along with other statistical data. A minimum of three samples is required.

Statistics can be determined manually (**Manual** mode, with key press after each step) or automatically (**Automatic** Mode: weights are automatically recorded when stable). To use the statistics function, enable it first in the Application Setup menu.

Application Setup

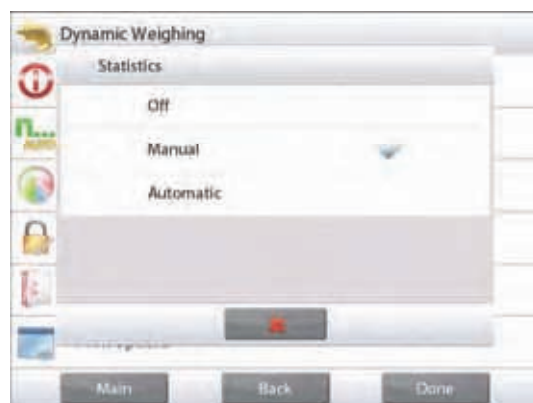
First, Enable Statistics



Touch the **Setup** Icon wrench to enter Setup menu.



Press **Statistics**. Choose either **Manual** or **Automatic** mode, then press **Done**.



Accumulating Displayed Values & Viewing Data – Manual

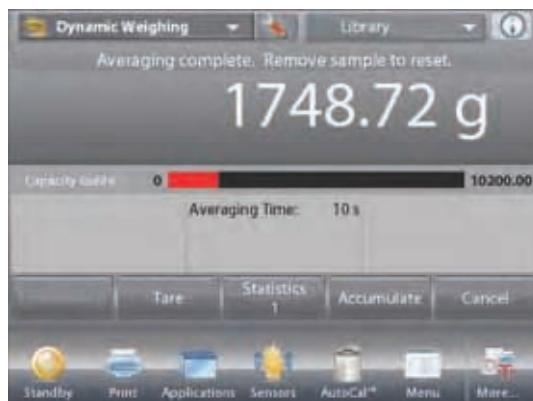
Once Statistics is enabled, two buttons appear on the Application screen: **Statistics** and **Accumulate**.

To add the sample to the data set, place the item on the pan and press **Accumulate**.

When stable, the **Statistics** button momentarily lights to show the item is added to the set and the data set quantity increments by one.

Continue adding items and pressing **Accumulate** to build the statistical data set

At any time, press the **Statistics** button to view the results.



The **Statistics Results** screen

Press **Print** to send to the enabled COM port

Press **Close** to return to the Application home screen with the current statistics.

Press **Clear Data** to clear the results and return to the Application home screen.



Statistics – Automatic

Statistics Automatic mode is similar to manual mode (above) except the first stable weight is automatically captured. Thus the Accumulate button is not used.

4.6 Filling

This application allows the user to slowly fill a container to a pre-determined target weight. The progress bar displays the filling status, and within 10 percent of the target value the progress bar converts to fine resolution (+/- 10%) for accurate results.

In the upper left portion of the home screen, select **Filling**.

The default (or last) Target weight is displayed. Place objects on the pan to begin.



The **FILLING** Home screen

Main Display Line

Second Display Line

Reference Fields

Application Buttons

Functions



Application Icon

The progress bar displays the filling status, and within 10 percent of the target value, the progress bar converts to fine resolution display.

4.6.1 Edit Settings

To view or adjust the current settings:

Touch the **Edit Settings** button.

The Settings screen appears:

Settings available: **Target Weight**

Functions Available: **Recalculate Target Weight,**
Return to Application

Establish a Target Weight

Each time a new item is used for filling, the Target Weight (fill-to weight) must be established.

There are two (2) methods to establish the Target Weight:

1. The actual Target Weight is known; or
2. The Target Weight can be derived from a sample.

Establish using a Known Target Weight

The current Target Weight appears on the **Settings** screen, on the **Target Weight** button. (See above.)

To adjust the Target weight value directly, touch the **Target Weight** button.

A numeric input window appears.

Enter the desired Target Weight, then press **Done**.

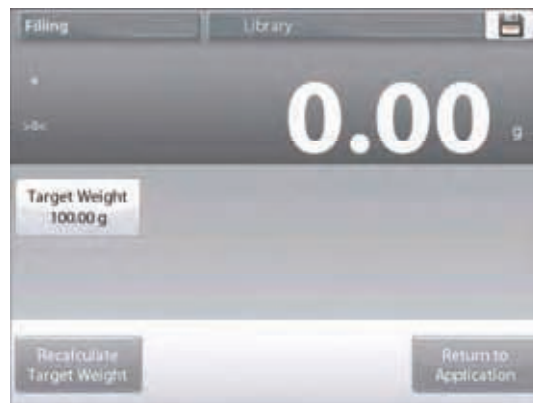
The display returns to the previous screen with the new value highlighted.

Press **Return to Application** to go to the **Filling** home screen.



Using a Sample to establish new Target Weight - Derived

To establish a new Target Weight value, press the **Recalculate Target Weight** button.



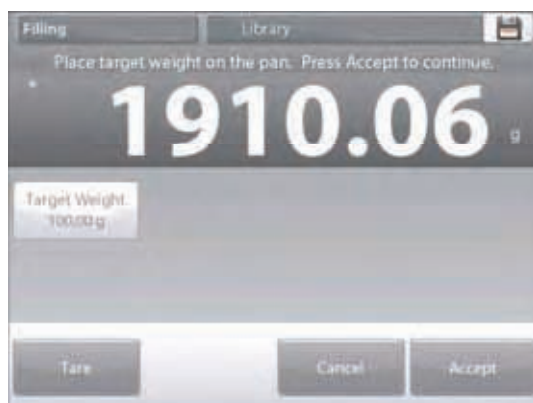
The New Target Screen appears, with a message:

Place the target weight on the pan. Press Accept to continue.

Place the weight on the pan (or in a tared container).

Press **Accept** to return to the Settings screen.

The display returns to the Settings screen with the new Target Weight value highlighted momentarily.



To return to the Filling home screen, touch **Return to Application**.

4.6.2 Application Setup

The Application can be customized for various user preferences.

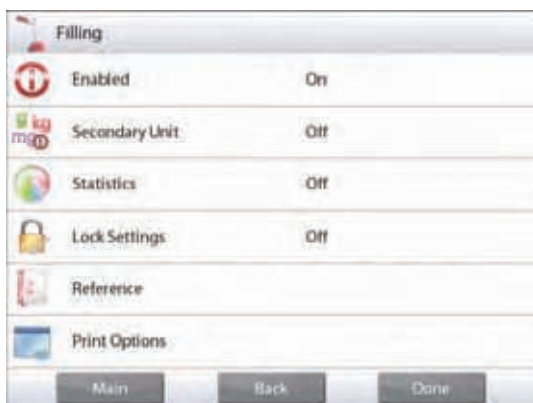
Touch the **Setup** Icon (wrench) to enter the Application Setup menu from the home screen.



The Setup Menu appears.

Select the list item to view or change the setting as desired.

To return to the Application home screen, touch **Done**.



The Filling Application Setups (defaults in Bold)

Item	Available Settings	Comments
Enabled	On , Off	Turns Application on/off
Secondary Unit	On, Off	To show the Second Display line
Statistics	Off , Manual, Auto	
Lock Settings	On, Off	Press to lock the current setting(s) so they cannot be changed.
Reference fields		
Target Weight	On , Off	The Target weight is displayed
Difference (Weight)	On , Off	Displays the Difference to the Target weight
Difference (Percent)	On , Off	Displays the Difference to the Target weight
Gross	On, Off	Gross weight is displayed
Net	On, Off	Net weight is displayed
Tare	On, Off	Tare weight is displayed
Print Options		
Target Weight	On , Off	
Difference (Weight)	On , Off	
Difference (Percent)	On , Off	

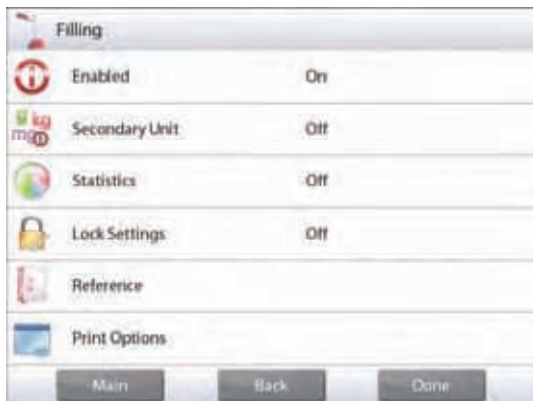
4.6.3 Statistics for Filling

Use the Statistics function to compare a number of samples and examine the relative deviation of the samples along with other statistical data. A minimum of three samples is required.

Statistics can be determined manually (**Manual** mode, with key press after each step) or automatically (**Automatic** Mode: weights are automatically recorded when stable). To use the statistics function, enable it first in the Application Setup menu.

Application Setup

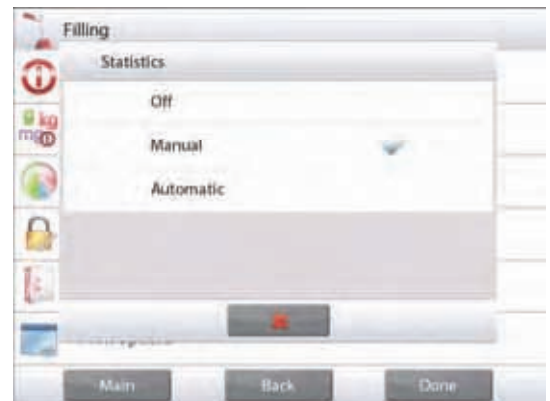
First, Enable Statistics



Touch the Setup Icon wrench (see below) to enter Setup menu.



Touch **Statistics**.
Choose either **Manual** or **Automatic** mode, then press **Done**.



Accumulating Displayed Values & Viewing Data – Manual

Once Statistics is enabled, two buttons appear on the Application screen: **Statistics** and **Accumulate**.

To add the sample to the data set, place the item on the pan and press **Accumulate**.

When stable, the **Statistics** button momentarily lights to show the item is added to the set and the data set quantity increments by one.

Continue adding items and pressing **Accumulate** to build the statistical data set

At any time, press the **Statistics** button to view the results.

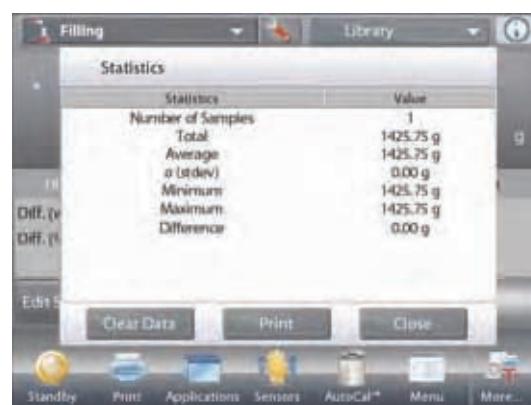


The **Statistics Results** screen

Press **Print** to send to the enabled COM port

Press **Close** to return to the Application home screen with the current statistics set.

Press **Clear Data** to clear the results and return to the Application home screen.



Statistics – Automatic

Statistics Automatic mode is similar to manual mode (above) except the first stable weight is automatically captured. Thus the Accumulate button is not used.

4.7 Totalization

Totalization measures the cumulative weight of a sequence of items. Two different Totalization accumulation modes can be selected: **Manual** accumulation (requires key press) and **Automatic** accumulation. The cumulative total may exceed the capacity of the Balance.

4.7.1 Totalization – Manual (Default)

Touch the upper left portion of the home screen. A drop-down menu appears. Select **Totalization** if it is present. (If not, touch the **Menu** icon in the bottom-left corner, then choose **Application Modes**, scroll down to find **Totalization**, press it, then press **Enabled** to turn it **On**. It will now appear in the Application Modes menu on the home screen.

Place objects on the pan to begin.



The **TOTALIZATION** Home screen

Main Display Line
Second Display Line

Reference Fields

Application Buttons

Functions



Application Icon

The sample weight is shown on the Main Display Line.
Press **Accumulate** to add the weight of the item to the total.
When stable, the new total is shown on the secondary Display Line.
Remove the item from the weighing pan, then add the next item and continue as above.
When finished, press the **Clear Total** button to reset the Second Display Line to zero.



4.7.2 Application Setup

The Application can be customized for various user preferences.

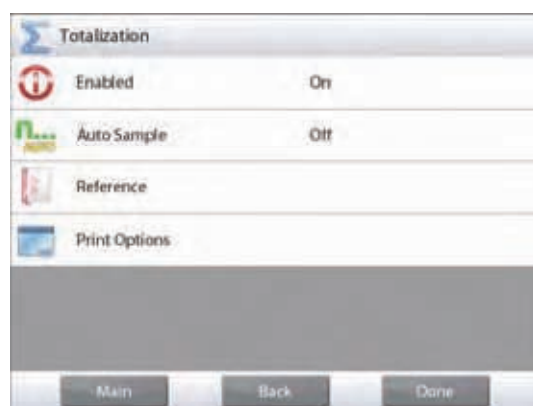
Touch the Setup Icon (wrench) to enter the Application Setup from the home screen.



The Setup Menu appears.

Select the list item to view or change the setting as desired.

To return to the Application home screen, touch **Done**.



The Totalization Application Setups (defaults in Bold)

Item	Available Settings	Comments
Enabled	On , Off	Turns Application on/off
Auto Sample Mode	On, Off	To select the mode
Reference fields		
Samples	On , Off	To display the number of samples weighed
Average (weight)	On , Off	Displays the Average
Standard deviation	On , Off	Displays the standard deviation
Minimum (weight)	On , Off	Displays the Minimum value
Maximum (weight)	On , Off	Displays the Maximum value
Range	On , Off	Displays the Range
Gross	On, Off	Gross weight is displayed
Net	On, Off	Net weight is displayed
Tare	On, Off	Tare weight is displayed
Print Options		See Printing Section.
Samples	On , Off	
Average (weight)	On , Off	
Standard Deviation	On , Off	
Minimum (weight)	On , Off	
Maximum (weight)	On , Off	
Range	On , Off	

4.7.3 Totalization – Automatic

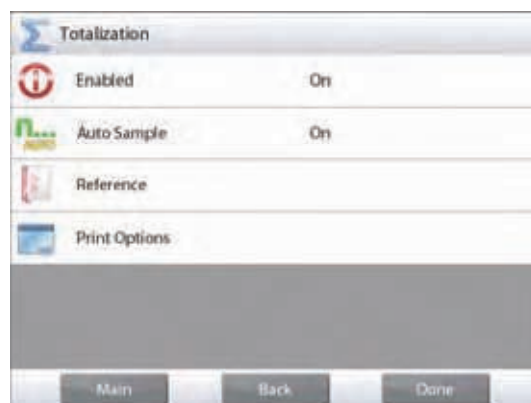
The weight of the item is added automatically (when stable).

To enable this feature:

1. Touch the Setup Icon (wrench) to enter Application Setup.



2. Press **Auto Sample** to turn this feature **On**.



Clear the pan (if necessary). Add a new sample.
The item weight is shown on the Main Display Line.

The weight of the item is automatically added (when stable) to the total. The new total is shown on the Second Display Line.

Remove the item from the weighing pan, then add the next item and continue the same as in manual mode.

When finished, press the **Clear Total** button to reset the Second Display line to zero.

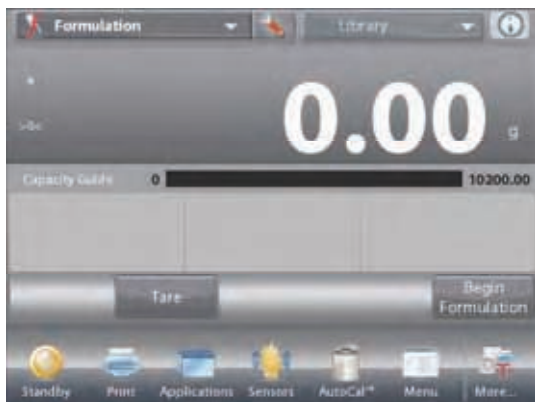


4.8 Formulation

Use this application for compounding and recipe making. The number of components can be 2 to 99. Formulation has two available modes of operation: **Free Formulation** and **Recipe Formulation**.

4.8.1 Free Formulation (default)

This mode of Formulation allows the user to freely add components. A filler material is asked for at the end. In the upper left portion of the home screen, select **Formulation**.



The **FREE FORMULATION** Home screen

Main Display Line
Second Display Line

Reference Fields

Application Buttons

Functions



Application Icon

To start the compounding process, press **Begin Formulation**.

A prompt says **Place component 1 then press Accept**.

The item weight is displayed on the main display Line.

Place the first ingredient on the pan (or in a tared container).

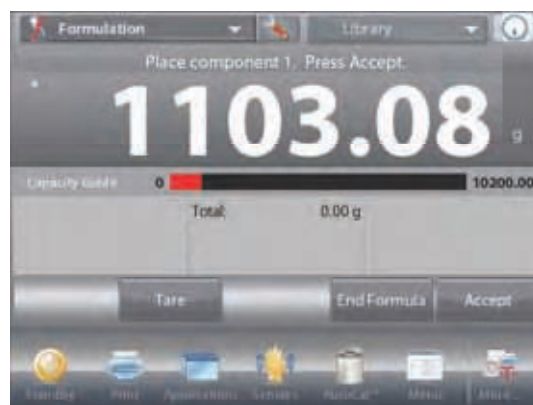
Press **Accept** to store the first component.

A prompt says **Place item 2. Press Accept**.

Continue adding components and pressing **Accept** to store the weight of the individual components until the formula is complete.

The **Total** line shows the total weight of all the components.

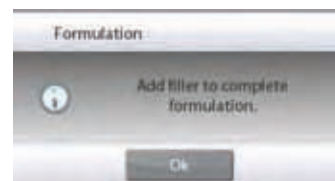
Press **Print** at any time in the process to print the recipe.



Then press **End Formula**.

The display may prompt for a Filler material.

If the formula calls for a filler material, press **OK**.



A popup message window appears, prompting for the Filler Material to be added.

Add the filler if needed, then press **Accept**.

(If no filler is needed, press **Accept** *without* adding filler.)

The results are then displayed in a pop-up window.

Free - Formulation Results

Press **Print** to send data to the enabled COM port

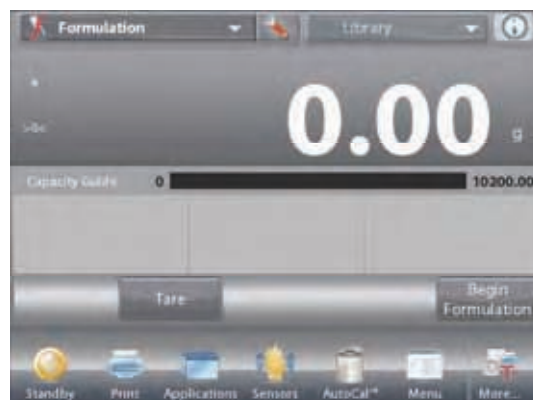
Press **Close** to close the Results window and return to the Application home screen



4.8.2 Application Setup

The Application can be customized for various user preferences.

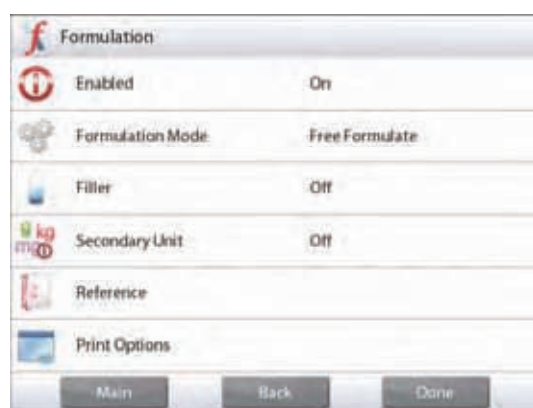
Touch the **Setup** icon (wrench) to enter **Application Setup** from the home screen.



The **Setup Menu** appears.

Select the list item to view or change the setting as desired.

To return to the Application home screen, touch **Done**.



The Formulation Application Setups (defaults in Bold)

Item	Available Settings	Comments
Enabled	On , Off	Turns Application on/off
Mode	Free Formulate , Recipe Based	To select the mode
Filler	On, Off	To prompt for a filler material
Secondary Unit	On, Off	To show the Second Display line
Reference fields		
Total	On , Off	Total is displayed
Gross	On, Off	Gross weight is displayed
Net	On, Off	Net weight is displayed
Tare	On, Off	Tare weight is displayed
Target	On , Off	For Recipe Based mode
Difference (weight)	On , Off	For Recipe Based mode
Difference (percent)	On , Off	For Recipe Based mode
Print Options		
See Printing Section.		
Total	On , Off	
Target	On , Off	For Recipe Based mode
Difference (weight)	On , Off	For Recipe Based mode
Difference (percent)	On , Off	For Recipe Based mode

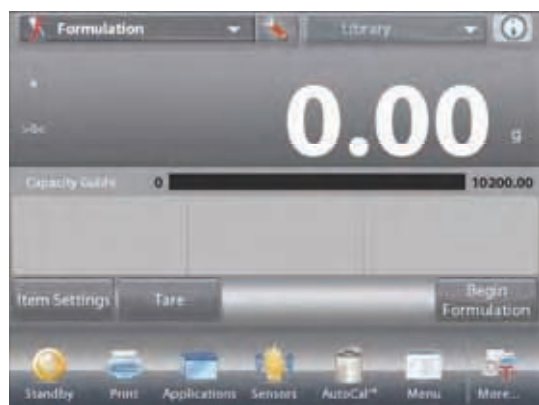
4.8.3 Recipe Formulation

Recipe Formulation requires the formula to be entered first, followed component by component.

To enable this feature, press the Setup icon (wrench) to enter the Formulation Setup menu.



Change the mode to **Recipe Based**. Press **Done** in the main setup options screen.



The **RECIPE FORMULATION** Home screen

Main Display Line
Second Display Line

Reference Fields

Application Buttons

Functions



Application Icon

Press **Begin Formulation**.

If no items have been previously set up, the Settings screen appears.

If items already exist in memory, Formulation begins.

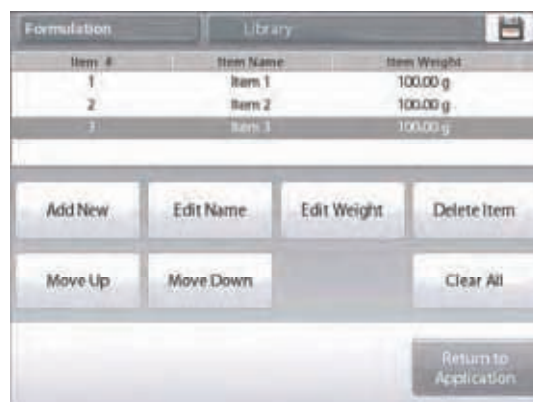
Press the **Add New** button.

A new default component is added to the end of the Formula (default Name, Weight).



To change the default component Name, Press **Edit Name**.

The alpha-numeric entry screen appears.



Enter the new name, then press ✓.

The display returns to the previous screen with the new value highlighted momentarily.



To change the default component weight, press **Edit Weight**.

The numeric entry screen appears.

Enter the new weight, then press ✓.



The display returns to the previous screen with the new value highlighted momentarily.

Continue adding components as required for your formula.

To change the order of a component in the formula, touch the item to highlight it, then press **Move Up** or **Move Down**.

To delete a component, touch the item to highlight it, and press **Delete Item**.

To clear all components, press **Clear All**. A confirmation is required.

When finished, press **Return to Application**.



Press **Begin Formulation**. Follow the screen instructions:

Add the required component in the formula.

The component weight is shown on the Main Display Line.

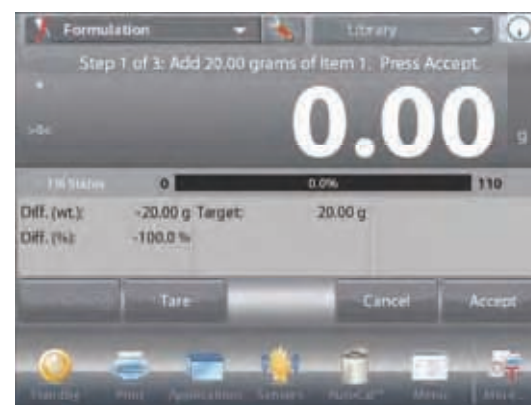
The progress bar displays the fill status. Within 10 percent of the target value the progress bar converts to fine resolution display.

Press **Accept** to add the weight of the component to the total. The new total appears on the Second Display Line.

The Difference to the target is displayed for each component (in weight and percent).

Follow the screen instructions to continue adding components and pressing **Accept** to complete the Formula.

When finished, the Formulation Results screen is displayed.



Formulation Results

Press **Print** to send the results to the enabled COM port.

To close the Results window and return to the Application home screen, press **Close**.

Item Name	Target	Actual	Diff%
Item 1	20.00 g	215.19 g	976.0 %
Item 2	100.00 g	215.19 g	115.2 %
calcium	100.00 g	215.19 g	115.2 %
Total	220.00 g	945.57 g	193.4 %

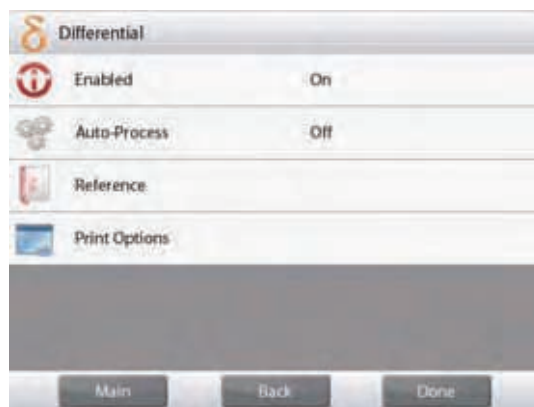
4.9 Differential Weighing

Differential weighing stores weight values so samples can be dried or processed and the difference in weight calculated. Up to 99 samples can be stored.

Differential weighing has two operating modes:

- **Auto-Process On**, where the initial and final weights are sequentially gathered for a one item; and
- **Auto-Process Off**, where initial weights are gathered for a set of items, then all the final weights for each item are gathered afterwards.

Touch the **Setup** icon (wrench) to enter **Application Setup** from the home screen.



The **DIFFERENTIAL WEIGHING** Home screen

Main Display Line
Second Display Line

Reference Fields

Application Buttons

Functions

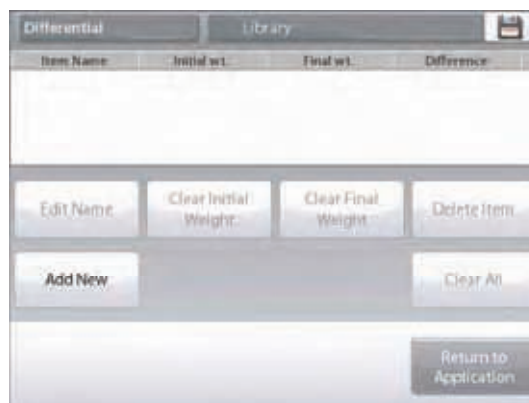


Application Icon

4.9.1 Item Settings

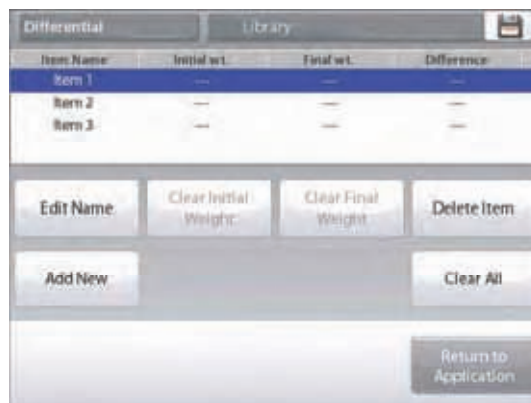
Press **Item Settings** to set up items in memory.

To set up the item, **Press Add New**.



New items are added with default name and weight information
(no initial or final weights).

To change the default Item Name, press **Edit Name**.
The alpha-numeric entry screen appears.



Enter the new name, then press ✓.

The display returns to the previous screen with the new value highlighted momentarily.



Continue adding items as required using **Add New**.
New items can be added at any time.

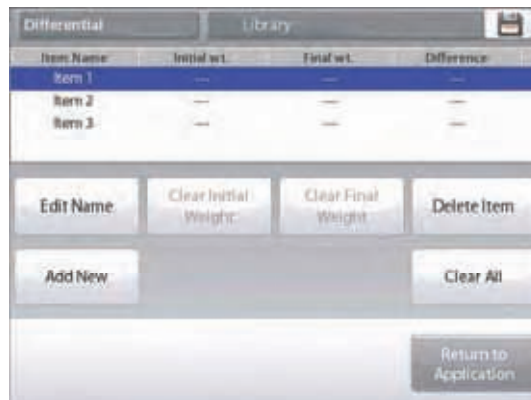
To delete an item, touch the item to highlight it,
then press **Delete Item**.

To Clear the item initial weight press **Clear Initial Weight**.
(This feature is disabled if no initial weight is stored.)

To Clear the item's final weight, press **Clear Final Weight**.
(This feature is disabled if no final weight is stored.)

To clear all items, press **Clear All**, then confirm.

When finished, press **Return to Application**.

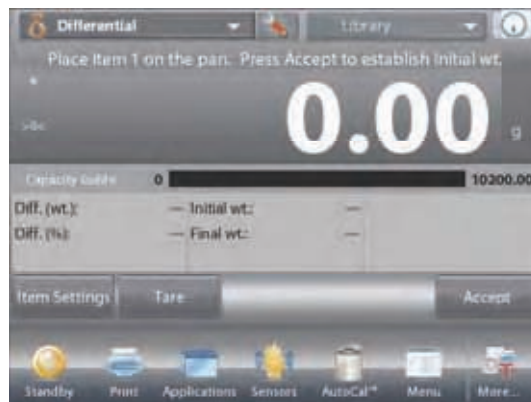


On the main Application screen, follow the screen instructions:
Add the first item, then press **Accept** to store the value.

The initial weights of the defined item are recorded first, then
the final weights of the items are collected next.

Once the items initial weight and a final weight are stored, the
values are displayed along with the Difference in weight and
percent.

The items are stored in memory. To begin a new Differential
weighing session, delete the initial and/or final weights.



4.9.2 Application Setup

The Application can be customized for various user preferences.

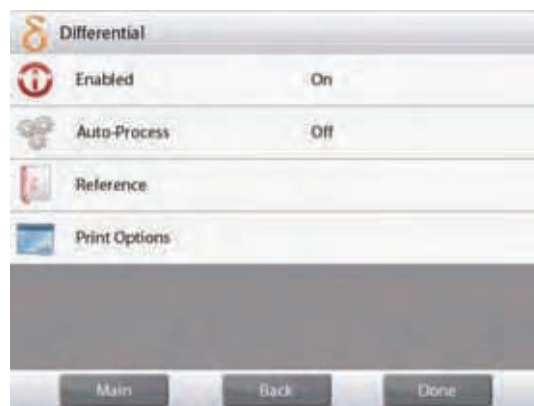
Touch the **Setup** icon (wrench) to enter **Application Setup** from the home screen.



The **Setup** Menu appears.

Select the list item to view or change the setting as desired.

To return to the Application home screen, touch **Done**.



The Differential Weighing Application Setups (defaults in Bold)

Item	Available Settings	Comments
Enabled	On , Off	Turns Application on/off
Auto-Process Mode	On , Off	To select the mode
Reference fields		
Initial Weight	On, Off	The initial weight is displayed
Final Weight	On , Off	The final weight is displayed
Difference (Weight)	On , Off	Displays the Difference to initial in weight
Difference (Percent)	On , Off	Displays the Difference to initial in percent
Gross	On, Off	Gross weight is displayed
Net	On, Off	Net weight is displayed
Tare	On, Off	Tare weight is displayed
Print Options		See Printing Section.
Initial Weight	On , Off	
Final Weight	On , Off	
Difference (Weight)	On , Off	
Difference (Percent)	On , Off	

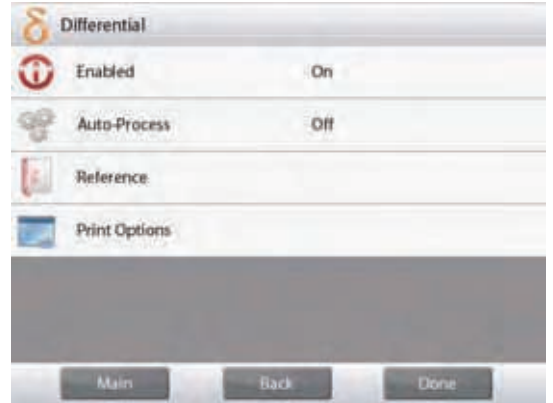
4.9.3 Differential Weighing with Auto-Process On

Differential weighing with Auto Process On requires the initial and final weights to be sequentially gathered for a single item.

To enable this feature, touch the **Setup** icon (wrench) from the home screen to enter **Application Setup**.



Press **Auto Process** to turn it **On**.



Follow the screen instructions to begin.



The **DIFFERENTIAL WEIGHING – Auto** Home screen

Main Display Line
Second Display Line (not shown)

Reference Fields

Application Buttons

Functions



Application Icon

Follow the screen instructions:

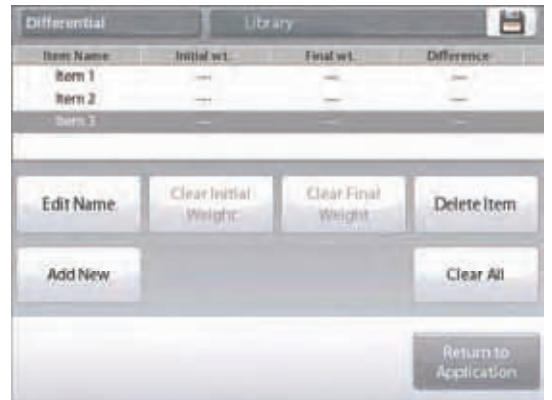
Press **Item Settings** to set up items in memory if necessary.

Use the buttons as necessary.

Follow the same steps as shown on page 57.

Press **Return to Application** when ready.

A message prompts for Item 1 to be placed on the pan again, then to press **Accept to establish Final Weight**.



After **Accept** is pressed, the difference between initial and final weights appears in the Reference Fields.

A message prompts to start the process again, if desired.



4.10 Density Determination

The Explorer can be used to determine an object's density. Four types of density determination can be made:

1. Solids *more* dense than water
2. Solids *less* dense than water
3. Liquid density
4. Porous material (impregnated with oil)

A density determination kit is designed to be used with Ohaus Explorer balances. Illustrations in this procedure refer to the density kit. However, you may use whatever lab apparatus that suits the requirements for density measurements. The balance software includes a built-in reference density table for water at temperatures between 10°C and 30°C. Review this entire section before attempting density measurements.

When making density measurements the material should weigh at least 10 mg on an analytical balance and 100 mg on a precision balance.

Density can be determined **manually** (with a key press after each step) or **automatically** (weights are automatically recorded). Before making density measurements, establish the Application Settings.



The **DENSITY DETERMINATION** Home screen

Main Display Line
Second Display Line (not shown)

Reference Fields

Application Buttons

Functions



Application Icon

4.10.1 Measuring the Density of a Solid Using Water (default)

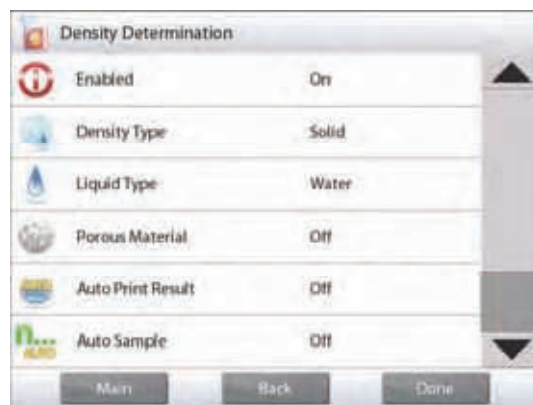
Press the **Setup** button (the wrench) to open the Density Determination **Settings** screen.



Confirm the following **Setups** are selected:

- ✓ **Density Type: Solid**
- ✓ **Liquid Type: Water**
- ✓ **Porous Material: Off**

Press **Done** to return to the Density Determination home screen.



The **Edit Settings** Screen.

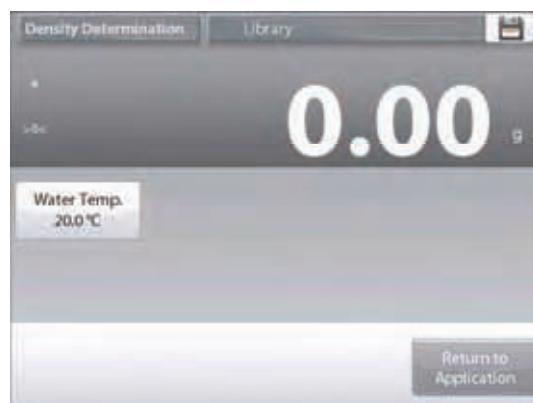
Settings available: **Water Temp**

Functions Available: **Return to Application**

To adjust the water temperature value, touch the **Water Temp** button.

The balance calculates water density based on the water temperature value entered (internal lookup table).

Measure the actual water temperature using a precision thermometer.



A numeric input window appears.

Enter the actual water temperature, then press **Done**.

The display returns to the previous screen with the new value highlighted.

To return to the Density Determination home screen, touch **Return to Application**.

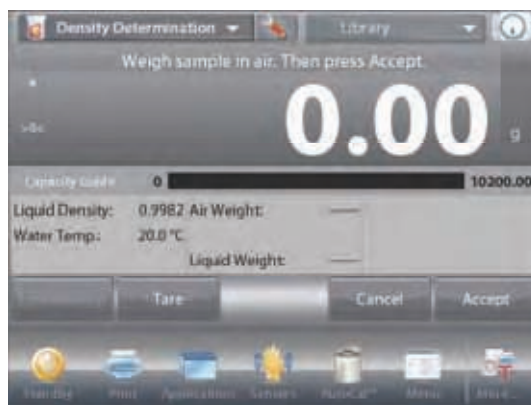
To begin the Density Determination process, press **Begin Density Determination**.

(See below.)



Step 1 of 2 – Weigh the Sample in Air.

Press **Begin Density Calculation**. Follow screen instructions, then press **Accept** to store the dry sample weight ("in air").



Step 2 of 2 – Weigh the Sample Submerged in the Liquid.

Follow the screen instructions, then press **Accept** to store the sample weight (submerged in liquid).



Once the necessary weights have been determined, the density of the sample is displayed in **g/cc** (along with the weight in air, weight in water) on the Application screen.

Press **Begin Density Determination** to reset all the weight values and restart the process.

4.10.2 Application Setup

The Application can be customized for various user preferences.



Touch the **Setup** Icon (wrench) to enter Application Setup from the home screen.



The **Setup Menu** appears.

Select the list item to view or change the setting as desired.

To return to the Application home screen, touch **Done**.

The Density Application Setups (defaults in Bold)

Item	Available Settings	Comments
Enabled	On , Off	Turns Application on/off
Density Type	Solid , Liquid	To select either solid or liquid
Liquid Type	Water , Other	Liquid used during measurements
Porous Material	On, Off	To select Porous material
Auto Print Result	On, Off	To automatically print results
Auto Sample Mode	On, Off	To select the mode
Reference fields		
Liquid Density	On , Off	Test liquid's density is displayed
Water Temperature	On , Off	The water temp is displayed
Oil density	On , Off	The test oil's density is displayed
Weight in Air	On , Off	The sample weight is displayed
Oiled Weight	On , Off	The sample weight is displayed
Weight in Liquid	On , Off	The sample weight is displayed
Sinker volume	On , Off	Displays volume of the Sinker
Print Options		
Porous Material	On , Off	
Liquid Type	On , Off	
Liquid Density	On , Off	
Water Temperature	On , Off	
Weight in Air	On , Off	
Weight in Liquid	On , Off	

4.10.3 Measuring the Density of a Buoyant Material Using Water

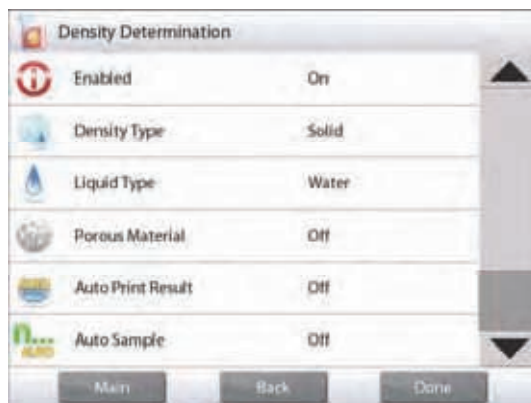
Press the **Setup** button (the wrench) to open **Settings** screen.

Confirm the following **Setups** are selected:

- ✓ **Density Type: Solid**
- ✓ **Liquid Type: Water**
- ✓ **Porous Material: Off**

Press **Done** to return to the Density Determination home screen.

Follow the same procedure as Solid Material above, except in Density Determination step 2, **push the sample down** into the liquid until it is fully submerged.



4.10.4 Measuring the Density of a Solid Using an Auxiliary Liquid

To enable this feature, enter the Density Setup menu and select the following:

Density Type: Solid; Liquid Type: Other; Porous Material: Off. See Application Setup.



The **DENSITY DETERMINATION – SOLID** Home screen

Main Display Line
Second Display Line

Reference Fields

Application Buttons

Functions



Application Icon

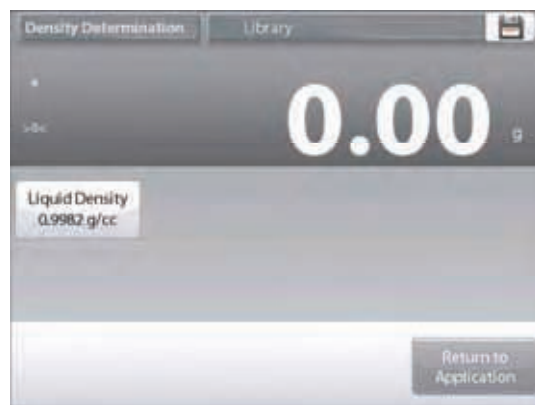
Confirm the default values displayed (Liquid Density, etc) are correct.

To edit the default values, touch **Edit Settings** and the application Settings screen appears.

Settings available: **Liquid Density**

Functions Available: **Return to Application**

To adjust the Liquid Density value, touch the **Liquid Density** button.



Measure the actual liquid density of the Density setup and enter it.

A numeric input window appears.

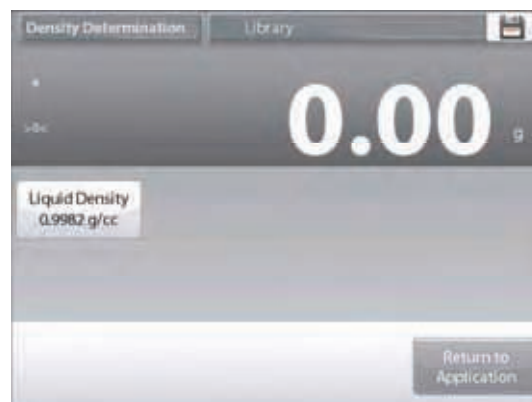
Key in the density in g/cc, then press **Done**.

The display returns to the previous screen with the new value highlighted.



To return to the Density Determination home screen, touch **Return to Application**.

Begin the Density determination process as per above.



4.10.5 Measuring the Density of a liquid using a Calibrated Sinkers (not supplied)

Enable this feature, enter the Density Setup menu and select the following; **Density Type: Liquid**. (See Application Setup.)

Note: when the Density Type is set to Liquid, the Liquid type and Porous material selections are disabled.



The **DENSITY DETERMINATION – LIQUID** Home screen

Main Display Line
Second Display Line

Reference Fields

Application Buttons

Functions



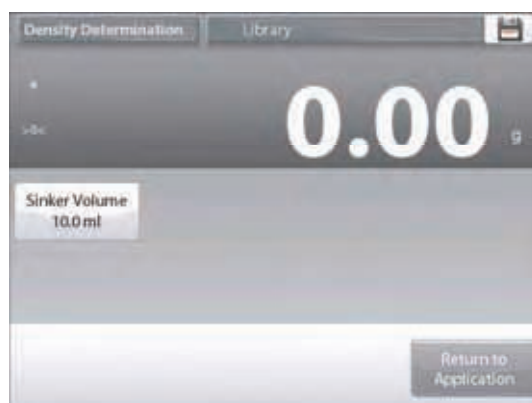
Application Icon

Confirm that the default value displayed (sinker volume) is correct. To edit the default values, touch **Edit Settings** and the Settings screen is now displayed:

Settings available: **Sinker Volume**

Functions Available: **Return to Application**

To adjust the Sinker volume value, touch the **Sinker Volume** button.



A numeric input window is displayed.

Key in the desired value, then press ✓.

The display returns to the previous screen with the new value highlighted.

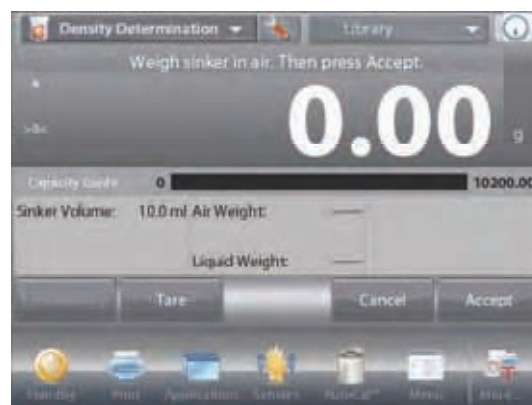
To return to the Density Determination home screen, touch **Return to Application**.

Press **Begin Density Determination** to start the process.



Step 1 of 2 – Weigh the Sinker in Air.

Follow the screen instructions, then press **Accept** to store the sinker weight (“in air”).



Step 2 of 2 – Weigh the Sinker Submerged in the Test Liquid.

Follow the screen instructions, then press **Accept** to store the sinker weight (submerged in liquid).



Once the necessary weights have been determined, the density of the Liquid sample is displayed in **g/cc** (along with the weight in air, weight in water) on the Application screen.

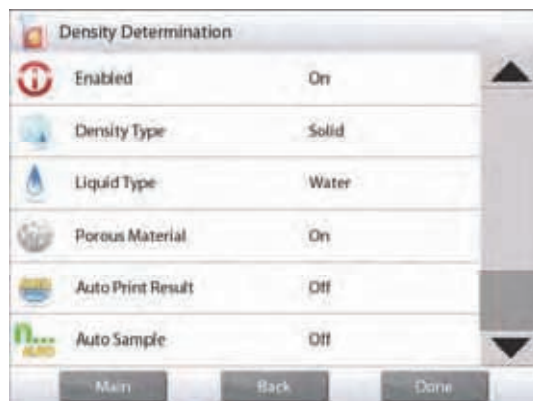
Press **Begin Density Determination** to reset all the weight values and restart the process.



4.10.6 Measuring the Density of Porous Material Using Oil

To enable this feature, enter the Density Determination Setup menu, and set the following:

- ✓ **Density Type: Solid**
- ✓ **Liquid Type: Water**
- ✓ **Porous Material: On**



The **DENSITY DETERMINATION – POROUS** Home screen

Main Display Line
Second Display Line

Reference Fields

Application Buttons

Functions



Application Icon

Confirm the default values displayed (Water Temp) are correct.

To edit the default values, touch **Edit settings**.

The Settings screen appears.

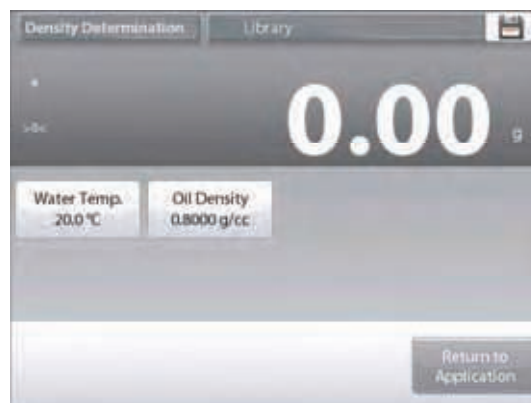
Settings available: **Water Temp, Oil Density**

Functions Available: **Return to Application**

The balance calculates water density based on the water temperature value entered (look-up table).

Measure the actual water temperature using a precision thermometer.

To adjust the Water Temperature or Oil Density values, touch the **Water Temp** or **Oil Density** button.



Numeric input windows appear.

Key in the desired value, then press ✓.

The display returns to the previous screen with the new value highlighted.

To return to the Density Determination home screen, touch **Return to Application**.



Press **Begin Density Calculation**.

Step 1 of 3 – Weigh the Un-Oiled Sample in Air.

Follow the screen instructions then press **Accept** to store the dry sample weight (in air).



Step 2 of 3 – Weigh the Oiled Sample in Air.

Follow the screen instructions then press **Accept** to store the sample weight (oiled).



Step 3 of 3 – Weigh the Oiled Sample Submerged in Liquid.

Follow the screen instructions then press **Accept** to store the oiled sample weight (submerged in liquid).



Once the necessary weights have been determined, the density of the sample is displayed in **g/cc** (along with the weight in air, un-oiled and oiled, and weight in water) on the Application screen

The value stays on the display until **Begin Density Determination** is touched.

Press **Begin Density Determination** to reset all the weight values and restart the process.



4.11 Peak Hold

The Peak Hold application allows the user to capture and store the highest stable weight in a series of weight measurements.

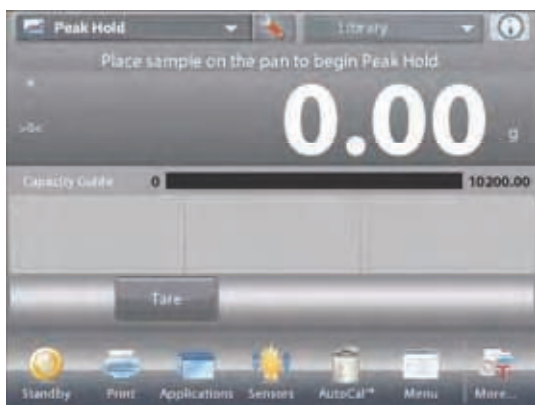
Three different start/reset modes can be selected:

- ✓ **Manual** (start and stop the capture via key press),
- ✓ **Semi-Automatic** (start automatically/reset manually); and
- ✓ **Automatic** (start and stop the capture automatically).

This application allows both stable and unstable weights to be captured.

4.11.1 Peak Hold – Semi-Automatic (default)

In the upper left portion of the home screen, select **Peak Hold**.
Follow the screen instructions to begin.



The **PEAK HOLD** Home screen

Main Display Line
Second Display Line

Reference Fields

Application Buttons

Functions



Application Icon

Place item on the pan. The capture process starts automatically.

The highest reading is held on the display.

To release the reading, press **End Peak Hold**.

The following screen appears.



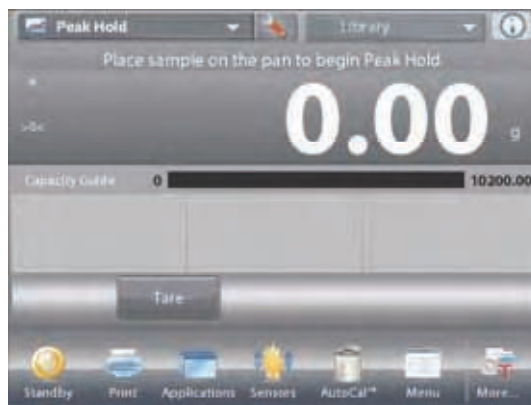
Clear the pan or press **Tare** to reset the display and re-start the process.



4.11.2 Application Setup

The Application can be customized for various user preferences.

Touch the **Setup** icon (wrench) to enter **Application Setup** from the home screen.



The **Setup Menu** appears.

Select the list item to view or change the setting as desired.

To return to the Application home screen, touch **Done**.



The Peak Hold Application Setups (defaults in Bold).

Item	Available Settings	Comments
Enabled	On , Off	Turns Application on/off
Auto Sample Mode	Manual, Semi Automatic , Automatic	To select the mode of operation
Stable Weight Only	On, Off	To capture Stable values only
Secondary Unit	On, Off	To show the Second Display line
Reference fields		
Gross	On, Off	Gross weight is displayed
Net	On, Off	Net weight is displayed
Tare	On, Off	Tare weight is displayed
Print Options		See Printing Section.
Stable Weight Only	On , Off	

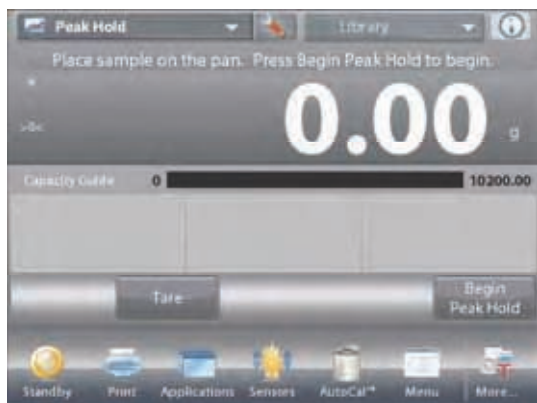
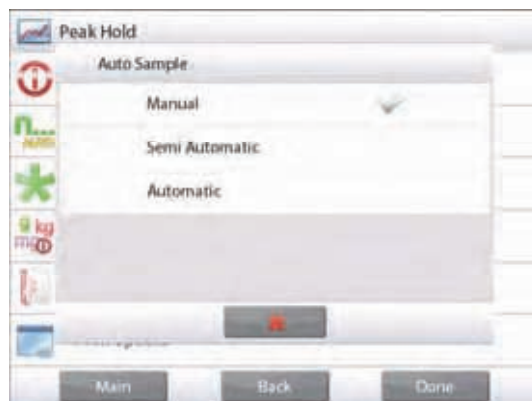
4.11.3 Peak Hold – Manual

For manual start and reset, choose **Manual** mode.

To enable this feature, enter the Peak Hold **Setup** menu:



Change the mode to **Manual**.



The **PEAK HOLD** – Manual Home screen

Main Display Line
Second Display Line

Reference Fields

Application Buttons

Functions



Application Icon

Follow the screen instructions: Place item on the pan.

Press **Begin Peak Hold** to begin the capture process.

The following screen appears:



The highest stable weight reading is held indefinitely.

Press **End Peak Hold** then clear the pan to reset the display and re-start the process.

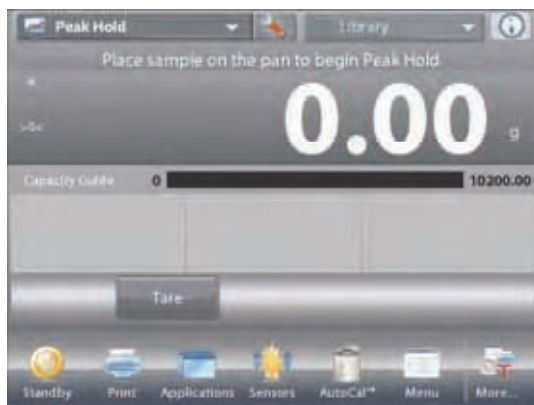
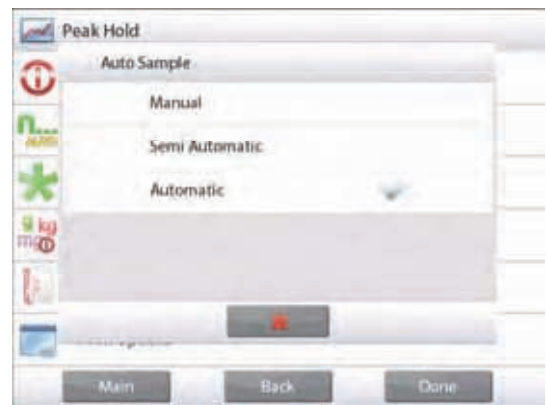


4.11.4 Peak Hold – Automatic

For automatic start and reset, choose **Automatic** mode.
 To enable this feature, enter the Peak Hold **Setup** menu.



Change the mode to **Automatic**.



The **HIGH POINT – Auto** Home screen

Main Display Line
 Second Display Line

Reference Fields

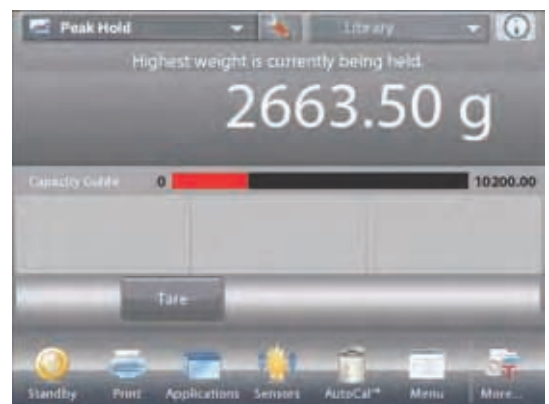
Application Buttons

Functions



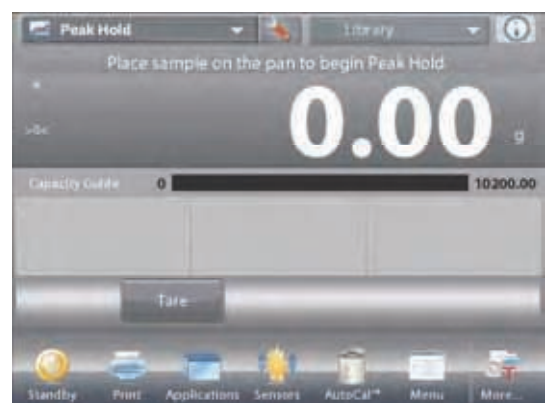
Application Icon

Place item on the pan. The capture process starts automatically.



The highest stable weight reading is held until the weight is removed.

The process starts automatically once the weight is removed from the pan (after 10 sec delay).



4.12 Ingredient Costing

This application allows the user to determine the cost of a formula or recipe based on the known cost and quantity of the components or ingredients. Up to 99 components are allowed.

In the upper left portion of the home screen, select **Ingredient Costing**. Follow the screen instructions to begin.



The **INGREDIENT COSTING** Home screen

Main Display Line
Second Display Line

Reference Fields

Application Buttons

Functions



Application Icon

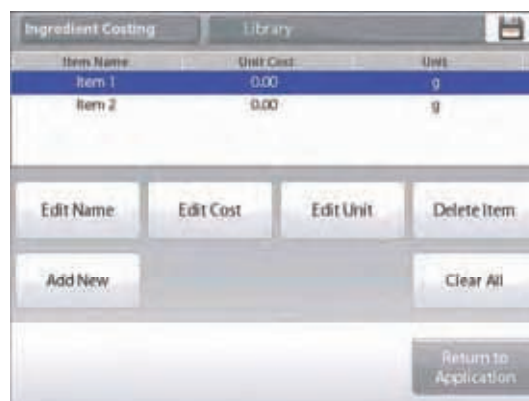
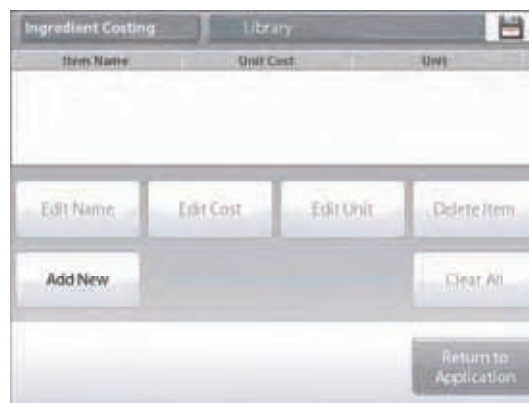
4.12.1 Item Settings

Press **Item Settings** to set up items in memory.

The **Edit Settings** Screen.

Settings available: **Add New, Edit name, Edit Cost, Edit Unit, Delete Item, Clear All**

Functions Available: **Return to Application**



To set up the item(s) in memory, Press **Add New**.

A new item is added (default Name) with default info (cost per weight and weight unit).

To change the default item name, Press **Edit Name**.

The alpha-numeric entry screen appears.

Enter the new name, then press ✓.

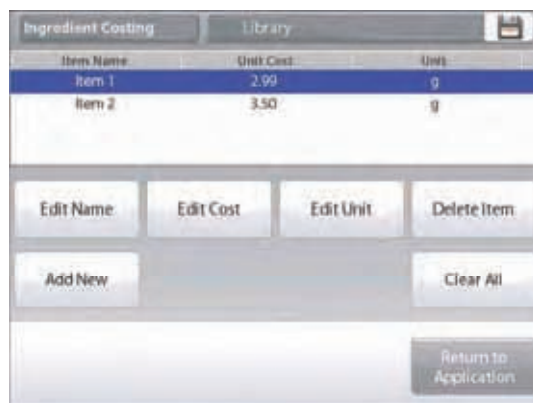
The display returns to the previous screen with the new value highlighted momentarily.



To change the default component cost per unit,

Press **Edit Cost**.

The numeric entry screen appears.



Enter the new weight, then press **Done**.

The display returns to the previous screen with the new value highlighted momentarily.



To change the default component Unit, press **Edit Unit**.

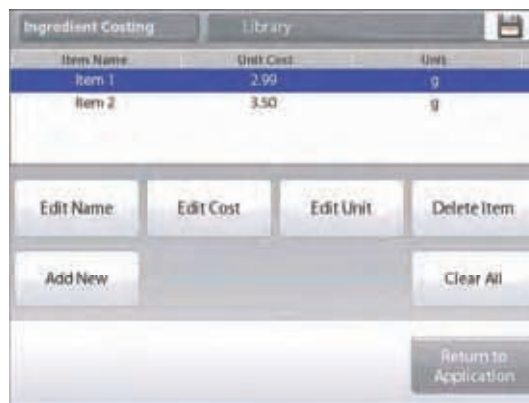
The Weighing Units screen appears.



Continue adding items as required, using **Add New**.
New items can be added at any time.

To delete an item, touch the item to highlight it,
then press **Delete Item**.

To clear all items, press **Clear All**. A confirmation is required.
When finished, press **Return to Application**.



Once setup is complete and the application screen is displayed,
follow the screen instructions:

Add the first item then press **Accept** to store the value in
memory.

The weight of the item is recorded,
then the screen prompts for the next component.

Unit Cost, Total Weight and **Total Cost** are also displayed.

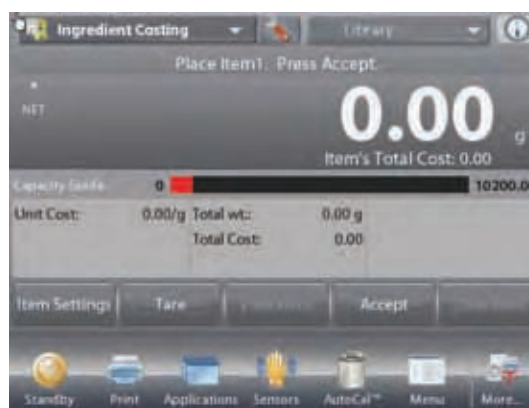


Continue follow the screen instructions to add the items to the
pan and touch the **Accept** button until each item has been
weighed.

Press the **View Data** button at any time to show the current
results: (**Item, Item Cost** and **Item Weight**).

After the last item has been weighed, press **View Data** to see
the results.

(Cancel the current data set by pressing **Clear Data**.)



Ingredient Costing Results.

Press **Print** to send the data to the enabled COM port.

Press **Close** to close the results window and return to the
Application home screen.



4.12.2 Application Setup

The Application can be customized for various user preferences.

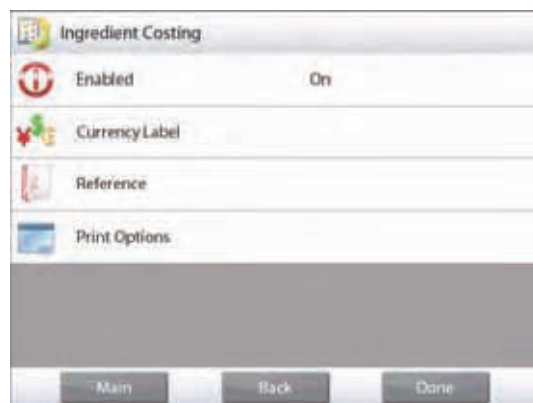
Touch the **Setup** Icon (wrench) to enter Application Setup from the home screen.



The **Setup Menu** is now displayed.

Select the list item to view or change the setting as desired.

To return to the Application home screen, touch **Done**.



The Ingredient Costing Application Setups (defaults in Bold)

Item	Available Settings	Comments
Enabled	On , Off	Turns Application on/off
Currency label	None , various	To select the Currency label
Reference fields		
Unit Cost	On , Off	To display the Item cost
Total Weight	On , Off	To display the Total weight
Total Cost	On , Off	To display the Total cost
Gross	On, Off	Gross weight is displayed
Net	On, Off	Net weight is displayed
Tare	On, Off	Tare weight is displayed
Print Options		See Printing Section.
Total Weight	On , Off	
Total Cost	On , Off	

4.13 Pipette Adjustment

Pipette adjustment checks the accuracy and precision values of pipettes by weight analysis. The balance has a built-in density reference table for water at temperatures between 10°C and 30°C. If other liquids are used for pipette calibration, enter the liquid's density at current room temperature in g/cc. Since all calculations are made within the balance, the atmospheric pressure is also required.

Pipette adjustment can be accomplished **manually** (with a key press after each step) or **automatically** (weights are automatically recorded when stable). Calculations made within the balance provide results of inaccuracy and imprecision. Up to 30 samples can be used.



The **PIPETTE ADJUSTMENT** Home screen

Main Display Line
Second Display Line

Reference Fields

Application Buttons

Functions



Application Icon

4.13.1 Pipette Adjustment – Manual (default)

Confirm the default values displayed are correct:
Nominal, Inaccuracy, Imprecision, Density, Atmospheric Pressure, Water Temperature, etc.

To edit the default values, touch the **Edit Settings** button.

The **Edit Settings** Screen.

Settings available: **Nominal Capacity, Water Temp, Inaccuracy, Atmospheric Press, Imprecision, Pipette Name, Pipette Number**

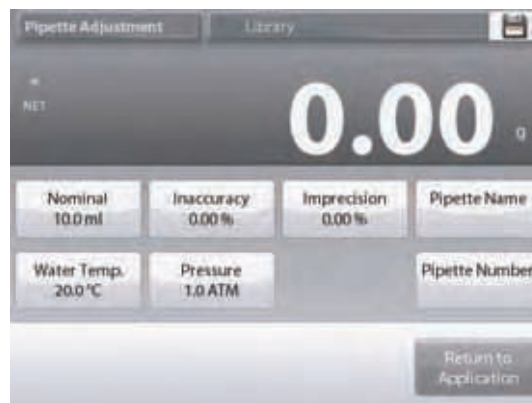
Functions Available: **Return to Application**

To adjust the pipette Nominal Capacity value, touch the **Nominal** button.

Enter the Nominal Capacity in the keyboard screen that appears, and press ✓.

The display returns to the previous screen with the new value highlighted.

Note: Capacity can be measured in *mL* or *uL*, depending on the Application Setup.



To adjust the water temperature, touch the **Water Temp** button.

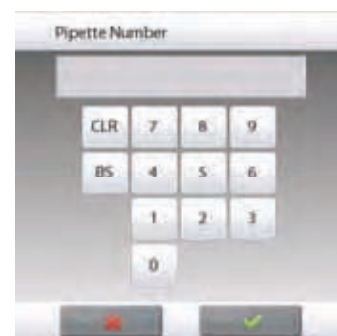
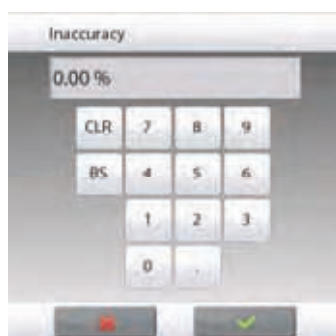
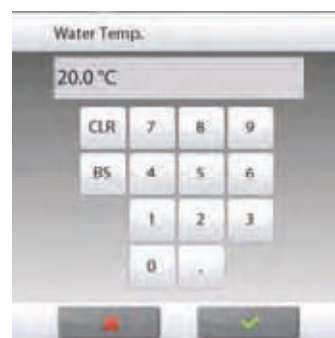
The balance calculates water density based on the water temperature value entered. Measure the actual water temperature using a precision thermometer.

A numeric input window is displayed.

Key in the desired temperature, then press **Done**.

The display returns to the previous screen with the new value highlighted.

Continue to enter the required information following the above procedure:



Pipette Inaccuracy, via the **Inaccuracy** button

Barometric Pressure, via the **Barometric Pressure** button

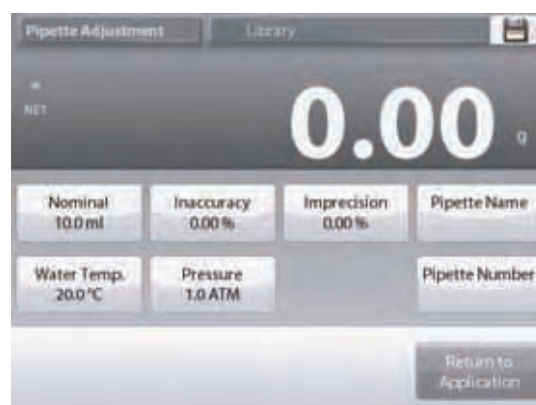
Pipette Imprecision, via the **Imprecision** button

Pipette Name, via the **Pipette Name** button

Pipette Number, via the **Pipette number** button

When finished, press **Return to Application**.

The Application home screen appears, and you can begin the Pipette Adjustment process.



4.13.2 Begin Pipette Adjustment Process



Touch **Begin Pipette Adjustment**. Follow the screen instructions, to **Place container on the pan**. Then **Press Tare**.



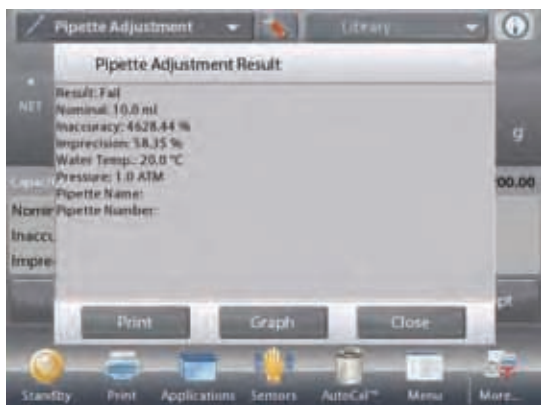
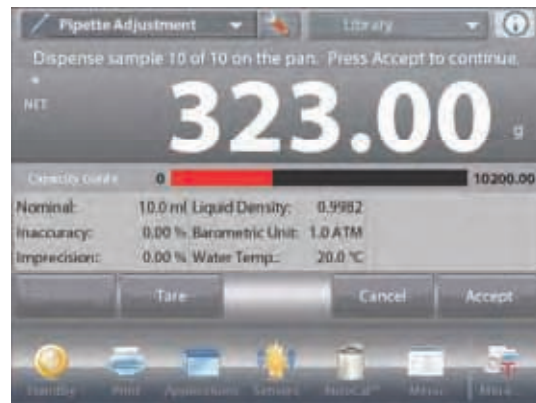
Step 1 – Dispense the First Sample

Follow the screen instructions, then press **Accept** to store the first sample weight (liquid).



Continue to follow the screen instructions by dispensing samples and pressing **Accept** to store each sample weight (liquid).

The default number of samples is 10. It can be changed in Setup, from 2 to 30 samples.



Once all the sample weights have been dispensed, the **Results** screen is automatically displayed.

Press **Graph** to see results plotted. Press **Result** to return to the result screen. Press **Close** to return to the Pipette Adjustment home screen.



Note: To view either the results or graph screens again from the home screen, press the **View Result** button. To start a new Pipette Adjustment process, press **Begin Pipette Adjustment**.

4.13.3 Application Setup

The Application can be customized for various user preferences.

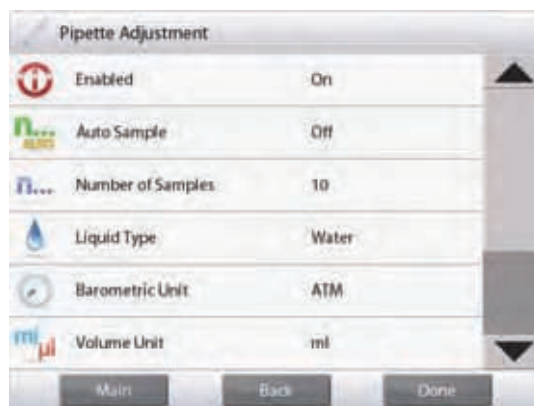
Touch the **Setup** Icon (wrench) to enter the **Application Setup** from the home screen.



The **Setup Menu** appears.

Select the list item to view or change the setting as desired.

To return to the Application home screen, touch **Done**.



The Pipette Adjustment Application Setups (defaults in Bold)

Item	Available Settings	Comments
Enabled	On , Off	Turns Application on/off
Auto Sample Mode	On, Off	To select the mode of operation
Number of Samples	2 – 30 (default 10)	To select the number of samples
Liquid Type	Water , Other	Liquid used during measurements
Unit of Pressure	ATM , inHg, KPa, mbar, mmHg, PSIA	To select Atmospheric Pressure unit
Volume Unit (Pipette capacity unit)	mL , uL	Nominal capacity unit
Secondary Unit	On, Off	To show the Second Display line
Lock Settings	On, Off	Press to lock the current setting(s) so they cannot be changed.
Reference fields		
Nominal Volume	On , Off	Nominal capacity displayed
Inaccuracy	On , Off	Inaccuracy value displayed
Imprecision	On , Off	Imprecision value displayed
Liquid Density	On , Off	Liquid density value displayed
Barometric Unit	On , Off	Barometric Pressure value displayed
Water Temperature	On , Off	Water temperature is displayed
Print Options		
Nominal Volume	On , Off	
Inaccuracy	On , Off	
Imprecision	On , Off	
Liquid Density	On , Off	
Barometric Unit	On , Off	
Water Temperature	On , Off	

4.14 Statistical Quality Control (SQC)

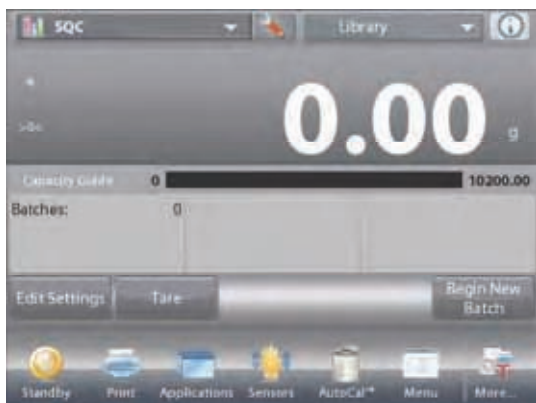
The Statistical Quality control (SQC) feature is useful during various types of process filling operations, to monitor and/or control the process to eliminate under- and over-filling.

As samples are weighed and stored in the balance, a Trend Analysis is developed and can be displayed. Up to 10 batches with up to 80 samples in a batch are visible for quality control purposes. Each batch of samples is shown, with the maximum, minimum, standard deviation and mean values for each batch. An on-going examination of the relative deviation of the samples along with other statistical data can be viewed.

The filling process operation can be effectively monitored by observing the results on the View Trace screen.

SQC collection can be done manually (**Manual** mode, requires key press after each step) or automatically (**Auto** Mode, the weights are automatically recorded when stable).

In the upper left portion of the home screen, select **SQC**.



The **SQC** Home screen

Main Display Line
Second Display Line

Reference Fields

Application Buttons

Functions



Application Icon

4.14.1 Edit Settings

Confirm the default values (**Nominal, Inaccuracy, Imprecision, Density, Atmospheric Pressure, Water Temperature, etc.**) are correct.

To view/edit the default values, touch the **Edit Settings** button. The Settings screen appears.

Settings available: **Nominal Target weight, +Tolerance 1, -Tolerance 1, +Tolerance 2, -Tolerance 2**

Functions Available: **Return to Application**

To adjust the Nominal Target weight value, touch the **Nominal** button.

A numeric input window appears.

Key in the desired Nominal Weight, then press ✓.

The display returns to the previous screen with the new value highlighted.



Continue to enter the required information following the above procedure:

Positive Tolerance 1, via the **+Tolerance 1** button.

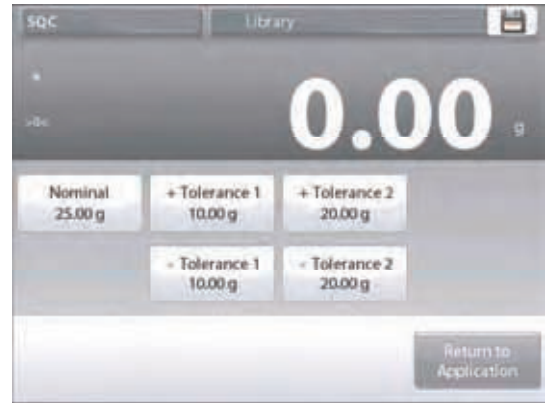
Negative Tolerance 1, via the **-Tolerance 1** button.

Positive Tolerance 2, via the **+Tolerance 2** button.

Negative Tolerance 2, via the **-Tolerance 2** button.

Tolerances can be in either weight (default) or percent – See **Application Setup**, Section 4.14.3.

When finished, press **Return to Application** and the SQC home screen appears.



4.14.2 Begin the SQC Process



Touch the **Begin New Batch** button.

First Batch: the screen prompts for the Batch name.

Enter the Batch name, then press ✓.



The Process screen is then displayed.

Follow the screen instructions, then press **Accept** to store the sample weight.

The current number of **Samples**, along with the **Average**, **Sum**, **Minimum** value, **Maximum** value, and **Range** are displayed.

Continue to follow the screen instructions by weighing samples and pressing **Accept** to store each sample's weight.

The sample size is 10 (default).

It can be changed in Setup from 2 to 80 pieces.



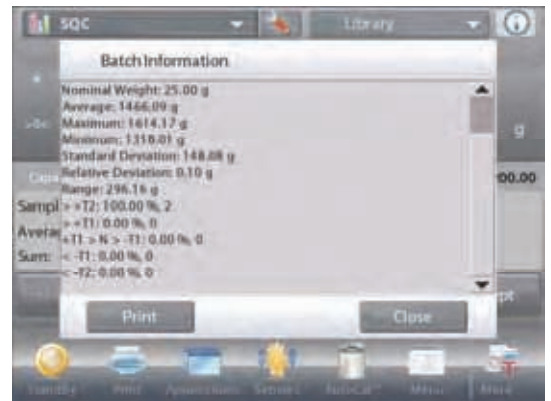
At any time, press **End Batch** to see the Individual results screen, showing results for the current Batch.

Once all the samples have been weighed, the **Results** screen appears *automatically*.

If the COM interface is enabled, press **Print** to send the results either to a computer or a printer.

Press **Close** to return to the current Batch process.

A message offers the chance to save the batch, if desired.



To view the process results of this batch (and any other saved batch), press the **View Batch History** button.

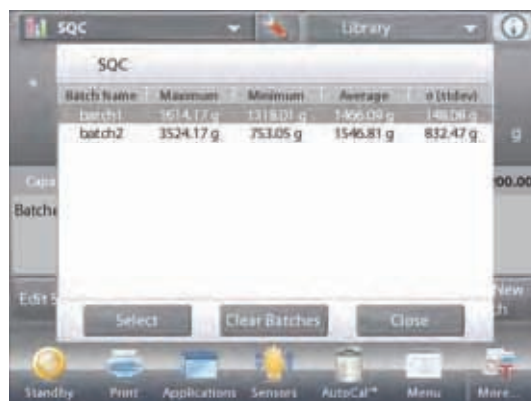


The Batch History screen shows the basic information – **Maximum, Minimum, Average** (mean), and **Standard Deviation** – for all currently saved batches.

Press **Select** to see (and print) the Batch Information screen for any saved batch.

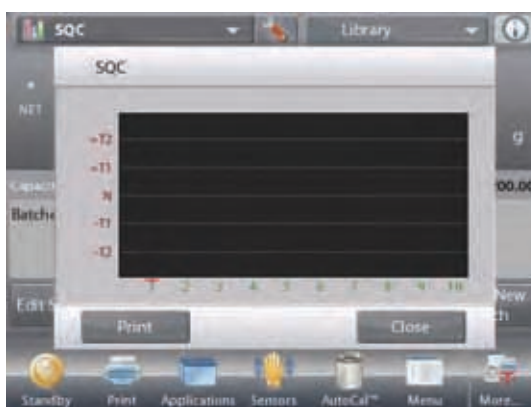
Press **Clear Batches** to reset SQC results and return to the SQC home screen

Press **Close** to return to the SQC home screen to begin another batch or to view process results.



To view the Process results graphically (batch comparison), press the **View Trace** button.

Press **Print** or **Close** as above.



4.14.3 Application Setup

The Application can be customized for various user preferences.

Touch the **Setup** Icon (wrench) to enter **Application Setup** from the home screen.



The **Setup Menu** is now displayed.

Select the list item to view or change the setting as desired.

To return to the Application home screen, touch **Done**.



The SQC Application Setups (defaults in Bold)

Item	Available Settings	Comments
Enabled	On , Off	Turns Application on/off
Number of Samples	2 – 80 (default 10)	To select the number of samples in a Batch
Tolerance Mode	Weight , Percent	Tolerance used during measurements
Auto Sample Mode	Manual , Semi Automatic, Automatic	To select the mode of operation
Lock Settings	On, Off	Press to lock the current setting(s) so they cannot be changed.
Reference fields		
Number of Batches	On , Off	The total batches
Number of Samples	On , Off	The total samples
Average	On , Off	The Average value is displayed
Total	On , Off	The Sum value is displayed
Maximum	On , Off	The Maximum value is displayed
Minimum	On , Off	The Minimum value is displayed
Range	On , Off	The Range is displayed
Print Options		
See Printing Section.		
Number of Batches	On , Off	
Number of Samples	On , Off	
Average	On , Off	
Total	On , Off	
Maximum	On , Off	
Minimum	On , Off	
Range	On , Off	

4.15 Statistics

Statistics are used to compare a number of samples and examine the relative deviation of the samples along with other statistical data. A minimum of three samples is required.

Statistics can operate **manually** (key press after each step) or **automatically** (weights automatically recorded when stable). To use the statistics feature, enable it in the Application Setup menu.

This feature is available in Weighing, Counting, Check Weighing, Dynamic Weighing and Filling applications.

4.16 Library

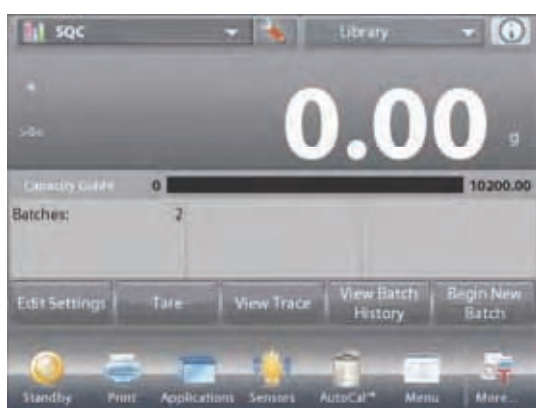
When an item is processed on a regular basis, the item's data may be stored in memory for future use. This memory is referred to as the Balance's Library.

The following data is stored for the Application used:

Application	Parameters and setups	Name	Preset Tare	APW	Ref Wt. or Target	Sample size	Under Limit	Over Limit	Level	Mode
Weighing	x	x	x							
Counting	x	x	x	x		x	x	x		x
Percent Weighing	x	x	x		x					
Check Weighing	x	x	x				x	x		x
Dynamic Weighing		x	x						x	x
Filling	x	x	x		x					
Totalization	N/A	N/A	N/A	N/A	N/A	N/A	N/A	N/A	N/A	N/A
Formulation	N/A	N/A	N/A	N/A	N/A	N/A	N/A	N/A	N/A	N/A
Differential Weighing	N/A	N/A	N/A	N/A	N/A	N/A	N/A	N/A	N/A	N/A
Density Determination	x	x	x							
Peak Hold	N/A	N/A	N/A	N/A	N/A	N/A	N/A	N/A	N/A	N/A
Ingredient Costing	N/A	N/A	N/A	N/A	N/A	N/A	N/A	N/A	N/A	N/A
Pipette Adjustment	x	x	x							
SQC	x	x	x							

4.16.1 Creating a Library Record

To create a Library record, the Settings screen is used. From the home screen, touch the **Edit Settings** button. The Settings screen is now displayed.

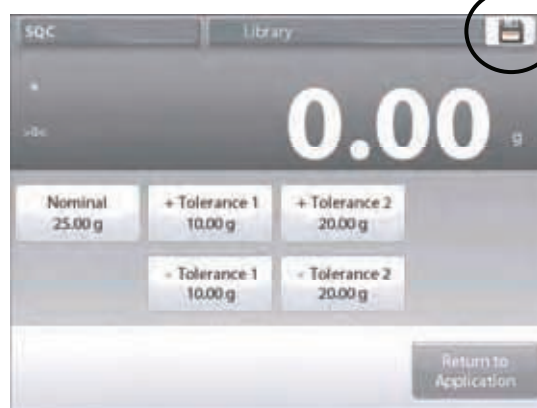


Touch the **Edit Settings** button.

The **Settings** screen appears.

Confirm the application settings; then touch **Save (the diskette, top-right)**.

An alphanumeric entry screen appears, to enter the Library Record name.



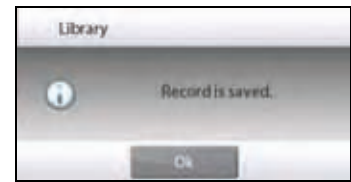


Enter the Record name, then press ✓.

Note: Library Record names can be 8 characters or less.

A **Record is saved** message appears. Press **OK**, then...

Press **Return to Application**.



4.16.2 Retrieving a Library Record

Load a Library record from the home screen.

Press the **Library** bar in the upper right area of the screen.

(It shows the name of the most recently used library file.)

The Library manager popup is now displayed.

Touch the Library Record to highlight it, then touch **Recall** to load the record's settings into the Application.

Then press **Close** to return to the home screen with the Library name displayed and the stored parameters active.



4.16.3 Deleting a Stored Library Record

To delete a stored record, follow "Retrieving a Library Record" above, but press **Delete** instead of **Recall**.

4.17 Additional Features

4.17.1 Weigh Below

The Explorer Balance is equipped with a weigh below hook for weighing below the balance.

Note: before turning the balance over, remove the Pan, Pan Support, Wind Ring/Shield and Draft Shield elements (if present) to prevent damage.



CAUTION: Do not place the balance on the pan support cone or Load cell Pins

To use this feature, remove power from the balance, then remove the protective cover for the weigh below opening (2 screws). The protective cover is reversible for easy storage.



The balance can be supported using lab jacks or any other convenient method. Ensure the balance is level and secure. Power on the Balance, then use a string or wire to attach items to be weighed.

5. MENU SETTINGS

5.1 Menu Navigation

All menu navigation is performed by touching the display. To enter the Menu, touch **Menu** from any Application Home screen. The Main menu appears, with buttons for **Main**, **Back** and **Done**. Continue touching the appropriate list item to navigate to the Menu items or touch a button to change location.



5.1.1 Changing Settings

To change a menu setting, navigate to that setting using the following steps:

Enter the Menu

From any Application screen, Touch **Menu**.
The Main Menu List appears on the display.

Select the Sub-Menu

Scroll down to the selected item of the Main Menu List and touch it. The Sub-Menu appears.

Select the Menu Item

Continue until the desired setting is chosen in the Menu list. Touch the setting to change it.
The changed setting will be displayed as highlighted for 2 seconds to confirm the changed value.



Exit the Menu and Return to the Current Application

After the setting is confirmed, touch **Done** to return to the Application.

Note: at any time the **Main**, **Back** & **Done** buttons can be touched to navigate to the desired area of the menu or return to the current Application.

5.2 Main Menu

The Explorer balance Main menu structure is illustrated below.



5.3 Calibration

Explorer Balances offer a choice of six calibration methods: Internal Calibration, AutoCal Calibration, Calibration Adjust, Span Calibration, linearity Calibration, and User Calibration.

Note: Do not disturb the balance during any calibration.

5.3.1 Calibration sub-menu



5.3.2 Internal Calibration (AutoCal™)

Calibration is accomplished with the internal calibration mass. Internal calibration can be performed at any time, provided the balance has warmed up to operating temperature and is level.

With the Balance turned ON and no load on the pan, touch **AutoCal™ Internal Calibration**. The Balance begins to calibrate.

Alternately, touch the shortcut **Calibration** Icon from any Application home screen to initiate an Internal Calibration.



The display shows the status, then returns to the current application.

To cancel at any time, press **Cancel**.

5.3.3 Automatic Calibration

When **Automatic Calibration** is set ON, the balance performs a self calibration when a measured predefined change occurs (in temperature or time). AutoCal will automatically calibrate the Balance (using the internal mass) each time a change in temperature significant enough to affect accuracy, or after every 11 hours.

5.3.4 AutoCal™ Adjustment

Use this calibration method to adjust the zero calibration point, without affecting the span or linearity calibration.

Calibration Adjust may be used to adjust the result of the Internal calibration by ± 100 divisions.

Note: Before making a calibration adjustment, perform an Internal Calibration. To verify whether an adjustment is needed, place a test mass equal to the **span calibration value*** on the pan and note the difference (in divisions) between the nominal mass value and the actual Balance reading. If the difference is within ± 1 division, calibration adjustment is not required. If the difference exceeds ± 1 division, calibration adjustment is recommended. (*See Table 5-1, below.)

Example:

Actual weight reading:	200.014
Expected weight reading:	200.000 (Test mass value)
Difference Weight (d):	0.014
Difference weight in digits:	-14 (Adjust value)

To perform a Calibration Adjustment, touch AutoCal Adjustment from the Calibration Menu; Enter the value (positive or negative divisions) to match the difference noted earlier in the procedure and press ✓.

Recalibrate using Internal Calibration. After calibration, place the test mass on the pan and verify that the mass value now matches the displayed value. If not, repeat the procedure until Internal Calibration reading agrees with the test mass.

Once completed, the balance stores the Adjustment value and the display returns to the current application.

5.3.5 Span Calibration

Span calibration uses two calibration points, one at zero load and the other at specified full load (span). Refer to Table 5.1 for Span values.

Note: Factory default settings are shown in bold.

TABLE 5-1 Calibration Masses

Model	Span Calibration Points	Weight Class	
EX124	50g, 100g	ASTM Class 1	OIML E2
EX224	100g, 150g, 200g	ASTM Class 1	OIML E2
EX324, M, N	150g, 200g, 300g	ASTM Class 1	OIML E2
EX223	100g, 150g, 200g	ASTM Class 1	OIML E2
EX423	200g, 300g, 400g	ASTM Class 1	OIML E2
EX623	300g, 400g, 500g , 600g	ASTM Class 1	OIML E2
EX1103, M, N	500g, 1000g	ASTM Class 1	OIML E2
EX2202	1000g, 2000g	ASTM Class 1	OIML E2
EX4202	2000g, 3000g, 4000g	ASTM Class 1	OIML E2
EX6202	3000g, 4000g, 5000g , 6000g	ASTM Class 1	OIML E2
EX10202, M, N	5000g, 10,000g	ASTM Class 1	OIML E2
EX6201	3000g, 4000g, 5000g , 6000g	ASTM Class 2	OIML F1
EX10201	5000g, 10,000g	ASTM Class 1	OIML E2

With the balance turned ON and no load on the pan, touch Span Calibration to initiate the procedure. Additional calibration values to be used are shown on the display. The best accuracy is achieved using the mass closest to the full span value.

Note: To change the span calibration point, touch the alternate weight shown on the display. Follow the screen instructions and place the specified calibration weight on the scale when prompted to do so. When complete, the display shows the Span calibration status and returns to the current application.

5.3.6 User Calibration

User Calibration is used to calibrate the balance using a user defined mass.

With no load on the scale, press **User Calibration** from the calibration sub-menu.

The display shows the current full load (span) calibration point and calibration unit of measure.

To change the value to a user-defined weight, touch **ENTER VALUE**.

Enter the weight via the popup screen. The balance then prompts for the User-defined weight.

Place the specified calibration weight on the balance and the calibration process completes.

The display shows status, then returns to the current application.

5.3.7 Calibration Test

Use Calibration Test to compare a known calibration weight against the stored span calibration data.

With no load on the scale, press **Cal Test** to begin the process.

The balance captures the zero point, then prompts for the span value.

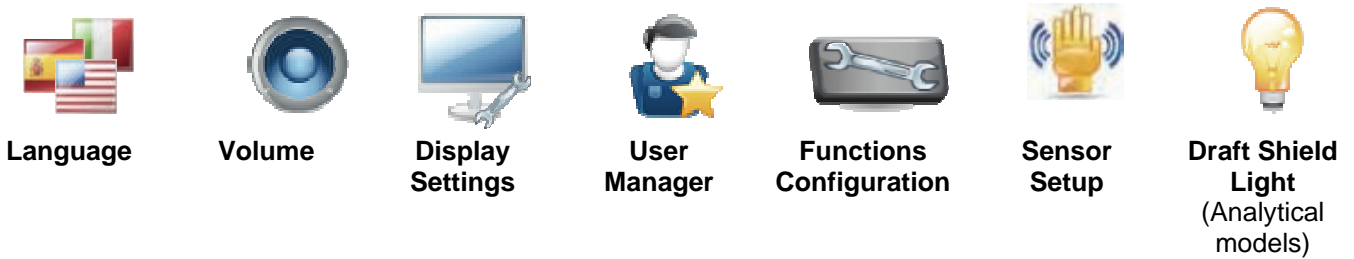
The display shows status, followed by the difference between the current calibration weight and the stored calibration data.

After 3 seconds, the display returns to the current application.

5.4 User Settings

When using the Balance for the first time, enter this sub-menu to set User-defined values like **Language**, **Display Settings**, **Volume**, **Functions Configuration** and the **Touchless Sensor** setup.

5.4.1 User Settings Sub-menu



Factory default settings are shown below in bold.

5.4.2 Language

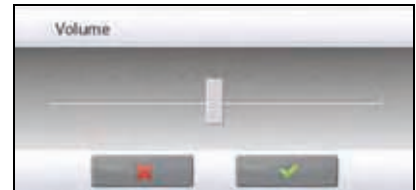
Set the language displayed for menus and displayed messages.

- English** (default)
- German
- French
- Spanish
- Italian



5.4.3 Volume

Controls the built-in Speaker loudness.
 Default value= **5** (mid-level)
 0= disabled (Off)
 Range is 0 to 10



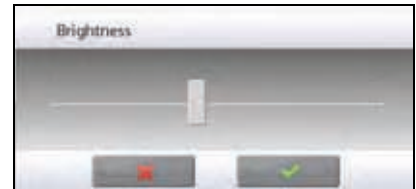
5.4.4 Display Settings

Use this sub-menu to change the setting for:
Screen Brightness: Default value= **50** (mid-level)
 Range is 20 to 100

Touch Calibrate

"Touch the screen at the center of the ring. **O** Press here."
 (First top-left, then bottom-right.)

Auto Dim (Dims the display if no Screen Activity for x minutes)
 Default value = **OFF** (disabled). Range is 1 to 240 minutes



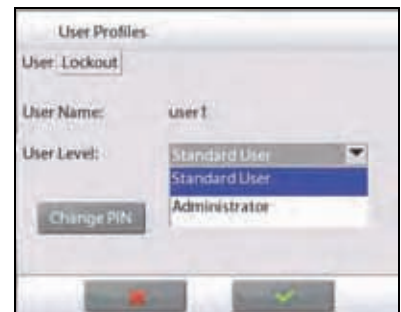
5.4.5 User Manager

Enter this sub-menu to create user profiles if desired.

User Level: Default is Standard User; Administrator is available.

Change PIN: Set password if desired.

Lockout: Can be used by Administrator to lockout the Menu items of a named User.



5.4.6 Functions Configuration

Touch **Functions Configuration** to see a table of Selected and Available functions. Press > to move a function from **Available** to **Selected**, and press < to move them back.

To move all functions to the right, Press >> and press << to move them back.



5.4.7 TouchLess Sensor Setup

If desired, assign **Print**, **Zero**, **Tare**, or **Calibrate** to the Touchless Sensors **Terminal Right**, **Terminal Left**, **Base Right**, and **Base Left**.



5.4.8 Draft Shield light

Set the status of the lighted Draft Shield feature.

OFF = disabled.

ON = enabled.



5.5 Balance Setup

Enter this sub-menu to customize Balance display functionality.

5.5.1 Balance Set-up sub-menu



Factory default settings are shown below in bold.



5.5.2 Stable Range

Set the amount the reading can vary while the stability symbol remains on.

0.5 D	= 0.5 graduations
1 D	= 1 graduation
2 D	= 2 graduations
3 D	= 3 graduations
5 D	= 5 graduations

Note: When LEGAL FOR TRADE (below) is set to ON, the setting is forced to 1 D. The setting is locked when the Security Switch is set to the ON position.



5.5.3 Filter level

Set the amount of signal filtering.

LOW	= faster stabilization time with less stability.
MEDIUM	= normal stabilization time with normal stability.
HIGH	= slower stabilization time with more stability.



5.5.4 Auto Zero Tracking

Set the automatic zero tracking functionality.

OFF	= disabled.
0.5 D	= display maintains zero up to a drift of 0.5 graduation per second
1 D	= display maintains zero up to a drift of 1 graduation per second.
3 D	= display maintains zero up to a drift of 3 graduations per second.

Note: When Legal for Trade is set to ON, the AZT setting is forced to 0.5 D. The OFF setting is still available. The setting is locked at the current setting when the security switch is set to the ON position



5.5.5 Auto Tare

Set the automatic Tare.

OFF = disabled.
ON = enabled.



5.5.6 Gross Indicator

Set the symbol displayed for gross weights.

OFF = no symbol is displayed.
GROSS = the G symbol is displayed.
BRUTTO = the B symbol is displayed.



5.5.7 Legal For Trade

Use this menu to set the Legal for Trade status.

OFF = standard operation.
ON = operation complies with Weights and Measures regulations.

Note: When Legal for Trade is set to ON, the menu settings are affected as follows:

Calibration Menu:

AutoCal internal Calibration is forced to ON and hidden. Automatic Calibration, and Calibration Test functions are available. All other functions are hidden.

Balance Setup Menu:

Stability Indicator Range is locked at 1 Division.
 Auto Zero Tracking is limited to 0.5 Division and OFF.
 Auto Tare and Gross Indicator are locked at their current setting.
 Graduations is forced to 1 Division and the menu item is hidden.
 Weighing Units menu: all units are locked at their current settings.

Communication Menu:

Stable Weight Only is locked ON.
 Numeric Value Only is locked OFF.
 Auto print mode selections are limited to OFF, On Stability, and Interval.
 Continuous is not available.

Note: The security switch under the Base must be in the locked position to set Legal for Trade to ON. The security switch must be in the unlocked position to set Legal for Trade to OFF. See Section 6.

5.5.8 Graduations

Set the displayed readability of the balance.

1 Division = standard readability.
10 Divisions = readability is increased by a factor of 10.

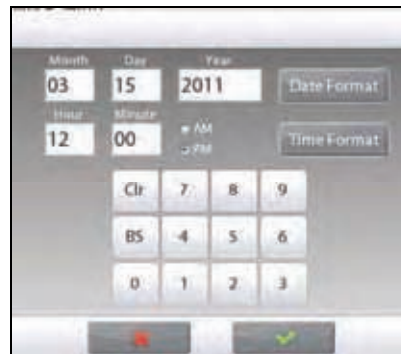
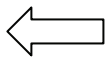
For example, if the standard readability is 0.01g, selecting 10 Divisions will result in a displayed reading of 0.1g.

5.5.9 Date & Time

Set the current Date and Time.

Change the format (if desired), then enter the current value.

Select ✓ to return to the sub-menu.

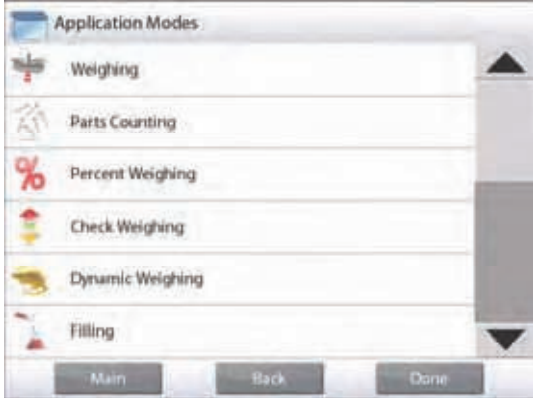


5.6 Applications

Enter this sub-menu to activate the desired Balance Applications. Only one application can be running at a time.

(The use of each Application is described in detail in Section 4.)

5.6.1 Turning an Application ON/OFF



Touch line of the desired application. In the Item option screen, touch the **Enabled** line to toggle it on or off.

Once an Application is enabled (turned on) it may be chosen from the **Applications** shortcut (top-left of all home screens).



The current menu item status is shown: OFF = disabled, **ON** = enabled

5.7 Weighing Units

Enter this sub-menu to activate the desired units of measure.

Note: Due to national laws, the indicator may not include some of the units of measure listed.

5.7.1 Units Sub-menu

mg milligram	g gram	kg kilogram	ct carat	oz ounce	ozt ounce troy
lb pound	dwt pennyweight	Grain grain	N Newton	mom momme	msg mesgal
HKt Tael (HK)	SGt Tael (SG)	TWt Tael (TW)	tical tical	tola tola	bht baht
C1 Custom Unit 1	C2 Custom Unit 2	C3 Custom Unit 3			

Note: If **LEGAL FOR TRADE** is set to **ON**, the Unit menu is locked.

5.7.2 Turning a Unit ON/OFF

Select the desired unit, then touch the item to toggle it either on or off.

The current menu item status is shown.

OFF = disabled

ON = enabled



5.7.3 Custom Units

Use each Custom Unit to display weight in an alternative unit of measure. The custom unit is defined using a conversion factor, where the conversion factor is the number of custom units per kilogram expressed in scientific notation (Factor $\times 10^{\text{Exponent}}$).

For example: To display weight in troy ounces (32.15075 troy ounces per kilogram) enter a Factor of 0.321508 and an Exponent of 2.

Set the status.

OFF = disabled

ON = enabled

When Custom Unit is set to ON, the Factor, Exponent and Least Significant Digit must be set.

Factor

Set the conversion factor using the numeric keypad.

Settings of 0.00001 to 1.9999999 are available. The default setting is **1.000000**

Exponent

Set the factor multiplier.

0 = multiply the Factor by 1 (1×10^0)
 1 = multiply the Factor by 10 (1×10^1)
 2 = multiply the Factor by 100 (1×10^2)
 3 = multiply the Factor by 1000 (1×10^3)

-3 = divide the Factor by 1000 (1×10^{-3})
 -2 = divide the Factor by 100 (1×10^{-2})
 -1 = divide the Factor by 10 (1×10^{-1})

Least Significant Digit

Set the graduation.

Settings of 0.00001, 0.00002, 0.00005, 0.0001, 0.0002, 0.0005, **0.001**, 0.002, 0.005, 0.01, 0.02, 0.05, 0.1, 0.2, 0.5, 1, 2, 5, 10, 20, 50, 100, 200, 500 and 1000 are available.

Note: Least Significant Digit setting selections are dependent on the Factor and Exponent settings. Selections are limited.

5.8 GLP and GMP Data

Enter this menu to set the Good laboratory Practices (GLP) data.

5.8.1 GLP Data Sub-menu



5.8.2 Header

Enables the printing of GLP headings. There are up to 5 headings available.

Alphanumeric settings up to 25 characters are available for each Header setting. .



5.8.3 Balance Name

Set the balance identification.

Alphanumeric settings up to 25 characters are available. The default setting is **blank**.



5.8.4 User Name

Set the user identification.

Alphanumeric settings up to 25 characters are available. The default setting is **blank**.



5.8.5 Project Name

Enter this menu to set the Project identification.

Alphanumeric settings up to 25 characters are available. The default setting is **blank**.

5.9 Communication

Enter this menu to define external communication methods and to set printing parameters.

Data may be output to either a printer or PC (See Section 5.9.8 for output samples.)

Factory default settings are shown in bold.

Note: The COM3 menu is only available if the optional Interface is installed.

5.9.1 Communication Sub-menu



**RS232
Standard**

USB

Choosing an item brings up another menu level (*RS232 shown*):



Device Settings

Print Settings

Choosing a Settings item brings up yet another menu level; the device settings are dependent on the COM chosen (*RS232 shown*)

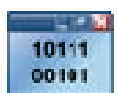
Device Settings Menu: (*RS232 shown*)



5.9.2 Baud Rate

Set the baud rate (bits per second).

2400	= 2400 bps
4800	= 4800 bps
9600	= 9600 bps
19200	= 19200 bps
38400	= 38400 bps



5.9.3 Transmission

Set the data bits, stop bit, and parity.

7 EVEN 1	= 7 data bits, even parity
7 ODD 1	= 7 data bits, odd parity
7 NONE 1	= 7 data bits, no parity
8 NONE 1	= 8 data bits, no parity
7 EVEN 2	= 7 data bits, even parity
7 ODD 2	= 7 data bits, odd parity
7 NONE 2	= 7 data bits, no parity
8 NONE 2	= 8 data bits, no parity



5.9.4 Handshake

Set the flow control method.

NONE	= no handshaking
XON-XOFF	= XON/XOFF handshaking
HARDWARE	= hardware handshaking (COM1 menu only)



5.9.5 Alternate Command

Enter this sub-menu to set a different command character for the P (Print), T (Tare) or Z (Zero) commands.

Note: The selected character can only be used for one command.

Alternate Print Command

Set the alternate command character for Print.

Settings of A to Z are available. The default setting is **P**.

Alternate Tare Command

Set the alternate command character for Tare.

Settings of A to Z are available. The default setting is **T**.

Alternate Zero Command

Set the alternate command character for Zero.

Settings of A to Z are available. The default setting is **Z**.

Print Settings Menu:

Note: If LEGAL FOR TRADE is set to ON, the print Output-Stable setting is not reset.



5.9.6 Print Output

Print Stable Weight Only

Set the printing criteria.

OFF	= values are printed immediately, regardless of stability.
ON	= values are printed only when the stability criteria are met.

Print Numeric Value Only

Set the printing criteria.

OFF	= All data values are printed
ON	= Only numeric data values are printed



5.9.7 Auto Print

Set the automatic printing functionality.

- OFF** = disabled
- ON STABLE** = printing occurs each time the stability criteria are met.
- INTERVAL** = printing occurs at the defined time interval.
- CONTINUOUS** = printing occurs continuously.

When ON STABLE is selected, set the conditions for printing.

- LOAD** = Prints when the displayed load is stable.
- LOAD ZERO** = Prints when the displayed load or zero reading is stable.

When INTERVAL is selected, set the time interval using the numeric keypad.

Settings of 1 to 3600 seconds are available.



5.9.8 Print Calibration Data

Set the automatic Calibration Data printing functionality.

- OFF** = disabled
- ON** = enabled



5.9.9 Print Content

Enter this sub-menu to define the content of the printed data.

See details below:

Header

Set the status.

- OFF** = the user defined header is not printed.
- ON** = the user defined header is printed.

```

USER DEFINED TEXT
USER DEFINED TEXT
USER DEFINED TEXT
USER DEFINED TEXT
USER DEFINED TEXT
  
```

NOTE: The header information must be defined using the H x "text" interface command. (See Section 5.1.)

Date and Time

Set the status.

- OFF** = the time and date are not printed.
- ON** = the time and date are printed.

```

01/31/10  12:30 PM
  
```

Balance ID

Set the status.

- OFF** = the Balance ID value is not printed.
- ON** = the Balance ID value is printed.

```

Balance Id:
XXXXXXXXXXXX
  
```

Balance Name

Set the status.

- OFF** = the Balance Name is not printed.
- ON** = the Balance Name is printed.

```

Balance Name:
XXXXXXXXXXXX
  
```

User Name

Set the status.

- OFF** = the User Name is not printed.
- ON** = the User Name is printed.

```

User Name:  XXXXXXXXXXXX
  
```

Project Name

Set the status.

- OFF** = the Project Name is not printed.
- ON** = the Project Name is printed.

```

Project Name: XXXXXXXXXXXX
  
```

Application Name

Set the status.

- OFF** = the Application Name is not printed.
- ON** = the Application Name is printed.

```

Application Name: XXXXXXXXXXXX
  
```

Result

Set the status.

- OFF** = the displayed reading is not printed.
- ON** = the displayed reading is printed.

NUMERIC ONLY = only the numeric portion of the displayed reading is printed.

Gross

Set the status.

- OFF** = the gross weight is not printed.
- ON** = the gross weight is printed.

```

12.000 kg
  
```

Net

Set the status.

- OFF** = the net weight is not printed.
- ON** = the net weight is printed.

```

10.000 kg NET
  
```

Tare

Set the status.

- OFF** = the tare weight is not printed.
- ON** = the tare weight is printed.

Information

Set the status.

- OFF** = the reference info is not printed.
- ON** = the reference info is printed.

Note: See below for more clarification

Signature Line

Set the status.

- OFF** = the Signature Line is not printed.
- ON** = the Signature Line is printed.

```

Signature: _____
  
```


NOTE: The Information is dependent on the application and the ACCUMULATE setting. Examples are shown below.

Mode	Accumulate set OFF	Accumulate set ON
Weighing	None	N: 10 Total: 10.000 kg Avg: 1.000 kg Std: 0.001 kg Min: 0.999 kg Max: 1.001 kg Diff: 0.002 kg
Counting	APW: 0.100 kg	APW: 0.100 kg N: 10 Total: 1000 Pcs Avg: 100 Pcs Std: 1 Pcs Min: 99 Pcs Max: 101 Pcs Diff: 2 Pcs
Percent	Ref Wt: 1.23 kg	Ref Wt: 1.23 kg
Check Weighing	Under: 0.995 kg Over: 1.005 kg	Under: 0.995 kg Over: 1.005 kg N: 10 Total: 10.000 kg Avg: 1.000 kg Std: 0.001 kg Min: 0.999 kg Max: 1.001 kg Diff: 0.002 kg
Dynamic	Level: 0	Level: 0 N: 10 Total: 10.000 kg Avg: 1.000 kg Std: 0.001 kg Min: 0.999 kg Max: 1.001 kg Diff: 0.002 kg



5.9.10 Print Layout

This sub-menu is used to define the format of the data output to a printer or computer.

Format

Set the printing format.

- MULTI** = a multiple line printout is generated. A CRLF is added after each data output.
- SINGLE** = a single line printout is generated. A TAB delimiter is added between each data output.

Feed

Set the paper feed.

- NONE** = the paper remains in its current position after printing.
- LINE** = move the paper up one line after printing.
- 4 LINE** = move the paper up four lines after printing.
- FORM** = a form feed is appended to the output.



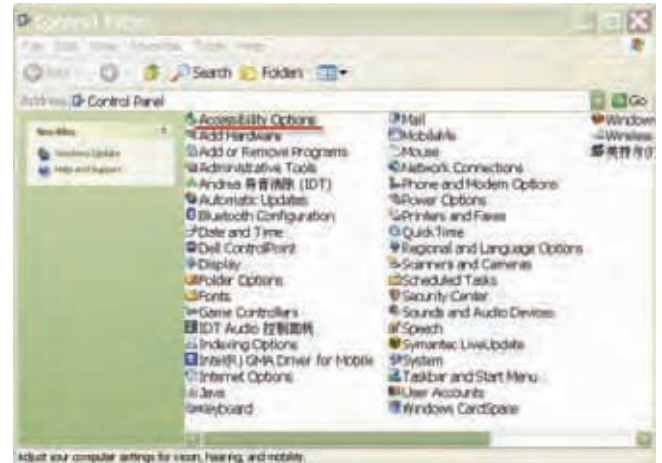
5.9.11 Data Transfer Function

Output weighing results directly to a PC application. Setup is easy and no additional software is required.

- OFF** = do not print.
- ON** = print the specified settings.

Click the Start Menu in Windows XP system and click "Settings" → open **Control Panel**.

Double click **Accessibility Options** in Control Panel.



Select the **General** tab in Accessibility Options.



Check **Use Serial Keys**, and click the **Settings** button.



Select the **Serial Port**, and set the **Baud rate** to **9600**.

After selecting, click **OK** to close setting for serial keys.

Close the Control Panel.

Run Excel to open one blank sheet. Focus the cursor on one item.

At this time, if scale sends data to the PC through the RS232 port, the data will be put into the cell, and the cursor will automatically move to the next vertical cell.

Note: If the weighing value is a negative number, set the target cell in TEXT format. Otherwise, Excel will not distinguish it as a negative number.



5.10 Library

When an item is processed on a regular basis, the item's data may be stored in memory for future use. This memory is referred to as the Balance's Library.

Refer to Section 4 for details.

5.11 I/O Settings

Enter this menu to set the optional input and output device parameters.

Set the function to be controlled by an optional external input device, such as a footswitch. There are four possible settings for each.

OFF	= disabled
ZERO	= equivalent to pressing the ZERO button.
TARE	= equivalent to pressing the TARE button.
PRINT	= equivalent to pressing the PRINT button.

5.12 Diagnostics

Use this menu to enable the Diagnostics (troubleshooting) functions, and to enter the Service menu;



5.12.1 Level Bubble Light

To verify proper operation of the illuminated Level Bubble.

When selected, this light should blink.



5.12.2 Draft Shield Light (Analytical models)

To verify proper operation of the Draft Shield Light.

When selected, this light should blink.



5.12.3 Sensors

To verify proper operation of each Touchless Sensor.

When operated, each sensor should light and make a sound.



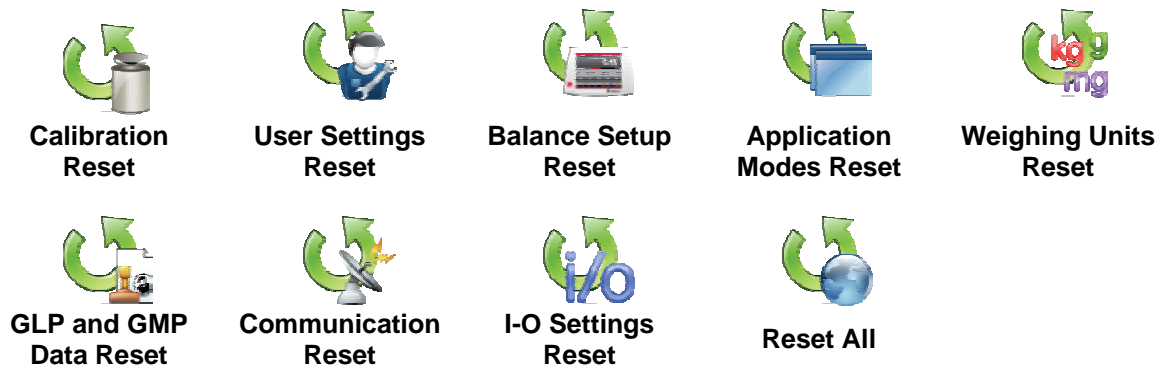
5.12.4 Service Menu

Used to enter the Ohaus Service menu (Service personnel only). A password is required to access this menu;

5.13 Factory Reset

Use this sub-menu to reset the menus to their Factory default settings.

5.13.1 Factory Reset Sub-menu



5.13.2 Reset Calibration

Select **YES** to return all Calibration menu items to their factory settings.

5.13.3 Reset User Settings

Select **YES** to return all User Settings menu items to their factory settings.

5.13.4 Reset Balance Setup

Select **YES** to return all Balance Setup menu items to their factory settings.

5.13.5 Reset Application Modes

Select **YES** to return all Application Modes menu items to their factory settings.

5.13.6 Reset Weighing Units

Select **YES** to return all Weighing Units menu items to their factory settings.

5.13.7 Reset GLP and GMP Data

Select **YES** to return all GLP and GMP Data menu items to their factory settings.

5.13.8 Reset Communication

Select **YES** to return all Communication menu items to their factory settings.

5.13.9 Reset I/O Settings

Select **YES** to return all I/O Settings menu items to their factory settings.

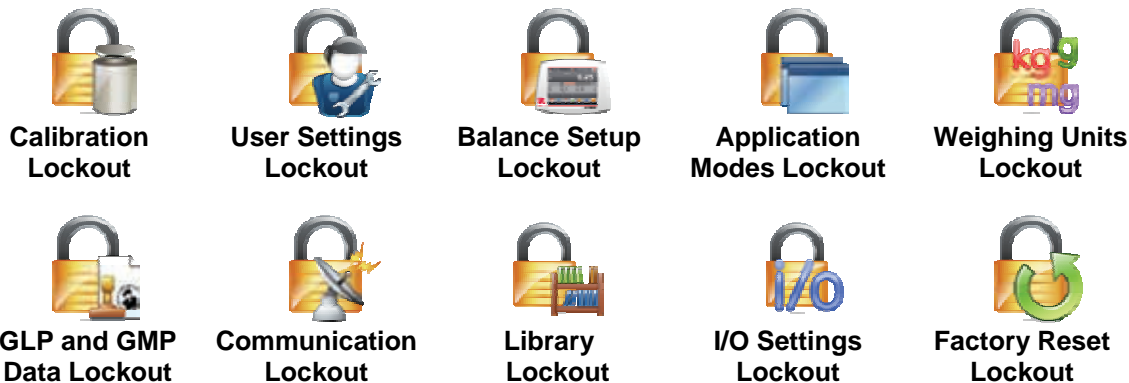
5.13.10 Reset All (Global Reset)

Select **YES** to return all the menu items to their factory settings.

5.14 Lockout

Use this menu to prevent unauthorized changes to menu settings. When the menu is locked and the security switch is set to ON, the locked menus can be viewed but not changed. Factory default settings are shown in bold.

5.14.1 Lockout Sub-menu



5.14.2 Lock Calibration

Set the status.

- OFF** = the Calibration menu is not locked.
- ON** = the Calibration menu is locked.

5.14.3 Lock User Settings

Set the status.

- OFF** = the User Settings menu is not locked.
- ON** = the User Settings menu is locked.

5.14.4 Lock Balance Setup

Set the status.

- OFF** = the Balance Setup menu is not locked.
- ON** = the Balance Setup menu is locked.

5.14.5 Lock Application Modes

Set the status.

- OFF** = the Applications menu is not locked.
- ON** = the Applications menu is locked.

5.14.6 Lock Weighing Units

Set the status.

- OFF** = the Units menu is not locked.
- ON** = the Units menu is locked.

5.14.7 Lock GLP and GMP Data

Set the status.

- OFF** = the GLP and GMP Data menu is not locked.
- ON** = the GLP and GMP Data menu is locked.

5.14.8 Lock Communication

Set the status.

- OFF = the Communication menu is not locked.
- ON = the Communication menu is locked.

5.14.9 Lock Library

Set the status.

- OFF = the Library menu is not locked.
- ON = the Library menu is locked.

5.14.10 Lock I/O Settings

Set the status.

- OFF = the I/O Settings menu is not locked.
- ON = the I/O Settings menu is locked.

5.14.11 Factory Reset

Set the status.

- OFF = the Factory Reset menu is not locked.
- ON = the Factory Reset menu is locked.

5.15 Securing the Menu and Key Lock menu settings

A slide switch is used to secure the Lock menu settings. When the switch is set to the ON position, the Lock menu settings may be viewed but not changed. This switch is located under the Base.

Set the position of the switch to ON by sliding the external Lock Switch to LOCKED as shown in Section 6.

When the switch is in the ON position, the start up display includes the LOCK ON message.

Note: This switch is also used in conjunction with the Legal for Trade menu item. When the Legal for Trade menu is set to ON, the switch must be set to the ON position to prevent calibration and changes to metrologically significant settings. Refer to Section 6 for more information.

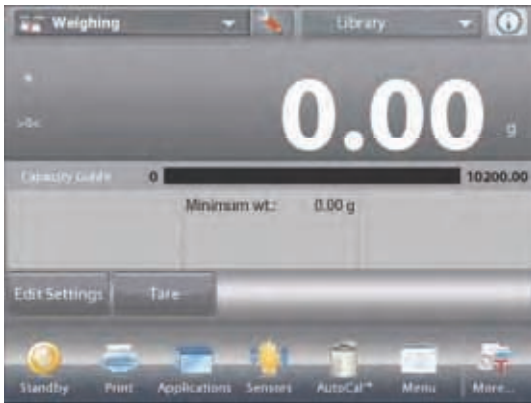


5.16 Information

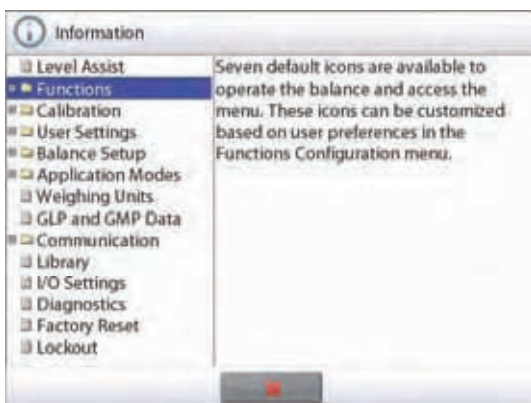
Information is available from any application as well as from the Main Menu. A brief description of the item selected is displayed.

This feature is menu based.

5.16.1 Using Information



- Touch the Info Icon to bring up the menu (UPPER RIGHT)



- Information topics, beginning with Level Assist
- Touch the word or the “+” in front of it, to open a topic.
- Touch **X** to close the Information topic.

6. LEGAL FOR TRADE

When the balance is used in trade or a legally controlled application it must be set up, verified and sealed in accordance with local weights and measures regulations. It is the responsibility of the purchaser to ensure that all pertinent legal requirements are met.

6.1 Settings

Before verification and sealing, perform the following steps in Order:

1. Verify that the menu settings meet the local weights and measures regulations.
2. Units menu should be reviewed. Verify the units turned **On** meet the local weights and measures regulations.
3. Perform a calibration as explained in Section 5.
3. Set the position of the Security Switch to the locked position.
4. Set Legal for Trade to ON in the Balance Setup menu.

6.2 Verification

A weights and measures official or authorized service agent must perform the verification procedure.

6.3 Sealing

After the Balance has been verified, it must be sealed to prevent undetected access to the legally controlled settings. Before sealing the device, ensure that the security switch is in the Locked position and the Legal for Trade setting in the Balance Setup menu has been set to ON.

If using a wire seal, pass the sealing wire through the holes in the security switch and Bottom Housing as shown.

If using a paper seal, place the seal over the security switch and Bottom Housing as shown.



Un-Locked



Locked with Wire Seal



Locked with Paper Seal

7. PRINTING

7.1 Connecting, Configuring and Testing the Printer/Computer Interface

Use the built-in RS-232 Port to connect either to a computer or a printer.
If connecting to a computer, use HyperTerminal or similar software.
(Find HyperTerminal under **Accessories/Communications** in Windows XP.)

Connect to the computer with a standard (straight-through) serial cable.

Choose **New Connection**, “connect using” COM1 (or available COM port).

Select **Baud=9600; Parity=8 None; Stop=1; Handshaking=None**. Click OK.

Choose Properties/Settings, then ASCII Setup. Check boxes as illustrated:
(**S**end line ends...; **E**cho typed characters...; **W**rap lines...)

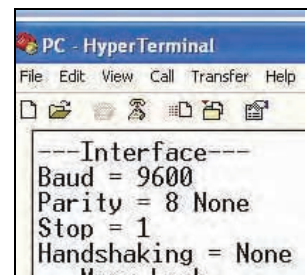
Use RS232 Interface Commands (Section 9.6.1) to control the balance from a PC.

Note: When the HyperTerminal configuration is complete, it will automatically print the results of a **Cal Test** operation, and echo print commands sent to the scale.

Printer Connection

Two printers compatible with Explorer Balances are available from Ohaus.
(See Section 9.) Connect a straight-through serial cable to the scale’s RS232 port,
or connect using the scale’s USB port.

See sample Print Output Formats below.



7.2 Printout Examples

Examples for each Application are shown with all items turned **ON** in the **Print Content** menu. The default values for **Header** lines 1-5 are also shown.

Weighing
Company Name
Address 1
Address 2
Address 3
Address 4
12/7/2010 3:00 PM
Balance ID:
Balance Name: EXPLORER
User Name:
Project Name:
Application: Weighing
Result: 2.771 g Net
Gross: 4.148 g
Net: 2.771 g Net
Tare: 1.377 g T
Minimum Weight: 0.000 g
Signature: _____

Weighing->Statistics
Company Name
Address 1
Address 2
Address 3
Address 4
12/7/2010 3:04 PM
Balance ID:
Balance Name: EXPLORER
User Name:
Project Name:
Statistics
Number of Samples: 3
Total: 2.737 g
Average: 0.912 g
Standard Deviation: 0.372 g
Minimum: 0.457 g
Maximum: 1.369 g
Difference: 0.912 g
Signature: _____

Parts Counting->Standard
Company Name
Address 1
Address 2
Address 3
Address 4
12/7/2010 3:20 PM
Balance ID:
Balance Name: EXPLORER
User Name:
Project Name:
Application: Parts Counting
Quantity: 3 PCS Net
Gross: 2.325 g
Net: 1.379 g Net
Tare: 0.946 g T
APW: 0.4551 g
Samples: 1 PCS
Signature: _____

Parts Counting->Check
Company Name
Address 1
Address 2
Address 3
Address 4
12/7/2010 3:21 PM
Balance ID:
Balance Name: EXPLORER
User Name:
Project Name:
Application: Check Counting
Quantity: 3 PCS Net
Status: Under
Gross: 2.323 g
Net: 1.377 g Net
Tare: 0.946 g T
APW: 0.4551 g
Samples: 1 PCS
Over Limit: 30 PCS
Under Limit: 10 PCS
Signature: _____

Parts Counting->Fill

Company Name
Address 1
Address 2
Address 3
Address 4
12/7/2010 3:23 PM
Balance ID:
Balance Name: EXPLORER
User Name:
Project Name:
Application: Fill Counting
Quantity: 3 PCS Net
Gross: 2.324 g
Net: 1.378 g Net
Tare: 0.946 g T
APW: 0.4551 g
Samples: 1 PCS
Target: 4 PCS
Difference: -1 PCS
Signature:_____

Parts Counting->Statistics

Company Name
Address 1
Address 2
Address 3
Address 4
12/7/2010 3:11 PM
Balance ID:
Balance Name: EXPLORER
User Name:
Project Name:
Statistics
Number of Samples: 3
Total: 6 PCS
Average: 2 PCS
Standard Deviation: 1 PCS
Minimum: 1 PCS
Maximum: 3 PCS
Difference: 2 PCS
Signature:_____

Percent Weighing

Company Name
Address 1
Address 2
Address 3
Address 4
12/7/2010 3:27 PM
Balance ID:
Balance Name: EXPLORER
User Name:
Project Name:
Application: Percent Weigh
Percentage: 91 % Net
Gross: 1.401 g
Net: 0.455 g Net
Tare: 0.946 g T
Reference: 0.500 g
Reference Adjust: 100 %
Difference: -0.045 g
Difference: -9.00 %
Signature:_____

Check Weigh->Over Under

Company Name
 Address 1
 Address 2
 Address 3
 Address 4
 12/7/2010 3:32 PM
 Balance ID:
 Balance Name: EXPLORER
 User Name:
 Project Name:
 Application: Check Weighing
 Result: Accept
 Gross: 1.401 g
 Net: 0.455 g Net
 Tare: 0.946 g T
 Over Limit: 619.999 g
 Under Limit: 0.010 g
 Signature:_____

Check Weigh-> Nom, Wt Tol

Company Name
 Address 1
 Address 2
 Address 3
 Address 4
 12/7/2010 3:34 PM
 Balance ID:
 Balance Name: EXPLORER
 User Name:
 Project Name:
 Application: Check Weighing
 Result: Under
 Gross: 1.401 g
 Net: 0.455 g Net
 Tare: 0.946 g T
 Target: 310.000 g
 + Tolerance (wt.): 155.000 g
 - Tolerance (wt.): 155.000 g
 Signature:_____

Check Weigh-> Nom, % Tol

Company Name
 Address 1
 Address 2
 Address 3
 Address 4
 12/7/2010 3:35 PM
 Balance ID:
 Balance Name: EXPLORER
 User Name:
 Project Name:
 Application: Check Weighing
 Result: Under
 Gross: 1.399 g
 Net: 0.453 g Net
 Tare: 0.946 g T
 Target: 310.000 g
 + Tolerance (%): 50.00 %
 - Tolerance (%): 50.00 %
 Signature:_____

Check Weighing ->Statistics

Company Name
 Address 1
 Address 2
 Address 3
 Address 4
 12/7/2010 3:37 PM
 Balance ID:
 Balance Name: EXPLORER
 User Name:
 Project Name:
 Statistics
 Number of Samples: 3
 Total: 2.725 g
 Average: 0.908 g
 Standard Deviation: 0.372 g
 Minimum: 0.453 g
 Maximum: 1.364 g
 Difference: 0.911 g
 Signature:_____

Dynamic Weighing
Company Name
Address 1
Address 2
Address 3
Address 4
12/7/2010 3:38 PM
Balance ID:
Balance Name: EXPLORER
User Name:
Project Name:
Application: Dynamic Weigh
Averaging Time: 10 seconds
Gross: 2.310 g
Net: 1.364 g Net
Tare: 0.946 g T
Final weight: 12.643 g
Signature: _____

Dynamic ->Statistics
Company Name
Address 1
Address 2
Address 3
Address 4
12/7/2010 3:41 PM
Balance ID:
Balance Name: EXPLORER
User Name:
Project Name:
Statistics
Number of Samples: 3
Total: 181.092 g
Average: 60.364 g
Standard Deviation: 40.027 g
Minimum: 31.404 g
Maximum: 116.966 g
Difference: 85.563 g
Signature: _____

Filling
Company Name
Address 1
Address 2
Address 3
Address 4
12/7/2010 3:42 PM
Balance ID:
Balance Name: EXPLORER
User Name:
Project Name:
Application: Filling
Result: 1.825 g Net
Gross: 2.771 g
Net: 1.825 g Net
Tare: 0.946 g T
Target: 10.000 g
Diff Weight g: -8.175 g
Diff Percent %: -81.8 %
Signature: _____

Filling->Statistics
Company Name
Address 1
Address 2
Address 3
Address 4
12/7/2010 3:44 PM
Balance ID:
Balance Name: EXPLORER
User Name:
Project Name:
Statistics
Number of Samples: 3
Total: 5.021 g
Average: 1.674 g
Standard Deviation: 0.435 g
Minimum: 1.366 g
Maximum: 2.289 g
Difference: 0.923 g
Signature: _____

Totalization

Company Name
 Address 1
 Address 2
 Address 3
 Address 4
 12/7/2010 3:46 PM
 Balance ID:
 Balance Name: EXPLORER
 User Name:
 Project Name:
 Application: Totalization
 Total: 5.939 g NET
 Gross: 2.778 g
 Net: 1.832 g Net
 Tare: 0.946 g T
 Samples: 4
 Average: 1.485 g
 Standard Deviation: 0.382 g
 Minimum: 0.911 g
 Maximum: 1.832 g
 Range: 0.921 g
 Signature: _____

Formulation->Recipe

Company Name
 Address 1
 Address 2
 Address 3
 Address 4
 12/7/2010 3:54 PM
 Balance ID:
 Balance Name: EXPLORER
 User Name:
 Project Name: AURORA
 Application: Formulation
 Total Target: 3.000 g
 Total Actual: 5.401 g
 Total Diff(%): 80.0 %
 Item 3
 Target: 1.000 g
 Actual: 1.345 g
 Diff(%): 34.5 %
 Item 2
 Target: 1.000 g
 Actual: 1.800 g
 Diff(%): 80.0 %
 Item 1
 Target: 1.000 g
 Actual: 2.256 g
 Diff(%): 125.6 %
 Signature: _____

Formulation->Free Formulat

Company Name
 Address 1
 Address 2
 Address 3
 Address 4
 12/7/2010 3:50 PM
 Balance ID:
 Balance Name: EXPLORER
 User Name: xiao
 Project Name: AURORA
 Application: Formulation
 Result: 1.345 g Net
 Gross: 2.291 g
 Net: 1.345 g Net
 Tare: 0.946 g T
 Item 1: 1.833 g
 Item 2: 0.888 g
 Item 3: 1.344 g
 Total: 4.065 g
 Signature: _____

Differential

Company Name
Address 1
Address 2
Address 3
Address 4
12/7/2010 3:57 PM
Balance ID:
Balance Name: EXPLORER
User Name:
Project Name:
Application: Differential
Result: 1.341 g Net
Gross: 2.287 g
Net: 1.341 g Net
Tare: 0.946 g T
Item Name: Item 3
Initial wt.: 1.338 g
Final wt.: 1.343 g
Difference: -0.005 g
Difference: -0.4 %
Signature: _____

Peak Hold

Company Name
Address 1
Address 2
Address 3
Address 4
12/7/2010 4:00 PM
Balance ID:
Balance Name: EXPLORER
User Name:
Project Name:
Application: Peak Hold
Peak weight: 115.722 g
Gross: 0.921 g
Net: -0.025 g Net
Tare: 0.946 g T
On Stability: No
Signature: _____

Density Determination

Company Name
Address 1
Address 2
Address 3
Address 4
12/7/2010 4:01 PM
Balance ID:
Balance Name: EXPLORER
User Name:
Project Name:
Application: Density (Solid)
Density Determ: 1.9668 g/cc
Gross: 1.832 g
Net: 0.886 g Net
Tare: 0.946 g T
Weight in air: 1.799 g
Weight in liquid: 0.886 g
Auxiliary liquid: Water
Water Temp.: 20.0 C
Porous Material: Off
Signature: _____

Pipette Adjustment

Company Name
Address 1
Address 2
Address 3
Address 4
12/7/2010 4:04 PM
Balance ID:
Balance Name: EXPLORER
User Name:
Project Name:
Application: Pipette Adjust
Result: Fail
Nominal Volume: 2 ml
Inaccuracy: 77.12 %
Imprecision: 0.68 %
Water Temp.: 20.0 C
Barometric Unit: 1.0 ATM
Pipette Name:
Pipette Number:
Number of Samples: 4
> +2S: 0.00 %, 0
> +1S: 25.00 %, 1
+1S > Mean > -1S: 75.0 %, 3
< -1S: 0.00 %, 0
< -2S: 0.00 %, 0
Signature: _____

Ingredient Costing

Company Name
Address 1
Address 2
Address 3
Address 4
12/7/2010 4:09 PM
Balance ID:
Balance Name: EXPLORER
User Name:
Project Name:
Application: Ingredient Cost
Total Items: 4
Total Weight: 4.570 g
Total Cost: 13.73 \$
Item 1
Item Weight: 0.454 g
Unit Cost: 1.00 \$/g
Item's Total Cost: 0.45 \$
Item 2
Item Weight: 0.910 g
Unit Cost: 2.00 \$/g
Item's Total Cost: 1.82 \$
Signature: _____

SQC

Company Name
Address 1
Address 2
Address 3
Address 4
12/7/2010 4:14 PM
Balance ID:
Balance Name: EXPLORER
User Name:
Project Name:
Application: SQC
Batch Name: x
Samples: 4
Unit : g
Nominal Weight: 310.000 g
Average: 1.141 g
Maximum: 1.834 g
Minimum: 0.454 g
Standard Deviation: 0.514 g
Relative Deviation: 0.451 g
Range: 1.380 g
> +T2: 0.00 %, 0
> +T1: 0.00 %, 0
+T1 > N > -T1: 0.00 %, 0
< -T1: 0.00 %, 0
< -T2: 100.00 %, 4
Signature:_____

Span Calibration and User Calibration:

Content
HEADER 1
HEADER 2
HEADER 3
HEADER 4
HEADER 5
TIME
RESULT
RESULT
RESULT
RESULT
RESULT

Span Calibration
Company Name
Address 1
Address 2
Address 3
Address 4
12/6/2010 4:33 AM
---Span Calibration---
Balance ID:
Balance Name: EXPLORER
User Name:
Project Name:
New Calibration: 1999.99 g
Old Calibration: 2000.00 g
Difference: 0.01 g
Weight ID_____
Signature:_____
-----End-----

User Calibration
Company Name
Address 1
Address 2
Address 3
Address 4
12/6/2010 4:36 AM
---User Calibration---
Balance ID:
Balance Name: EXPLORER
User Name:
Project Name:
New Calibration: 1999.99 g
Old Calibration: 2000.00 g
Difference: 0.01 g
Weight ID_____
Signature:_____
-----End-----

The **CAL TEST** printout is automatically printed when a Calibration Test is performed.

Content
HEADER 1
HEADER 2
HEADER 3
HEADER 4
HEADER 5
TIME
RESULT
RESULT
RESULT
RESULT
RESULT

Calibration Test
Company Name
Address 1
Address 2
Address 3
Address 4
12/6/2010 4:33 AM
---Calibration test---
New Calibration: 3999.97 g
Old Calibration: 4000.00 g
Difference: 0.03 g
Weight ID_____
-----End-----

7.3 Output Format

The Result Data, and G/N/T data, is output in the following format.

Field:	Label ¹	Space ²	Weight ³	Space ²	Unit ⁴	Space	Stability ⁵	Space	G/N ⁶	Space	Term. Characters ⁷
Length:		1	11	1		1	≤ 1	≤ 1	≤ 3	0	≤ 8

1. In certain cases, a Label field of up to 11 characters is included.
2. Each field is followed by a single delimiting space (ASCII 32).
3. The Weight field is 9 right justified characters. If the value is negative, the “-” character is located at the immediate left of the most significant digit.
4. The Unit field contains the unit of measure abbreviation up to 5 characters.
5. The Stability field contains the “?” character if the weight reading is not stable. The Stability field and the following Space field are omitted if the weight reading is stable.
6. The G/N field contains the net or gross indication. For net weights, the field contains “NET”. For gross weights, the field contains nothing, “G” or “B”, depending on the GROSS INDICATOR menu setting.
7. The Termination Characters field contains CRLF, Four CRLF or Form Feed (ASCII 12), depending on the LINE FEED menu setting.

8. MAINTENANCE

8.1 Calibration

Periodically verify calibration by placing an accurate weight on the balance and viewing the result. If calibration is required, perform a Balance internal calibration.

8.2 Cleaning



Disconnect the Explorer Balance from the power supply before cleaning. Make sure that no liquid enters the interior of the Terminal or Base.

Clean the Balance at regular intervals.

Housing surfaces may be cleaned with a lint-free cloth slightly dampened with water or a mild cleaning agent.

Glass surfaces may be cleaned with a commercial glass cleaner.

Do not use solvents, harsh chemicals, ammonia or abrasive cleaning agents.

8.3 Troubleshooting

TABLE 8-1. TROUBLESHOOTING

Symptom / Display	Possible Cause	Remedy
Balance will not turn on	No power to Balance	Verify connection and voltage
Poor accuracy	Improper calibration Unstable environment	Perform calibration Move balance to suitable location
Cannot calibrate	Calibration Menu locked LFT set to on Unstable environment Incorrect calibration masses	Turn Calibration menu lock off Turn LFT off Move balance to suitable location Use correct calibration masses
Cannot change menu settings	Sub-menu locked LFT set to on	Unlock sub-menu Turn LFT off
Low Reference weight	Reference weight too small The weight on the pan is too small to define a valid reference weight.	Increase sample size
Invalid Piece Weight	Average piece weight is too small	Increase average piece weight
Operation Timeout	Weight reading is not stable	Move balance to suitable location
-----	Busy (tare, zero, printing)	Wait until completion

8.4 Service Information

If the troubleshooting section does not resolve your problem, contact an Authorized Ohaus Service Agent. For service assistance in the United States, call toll-free 1-800-526-0659 between 8:00 AM and 5:00 PM Eastern Standard Time. An Ohaus Product Service Specialist will be available to assist you. Outside the USA, please visit our website www.ohaus.com to locate the Ohaus office nearest you.

9. TECHNICAL DATA

9.1 Specifications

Ambient conditions

- Indoor use only
- Altitude: Up to 2000 m
- Specified Temperature range: 10°C to 30°C
- Humidity: maximum relative humidity 80 % for temperatures up to 31°C decreasing linearly to 50% relative humidity at 40°C
- Mains supply voltage fluctuations: up to $\pm 10\%$ of the nominal voltage
- Installation category II
- Pollution degree: 2
- Operability is assured at ambient temperatures between 5°C and 40°C

Materials

- Base Housing; die-cast Aluminum, Painted
- Top Housing, Base, Terminal: plastic (ABS)
- Weighing Platforms: 18/10 stainless steel
- In-use Cover, Terminal: plastic (PET)
- Draft Shield; Glass, plastic (ABS)

TABLE 9-1. SPECIFICATIONS

MODEL	EX124	EX224	EX324
Capacity	120 g	220 g	320 g
Readability d	0.1 mg		
Repeatability (std. dev.) (g)	0.0001 g		
Linearity (g)	± 0.0002 g		
Span Calibration Points (g)	50g, 100g	100g, 150g, 200g	150g, 200g, 300g
Weighing units	Baht, carat, grain, gram, milligram, mesgal, momme, Newton, ounce, pennyweight, Tael (Hong Kong), Tael, (Singapore), Tael (Taiwan), tical, tola, troy ounce, custom (3)		
Applications	Weighing, Parts Counting, Percent Weighing, Check Weighing, Dynamic Weighing, Filling, Totalization, Formulation, Differential Weighing, Peak Hold, Density Determination, Pipette Adjustment, Ingredient Costing, Statistical Quality Control		
Stabilization time (typical)	Within 2 seconds		Within 3 seconds
Display	Full-Color VGA Graphic LCD		
Display size	5.7 in / 14.5 cm (diagonal)		
Backlight	White LED		
Controls	4-wire resistive touch screen		
Communication	RS-232, USB		
Balance power input	12 VDC, 0.5A		
Power supply	AC Adapter Input: 100-240 VAC 0.6A 50-60 Hz AC Adapter Output: 12 VDC 1.5A		
Platform size (diameter)	90 mm 3.5 in		
Terminal Housing dimensions (W x D x H)	195 x 155 x 68 mm 7.7 x 6.1 x 2.7 inch		
Base Housing dimensions (W x D x H)	230 x 260 x 350 mm 9.1 x 10.2 x 13.8 inch		
Assembled dimensions (W x D x H)	230 x 393 x 350 mm 9.1 x 15.5 x 13.8 inch		
Net weight	6.9 kg 15.2 lb		
Shipping weight	9.7 kg 21.3 lb		

Note: Default Calibration weights shown in Bold

TABLE 9-2. SPECIFICATIONS (Cont.)

MODEL	EX223	EX423	EX623	EX1103
Capacity	220 g	420 g	620 g	1100 g
Readability d	0.001 g			
Repeatability (std. dev.)	0.001 g			
Linearity	± 0.002 g			
Span Calibration Points	100g, 150g, 200g	200g, 300g, 400g	300g, 400g, 500g , 600g	500g, 1000g
Weighing units	Baht, carat, grain, gram, milligram, mesgal, momme, Newton, ounce, pennyweight, pound, Tael (Hong Kong), Tael, (Singapore), Tael (Taiwan), tical, tola, troy ounce, custom (3)			
Applications	Weighing, Parts Counting, Percent Weighing, Check Weighing, Dynamic Weighing, Filling, Totalization, Formulation, Differential Weighing, Peak Hold, Density Determination, Pipette Adjustment, Ingredient Costing, Statistical Quality Control			
Stabilization time (typical)	Within 1.5 seconds			
Display	Full-Color VGA Graphic LCD			
Display size	5.7 in / 14.5 cm (diagonal)			
Backlight	White LED			
Controls	4-wire resistive touch screen			
Communication	RS-232, USB			
Balance power input	12 VDC, 0.5A			
Power supply	AC Adapter Input: 100-240 VAC 0.6A 50-60 Hz AC Adapter Output: 12 VDC 1.5A			
Platform size (diameter)	130 mm 5.1 in			
Terminal Housing dimensions (W x D x H)	195 x 155 x 68 mm 7.7 x 6.1 x 2.7 inch			
Base Housing dimensions (W x D x H)	230 x 260 x 350 mm 9.1 x 10.2 x 13.8 inch			
Assembled dimensions (W x D x H)	230 x 393 x 350 mm 9.1 x 15.5 x 13.8 inch			
Net weight	6.9 kg 15.2 lb			7.5 kg 16.5 lb
Shipping weight	9.7 kg 21.3 lb			10.3 kg 22.7 lb

Note: Default Calibration weights shown in Bold

TABLE 9-3. SPECIFICATIONS (Cont.)

MODEL	EX2202	EX4202	EX6202	EX10202
Capacity	2200 g	4200 g	6200 g	10200 g
Readability d	0.01 g			
Repeatability (std. dev.)	0.01 g			
Linearity	± 0.02 g			
Span Calibration Points	1000g, 2000g	2000g, 3000g, 4000g	3000g, 4000g, 5000g , 6000g	2500g, 5000g, 7500g, 10,000g
Weighing units	Baht, carat, grain, gram, kilogram, mesgal, momme, Newton, ounce, pennyweight, pound, Tael (Hong Kong), Tael, (Singapore), Tael (Taiwan), tical, tola, troy ounce, custom (3)			
Applications	Weighing, Parts Counting, Percent Weighing, Check Weighing, Dynamic Weighing, Filling, Totalization, Formulation, Differential Weighing, Peak Hold, Density Determination, Pipette Adjustment, Ingredient Costing, Statistical Quality Control			
Stabilization time (typical)	Within 1 second			
Display	Full-Color VGA Graphic LCD			
Display size	5.7 in / 14.5 cm (diagonal)			
Backlight	White LED			
Controls	4-wire resistive touch screen			
Communication	RS-232, USB			
Balance power input	12 VDC, 0.5A			
Power supply	AC Adapter Input: 100-240 VAC 0.6A 50-60 Hz AC Adapter Output: 12 VDC 1.5A			
Platform size	190 x 200 mm 7.5 x 8.0 in			
Terminal Housing dimensions (W x D x H)	195 x 155 x 68 mm 7.7 x 6.1 x 2.7 inch			
Base Housing dimensions (W x D x H)	230 x 260 x 98 mm 9.1 x 10.2 x 3.9 inch			
Assembled dimensions (W x D x H)	230 x 393 x 98 mm 9.1 x 15.5 x 3.9 inch			
Net weight	4.3 kg / 9.5 lb		5.0 kg / 11.0 lb	
Shipping weight	6.8 kg / 15.0 lb		7.5 kg / 16.5 lb	

Note: Default Calibration weights shown in Bold

TABLE 9-4. SPECIFICATIONS (Cont.)

MODEL	EX6201	EX10201
Capacity	6200 g	10200 g
Readability d	0.1 g	
Repeatability (std. dev.)	0.1 g	
Linearity	± 0.2 g	
Span Calibration Points	3000g, 4000g, 5000g , 6000g	2500g, 5000g, 7500g, 10,000g
Weighing units	Baht, carat, grain, gram, kilogram, mesgal, momme, Newton, ounce, pennyweight, pound, Tael (Hong Kong), Tael, (Singapore), Tael (Taiwan), tical, tola, troy ounce, custom (3)	
Applications	Weighing, Parts Counting, Percent Weighing, Check Weighing, Dynamic Weighing, Filling, Totalization, Formulation, Differential Weighing, Peak Hold, Density Determination, Pipette Adjustment, Ingredient Costing, Statistical Quality Control	
Stabilization time (typical)	Within 1 second	
Display	Full-Color VGA Graphic LCD	
Display size	5.7 in / 14.5 cm (diagonal)	
Backlight	White LED	
Controls	4-wire resistive touch screen	
Communication	RS-232, USB	
Balance power input	12 VDC, 0.5A	
Power supply	AC Adapter Input: 100-240 VAC 0.6A 50-60 Hz AC Adapter Output: 12 VDC 1.5A	
Platform size	190 x 200 mm 7.5 x 8.0 in	
Terminal Housing dimensions (W x D x H)	195 x 155 x 68 mm 7.7 x 6.1 x 2.7 inch	
Base Housing dimensions (W x D x H)	230 x 260 x 98 mm 9.1 x 10.2 x 3.9 inch	
Assembled dimensions (W x D x H)	230 x 393 x 98 mm 9.1 x 15.5 x 3.9 inch	
Net weight	5.0 kg 11.0 lb	
Shipping weight	7.5 kg 16.5 lb	

Note: Default Calibration weights shown in Bold

TABLE 9-5. SPECIFICATIONS (Cont.)

MODEL	EX224x ¹	EX324x ¹	EX423x ¹	EX1103x ¹
Max	220 g	320 g	420 g	1100 g
Min	0.01 g	0.01 g	0.02 g	0.1 g
d =	0.0001 g	0.0001 g	0.001 g	0.001 g
e =	0.001 g	0.001 g	0.01 g	0.01 g
Approval Class	I	I	II	I
Repeatability (std. dev.)	0.0001 g		0.001 g	
Linearity	± 0.0002 g		± 0.002 g	
Span Calibration Points	100g, 150g, 200g	150g, 200g, 300g	200g, 300g, 400g	500g, 1000g
Weighing units	M-Models: milligram, gram, carat N-Models: gram, milligram, carat, pennyweight, grain, ounce, troy ounce			
Applications	Weighing, Parts Counting, Percent Weighing, Dynamic Weighing, Totalization, Formulation			
Stabilization time (typical)	Within 2 seconds	Within 3 seconds	Within 1.5 seconds	
Display	Full-Color VGA Graphic LCD			
Display size	5.7 in / 14.5 cm (diagonal)			
Backlight	White LED			
Controls	4-wire resistive touch screen			
Communication	RS-232, USB			
Balance power input	12 VDC, 0.5A			
Power supply	AC Adapter Input: 100-240 VAC 0.6A 50-60 Hz AC Adapter Output: 12 VDC 1.5A			
Platform size	90 mm 3.5 in	130 mm 5.1 in		
Terminal Housing dimensions (W x D x H)	195 x 155 x 68 mm 7.7 x 6.1 x 2.7 inch			
Base Housing dimensions (W x D x H)	230 x 260 x 350 mm 9.1 x 10.2 x 13.8 inch			
Assembled dimensions (W x D x H)	230 x 393 x 350 mm 9.1 x 15.5 x 13.8 inch			
Net weight	6.9 kg 15.2 lb		7.5 kg 16.5 lb	
Shipping weight	9.7 kg 21.3 lb		10.3 kg 22.7 lb	

Note 1: M = EC Type approved

N = NTEP certified and Measurement Canada approved

Note 2: Default Calibration weights shown in Bold

TABLE 9-6. SPECIFICATIONS (Cont.)

MODEL	EX4202x ¹	EX10202x ¹	EX10201x ¹
Max	4200 g	10200 g	10200 g
Min	0.5 g	1 g	10 g
d =	0.01 g	0.01 g	0.1 g
e =	0.1 g	0.1 g	0.1 g
Approval Class	II	I	I
Repeatability (std. dev.)	±0.01 g		±0.1 g
Linearity	±0.02 g		±0.2 g
Span Calibration Points	2000g, 3000g, 4000g	2500g, 5000g, 7500g, 10,000g	2500g, 5000g, 7500g, 10,000g
Weighing units	M-Models:kilogram, gram, carat N-Models: gram, kilogram, carat, pennyweight, grain, pound, ounce, troy ounce		
Applications	Weighing, Parts Counting, Percent Weighing, Dynamic Weighing, Totalization, Formulation		
Stabilization time (typical)	Within 1 second		
Display	Full-Color VGA Graphic LCD		
Display size	5.7 in / 14.5 cm (diagonal)		
Backlight	White LED		
Controls	4-wire resistive touch screen		
Communication	RS-232, USB		
Balance power input	12 VDC, 0.5A		
Power supply	AC Adapter Input: 100-240 VAC 0.6A 50-60 Hz AC Adapter Output: 12 VDC 1.5A		
Platform size	190 x 200 mm 7.5 x 8.0 in		
Terminal Housing dimensions (W x D x H)	195 x 155 x 68 mm 7.7 x 6.1 x 2.7 inch		
Base Housing dimensions (W x D x H)	230 x 260 x 98 mm 9.1 x 10.2 x 3.9 inch		
Assembled dimensions (W x D x H)	230 x 393 x 98 mm 9.1 x 15.5 x 3.9 inch		
Net weight	4.3 kg / 9.5 lb		5.0 kg / 11.0 lb
Shipping weight	6.8 kg / 15.0 lb		7.5 kg / 16.5 lb

Note 1: M = EC Type approved

N = NTEP certified and Measurement Canada approved

Note 2: Default Calibration weights shown in Bold

9.2 Drawings and Dimensions

Fully assembled dimensions

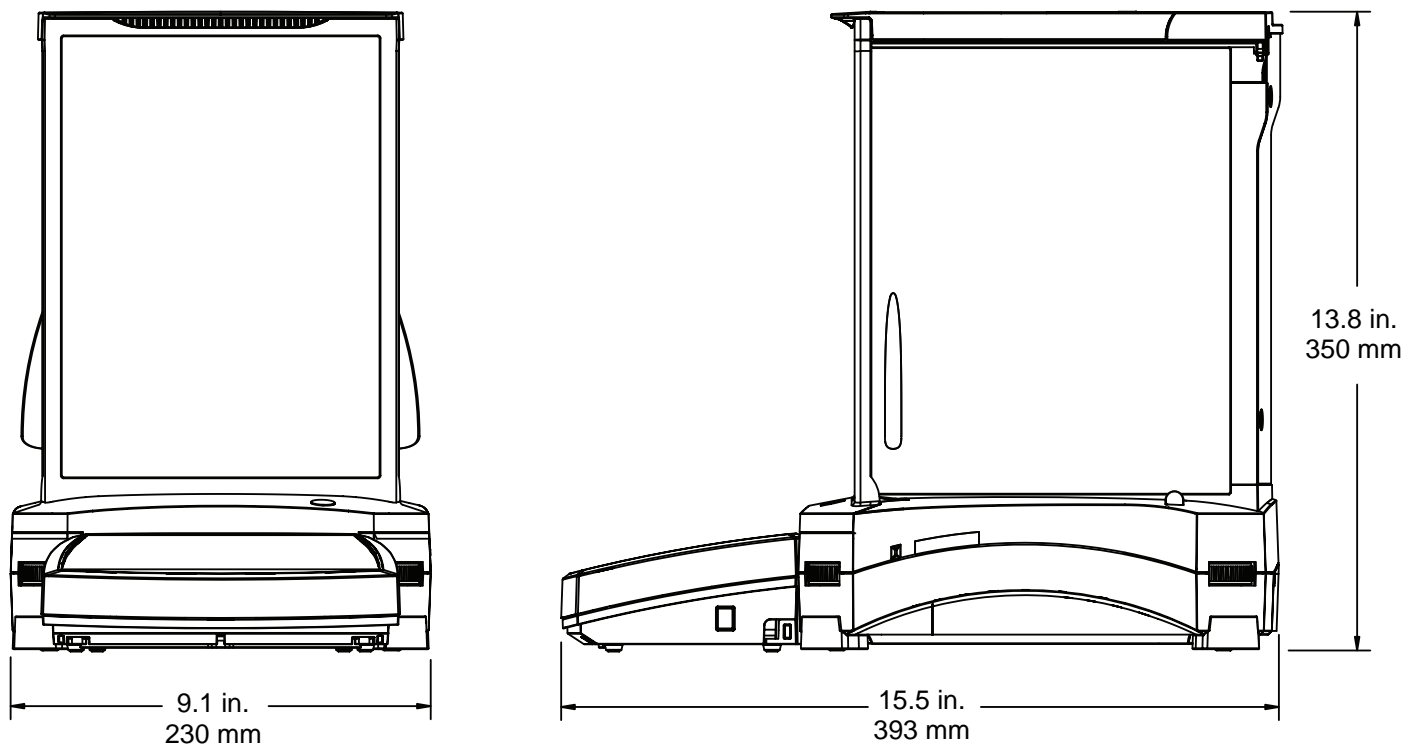


Figure 9-1. Draft Shield models

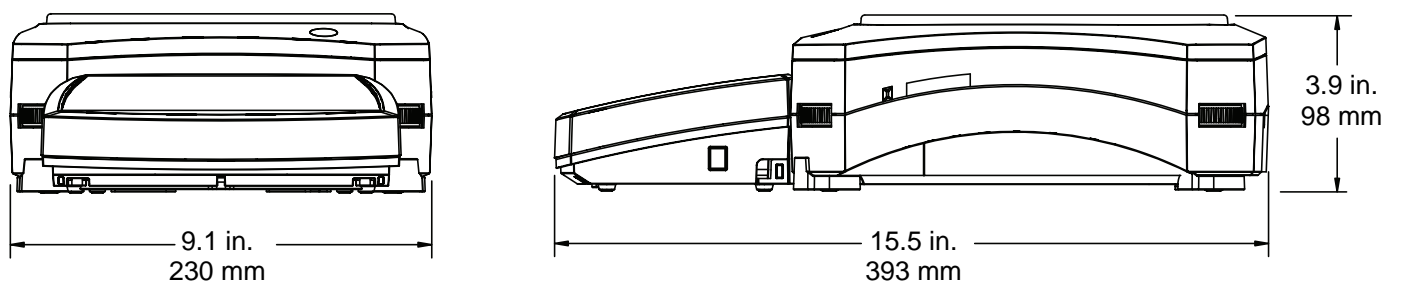


Figure 9-2. Non-Draft Shield models

9.3 Parts and Accessories

TABLE 9-7. PARTS

DESCRIPTION	PART NUMBER
Terminal in-use Cover	83033633
Universal AC Adapter (without power Cord)	46001884
Power Cord US	83033672
Power Cord EU	83033673
Power Cord UK	83033674
Power Cord AU	83033675
Power Cord JP	83033676
90 mm Pan Assembly	83033640
130 mm Pan	83033641
190 x 200 mm Pan	83033643
Front Door kit	83033677
Left Glass Door kit	83033678
Right Glass Door kit	83033679
Top Glass Door kit	83033680

TABLE 9-8. ACCESSORIES

DESCRIPTION	PART NUMBER
Foot Switch kit	83021086
Terminal Extension Cable kit	83021083
Density Determination kit	80253384
Tower Mount for Terminal	83021102
Draft Shield kit	83021084
Security Device	80850043
Printer	Contact Ohaus
Interface Cable, Printer	Contact Ohaus
Interface Cable, PC 25 pin	Contact Ohaus
Interface Cable, PC 9 pin	Contact Ohaus
Interface Cable, USB (Type A to B)	83021085
Second RS232 Option kit	83021081
Ethernet Option Kit	83021082

9.4 Icons List

TABLE 9-9. EXPLORER BALANCE ICONS






























ICON	FUNCTION	ICON	FUNCTION
	Standby		Calibration Menu
	Print		User Settings Menu
	Applications		Balance Setup Menu
	Sensors		Application Modes Menu
	AutoCal™		Weighing Units Menu
	Main Menu		GLP and GMP Data Menu
	More Functions...		Communication Menu
	Level Assist		Library
	Zero		I/O Settings menu
	Tare		Diagnostics Menu
	Units		Factory Reset Menu
	Pre-Tare		lockout Menu
	Cal Test		Information Menu
	Calculator		
	Stopwatch		
	Logout		

TABLE 9-9. EXPLORER BALANCE ICONS (Continued)






















ICON	FUNCTION	ICON	FUNCTION
	AutoCal™ Internal Calibration		Stability Indicator Range
	Automatic Calibration		Filter Level
	AutoCal™ Adjustment		Auto Zero Tracking
	Span Calibration		Auto Tare
	User Calibration		Gross Indicator
	Calibration Test		Legal For Trade
	Language		Graduations
	Volume		Date and Time
	Display Settings		
	User Manager		
	Functions Configuration		
	Sensors		
	Draft Shield Light		

TABLE 9-9. EXPLORER BALANCE ICONS (Continued)















ICON	FUNCTION	ICON	FUNCTION
	Weighing		Differential
	Parts Counting		Density Determination
	Percent Weighing		Peak Hold
	Check Weighing		Ingredient Costing
	Dynamic Weighing		Pipette Adjustment
	Filling		Statistical Quality Control
	Totalization		
	Formulation		

TABLE 9-9. EXPLORER BALANCE ICONS (Continued)

ICON	FUNCTION		ICON	FUNCTION
mg	Milligram unit		mom	Momme unit
g	Gram unit		msg	Mesghal unit
kg	Kilogram unit		HKt	Hong Kong Tael unit
ct	Carat unit		SGt	Singapore Tael unit
oz	Ounce unit		TWt	Taiwan Tael unit
ozt	Ounce Troy unit		tical	Tical unit
lb	Pound unit		tola	Tola unit
dwt	Pennyweight unit		bht	Baht unit
Grain	Grain unit		C1	Custom unit 1
N	Newton unit		C2	Custom unit 2
			C3	Custom unit 3

TABLE 9-9. EXPLORER BALANCE ICONS (Continued)




























ICON	FUNCTION	ICON	FUNCTION
	Header		Calibration Reset
	Balance Name		User Settings Reset
	User Name		Balance Setup Reset
	Project Name		Application Modes Reset
	RS 232 Standard		Weighing Units Reset
	USB Standard		GLP and GMP Data Reset
	External Input 1		Communication Reset
	External Input 2		I/O Settings Reset
	External Input 3		Reset All
	External Input 4		
	Level Bubble Light		
	Draft Shield Light		
	Sensors		
	Service Menu		

TABLE 9-9. EXPLORER BALANCE ICONS (Continued)

ICON	FUNCTION	ICON	FUNCTION
	Calibration Lockout		
	User Settings Lockout		
	Balance Setup Lockout		
	Application Modes Lockout		
	Weighing Units Lockout		
	GLP and GMP Data Lockout		
	Communication Lockout		
	Library Lockout		
	I/O Settings Lockout		
	Factory Reset Lockout		

9.5 Communication

9.5.1 Interface Commands

Commands listed in the following table will be acknowledged by the balance. The balance will return "ES" for invalid commands.

TABLE 9-10. EXPLORER INTERFACE COMMAND LIST

Command Characters ¹⁾	Function
IP	Immediate Print of displayed weight (stable or unstable). Attention: when LFT ON, IP could only print stable displayed weight.
P ¹⁾	Print displayed weight according to "Stable only" setting in the communication menu. Attention: when LFT ON, P could only print stable displayed weight.
CP	Continuous Print. Attention: when LFT ON, CP could not work.
SP ¹⁾	Print on Stability.
SLP	Auto Print stable non-zero displayed weight. Attention: the corresponding settings in the communication menu are modified too.
SLZP	Auto Print stable non-zero weight and stable zero reading. Attention: the corresponding settings in the communication menu are modified too.
xP	Interval Print x = Print Interval (1-3600 sec) 0P ends interval Print. Attention: the corresponding settings in the communication menu are modified too.
0P	See above.
H	Enter or get Print Header Lines. Attention: header text length is up to 25 characters, the setting format is "H x "header line text"; and "H x" could get the corresponding header line in the balance.
Z	Same as pressing Zero Key
T	Same as pressing Tare Key.
xT	Establish a preset Tare value in displayed unit. X = preset tare value. Sending 0T clears tare (if allowed).
PT	Prints Tare weight stored in memory.
PM	Print current application mode (weighing mode).
xM	Set current application mode to x. x depends on application, use application list ²⁾ .
M	Scroll to the next enabled mode.
PU	Print Current weighing unit: g, Kg, lb, oz, etc....
xU	Set balance to unit x: g, Kg etc. x depends on unit list ³⁾ .
U	Scroll to the next enabled unit.
ON	Brings out of Standby
OFF	Goes to Standby.
C	Begin Span Calibration, same as trigger from calibration menu. Attention: when LFT ON, the operation is not allowed.
IC	Begin internal Calibration, same as trigger from calibration menu.
UC	User Calibration (uses default weight), same as trigger from calibration menu. Attention: when LFT ON, the operation is not allowed.
AC	Abort Calibration. Attention: when LFT ON, the operation is not allowed.
xUC	Set user defined weight and trigger one user calibration. Attention: the user defined weight is only used for this command.

TABLE 9-10. EXPLORER INTERFACE COMMAND LIST (continued)

Command Characters ¹⁾	Function
PSN	Print Serial Number.
PV	Print base software version, terminal software version and LFT ON (if LFT is set ON).
x#	Set Counting APW (x) in grams. (must have APW stored)
P#	Print Counting application APW.
x%	Set Percent application reference weight (x) in grams. (must have reference weight stored)
P%	Print Percent application reference weight.
xAW	Set Dynamic Weigh Level to x. (x = 1 - 99 seconds)
xAW	Set Dynamic Weigh Mode. x = A (Automatic), S (Semi-Automatic), M (Manual)
PAW	Print Dynamic Weigh Level.
BAW	Start Dynamic Weigh cycle. (Manual Mode)
CW	Clear locked weight (weight < threshold) in Dynamic Weigh (same as button "Reset") & Display Hold (same as button "End Peak Hold").
xCO	Set Checkweighing Over Limit in grams x.
xCU	Set Checkweighing Under Limit in grams x.
PCO	Print Checkweighing Over Limit.
PCU	Print Checkweighing Under Limit.
xCM	Set Checkweigh mode (1=over/under, 2=target/% tolerance, 3=Target/weight tolerance)
xCT%	Set Checkweighing target in grams x for percent tolerance mode.
PCT%	Print Checkweighing Target for percent tolerance mode.
xCTW	Set Checkweighing target in grams x for weight tolerance mode.
PCTW	Print Checkweighing Target for weight tolerance mode.
xC%	Set Checkweighing % tolerance x. Attention: when x is a positive value, it is used to set the +tolerance value; vice versa.
PC%	Print Checkweighing % tolerance.
xCW	Set Checkweighing weight tolerance x. Attention: when x is a positive value, it is used to set the +tolerance value; vice versa.
PCW	Print Checkweighing weight tolerance.
xDH	Set Display Hold mode (Peak Hold). x = A (Automatic), S (Semi-Automatic), M (Manual)
xD	Set 1 second print delay (set x = 0 for OFF, or x = 1 for ON).
xFL	Set filter level to x (1 = low, 2 = med, 3 = high).
xAL	Set Auto-zero to x (x = 1 for 0d, x = 2 for 0.5d, x = 3 for 1d, x = 4 for 3d).
Esc R	Resets all Balance menus to factory defaults. Attention: The binary code of this commands is "1B 20 52 0D 0A" or "1B 52 0D 0A".
PID	Print current user Name.
xID	Program user Name. Attention: only allowed numeric input.
xTL	Set Totalize Mode. x = A (Automatic), M (Manual).
PTIME	Print current time.
PDATE	Print current date.
xTIME	Set Time, x format: hh:mm:ss.
xDATE	Set Date, x format: mm/dd/yyyy.
CA	Continuous weight, same as CP.
SA	Stable load, same as SLP.
xA	Interval Print x = interval in sec (1-3600) 0 = off, same as xP.
0A	Set AutoPrint off, same as 0P.
SC	Begin Span Cal, same as C.
xAM	Set Animal Mode to Auto, Semi-Auto, Manual. Same as xAW(A/S/M)
?	Prints current mode, same as PM.
xS	0 = print unstable data, same as IP; 1 = print stable only ¹⁾ , same as SP.
xRL	0 = disable response; 1 = enable response. This command only controls the "OK!" response.

General Notes:

Commands sent to the indicator must be terminated by a carriage return-line feed (CRLF).

Alternate command characters may be defined by the user.

Data output is always terminated with a carriage return-line feed (CRLF).

Note 1) There is 40-second timeout control for print under stable requirement. If the unstable condition continues over 40 seconds, balance will respond "ES".

Note 2) Application list:

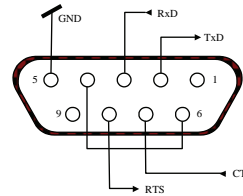
Index	Application		Index	Application
0	Weighing		11	Pipette Adjustment
1	Parts Counting		12	Ingredient Adjustment
2	Percent Weighing		13	SQC
3	Check Weighing			
4	Dynamic Weighing			
5	Filling			
6	Totalization			
7	Formulation			
8	Differential			
9	Peak Hold			
10	Density Determination			

Note 3) Unit list:

Index	Unit		Index	Unit
0	Milligram		11	Mesghal
1	Gram		12	Hong Kong Tael
2	Kilogram		13	Singapore Tael
3	Carat		14	Taiwan Tael
4	Ounce		15	Tical
5	Ounce Troy		16	Tola
6	Pound		17	Baht
7	Pennyweight		18	Custom Unit 1
8	Grain		19	Custom Unit 2
9	Newton		20	Custom Unit 3
10	Momme			

9.5.2 RS232 (DB9) Pin Connections

- Pin 2: Balance transmit line (TxD)
- Pin 3: Balance receive line (RxD)
- Pin 5: Ground signal (GND)
- Pin 7: Clear to send (hardware handshake) (CTS)
- Pin 8: Request to send (hardware handshake) (RTS)



9.6 The USB Interface

The Ohaus USB Interface is a unique solution to the problem of connecting a balance to a computer using a Universal Serial Bus (USB). USB devices are categorized into classes such as disk drives, digital cameras, printers, etc. Balances do not have a commonly used class so the Ohaus USB interface uses a generic interface based on the RS232 serial standard.

Data sent from the balance to a computer is in USB format. The USB data is directed to a *virtual port*. This port then appears as an RS232 port to the application program.

When sending a command from a computer to the balance, the application program sends a command to the *virtual port* as if it were an RS232 port. The computer then directs the command from the *virtual port* to the computer's USB connector where the balance is connected. The port receives the USB signal and reacts to the command.

The USB Interface includes a CD with the software drivers to create the required *virtual port* on the computer.

System Requirements

- PC running Windows 98®, Windows 98SE®, Windows ME®, Windows 2000®, Windows XP® or Windows 7®
- Available USB port (Type A, 4-pin, female)

USB Connection

The balance's USB port terminates with a 4-pin, female, USB Type B connector.

A USB Cable (type B/male to type A/male) is required (not supplied).

1. Ensure that the balance is powered on and working properly.
2. Power on the computer and verify that its USB port is enabled and working properly.
3. Plug the cable's USB connectors into the computer's USB port and the balance's USB port. Windows® should detect a USB device and the New Hardware Wizard will be initialized.

Virtual Port Software Installation

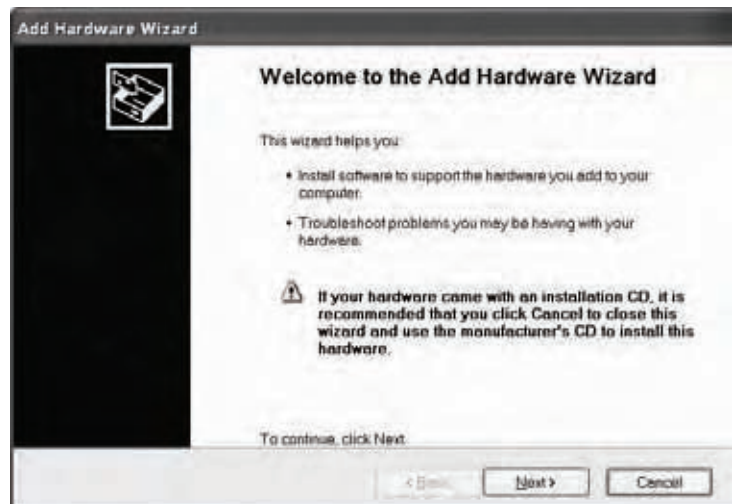
1. Insert the supplied CD into the computer's CD drive.

Different versions of Windows® have slightly different steps to load the driver that is on the CD. In all versions the New Hardware Wizard guides you through the required steps to select the driver that is located on the CD.

2. After clicking Finish, the virtual port should be ready for use.

Windows® typically adds the virtual port in sequence after the highest number COM port. For example, on PC's equipped with up to 4 COM ports, the virtual port will be COM5.

When using the USB interface with programs that limit the number of COM port designations (e.g. Ohaus MassTracker allows only COM1, 2, 3, & 4), it may be necessary to assign one of these port numbers to the new virtual port.



Example of Windows XP Hardware Wizard

This can be done in the Port Settings of the Device Manager utility, found in the Windows Control Panel.

Balance Setup FOR USB INTERFACE

- A) The Ohaus Interface is preset to communicate using the following settings:
2400 baud, 7 bit, no parity, no handshake.
 To use different settings, it will be necessary to change either the balance settings, or the computer settings.
- B) Configure the balance to the desired USB and printing parameters.

PRINT

Stable

On, Off

A-Print

Cont, On.Stbl, On.Acc*, 5sec, 15sec, 30sec,
60sec, off

End

Yes, No

*Note: Print and USB menu selections may
 vary between the different balance series.

USB

USB

On / Off

Baud

600, 1200, 2400, 4800, 9600, 19200

Parity

7-even, 7-odd, 7-none, 8-none

Handshake

None, Xon-Xoff, RTS-CTS

END

Yes, No

SETUP DEFINITIONS

PRINT / Stable – On

Balance transmits stable data only.

PRINT / Auto Print – Continuous

Balance repeatedly sends data as fast as possible.

PRINT / Auto Print – On Stable

Balance automatically outputs data upon stability.

PRINT / Auto Print – (xx) sec

Balance sends data every (xx) seconds.

PRINT / Auto Print – Off

Only sends data when PRINT is pressed.

USB / USB – Off

Turns Interface off, saving battery power.

USB / Baud, Parity, Handshake

Set parameters to match printer or computer.

Operation**USB OUTPUT**

With the Adapter installed the balance will operate in one of the following three ways:

- USB = On, Auto Print = Off, Stable = On or Off
 Press PRINT to send the display data based on the settings in the Menu.
 If Stable is set to On, the balance will wait for a stable reading before sending data.
- USB = On, Auto Print = On, Stable = On or Off
 The balance will automatically send data.
 If Stable is set to On, only stable values will be sent.
- USB = Off
 The interface is turned off.

Data sent from the Interface is in standard ASCII format terminated with a [CRLF] (carriage return-line feed). The output format is as follows:

[weight]	10 characters (right justified)
[space]	1 character
[unit]	5 characters max (left justified)
[space]	1 character
[stability indicator]	1 character "?" when unstable, blank when stable
[space]	1 character
[legend]	10 character TOTAL, hh:mm:ss(time interval), etc.
[CR]	1 character
[LF]	1 character

Output examples: (Note: * and _ indicate spaces)

```
*****192.21_g
*****0.01_g_?

*****0.01_g__ 00:00:00
*****176.30_g_?_00:00:15
*****192.08_g__ 00:00:30

*****192.21_g
*****207.80_g_TOTAL
```

– **Manual, Continuous or On-Stable printing**
unstable reading

– **Interval Printing (example:15sec interval)**
unstable reading

– **Accumulate Mode (Manual printing only)**

USB INPUT

The balance will respond to various commands sent via the interface adapter. Terminate the following commands when with a [CR] or [CRLF].

Explorer Commands

?	print current mode
0A	turn Auto-print off
SA	Auto-print on, prints on stability
CA	Continuous Auto-print
(n)A	Auto-print on 1 to 3600 second intervals (n = 1 to 3600)
C	perform span calibration
L	perform linearity calibration
0M	gram mode
1M	ounce mode
2M	troy ounce mode
3M	pennyweight mode
4M	parts counting mode
5M	pound mode
T	tare balance, same as pressing ON-ZERO
V	print software version
(Esc)R	reset balance to factory defaults
P	same as pressing PRINT
LE	print last error code, i.e. [Err 0]
0S	print unstable data
1S	print stable data only
P	same as pressing Print
SP	print stable weight only
IP	immediate print of displayed weight (stable or unstable)
CP	Continuous print of weights
SLP	Auto-print stable non-zero weight only
SLZP	Auto-print stable non-zero weight and zero reading
xP	Auto-print on 1 to 3600 second intervals (x = 1 to 3600)
0P	turns auto-print off
PM	print current mode
M	advance to the next enabled mode
PU	print current unit
U	advance to the next enabled unit
T	same as pressing Tare
Z	same as pressing Zero
PV	print software version

Auto-Print Operation

Once Auto-Print is activated in the menu, the balance will send data as required.

To temporarily stop Auto-Printing, press PRINT.

If there is data in the print buffer the printer will finish printing this data.




A second press will resume Auto-Printing.



10. SOFTWARE UPDATES

Ohaus is continuously improving its balance software. To obtain the latest release, please contact your Authorized Ohaus Dealer or Ohaus Corporation.

11. COMPLIANCE

Compliance to the following standards is indicated by the corresponding mark on the product.

Mark	Standard
	This product conforms to the EMC Directive 2004/108/EC, the Low Voltage Directive 2006/95/EC and the Non-automatic Weighing Instruments Directive 2009/23/EC. The complete Declaration of Conformity is available online at www.ohaus.com .
	AS/NZS CISPR 11, AS/NZS 61000.4.3
	CAN/CSA-C22.2 No. 61010-1-04 UL Std. No. 61010-1

	<p>Important notice for verified weighing instruments</p>
	<p>Weighing instruments verified at the place of manufacture bear one of the preceding marks on the packing label and the green 'M' (metrology) sticker on the descriptive plate. They may be put into service immediately.</p> <p>Weighing instruments to be verified in two stages have no green 'M' (metrology) on the descriptive plate and bear one of the preceding identification marks on the packing label. The second stage of the initial verification must be carried out by the approved service organization of the authorized representative within the EC or by the national weights and measures (W+M) authorities.</p> <p>The first stage of the initial verification has been carried out at the manufacturer's work. It comprises all tests according to the adopted European standard EN45501:1992, paragraph 8.2.2.</p> <p>If national regulations limit the validity period of the verification, the user of the weighing instrument must strictly observe the re-verification period and inform the respective W+M authorities.</p>

FCC Note

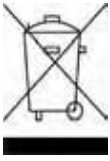
This equipment has been tested and found to comply with the limits for a Class A digital device, pursuant to Part 15 of the FCC Rules. These limits are designed to provide reasonable protection against harmful interference when the equipment is operated in a commercial environment. This equipment generates, uses, and can radiate radio frequency energy and, if not installed and used in accordance with the instruction manual, may cause harmful interference to radio communications. Operation of this equipment in a residential area is likely to cause harmful interference in which case the user will be required to correct the interference at his own expense.

Industry Canada Note

This Class A digital apparatus complies with Canadian ICES-003.

ISO 9001 Registration

In 1994, OHAUS Corporation, USA, was awarded a certificate of registration to ISO 9001 by Bureau Veritas Quality International (BVQI), confirming that the OHAUS quality management system is compliant with the ISO 9001 standard's requirements. On May 21, 2009, OHAUS Corporation, USA, was re-registered to the ISO 9001:2008 standard.

**Disposal**

In conformance with the European Directive 2002/96/EC on Waste Electrical and Electronic Equipment (WEEE) this device may not be disposed of in domestic waste. This also applies to countries outside the EU, per their specific requirements.

The Batteries Directive 2006/66/EC introduces new requirements from September 2008 on removability of batteries from waste equipment in EU Member States. To comply with this Directive, this device has been designed for safe removal of the batteries at end-of-life by a waste treatment facility.

Please dispose of this product in accordance with local regulations at the collecting point specified for electrical and electronic equipment.

If you have any questions, please contact the responsible authority or the distributor from which you purchased this device.

Should this device be passed on to other parties (for private or professional use), the content of this regulation must also be related.

For disposal instructions in Europe, refer to www.ohaus.com, choose your country then search for WEEE.

Thank you for your contribution to environmental protection.

LIMITED WARRANTY

Ohaus products are warranted against defects in materials and workmanship from the date of delivery through the duration of the warranty period. During the warranty period Ohaus will repair, or, at its option, replace any component(s) that proves to be defective at no charge, provided that the product is returned, freight prepaid, to Ohaus.

This warranty does not apply if the product has been damaged by accident or misuse, exposed to radioactive or corrosive materials, has foreign material penetrating to the inside of the product, or as a result of service or modification by other than Ohaus. In lieu of a properly returned warranty registration card, the warranty period shall begin on the date of shipment to the authorized dealer. No other express or implied warranty is given by Ohaus Corporation. Ohaus Corporation shall not be liable for any consequential damages.

As warranty legislation differs from state to state and country to country, please contact Ohaus or your local Ohaus dealer for further details.



Test Equipment Depot - 800.517.8431 - 99 Washington Street Melrose, MA 02176 - TestEquipmentDepot.com



* 8 3 0 2 1 1 7 1 *

P/N 83021171 © 2011 Ohaus Corporation, all rights reserved.