

# **FISHER**<sup>®</sup> RESEARCH LABS

## **TW9000**

### **Multi-Frequency Underground Utility Locator**



**High Capacity  
Rechargeable  
Battery System**



**OPERATOR'S MANUAL**

## SAFETY WARNINGS

<p><b>! WARNING!</b> THIS EQUIPMENT FOR USE BY PROFESSIONALLY TRAINED AND FULLY QUALIFIED PERSONNEL ONLY.</p>
<p><b>! WARNING!</b> Read this Operator's Manual before operating this equipment.</p>
<p><b>! WARNING!</b> If this equipment is used in a manner not specified by the manufacturer, the protection provided by the equipment may be impaired.</p>
<p><b>! WARNING!</b> The transmitter has the capacity to emit potentially fatal voltages.</p>
<p><b>! WARNING!</b> Never connect directly to live conductors. - POTENTIALLY LETHAL.</p>
<p><b>! WARNING!</b> Do not use in damp or wet locations.</p>
<p><b>CAUTION:</b> Thoroughly check batteries for any signs of damage prior to use.</p>
<p><b>CAUTION:</b> Neglecting safety cautions may damage equipment or property.</p>
<p><b>! WARNING!</b> Batteries can become hot; use caution when removing. Before removing the Transmitter battery pack, power OFF the device and disconnect all cables.</p>
<p><b>CAUTION:</b> Exercise extreme caution while applying signals to pipes or cables and ensure that other technicians working on the line are properly informed. Do not leave transmitter unattended if children, pets or individuals not experienced with high voltage equipment are in the area. Before removing the Transmitter battery pack, power OFF the device and disconnect all cables.</p>
<p><b>CAUTION:</b> If you suspect battery failure or physical damage to the battery, contact an authorized repair center to arrange for investigation and repair. Local, national or IATA transport regulations might govern the shipment of faulty batteries. Check with your courier to ensure compliance with restrictions and follow best transportation practice guidelines.</p>
<p><b>CAUTION:</b> Do not tamper with or disassemble the battery packs.</p>
<p><b>! WARNING!</b> Before establishing or disconnecting a direct connection lead to a utility service, make sure to switch OFF the Transmitter.</p>
<p><b>CAUTION:</b> The acceptable charging temperature range is between 32° to 113°F (0° to 45° C). Do not attempt to recharge your batteries outside of this specified temperature range.</p>
<p><b>! WARNING!</b> This device is not certified as intrinsically safe. Do not use it in areas where hazardous gases may be present.</p>
<p><b>CAUTION:</b> Do not use the Coupling Clamp around uninsulated live conductors.</p>
<p><b>! WARNING!</b> The TW9000 will not detect all utilities, such as nonconductive pipe or conductors carrying no current or low current.</p>
<p><b>! WARNING!</b> Do not rely on depth measurement for excavation. Operator skill and utility characteristics impact depth measurement accuracy.</p>
<p><b>CAUTION:</b> Use only the battery charging equipment provided by Fisher Research Labs. The use of alternative chargers could pose a safety hazard and shorten the battery's lifespan.</p>
<p><b>CAUTION:</b> For highest accuracy, avoid taking depth measurements near bends or connections in the line. Maintain a distance of at least 15ft (4.5m) from a bend for accurate depth measurements.</p>
<p><b>! WARNING!</b> To clean Transmitter, power down, disconnect all cables and remove battery.</p>





## ⚠ TRANSMITTER SAFETY INSTRUCTIONS ⚠

- 1 Before applying any energy to the utility, the Operator must inform all other personnel working on the same utility.
 



Also, if any persons could possibly come into contact with the energized utility, advise these people of the energized utility's potential shock hazard and to avoid all contact with the utility.
- 2 Make sure that the Transmitter is powered OFF.
- 3 Inspect the Conductive Tracing Cables for any damage to the conductive clips.
 

In case of damage, do not use them; find a replacement.
- 4 Identify a location to ground to earth and push the Grounding Rod into the ground.
 







Connect the black alligator clip to the Grounding Rod.
- 5 Identify the conductive connection point on the utility to be energized.
 

Connect the red alligator clip at this point.
- 6 Lift the protective cap on the Transmitter and plug in the Conductive Tracing Cable.
- 7 Power the Transmitter ON.
- 8 Press  until the screen displays the volts (V) units (near the center of the screen).
- 9 **If the transmit voltage measures more than 25.0V, the utility is energized to a potentially hazardous voltage.**
  -  will be displayed.
  - **Do not use this device to trace this energized utility line.**
- 10 If no hazardous voltage is present, apply the output power.
  - Press  to reach the desired output level.
- 11 Press  to monitor the output current (mA) and resistance (kΩ).
- 12 If the Transmitter displays + , there is an open circuit, probably the result of a poor connection.
 

An adjustment to the connection may be necessary:

  - To adjust the connection, press  to reduce the output power to zero bars .
  - Alternatively, power the Transmitter OFF.
  - Inspect and verify the red and black alligator clip connections, one at a time, and return to step 7.

**CONTENTS**

<b>Safety Warnings</b> . . . . .	2-4
<b>Introduction</b> . . . . .	6
<b>Product Overview</b> . . . . .	7-8
Transmitter . . . . .	9
Receiver . . . . .	10
<b>Transmitter</b>	
Controls and Operation . . . . .	11-13
Display . . . . .	14-15
Display Icons . . . . .	16-17
<b>Receiver</b>	
Start-up and Programming . . . . .	18
Get Ready to Operate . . . . .	19
Deploy . . . . .	20-26
Keypad . . . . .	27
Display Icons . . . . .	28-29
<b>Utility Locating Basics</b> . . . . .	30-33
<b>Transmitter Operating Modes</b>	
Direct Connection . . . . .	34
Coupling Clamp . . . . .	36
Inductive . . . . .	38
<b>Receiver Operating Modes</b>	
Peak & Null  . . . . .	40
Wide Peak  . . . . .	41
Narrow Peak  . . . . .	42
Null  . . . . .	42
Sonde  . . . . .	43
Passive Power  . . . . .	46
<b>Battery Management</b> . . . . .	47-52
<b>Industry links, Specifications, Warranty</b> . . . . .	53-56

## INTRODUCTION

The TW9000 is a rugged multi-frequency underground utility locating system employing digital signal processing technology to enable the operator to locate and trace buried utilities quickly and accurately.

To achieve the safest and most efficient results from this system, study this manual to understand the system's features, operations and maintenance. Pay close attention to the TW9000's safety features and warnings.

### QUALITY

Fisher locating products are renowned for their quality. Each detector is manufactured with pride in the USA. Our manufacturing facilities are certified to ISO9001:2015 and IPC-A-610 standards.

### PERFORMANCE

Utility industries worldwide rely on Fisher for damage prevention and identification. Our instruments are robust, highly accurate and locate deeper.

### REPUTATION

Fisher produced the first patented ground-penetrating metal detector in 1931. For over 90 years, the Fisher logo has been the mark of ground-penetrating excellence.

**Caution:** Both Transmitter and Receiver must be set to your local power line frequency, 50Hz or 60Hz.

**Transmitter:** Use . See instruction, page 10.

**Receiver:** Use  + . See instruction, page 18.

The default setting is 60Hz.

**CAUTION:**  
**Failure to set Transmitter to your  
powerline frequency could result in  
damage to the Transmitter.**

## PRODUCT OVERVIEW

The TW9000 underground utility locating system includes the following standard components:

- **Transmitter.** Energizes buried utilities using operator-selectable connection methods.
- **Receiver.** Detects active and passive magnetic fields emitted from energized buried utilities.
- **Conductive Connection Kit.** Cables and Ground Rod for conductive tracing.
- **Transmitter Rechargeable Battery Kit**
- **Receiver Rechargeable Battery Kit**
- **Carrying Case**
- **Operator's Manual**

## Optional Accessories available



Figure 1. 5-inch Coupling Clamp  
item # CCLAMP-5-MF



Figure 2. Sondes for 4-inch pipe  
(512Hz, 8kHz, 33kHz, 82kHz)



Figure 3. Transmitter DC Power Adapter  
for vehicles. item # TW9KTX-CARPWR

**STANDARD SYSTEM COMPONENTS**



**Conductive Connection Kit**  
(Ground-Rod & Conductive Tracing Cables)



**Carrying Case**



**Transmitter**  
**Rechargeable Battery**



**Operator's**  
**Manual**



**Receiver**



**Transmitter**



**Receiver**  
**Rechargeable Battery**

Figure 4.

**TRANSMITTER OVERVIEW**

The TW9000 Transmitter is a powerful state-of-the-art multi-frequency signal generator designed to efficiently energize buried utilities from an above-ground location. It provides three means of connecting to a utility:

- **Direct Connection.** The preferred method of connection, capable of transferring the most power to the utility.
- **Coupling Clamp.** A connection method using the accessory Coupling Clamp to transfer power inductively to an exposed utility conduit.
- **Inductive.** When no Direct Connection or Coupling Clamp access points are available, this method transfers power through the ground inductively to the utility.

Controls are provided to select tracing frequencies (512 Hz, 8 kHz, 33 kHz, and 82 kHz), adjust both the intermediate and maximum output levels applied to the utility, and to adjust the audio alert volume level. A backlit LCD communicates operating parameters, connection status and warnings.

Powered by a rechargeable 14.4 volt lithium-Ion battery, the Transmitter features a battery-saving feature to automatically turn off after a specified period of key-press inactivity.



Figure 5. TW9000 Transmitter



## RECEIVER OVERVIEW

The TW9000 Receiver detects active and passive magnetic fields emitted from buried utilities and sub-surface transmitters (sondes). Select from six operating modes, each configured to respond to the magnetic field characteristics inherent in different locating scenarios.

Operating modes include:

- **Peak & Null.** Use this automated mode for most standard underground utility locating scenarios.
- **Wide Peak.** Use for lateral lines far from the connection point or for deeply buried utilities.
- **Narrow Peak.** Use for congested utilities.
- **Null.** Use for utilities with low field-shape distortion.
- **Sonde.** Use with sondes to trace conduit, pipe and drain locations and their blockages.
- **Passive Power.** Use for utilities that are energized by AC power currents. This mode does not operate with the Transmitter's power source.

Controls allow the operator to select the frequency (512 Hz, 8 kHz, 33 kHz, 82 kHz), adjust the gain and volume, and measure both the depth and energizing current of buried utilities. These controls, along with visual indicators (directional-left/right/azimuth/over-target and signal strength) and audio feedback, identify and communicate the location, direction and depth of utilities. The Receiver has an energy-saving feature to automatically turn off after a specified period of key-press inactivity.











Figure 6. TW9000 Receiver







**TRANSMITTER - CONTROLS AND OPERATION**









 **Power** Press to turn ON.  
Press-and-hold to turn OFF.  
REMINDER: New battery is shipped in sleep-mode.  
Wake up in charger before first use.



 **Program Operating Parameters**

1st Press:  Auto-Power-Down timer  
Use  and  to set the timer, in minutes. When the Auto-Power-Down timer is set to , the Transmitter will automatically turn off after the specified number of minutes have passed with no key-press activity.





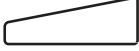

2nd Press:  Auto-Power-Down ON/OFF  
Use  and  to turn this function  or .

3rd Press:  Set Maximum Voltage for Direct Connection mode  
Use  and  to select ,  or  volts maximum output. The voltage selected applies to *ALL* frequencies. This feature is provided for safety purposes.

4th Press:  Set Maximum Power for Direct Connection mode  
Use  to choose a frequency at which to set a maximum power level. Each press of  toggles among the available frequencies:  or  or  kHz.  
After selecting the frequency, use  and  to choose the maximum power setting.  
There are eleven (11) available power settings.

 No current; no power transmission  Maximum current for maximum power

Many locating scenarios do not require maximum power. This feature allows the user to set (or reduce) the power output to only the amount required in order to conserve battery capacity, extending the operating time between battery recharges.

5th Press:  Frequency Selection  
Use  and  to set the Transmitter to your local power utility frequency, either  or  Hz. Factory default is  Hz.

**Caution:** Failure to set Transmitter to your powerline frequency could result in damage to the Transmitter.

6th Press:  Exit programming mode

TRANSMITTER - CONTROLS AND OPERATION



Measure

For Direct Connection mode only

1st Press: Battery status and output level control.

Displays the time remaining before recharging is required, in both hour/minutes and percent capacity remaining.

Example: 6:25 bat min 40%

The values displayed apply to the frequency indicated at the top of the display.

To measure the battery time remaining at a different frequency, first select the frequency using **f** and then engage the **T** function. Use **↑** and **↓** to change the output level.



The 10-segment bar graph displays the amount of current the operator wants to apply to the utility.

2nd and 3rd Presses: Measure and Monitor

Monitor the status of the connection to the utility while changing the output level.

Use **↑** and **↓** to change the output level.



The 10-segment bar graph indicates the amount of current the operator wants to apply to the utility.

The Transmitter applies the operator's input gradually; wait for the display values to settle.

2nd Press Measurement:

Displays the voltage (V) and power (W) resulting from the desired current, chosen with **↑** or **↓**.

3rd Press Measurement:

Displays the resistance (kΩ) and current (mA) resulting from the desired current, chosen with **↑** or **↓**.

**Note:** As the operator adjusts the current using **↑** and **↓** (during either the 2nd or 3rd press of **T**), the resultant condition of the direct connection is displayed.

The desired current input, as displayed by , does not change from the 2nd to 3rd key-press.

Only the display of the electrical connection conditions will change:

2nd Press    V and W

3rd Press    kΩ and mA

**TRANSMITTER - CONTROLS AND OPERATION**



**Volume**

Set the speaker volume from silent ( ) to high ( ).  
 The volume control applies to the high voltage warning signal and key-press volume. Key-press volume cannot be silenced.



**Frequency Selection**

Select operating frequency: 512 Hz, 8.125 kHz, 33.025 kHz or 82.175 kHz.  
 The exact frequencies are 512Hz, 8.125kHz, 33.025kHz and 82.175 kHz.  
 The TW9000 will always power-up in the frequency last selected.  
**f** is also used within the programming function to choose the frequency at which to set the maximum power level.



**Up/Down Keys**



1. To change the output level (apply more or less current):
  - In any mode, at any time, if not actively programming.
  - While using the function.
2. To select options when using function.

**To display software serialization**

1. Start with Transmitter ON.
2. While you press-and-hold , tap .
  - Displays software version (Rev )
 Repeat +
  - Displays software date YR MO DA
 Repeat +
  - Displays software serial #
 Note: the software serial # is different from the product's serial #

**TRANSMITTER DISPLAY**

WHEN OPERATING IN **DIRECT CONNECTION** mode

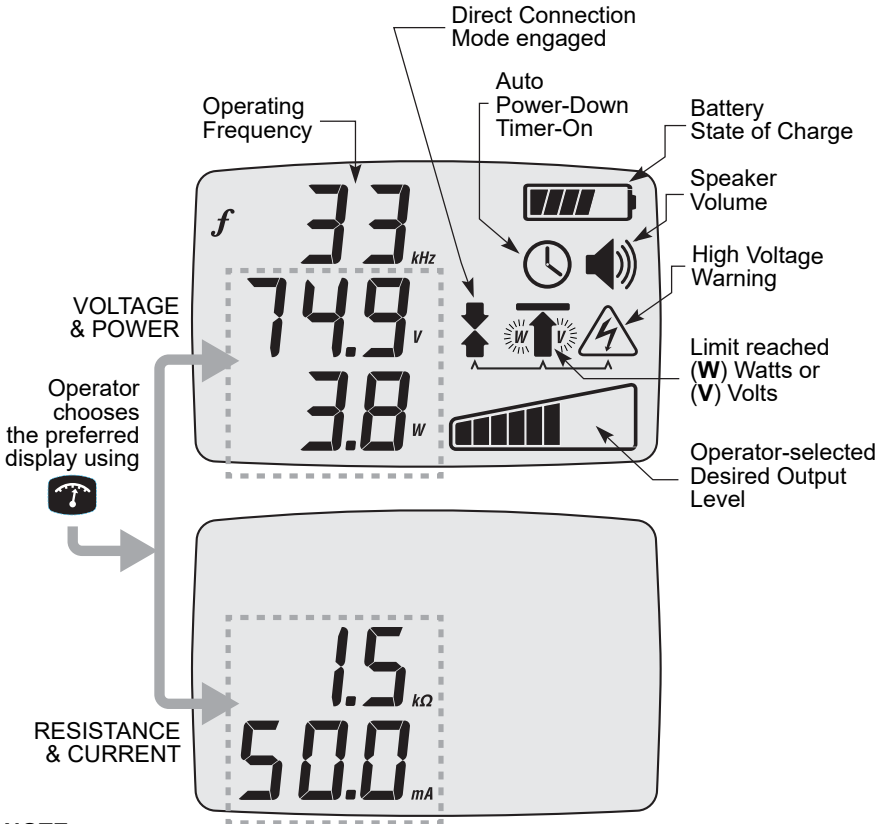

**NOTE:**

Pressing  toggles among 3 different displays:

- 1- Battery Status
- 2- **V** (volts) & **W** (watts)
- 3- **kΩ** (resistance) and **mA** (current)

Reference:

- Compare current (**mA**) value on the Receiver to the Transmitter current (**mA**) value to verify that operator is tracing the desired utility.
- Resistance (**kΩ**) shows quality of connection to ground.
- Voltage (**V**) and power (**W**) values indicate when limit has been reached.

**TRANSMITTER DISPLAY**

WHEN OPERATING IN **INDUCTIVE** mode (\*)

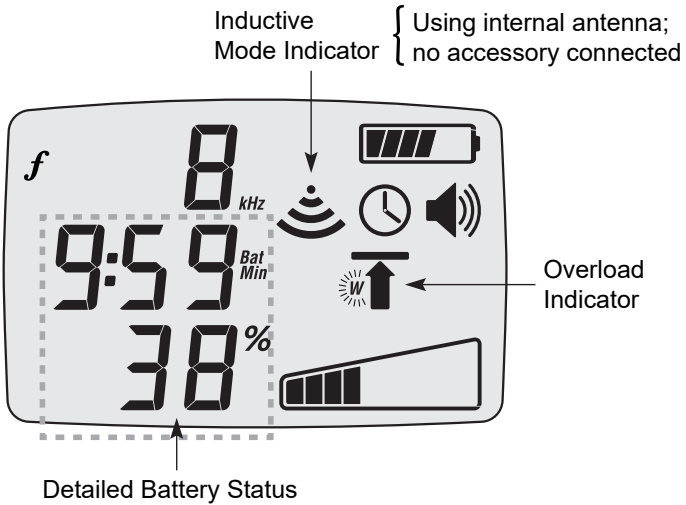



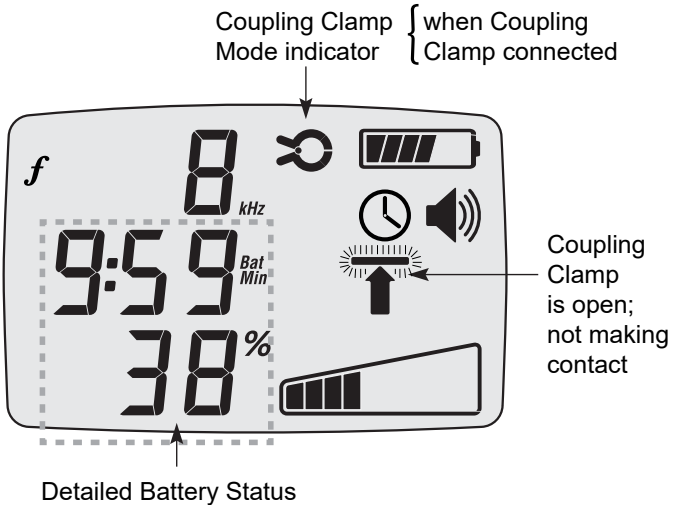







WHEN OPERATING IN **COUPLING CLAMP** mode (\*)



\* Voltage/power and resistance/current measurements are not available in Inductive or Coupling Clamp modes.

**TRANSMITTER Display Icons**

Icon	Description
	<p><b>High Voltage Warning.</b> Indicates the presence of hazardous voltage at the transmitter terminals.</p> <p>The hazard can result from the connection to an unintentionally energized utility or from the Transmitter output.</p>
	<p><b>Auto Power Down.</b> Illuminates when Auto Power Down function is on. Flashes just before Transmitter turns off.</p>
	<p><b>Direct Connection Mode.</b> When the Conductive Tracing Cables are plugged into the accessory jack, this icon indicates that the Transmitter is operating in Direct Connection mode.</p>
	<p><b>Coupling Clamp Mode.</b> When the Coupling Clamp accessory is plugged into the accessory jack, this icon indicates that the Transmitter is operating in Coupling Clamp mode.</p>
	<p><b>Inductive Mode.</b> When no accessory is plugged into the accessory jack, this icon indicates that the Transmitter is operating in Inductive mode.</p>
	<p><b>Voltage Limit Indicator.</b> When icon appears, the output voltage has reached its limit. The limit is the default setting or a lower limit as set by the operator.</p>
	<p><b>Power Limit Indicator.</b> When icon appears, the output power has reached its limit. The limit is the default setting or a lower limit as set by the operator.</p>
	<p><b>Inductive Overload.</b></p> <ul style="list-style-type: none"> <li>• W is flashing.</li> <li>• Move Transmitter away from metal object.</li> </ul>
	<p><b>Open Indicator, Coupling Clamp</b></p> <ul style="list-style-type: none"> <li>• Horizontal bar is flashing.</li> <li>• Coupling Clamp is connected but open; ends not making contact.</li> </ul>
	<p><b>Output Level.</b> Indicates the amount of current the operator desires to apply to the utility (the desired output level).</p>

**TRANSMITTER Display Icons**



Icon	Description
	<b>Frequency.</b> Displays the selected transmit frequency.
	<b>Output Measurements.</b> Displays the output measurements selected by the operator using the  key. The measurement readings are displayed in (V)volts & (W)watts or (kΩ)kohms & (mA)milliamperes. These measurement readings are displayed when the Transmitter is in the Direct Connection mode only. <b>Note:</b> Available in Direct Connection mode only.
	<b>Set Max Voltage.</b> Use . At 3rd press, set the output voltage limit using  and .
	<b>Set Max Power (Wattage).</b> Operator must first select the frequency to which the power limit applies. Press  to select frequency. Then use . At the 4th press set the wattage limit, using  and .
	<b>Battery Time Remaining.</b> Displays estimated time remaining (as currently operating) before the Transmitter will deplete battery charge and shut down. <b>Important:</b> Different operating parameters consume more or less battery power.
	<b>Battery Percentage.</b> Displays the percentage level of the battery's charge.
	<b>Battery Status.</b> Indicates the battery charge level in bars. When the battery is near complete-discharge, the battery outline flashes.
	<b>Speaker Volume.</b> Off, low, medium, high.
	<b>Open Circuit</b> The utility circuit path measures more than 10 kΩ of resistance. Requires operator intervention.

















**RECEIVER START-UP & PROGRAMMING**



 **Power**

- Press to turn ON (or press-and-hold).
- Tap to toggle backlight  ON or OFF.
- Press-and-hold to turn OFF.

 +  **Program Features and Power Line Frequency**

While you press-and-hold , tap 

-  + : APD Auto-Power-Down  
 Battery conservation feature
  - Use  and  to select number of minutes (0FF to 90).
  - The Receiver will turn OFF after the specified number of minutes have passed with no key-press activity.
- Tap : BTM Backlight Brightness
  - Use  and  to set from 5% to 100%.
  - Ref: during operation, tap  to turn backlight  ON or OFF.
- Tap : Depth Display
  - When standing over a utility line, its depth is displayed.
  - Use  and  to toggle among the unit of measure selections:

	<u>Display for Depth reading</u>
999 "	inches only, always
1.00 m	meters
1' 0 "	feet and inches, always
36 "	inches up to 36", feet & inches deeper
48 "	inches up to 48", feet & inches deeper
60 "	inches up to 60", feet & inches deeper
72 "	inches up to 72", feet & inches deeper
84 "	inches up to 84", feet & inches deeper
96 "	inches up to 96", feet & inches deeper
- Tap : local powerline frequency
  - Use  and  to select 50Hz or 60Hz.
  - Factory default is 60Hz.

 **Volume**







- Use  and  to select speaker volume.
- From OFF to 100%.

**RECEIVER OPERATION - GET READY**

1. After the Transmitter is connected and energized, turn on the Receiver to set up and prepare to deploy.

2. Pick the transmit source:

**A. TW9000 Transmitter**

- i: Tap **m** until  appears.  
When  appears, subsequent taps on **m** will toggle through four locating modes:
  - a.  Peak & Null
  - b.  Wide Peak
  - c.  Narrow Peak
  - d.  Null
- ii: Tap **f** to toggle through the available frequencies to match the Transmitter's current operating frequency: 512Hz, 8kHz, 33kHz or 82kHz.

**B. Sonde**

- i: Tap **m** until  appears.
- ii: Then tap **f** to match the energized sonde's operating frequency: 512Hz, 8kHz, 33kHz or 82kHz.

**C. A Passive Power Source**

- i: Tap **m** until  appears.
- ii: Then tap **f** to toggle through and select the power source:

**LN** Power Line  
60Hz or 50Hz as previously programmed.  
Detects fundamental and odd-numbered harmonics (AC 1, 3, 5 & 7).

**CP** Cathodically Protected Pipe  
120Hz or 100Hz as previously programmed.  
Detects even-numbered harmonics.

**AC 1-7** Harmonic of Power Line Frequency

	if 60Hz	if 50Hz
AC 1	60	50
AC 2	120	100
AC 3	180	150
AC 4	240	200
AC 5	300	250
AC 6	360	300
AC 7	420	350

## DEPLOY THE RECEIVER

**Trace the Utility in DIRECT CONNECTION or INDUCTIVE Mode**

1. Select Frequency **f** and mode **m**.
2. In Inductive Mode, stand 30 feet (9 meters) away from the activated Transmitter.
3. Hold the Receiver with the flat side of the blade facing the Transmitter.
4. Walk in a circle around the Transmitter, with the blade always facing the Transmitter.
5. Audio and display-icon feedback will indicate when the operator approaches and stands over the utility.

### AUDIO

- Audio pitch increases as the Receiver approaches the utility.
- Audio pitch decreases as the Receiver moves away from the utility.
- When using Peak & Null **∞∞**.
  - hear a **BROKEN** tone to the **LEFT** of the utility.
  - hear a **CONTINUOUS** tone to the **RIGHT** of the utility.

## RECEIVER Display and Operation

### Signal Strength.

- Increases as operator approaches utility.
- LOW** = no signal

LOW to 1999

### Left/Right

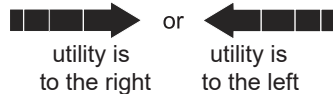

### Over-Target

- Operator is standing over the utility.
- Blade must be near perpendicular to the utility line to illuminate the (●) indicator.



### Azimuth (direction/orientation)

When in close proximity to the utility, the arrows indicate the direction of the utility line relative to the operator's position.

#### Operator action required:

1. Orient the blade to illuminate the center-most line ↓ so that the blade is perpendicular to the utility line.
2. Sweep the Receiver left-and-right to find the over-target ↓ location.

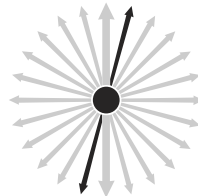

**RECEIVER Display and Operation (continued)**

**Signal Bar (using  mode)**

The empty segments represent the location of the utility in relation to the operator's position.





When using Peak & Null  mode, the signal bar is a left/right indicator presented as an angle-of-approach.

If no segments are illuminated, there is no signal -- continue searching.

When operating in Peak & Null  mode, Position of Receiver  
 Over-target.

 The utility is to the left of the operator.

 The utility is to the right of the operator.

**Signal Bar ( using , , ,  )**

The signal bar fills from left-to-right as signal strength increases.

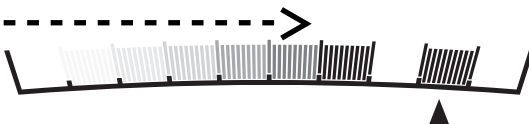

As the Receiver moves away from the utility, the maximum-signal level remains temporarily illuminated as the real-time signal strength decays to the left of the display.

The "sticky" push-bar segment is a visual reference of the maximum signal strength detected. The operator continues sweeping over ground to find the location with the strongest signal.

## RECEIVER Display and Operation (continued)

GAIN GAIN is continuously displayed when using or .

Using or , the operator must manage GAIN when the signal strength is very low or very high (indicating far-left or far-right of scale).

When the signal strength is near center-of-scale, presses of and cause SMALL GAIN ADJUSTMENTS to emphasize small changes in signal strength when moving the Receiver side-to-side.

When the operator presses or with the signal strength at either extreme (left=low or right=overload), GAIN is adjusted AUTOMATICALLY to bring the signal strength to the middle of the scale. This automatic gain adjustment saves the operator time.

The operator wants to hear and see *changes* in the signal when moving closer to, or farther from, the utility. When the signal reads too far right (overload) or left (weak signal) of scale, the operator cannot easily resolve changes in signal strength. To pinpoint the exact location of the utility, the operator repositions the Receiver in progressively smaller amounts while observing subtle changes in signal strength. The utility is located directly beneath the location where the signal strength is strongest.

After locating the utility's starting-point, the operator walks along the line, following the signal path.

In addition to the above-mentioned audio and visual indicators, the operator interprets CURRENT, GAIN and DEPTH values to continue to accurately identify the line's location while walking along the path of the utility.



Key

To measure CURRENT in or :

- Position Receiver over utility.
- Wait for the over-target ( ● ) indicator.
- Press-and-hold .

As the operator moves farther down the line, and signal strength degrades, the display values may appear jumpy and inconsistent.

- Press-and-hold to stabilize the display and obtain more accurate values.

REMEMBER TO:

- Only invoke when over-target ( ● ).
- Be patient. Hold for several seconds.
- Keep still. Hold the Receiver motionless while depressing .

**RECEIVER Display and Operation (continued)**



When using Peak & Null  $\infty$  and standing over the utility, the CURRENT is continually displayed, in milliamperes (mA), when a signal is detected. As the operator moves farther away from the Transmitter, the CURRENT degrades.

DEPTH



The utility's depth is displayed at bottom-right when the over-target ( ● ) icon is illuminated.

For the most accurate depth measurement, be over-target  $\ddagger$ ; then press-and-hold  $i$ .

Invoke  $i$  if display values appear jumpy and inconsistent.

The unit of measure for depth readings can be changed using  $m$  +  $\text{power}$  as explained in the programming instruction on page 18.

**! WARNING!** Do not rely on depth measurement for excavation. Operator skill and utility characteristics impact depth measurement accuracy. Always follow safe digging practices.

Calculate a utility's depth manually with simple trigonometry using  $\infty$

at 45°,  $X = d$

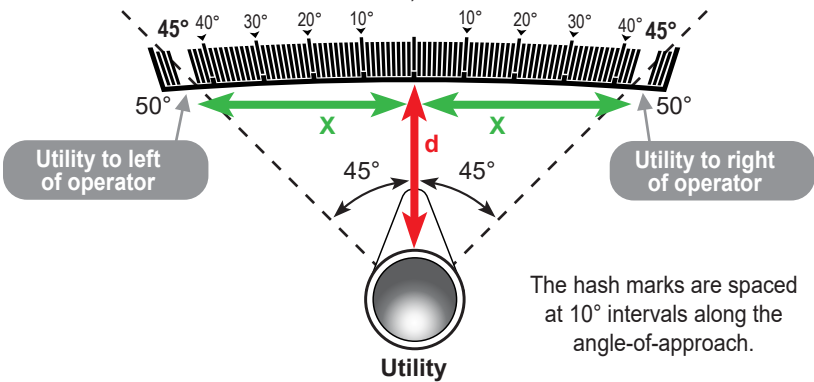

The hash marks are spaced at 10° intervals along the angle-of-approach.

**Reference:** with the signal bar indicator at either of the 45° positions, the depth of the utility ( $d$ ) is equal to the distance ( $X$ ) of the Receiver from the over-target ( ● ) location.

**Note:** the  $\leftarrow$  and  $\rightarrow$  keys are disabled in  $\infty$ ; gain is automatic.

## RECEIVER Display and Operation (continued)

To use the **PASSIVE POWER** mode:

1. Tap **m** until the ⚡ icon illuminates.
2. Tap **f** to toggle through and select the power source. See page 19 for summary of selections.
3. Press **f** to select Frequency.

Refer to page 19 for available frequencies:

LN	Power Line
CP	Cathodic Protection
AC 1 to 7	For advanced users

4. Deploy the Receiver.

Attention: utility must be energized with current flowing to trace power lines.

Proceed with the appropriate search pattern; signal source may be known or unknown.

Scenario #1: Source of signal is known.

- Walk in a circle around the signal source, with the blade always facing the source.
- Audio and display-icon feedback will indicate when the operator approaches and stands over the utility.

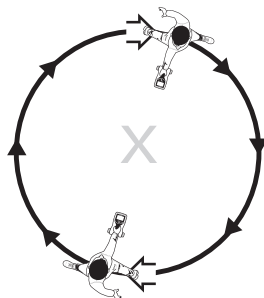

Scenario #2: Search for underground power line whose source and destination are unknown.

- Start with gain set at 50% or more.
- Survey the area in a grid pattern.

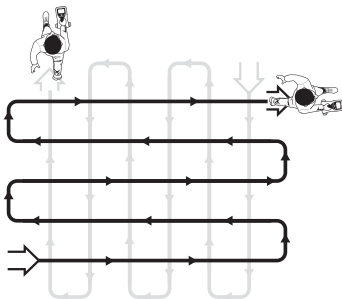

Attention: Very low current and deeply buried utilities may not be detectable, even at 100% gain.

**RECEIVER Display and Operation (continued)****Using PASSIVE POWER mode (continued)**

5. Use audio and display feedback to locate utility.

**AUDIO**

- Volume increases as the Receiver approaches the utility.
- Volume decreases as the Receiver moves away from the utility.

**SIGNAL STRENGTH.**

- Increases as operator approaches utility.

**LOW** = no signal

**LOW** to **1999**

**GAIN** (operates as described on page 22)

Note: There are no Over-Target, Azimuth, Current or Depth indicators in Passive Power mode.

The Signal Bar and Gain control operate as described on pages 21 (bottom) and 22.

**6. Interference Alerts**Overload

If gain is set too high and the conductor carries high current, use  to reduce the gain.

Overhead Signal

When a signal is detected above the operator that is stronger than any underground signal.

EXAMPLE: When tracing an underground utility close to an overhead power line.



**RECEIVER Display and Operation (continued)**

**To use the SONDE mode:**

1. Tap **m** until the  icon appears.
2. Tap **f** to select the operating frequency of the Sonde.
3. Power on the Sonde.
4. Verify that the Receiver detects the Sonde's signal.
5. Install the Sonde on a pushrod and push through pipe.  
Note: Pushrod not included in TW9000 package.
6. Walk along path of pipe with blade parallel to the pipe.
7. Find the peak signal.

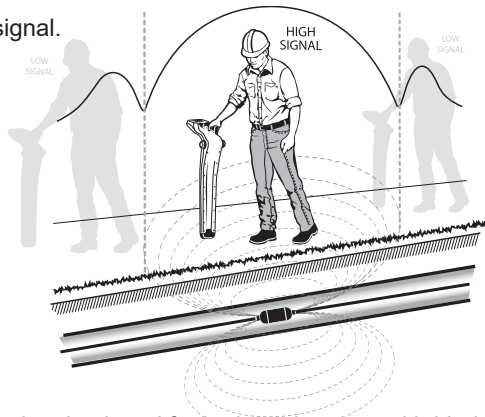



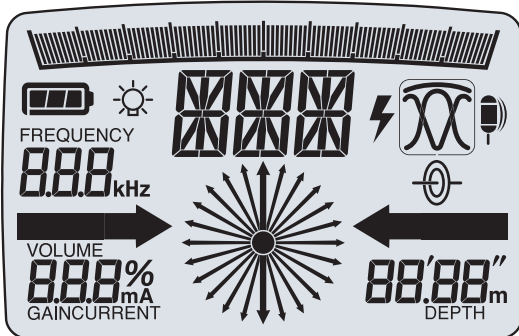



8. Then move Receiver back and forth along the pipe, with blade parallel to pipe, to pinpoint peak signal.
9. Refer to Left/Right and Azimuth icons. See page 45.
10. Over-Target (●) icon indicates that operator is aligned with the Sonde.





Receiver display - all segments









**RECEIVER Keypad Controls**

Key	Description
	<b>Power/Backlight Key.</b> A long key-press turns the unit on or off. A short key-press turns the backlight on or off.
	<b>Frequency Key.</b> Sets the operating frequency to 512 Hz, 8 kHz, 33 kHz or 82 kHz. Cycles through each frequency with successive key-presses. Remembers last setting.
	<b>Volume Key.</b> Enables ◀ and ▶ to change speaker volume.
	<b>Mode Key.</b> Select one of six detecting modes: Peak & Null, Wide Peak, Narrow Peak, Null, Sonde or Passive Power.
	<b>Minus/Plus Keys.</b> Change gain or speaker volume in Null, Wide Peak, Narrow Peak and Passive Power modes.
	<b>Measure Key.</b> Measure depth and current of buried utility or Sonde. Press-and-hold, with Receiver motionless, for most precise depth and current measurements.







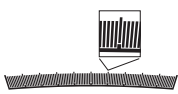

**RECEIVER Display Icons**

Icon	Description
	<b>Battery Status.</b> Indicates the battery charge level in bars. When the battery is near complete-discharge, no segment illuminates and the battery outline flashes.  NOTE: If the outline flashes <u>while the segments are illuminated</u> , the ADAPTOR has malfunctioned; see page 49.
	<b>Backlight Status.</b> Illuminates when the backlight is on.
	Tracing a utility line using a signal generated inside the Transmitter, either Direct Connection or Inductive.

**RECEIVER Display Icons (continued)**

Icon	Description
	<p><b>Peak &amp; Null mode indicator.</b></p> <ul style="list-style-type: none"> <li>• Automatic mode.</li> <li>• Easiest to use.</li> </ul>
	<p><b>Wide Peak mode indicator.</b></p> <ul style="list-style-type: none"> <li>• For hard to detect utilities.</li> <li>• Wide area; high sensitivity.</li> </ul>
	<p><b>Narrow Peak mode indicator.</b></p> <ul style="list-style-type: none"> <li>• For congested utilities.</li> <li>• Narrow detection pattern.</li> </ul>
	<p><b>Null mode indicator.</b></p> <ul style="list-style-type: none"> <li>• Compare result of Null mode with other modes' results.</li> <li>• Indicates utility's signal roundness (lack of shape distortion).</li> </ul>
	<p><b>Sonde mode indicator.</b></p>
	<p><b>Passive Power mode indicator.</b></p>
	<p><b>Left/Right Direction Arrows:</b> In Peak &amp; Null mode, the arrows indicate which side of the utility the Receiver is on, pointing toward the direction of the utility's actual location. A short arrow indicates short distances, and a long arrow indicates longer distances. The arrows disappear when the Receiver is directly over the utility.</p>
	<p><b>Azimuth Direction Arrows:</b> The Azimuth arrows point in the direction that the utility runs.</p> <p><b>Over-Target Indicator:</b> The center circle illuminates when the Receiver is directly over the utility.</p>
	<p><b>Signal Strength Reading:</b> Displays the strength of the detected utility's signal, from 0 – 1999.</p>

**RECEIVER Display Icons (continued)**

Icon	Description
	<p><b>Signal Bars:</b> Graphically indicates the strength of the detected utility's signal by the number of bars displayed. A "push bar" feature is included that briefly holds the previously displayed peak bar for reference.</p>
<p>FREQUENCY</p> 	<p><b>Frequency Setting:</b> Displays the selected operating frequency.</p>
<p>DEPTH</p> 	<p><b>Depth Measurement:</b> See page 18 for unit of measure programming.</p>
	<p><b>Current Measurement</b></p>
<p>GAIN</p> 	<p><b>Manual Gain Setting:</b> Displays the Gain setting as a percentage when adjusted using ◀ and ▶.</p>
<p>VOLUME</p> 	<p><b>Volume Setting:</b> Displays the % Volume Setting when adjusted using ◀ and ▶.</p>
	<p><b>Overhead Signal:</b> When a signal is detected above the operator that is stronger than any underground signal.</p>
	<p><b>Overload:</b> If gain is set too high and the conductor carries high current, use ◀ to reduce the gain.</p>

## UTILITY LOCATING BASICS

### METHOD OF DETECTION

The TW9000 employs the electromagnetic method of underground utility detection. With this detection method, a power source causes AC electrical currents to flow through the circuit paths formed by a buried conductive utility line or tracer wire and the return paths of the surrounding soil. The AC currents flowing through the line generate magnetic fields around the utility line that can be detected above ground by magnetic sensors in the TW9000 Receiver. The signals received by the TW9000 sensors are processed electronically, then presented to the operator audibly and visually.

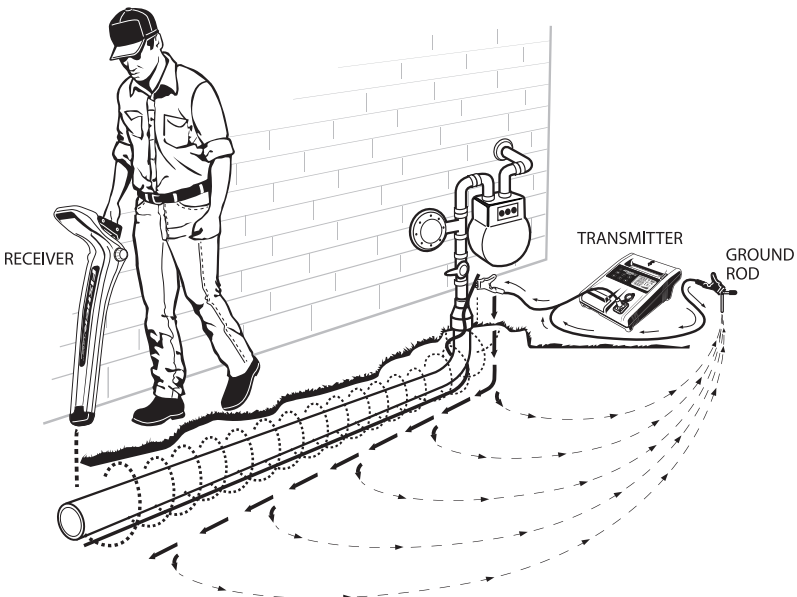

Figure 7. Utility Line Detection Method

### POWER SOURCES

Power sources are divided into two types: active and passive.

Active power is a controlled source that is actively and intentionally applied to the utility line by the TW9000 Transmitter. Active power sources are preferable as the operator can control its attributes (output power, frequency, coupling, etc.) to optimize utility tracing.

Passive power sources are uncontrolled, originating from the emissions of power lines and other electromagnetic radiators in the environment, not from the TW9000 Transmitter.

---

## **CIRCUIT PATH CHARACTERISTICS**

The electrical characteristics of the circuit formed by the transmitting power source, utility and ground-return have a direct impact on the quality of the signal the operator uses to trace the utility. The operator who is aware of the environmental factors influencing the underground magnetic fields can optimize locating results by selecting the most appropriate modes and frequencies, and controlling the amount of current applied.

### **Frequency**

Higher frequencies are recommended for shorter tracing distances, while lower frequencies are recommended for longer tracing distances. Due to distributed capacitance along the utility, higher frequencies can cause the energizing current to “bleed off” of the utility line closer to the power source, limiting the amount of current available for long-distance tracing.

Lower frequencies are recommended in congested areas. Lower frequencies are less likely to couple the signal into other nearby utilities and metallic objects. Signals that couple onto nearby infrastructure produce false secondary magnetic fields that interfere with the target utility’s magnetic field and may confuse the operator.

Higher frequencies may aid conduction when a utility line has insulated joints, as higher frequencies cause the current to pass through an insulator’s capacitance along the utility more readily than lower frequencies.

### **Return Paths**

Good return paths are required to maximize current flow along a utility. Utilities lacking a direct connection to ground generally result in weaker current flow. Without a direct connection, a higher frequency or the strategic placement of jumper wires to ground may improve conduction.

Poor soil conductivity degrades current flow. Dry, sandy soil conducts less current than wet and/or highly mineralized soil.

### **Multiple Circuit Paths**

Multiple circuit paths, such as laterals feeding off of a main line, divert energizing currents. This limits the amount of current available for long-distance tracing.

Secondary circuit paths supplied by a main path may have weaker current flow and may be too weak to trace. In such cases, it may be necessary to relocate the power source connection to a location that facilitates better current flow.

## MAGNETIC FIELD SHAPES AND DISTORTION

Under ideal conditions, an energized buried utility generates a concentric magnetic field around itself. See Figure 8 below. Due to the simple geometry of this concentric field, the utility locating system can very precisely communicate the location, direction and depth of the buried utility.

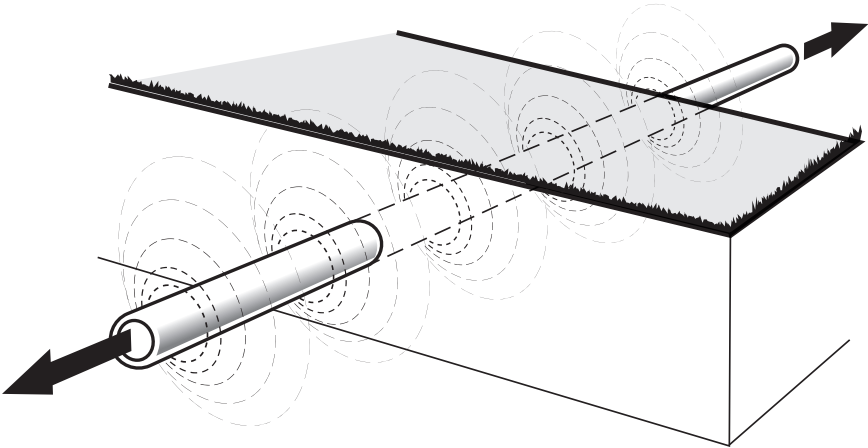

Figure 8. Ideal Magnetic Field Shape

Under less than ideal conditions, the magnetic field diverges from the ideal concentric shape, making it more difficult to interpret the TW9000's output and accurately locate a utility. See Figure 9 below.

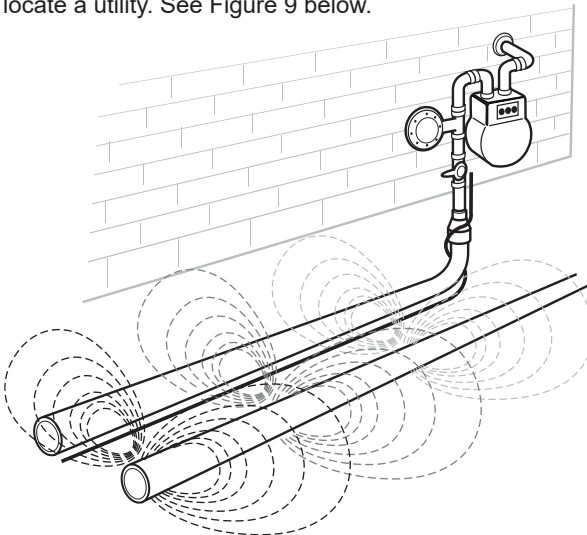



Figure 9. Distorted Magnetic Field Shape

Some causes of a distorted magnetic field include:

- Crooked and multiple circuit paths
- Interference from signals coupled into nearby utilities or large metallic objects
- Ground returns

When tracing any utility, best practice is to compare the “Peak” and “Null” signals. When the “Peak” and “Null” readings indicate the same location, the operator can be highly confident in marking the utility’s correct location.

The Null  mode provides the “Null;” the Narrow Peak  mode provides the “Peak.”

Differences in “Peak” and “Null” location readings are an indication of a distorted magnetic field and/or the presence of multiple, perhaps intercepting, utilities.

When the “Peak” location differs from the “Null,” further investigation is warranted; the operator should repeat the trace using different frequencies and/or changing other search parameters.

## UTILITY SEARCH TECHNIQUES

The first step in underground utility locating is to determine a starting point. Use prior knowledge of the approximate utility location, review utility maps, and examine any exposed portion of the utility to help locate this starting point. Once a starting point has been located, the operator can select the appropriate operating mode and then adjust the Receiver’s settings accordingly.

When the location of the utility cannot be determined, a wide scan of the area may be required. This can be accomplished by performing a “grid search” over the area. See Figure 10 below.

To ensure complete coverage of the area during a grid search, map out a grid of intersecting lines covering the search area and walk the grid at intersecting right-angles. Utility lines are detected when the user passes over the utility line with the blade of the Receiver held perpendicular (not parallel) to the utility.

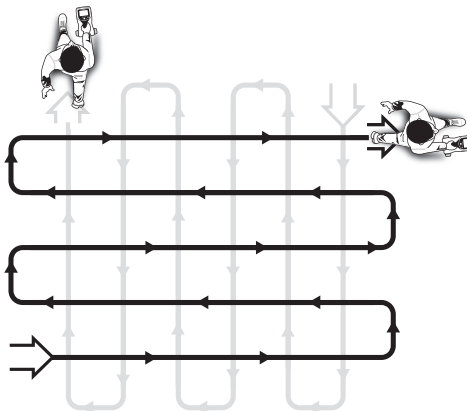

Figure 10. Conducting a Grid Search



## USING THE TRANSMITTER

For active tracing, the TW9000 Transmitter must be safely and properly connected to a non-energized target utility. Then, the optimal frequency and power output settings must be selected. There are three methods of utility connection:

- Direct Connection
- Coupling Clamp Connection
- Inductive Connection

Note: When using the TW9000 Transmitter for the first time, the Li-ion battery must first be activated by inserting the battery into the charger cradle, with power applied. See page 51.

### DIRECT CONNECTION mode

Direct Connection is the preferred method as it transfers the most power to a utility. This method requires the following components:

- TW9000 Transmitter
- Conductive Tracing Cables
- Ground-Rod

**⚠ WARNING!** Do not handle output leads unless power is OFF.

**⚠ ELECTRIC SHOCK HAZARD!** Servicing to be performed by qualified personnel only.

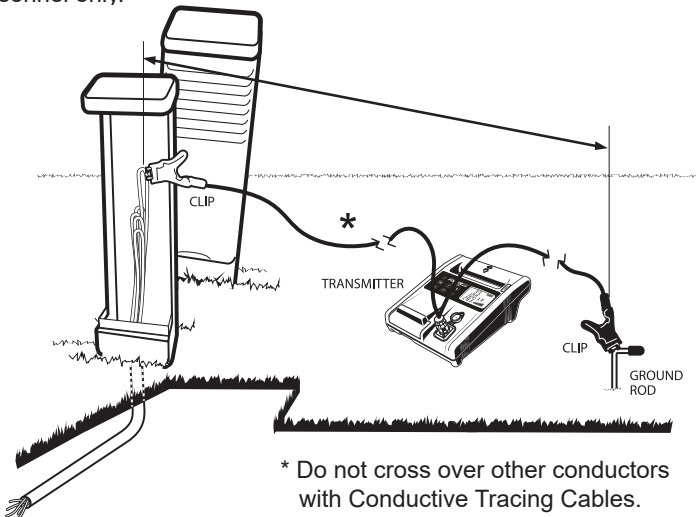









Figure 11. Direct Connection

**Direct Connection mode (continued)**

 **WARNING**  Never connect directly to live conductors. This equipment for use by professionally trained and fully qualified personnel only.

**To Operate with Direct Connection:**

- STEP 1.** Verify that the line you are connecting to is not energized.
- STEP 2.** Make sure the Transmitter is powered OFF.
- STEP 3.** Lift up the protective cap on the accessory jack and plug in the Conductive Tracing Cables.
- STEP 4.** Push the Ground Rod into the soil at a 90° angle to the direction of the utility. Do not cross over other conductors with Conductive Tracing Cables. See Figure 11 on page 34.
- STEP 5.** Firmly connect the black conductive tracing lead to the Ground Rod.
- STEP 6.** Firmly connect the **red** conductive tracing lead to an exposed bare-metal location on the non-energized utility.
- STEP 7.** Turn on the Transmitter and view the status indicators on the LCD display.
- STEP 8.** Using the  and  keys, select the desired operating frequency and type of output measurement to display.
- STEP 9.** Using the ,  and , adjust the output level and indicator volume to desired levels.

**Improving Direct Connection:**

Poor connection to the conductive tracing leads and/or Ground Rod can often lead to weak power transfer from the Transmitter to the utility, as indicated by the output measurement readings. The following guidelines are recommended to improve the connection:

- STEP 1.** Verify that the accessory jack on the Transmitter is free of debris. Clean as needed.
- STEP 2.** Verify that the Conductive Tracing Cable is securely plugged into the accessory jack on the Transmitter.
- STEP 3.** Verify that the conductive tracing leads are free of dirt or debris that would impair the connection. Clean the leads accordingly.
- STEP 4.** Verify that the red and black conductive tracing leads are firmly attached to bare metal on the utility and to the Ground Rod. If rust or debris is present, brush off and/or clean accordingly.
- STEP 5.** With the Transmitter connected and powered on, gently rotate the Ground Rod more securely into the soil.
- ALSO** Pouring water around the Ground Rod will decrease soil resistance, improving the return path.

**COUPLING CLAMP mode**

In some cases, a direct bare-metal connection to a utility may be unavailable, or it may be necessary to isolate the power transferred to a single line among a close grouping of lines. In these situations, a Coupling Clamp can be used to transfer power inductively from the Transmitter to the utility, without direct connection.

For this method to work effectively, the utility should be grounded at both ends to provide a good electrical circuit path. If adequate grounding is not provided, it may be necessary to add jumpers to ground at strategic locations to improve conductivity. See Figure 12 below. Insulated utilities may have enough stray capacitance to couple the signal to ground, but are generally weaker.

For distant clamping points that are difficult to access, an extension pole and cord are recommended for use with the Coupling Clamp. The Coupling Clamp is fitted with female threading (1/4" - 20) for attachment to an extension pole and provides a hook for cable attachment.

This method requires the following components:

- TW9000 Transmitter
- Coupling Clamp

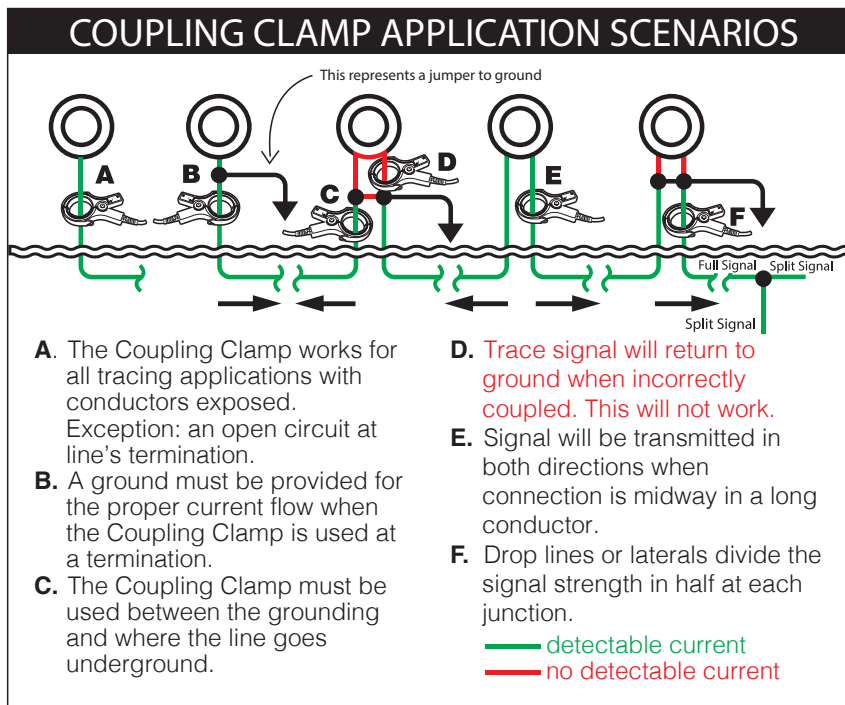







Figure 12. Coupling Clamp Scenarios

 **WARNING!** Do not clamp around live (energized) UNINSULATED conductors.

Note: While Transmitter output level settings are displayed graphically on the LCD, output measurement readings using  are unavailable in the Coupling Clamp mode.

### To use the Coupling Clamp connection:

- STEP 1.** Verify that the Transmitter is powered OFF.
- STEP 2.** Lift up the protective cap on the accessory jack and plug in the Coupling Clamp.
- STEP 3.** Locate a clamping point on an exposed part of the utility that is below and between ground connections to provide a good electrical circuit path, as mentioned above. See Figure 12 on page 36.
- STEP 4.** Open the Coupling Clamp jaws and clamp around the utility at the location determined in Step 3. Verify that the jaws make secure contact with each other when the clamp is closed.
- STEP 5.** Turn the Transmitter on and view the status indicators on the display.
- STEP 6.** Press  to select the desired operating frequency.
- STEP 7.** Press  and  to adjust the output level as desired.

### Improving Coupling Clamp connection:

The following guidelines are recommended to improve power transfer from the Coupling Clamp to the utility.

- STEP 1.** Verify that the Coupling Clamp jaws make a secure contact with each other when the clamp is closed. Clean off any debris from the contacts.
- STEP 2.** Make sure the accessory jack on the Transmitter is free of debris. Clean as needed.
- STEP 3.** Verify that the Coupling Clamp is securely plugged into the accessory jack on the Transmitter.
- STEP 4.** Locate a strategic point on an exposed part of the utility to insert a jumper wire to ground. See Figure 12 on page 36.
- STEP 5.** For insulated utilities with poor grounding, use a higher transmit frequency.

## INDUCTIVE mode

In some cases, there will be no direct connection or clamping locations on a utility. In these situations, the TW9000 Transmitter provides an Inductive mode to transfer power to the utility without making direct contact. Inductive mode is the default mode of connection when nothing is plugged into the Transmitter's accessory jack.

Inductive mode is the least preferred method of connection, as it is least efficient in transferring power to a target utility. Another challenge when using the Inductive mode is the presence of unwanted secondary magnetic fields. The Transmitter's inductive energy may unintentionally couple onto adjacent utilities and nearby conductive objects. The magnetic fields from these secondary sources may be difficult to distinguish from your target utility's magnetic field.



Keep large metallic objects away from the Transmitter handle when using the inductive mode. The energizing field is generated inside the handle of the Transmitter. A large metal object near the Transmitter handle will cause the Transmitter to “overload.” In response to an overload condition, the Transmitter automatically lowers the power to a safe level and alerts the operator (with audio indicator and flashing overload symbol) to move the Transmitter to an alternate location.

### Notes:

- In Inductive mode, power, voltage, current and resistance measurement are not available. See icon explanations on pages 16-17.
- Selectable operating frequencies are limited to 8 kHz and above.

### To operate in Inductive Mode:

**STEP 1.** Verify that the Transmitter is powered OFF.

**STEP 2.** Make an initial determination of the location and direction of the buried utility. Prior knowledge of the utility or some exposed portions of the utility can be helpful.

**Inductive Mode operation (continued)**

**STEP 3.** Place the Transmitter over the assumed location of the utility and align it so that the Utility Direction Arrow on the Transmitter handle is pointing in the direction of the utility.

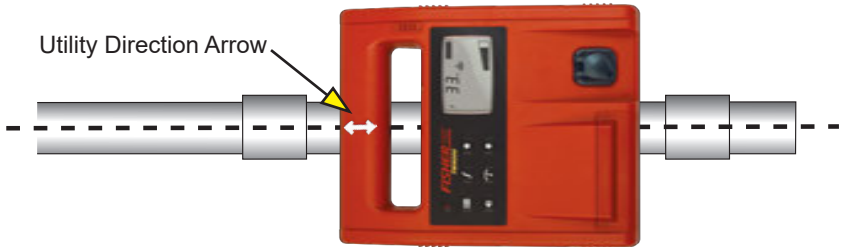

Figure 13. Inductive Coupling Tracing Alignment

**STEP 4.** Verify that the Transmitter is not placed over or near large metal objects, such as manhole covers or sheet metal.

**STEP 5.** Turn on the Transmitter and view the status indicators on the display.

**STEP 6.** Use the **f** key to select the desired operating frequency.

**STEP 7.** Use **▲** and **▼** to adjust the output level as desired.

**Improving Inductive Coupling**

The following guidelines are recommended to improve inductive power transfer from the Transmitter to the target utility.

**STEP 1.** If the utility direction is unknown, place the Transmitter on the ground and turn it on. Use the Receiver to make a radial sweep at least 30-ft (9-m) away from the Transmitter until a signal is detected. While noting the signal strength on the Receiver:

- 1a.** Rotate the Transmitter until the signal strength reading on the Receiver peaks.
- 1b.** Move the Transmitter in a direction perpendicular to the Utility Direction Arrow on the handle until the signal strength peaks on the Receiver.

See Figure 14 on page 40.

**STEP 2.** Select a higher operating frequency for better inductive coupling. Beware that higher frequencies may couple more readily to unintended adjacent utilities and metal objects.

## Improving Inductive Coupling (continued)



Figure 14. Improving Inductive Coupling

## USING THE RECEIVER

The TW9000 Receiver has a variety of operating modes and adjustable settings to help you optimize performance across environmental conditions and locating scenarios. For best results, familiarize yourself with each mode of operation.

## RECEIVER Operating Modes

Each press of **m** cycles through each of the six operating modes. Each mode configures the TW9000 to process and respond in a specific way for different approaches to tracing the line.

### Peak & Null mode

The Peak & Null mode is the easiest “turn-on-and-go” mode for most active tracing situations.

In this mode, the Receiver gain is continuously and automatically adjusted for peak audio pitch when directly over a utility. When the lateral distance from the utility is beyond a 45° triangulation window, the audio responds to a detected field with a fixed low pitch tone. When the Receiver approaches the utility within this 45° triangulation window, the pitch increases and peaks when directly over the target. The audio tone is constant when the Receiver is left of the utility, and the tone is pulsed when to the right. See Figure 15 on page 41.

**RECEIVER Operating Modes (continued)**

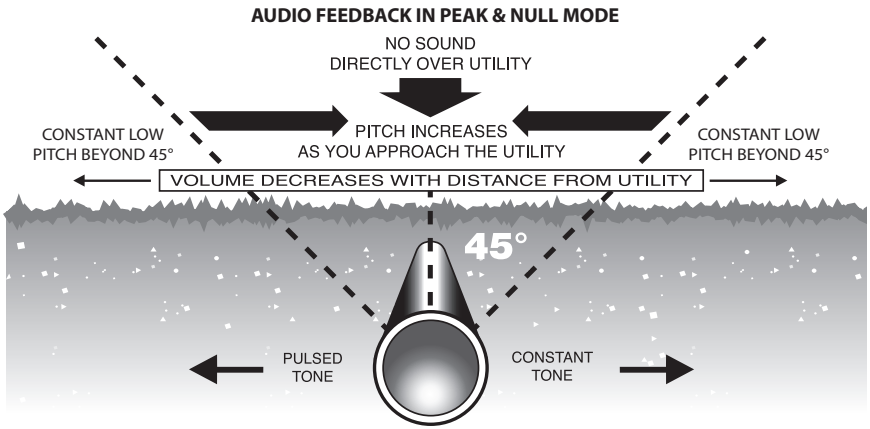





Figure 15. Pitch Triangulation

During utility tracing, the LCD displays a signal strength reading with corresponding bar graph indication. Left and Right arrows indicate the location of the utility in relation to the operator's position. Azimuth arrows indicate the direction and orientation of the utility. When the Receiver is directly over a utility, the Left/Right arrows disappear and the Over-Target indicator is displayed, along with depth and current measurements.

**Wide Peak mode** 

The Wide Peak mode is useful for detecting utilities from far lateral distances, or utilities that are deeply buried in a search area with little to no interference caused by other nearby utilities. In this mode, the Receiver's signal strength reading and audio respond to the wider field response sensed by the Receiver's lower horizontal magnetic sensor. Peak signal strength and audio pitch indicate the location of the utility. See Figure 16 on page 43.

When tracing in this mode, the manual gain must be periodically adjusted in order to resolve the location and direction of the utility. Press  to increase the gain for weak signals and  to decrease the gain for stronger signals. When the utility is close, try to adjust the gain to a level where a peak signal strength reading can be determined.

To measure current, first identify the location where a peak response occurs. Next, lower the sensing blade of the Receiver directly onto the ground and press . After a few seconds, the current measurement will display on the LCD. The previous operation will resume after release of .



## RECEIVER operating modes (continued)

### Narrow Peak mode



Narrow Peak mode is useful when tracing in areas congested with other utilities. Although less sensitive than the Wide Peak mode, it is better at distinguishing among multiple target utilities and nearby interfering objects.



The Narrow Peak mode is similar to Wide Peak mode, differing only in its use of a differential sensor configuration. See Figure 16 on page 43.

### Null mode

The Null mode is useful for determining the location of buried utilities having low field-shape distortion. In this mode, the Receiver's signal strength reading, audio, and Left/Right/Over-Target indicators respond to the sharp, localized "null" response provided by the Receiver's vertical magnetic sensor. At detectable distances from the utility, the signal strength, directional arrows and audio begin to detect and indicate the utility's magnetic field. When the Receiver is directly over the utility, the signal strength reading drops close to zero, audio goes silent, the Left/Right arrows disappear, and the Over-Target indicator is displayed. See Figure 16 on page 43.

When tracing utilities in areas plagued with multiple and/or intersecting lines and field shape distortion, compare the Over-Target locations indicated by the Null mode and Peak mode(s) against each other to gauge the severity of the field shape distortion. In most cases, Peak mode results are more accurate than Null mode results. See page 32 for more information.

As in the Peak modes, the operator must periodically adjust the gain manually in order to resolve the location and direction of the utility. Press  to increase the gain for weak signals, and  to decrease gain for stronger signals. When the utility is close, try to adjust the gain to a level where a null signal strength reading can be achieved.

To measure current, first identify the location where a peak response occurs. Next, lower the sensing blade of the Receiver directly onto the ground and press . After a few seconds, the current measurement will display on the LCD. The previous operation will resume after release of .

**RECEIVER operating modes (continued)**

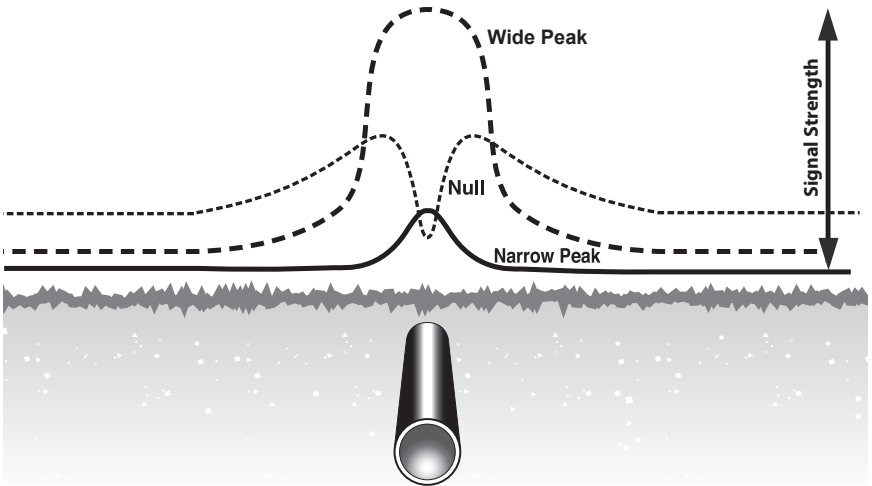







Figure 16. Peak and Null Modes

**Sonde mode** 

The Sonde mode operates in conjunction with an auxiliary Sonde probe that is inserted into the utility line. Sondes are typically mounted to inspection cameras or other feeding devices to trace pipes and sewers, and locate blockages. 512Hz is the most common Sonde transmit frequency; 8kHz, 33kHz and 82kHz are also available. This mode operates similar to the Wide Peak mode but employs the Left/Right/Azimuth/Over-Target directional indicators for added information. As in Wide Peak mode:

- The Receiver's signal strength readings and audio respond to the field sensed by the lower horizontal magnetic sensor.
- The gain must be periodically adjusted in order to resolve the location and direction of the utility. Press  to increase the gain for weak signals, and  to decrease the gain for stronger signals.
- Depth measurement illuminates when over-target ().



**To Operate in Sonde Mode** :

- STEP 1.** Insert a new battery into the Sonde, verifying that the Sonde is turned on and tightly sealed after battery installation.
- STEP 2.** Mount the Sonde onto your feeding device, and insert it into the pipe.
- STEP 3.** Press  to turn the Receiver on.
- STEP 4.** Press  to select Sonde mode.
- STEP 5.** Press  to select the transmit frequency of the Sonde.

**RECEIVER operating modes (continued)****Sonde mode Operation (continued)**



**STEP 6.** Properly align the Receiver to the direction of the Sonde. See Figure 17 on page 45.

- 6a.** Lower the Receiver's sensing blade to the ground and position it with the wide section of the blade parallel to the pipe (handle perpendicular to pipe).
- 6b.** When the Receiver blade is properly aligned, the Azimuth arrows point horizontally and the signal strength reading displays a peak.
- 6c.** With the Receiver blade properly aligned, move the Receiver laterally over the pipe until a peak signal strength reading is observed.

**STEP 7.** Using  and , adjust the gain of the Receiver to a level where a peak signal strength reading can be determined.

**STEP 8.** Determine the location of the Sonde. See Figure 18 on page 45.

- 8a.** As you trace along the direction of the pipe over the Sonde, you will encounter three peak signal strength and audio responses: two minor peaks at both ends of the Sonde and one major peak directly over the top of the Sonde. Between any of the minor peaks and the major peak, you will encounter null responses.
- 8b.** Approaching the major peak of the Sonde from the left or right causes the respective Left or Right arrow indicators to display, and both the signal strength reading and audio pitch will increase.
- 8c.** When you are directly over the Sonde, the Left/Right arrow indicators will disappear, the Over-Target indicator will display, and both the signal strength reading and audio will peak.

**STEP 9.** When over-target () , the Sonde's depth is displayed. For the most accurate depth measurement, lower the Receiver's sensing blade to the ground (where the Sonde's location has been determined) and press  . After a few seconds, the current measurement will also be displayed. The previous operation will resume upon release of  .

**RECEIVER operating modes (continued)**

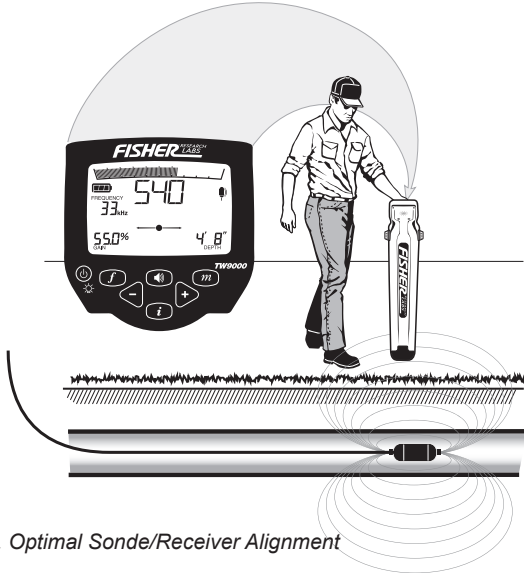

Figure 17. Optimal Sonde/Receiver Alignment

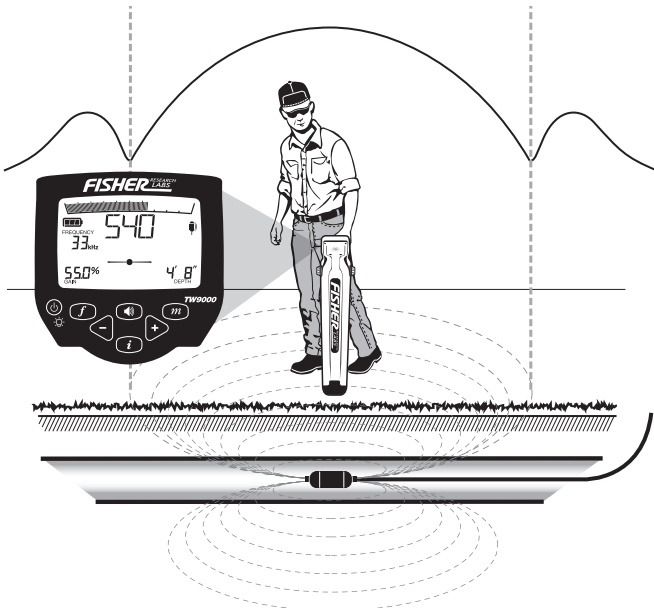



Figure 18. Sonde Signal Strength Response

## RECEIVER operating modes (continued)

### Passive Power Mode

 **WARNING!** Use extreme caution when working near powerline utilities.



The Passive Power mode is used to trace buried utilities that are energized by AC power currents, not by the TW9000 Transmitter. The Receiver detects the magnetic fields generated by these power currents at their fundamental powerline frequency and associated harmonics. The Receiver can be programmed to detect either 50Hz or 60Hz powerline frequencies.

Use  +  to select 50Hz or 60Hz powerline frequencies (see page 18).

In Passive Power mode, operation begins at the fundamental and odd-numbered powerline frequency (50Hz or 60Hz), indicated by *L<sub>1</sub>n*. The operator can use  to select any one of 7 harmonics displayed as *AC 1* through *AC 7*.

To detect cathodically protected pipe at 120Hz or 100Hz, select *CP*.

See page 19 bottom to program *AC* or *CP* selections.

The operator must periodically adjust the gain in order to resolve the location and direction of the utility. Press  to increase the gain for weak signals, and  to decrease gain for stronger signals.

Notes:

- The depth and current measurements as well as the Left/Right/Azimuth/Over-Target indicators are inactive in Passive Power mode.
- The current must be flowing in the buried utility in order for the Receiver to detect the associated magnetic field. Live buried power lines, not under load, may be present but undetectable without current flowing.

## REPLACING THE RECEIVER BATTERIES

The TW9000 Receiver is powered by the rechargeable battery provided, or as a back-up, by two D-cell alkaline batteries.



Figure 19. Receiver Battery Replacement

- STEP 1.** Locate the battery cap on the right side of the unit.
- STEP 2.** Twist the battery cap counterclockwise to remove it.
- STEP 3.** *For D-cell batteries:* Insert batteries, positive terminals facing outward.
- For rechargeable battery:*
- A.** Insert 26650 battery into adaptor (+ outward).
  - B.** Insert adaptor-with-battery, (battery +) facing outward.
- STEP 4.** Twist the battery cap clockwise until secure.
- STEP 5.** Turn power on.

**WARNING!** Use only D-cell alkaline or the Fisher Labs 26650 Li-Ion battery to power Receiver.

## RECEIVER RECHARGEABLE BATTERY KIT

The standard 26650 Lithium-Ion battery provides more than double the operating time of two D-cell alkaline batteries. (D-cell battery capability is available as a backup.)

The Receiver Rechargeable Battery Kit includes:

1. One 26650 Lithium-Ion Battery.
2. Battery Holder/Adaptor (this holds the 26650 battery for insertion into the Receiver).
3. Charger with LCD display (Charger holds two batteries; this Kit includes only one battery).
4. USB Cable (USB-A to USB-C).
5. AC Power Adaptor.

**Note:** To charge the battery through an automobile cigarette lighter port, a user may connect his own 3rd party cigarette-lighter-adaptor-with-USB-C (not supplied) to the Charger.

### Important instruction and caution:

1. The Lithium-Ion Battery is shipped in a plastic box and should be fully charged before first use.
2. Read the instructions provided with the Charger for important safety and maintenance information.



Figure 20. Receiver Rechargeable Battery Kit

**RECHARGING THE RECEIVER BATTERY**

- STEP 1.** Remove the discharged battery from the tube-shaped Battery Holder/Adaptor.
- STEP 2.** Attach the USB cable to the AC Power Adaptor (or other user-provided power adaptor) and connect to the Charger.
- STEP 3.** Connect the Power Adaptor to an appropriate power source.
- STEP 4.** Place the battery in the Charger.
- STEP 5.** The display on the Charger displays charging current and other battery measurements.
- STEP 6.** Leave the battery inserted until the Charger's indicator turns **green**, indicating the battery is fully charged.
- STEP 7.** Remove the battery for use.

Indicator	Description
<b>Green Light</b>	Standby/fully charged.
<b>Red Light</b>	Self-Examining/Charging/Activating.
<b>No Light</b>	Power Supply Disconnected.



**CAUTION: Malfunction Warning on the TW9000 Receiver**

If the rechargeable Lithium-Ion battery is installed and the ADAPTOR has been tampered with or is damaged, the outline of the battery indicator will flash while all battery segments are illuminated. This condition is not a low-battery indication.

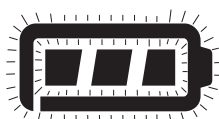



## REPLACING THE TRANSMITTER BATTERY

The TW9000 Transmitter is powered by a rechargeable 14.4 volt Lithium-Ion battery located in a sealed compartment.

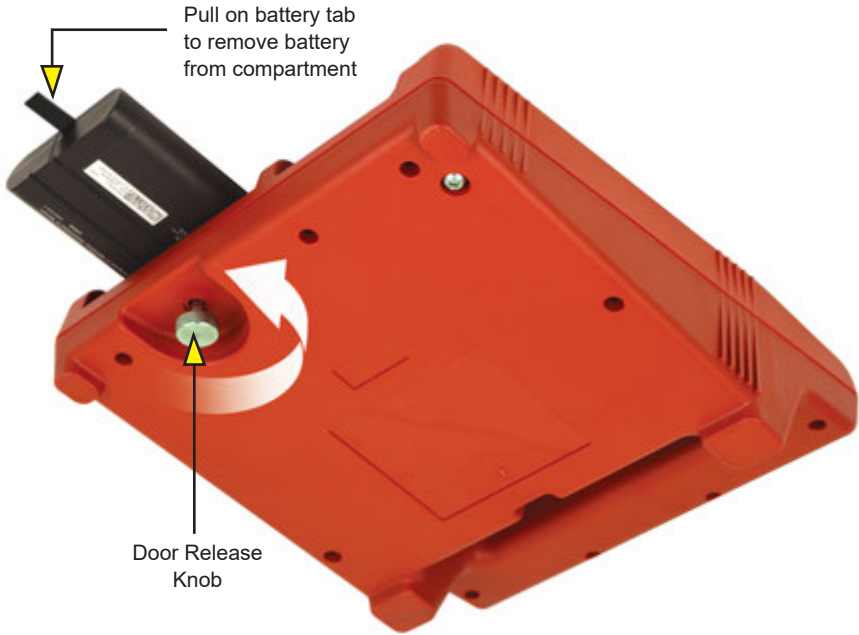

Figure 21. Transmitter Battery Replacement

- STEP 1.** Locate the Door Release Knob on the bottom of the Transmitter.
- STEP 2.** Twist the Door Release Knob counterclockwise until the battery cover on top of the unit detaches.
- STEP 3.** Locate the plastic pull-tab at the top of the battery.
- STEP 4.** Grasp the pull-tab and pull the battery out.
- STEP 5.** After charging, reinsert the battery with the pull-tab positioned at the top.
- STEP 6.** Align the battery cover over the battery compartment.
- STEP 7.** Tighten the Door Release Knob, making sure the battery cover is fully seated and tight against the battery compartment.

## RECHARGING THE TRANSMITTER BATTERY

The Transmitter battery fits into a cradle for charging, as illustrated below.

The Lithium-Ion battery must be charged before its first use.

For additional safety and maintenance information, refer to the instructions provided with the charger.



Figure 22. Battery and Charging Components

- STEP 1.** Select the appropriate power adapter (A/C or automobile).
- STEP 2.** Connect the cable from the Power Adapter to the Cradle.
- STEP 3.** Connect the Power Adapter to a power outlet (A/C or cigarette lighter).
- STEP 4.** Refer to the Status Indicator Light to verify that the brief **red/orange/green** self-test completes, indicating that the charger is ready for use.
- STEP 5.** Place the discharged battery into the Cradle and monitor its charge on the Status Indicator Light.
- STEP 6.** Leave the battery inserted until the Status Indicator Light turns **green**.
- STEP 7.** Charged battery is ready for use.

**RECHARGING THE TRANSMITTER BATTERY (continued)**

LED Indication	Description
One-time Red/Orange/Green Light	The self-test is complete. The charger is ready for use.
Red/Green Blinking	The battery is not recognized. If the battery is extremely discharged, it will reactivate and start charging within 15 minutes.
Orange Light	The battery is charging.
Green Light	The battery is fully charged and ready for use.
Red Blinking	The battery is too hot or too cold. Before charging, allow a hot battery to cool off, or allow a cold battery to warm up.
Red Light	The battery is damaged and must be replaced, or the battery is not rechargeable.

 **WARNING!** Use only the rechargeable 14.4 volt Li-Ion battery supplied by Fisher Research Labs to power the Transmitter.

**U.S.A. INDUSTRY LINKS**

**Nulca**

**Underground Utility Locating Professionals**

Formerly known as the National Utility Locating Contractors Association, now “Nulca – representing utility locating professionals”. Nulca was formed in 1994 by several contract locating companies to advance utility locating throughout North America. In 1996, Nulca published its first Competency Standard for training utility locators. This guideline has since become the industry standard and is now in its fifth revision. It serves as the basis for the Nulca Accreditation/Certification program, rolled out in March 2016 through a partnership with NSF, the industry leader in safety-based risk management solutions and verification.

Nulca also works closely with numerous industry associations and organizations to prevent utility damage as well as to promote safety and enhance communication. Nulca works to promote professional locating from the individual technician to the largest company. Nulca members include contract locators, in-house locators, pipeline companies, private locators, SUE contractors, vacuum excavators, regulators, one call systems, manufacturers, suppliers and many others.

**CGA**

**Common Ground Alliance**

Dedicated to preventing damage to underground utility infrastructure and protecting those who live and work near these important assets.

**SPECIFICATIONS AND COMPLIANCE**

Item	Description	Specification
<b>1</b>	<b>Environmental</b>	
1.1	Receiver Ingress Protection	IP64
1.2	Transmitter Ingress Protection	IP54
1.3	Operating Temperature	-20°C to 45°C (-4°F to 113°F)
1.4	Storage Temperature	-20°C to 70°C (-4°F to 158°F)
1.5	Humidity	0-95%, noncondensing
1.6	Altitude	5,000 meters (16,000 feet)
1.7	For Outdoor Use	Not in wet locations

Item	Description	Specification
<b>2 Mechanical</b>		
2.1	Receiver Weight	3.8 lbs.
2.2	Transmitter Weight	5.6 lbs.
<b>3 Power Supply</b>		
3.1	Transmitter Battery Pack, Rechargeable	Li-Ion Battery Pack, 4S2P, 14.4V ,99Wh, 6.9Ah
3.2	Transmitter Max Input Power	17 Watts at 14.4V
3.3	Receiver Battery, Rechargeable	26650 Battery Protected 5500mAh Li-ion Rechargeable 3.6V-3.7V
3.4	Receiver Max Input Power	1 Watt at 3.6V
3.5	Flexible Receiver Battery System	2 x D-Cell Alkaline
<b>4 Battery Operating Time</b>		
4.1	Transmitter, Li-Ion Battery Pack	8 hours @ 7.0 Watts
4.2	Receiver, 1 x Li-Ion, 26650	more than 17 hours
4.3	Receiver, 2 X D Cell (flexible)	more than 8 hours
<b>5 Transmitter Output</b>		
5.1	Transmitter Output Frequencies	512Hz, 8.125KHz, 33.025KHz, 82.175KHz. User selectable.
5.2	Maximum Transmitter Output Current	0.45A
5.3	Maximum Transmitter Output Voltage	90VRMS Max. User max voltage selection: 30V, 60V or 90V.
5.4	Maximum Transmitter Output Power	9.5W for 512Hz, 8.125KHz & 33.025KHz. 0.95W for 82.175KHz. User power selection: 1W,2W,3W,4W,5W,6W,7W,8W,9W,9.5W. For 82.175KHz power is set to 0.95W and is not selectable by the user.
5.5	Auto Power Down	To conserve battery life, an auto power down timer will turn the Transmitter off after a period of time. The timer may be set from 5 minutes to 9 hours 15 minutes. The timer function may be turned off and on by the user.
5.6	Stray Voltage Output Protection	Transmitter senses stray 50/60Hz voltages above 25V on the output. If the Transmitter is operating and 50/60Hz voltages above 25V are sensed, the Transmitter output will turn off automatically.

Item	Description	Specification
<b>6 Transmitter Operating Modes</b>		
6.1	Direct Connection	The direct connection accessory red lead is connected to the utility and the black lead is connected to a ground rod inserted into the ground.
6.2	Coupling Clamp Connection	The Coupling Clamp accessory is clamped around the pipe or cable. The clamp magnetically induces a signal into the utility without electrical connection to the utility.
6.3	Inductive Connection	The Transmitter's internal antenna radiates a magnetic field that energizes the utility.
<b>7 Receiver Operating Modes</b>		
7.1	Peak & Null Mode	Receiver gain adjusts automatically for peak audio pitch when directly over a utility.
7.2	Wide Peak Mode	Useful for detecting utilities from far lateral distances or utilities that are deeply buried.
7.3	Narrow Peak Mode	Useful when tracing in areas congested with multiple utilities.
7.4	Null Mode	Useful for determining the location of buried utilities having low field shape distortion.
7.5	Passive Power Mode	Trace buried utilities that are passively energized by AC power currents.
7.6	Sonde Mode	Detect sondes and measure sonde depth.
<b>8 Receiver Performance</b>		
8.1	Sensitivity	512 Hz 440µA @ 3ft 8kHz 40µA @ 3ft 33kHz 13µA @ 3ft 82kHz 13µA @ 3ft
8.2	Maximum depth	32' (10m) in all modes
<b>9 Connectors, External</b>		
9.1	Receiver	None
9.2	Transmitter Accessory Jack	Connector, 4 Pole, Chassis, Male, 25A, 250VAC Neutrik NL4MPXX
<b>10 Compliance: TW9000 conforms to the following standards</b>		
	47 CFR FCC Part 15, Subpart B	IEC 61326-1: 2020, EN 61326-1: 2021
	47 CFR Part 15, Subpart C	ETSI EN 301 489-1 V2.2.3
	ICES-003, Issue 7	ETSI EN 301 489-3 V2.1.1
	ICES-GEN, Issue 1	EN 303 454 V1.1.1
	RSS-GEN Issue 5	ANSI C63.4: 2014
	RSS-310: Cat 2, Issue 5:2020	IEC 61010-1: 2010

**LIMITED TWO-YEAR WARRANTY**

Fisher Research Labs warrants this instrument to be free of manufacturing defects for a period of two years after the date of purchase. This warranty gives you specific legal rights; you may also have other rights, as determined by your state or country. The manufacturer may elect to either repair or replace an instrument returned during the warranty period.

This warranty is void in the event any unauthorized person opens or repairs the instrument.

**THIS WARRANTY IS IN LIEU OF ALL OTHER WARRANTIES, EXPRESSED OR IMPLIED. FISHER RESEARCH LABS DOES NOT WARRANT SUITABILITY TO SPECIFIC USE. FISHER RESEARCH LABS SHALL IN NO EVENT BE LIABLE FOR ANY DIRECT, INCIDENTAL, CONSEQUENTIAL OR INDIRECT DAMAGES.**

**This warranty is non-transferable.**

Maintain proof of purchase. Proof of purchase must accompany warranty claim.

**NOTE TO CUSTOMERS LOCATED OUTSIDE U.S.A.**

This warranty may vary in other countries; check with your distributor for details. Warranty does not cover international shipping costs.

Warranty does not cover the cost of transporting this instrument back to an owner who is located outside of the United States of America.

According to FCC part 15.21, changes or modifications made to this device not expressly approved by the party responsible for compliance could void the operator's authority to operate this equipment.

This device complies with FCC Part 15 Subpart C Class A. Not to be used with conductive tracing cables longer than 6.5 ft. (1.98 m).

**FISHER**<sup>®</sup>RESEARCH  
LABS