

LR8450

LR8450-01

HIOKI

Instruction Manual

MEMORY HiLOGGER



99 Washington Street
Melrose, MA 02176
Phone 781-665-1400
Toll Free 1-800-517-8431

Visit us at www.TestEquipmentDepot.com



EN

Contents

Introduction.....	1
About the Notations Used in This Manual.....	2
How to Use This Manual	4

1 Settings and Operation 5

1.1 Performing Basic Operations.....	6
Instructions.....	6
Value entry method.....	7
Text entry method.....	8
1.2 Setting Measurement Conditions.....	10
Measurement module data refresh intervals.....	13
1.3 Configuring Input Channels	16
Measuring voltage	19
Measuring temperature (with thermocouples).....	21
Measuring temperature (with resistance temperature detectors).....	24
Measuring humidity.....	25
Measuring resistance.....	26
Measuring strain.....	27
Integrating pulses	29
Measuring rotational speed.....	31
Measuring logic signals.....	34
Treatment of data that exceeds the measurable range.....	35
1.4 Configuring the Waveform Display	36
Configuring the display of the vertical axis	36
Other display settings	40
1.5 Using the Scaling Function	42
1.6 Entering Comments	47
Title comments	47
Channel comments.....	48
Module identifiers.....	49
1.7 Configuring Channels in a List.....	50
Copying channel settings	55
Configuring channel settings at once.....	56
1.8 Performing Zero Adjustment.....	57
1.9 Checking Input Signals (Monitor Function).....	58
1.10 Starting and Stopping Measurement.....	59
1.11 Observing Waveforms	60
Waveform display	62
Gage (scale) display	65
Numerical value display	66
Moving waveforms (scrolling).....	69
Scroll bar (waveform display position).....	71
Enlarging and shrinking the waveform horizontally.....	71
Waveform search.....	72
Jump function (changing the display position)	74

1.12 Using the A/B Cursors	75
Reading values from the waveforms.....	75
Specifying a waveform range	77
1.13 Configuration Navigator (Quick Set).....	78
Strain gage connection diagram.....	78
External control terminal pin names.....	79

2 Trigger Function 81

2.1 Trigger Meanings.....	83
2.2 Enabling the Trigger Function.....	84
Shared settings.....	84
2.3 Analog Triggers, Pulse Triggers, Waveform Calculation Triggers (Level, Window).....	87
Level triggers.....	89
Window triggers.....	91
2.4 Logic Triggers (Patterns).....	92
2.5 Applying Triggers Based on External Sources	94
2.6 Activating a Trigger at a Set Interval.....	95
Interval triggers.....	95
2.7 Example Trigger Settings	97

3 Saving and Loading Data 99

3.1 Data That Can Be Saved and Loaded	100
3.2 Formatting Media.....	103
3.3 Saving Data.....	105
Auto save (real-time save)	106
Manual saving (selective saving, immediate saving).....	112
Selective save operation	114
3.4 Loading Data.....	117
3.5 Managing Data	119
Switching media (drives).....	119
Moving between levels (folders)	120
Deleting data	121
Renaming files and folders.....	122
Copying data	123
Sorting files	124
3.6 Acquiring Data with a Computer (PC).....	125
Connecting the USB cable	125
Activating USB drive mode.....	126
Canceling USB drive mode	127

4	Alarm (Alarm Output)	129
4.1	Configuring Alarms.....	130
	Setting shared alarm conditions for all channels.....	130
	Configuring channel-specific alarm settings.....	133
4.2	Checking Alarms.....	137
5	Marking Functionality	139
5.1	Assigning Event Marks during Measurement.....	140
5.2	Assigning Event Marks with an External Signal.....	141
5.3	Assigning Event Marks When Alarms Occur.....	142
5.4	Searching for Event Marks.....	143
5.5	Reviewing Events in CSV Data.....	144
6	Numerical and Waveform Calculations	145
6.1	Performing Numerical Calculations.....	146
	Configuring numerical calculations.....	147
	Real-time numerical calculations (automatic calculations).....	150
	Numerical calculations after measurement (manual calculations).....	151
	Partial numerical calculations.....	152
	Numerical calculation formulas.....	153
6.2	Performing Waveform Calculations.....	155
	Configuring calculations on the calculation list screen.....	160
	Copying calculation formulas.....	161
	Configuring waveform calculation settings at once.....	162
7	Configuring System Settings	163
7.1	Configuring Settings.....	164
7.2	Controlling the System.....	167
	Setting the time.....	167
	Synchronizing the time.....	168
	Initializing (resetting) the system.....	169
	System configuration.....	170
	Performing a self-check.....	171
8	External Control (EXT. I/O)	173
8.1	Configuring Voltage Output (VOUTPUT).....	174
8.2	Configuring Alarm Output (ALARM).....	175
8.3	Configuring External Input/Output (I/O) Terminals.....	177
	External trigger input.....	179
	Trigger output.....	180
	Simultaneously starting measurement using external triggers.....	182
9	Communicating with a Computer (PC)	183
9.1	Using the Logger Utility.....	185
9.2	Configuring and Establishing a USB Connection.....	186
	Installing the USB driver.....	186
	Connecting the instrument to the computer with a USB cable.....	188
9.3	Configuring and Establishing a LAN Connection.....	189
	Configuring the computer's network settings.....	191
	Configuring the instrument's LAN settings.....	192
	Connecting the instrument to a computer with a LAN cable.....	196
9.4	Exporting Acquired Data to a Computer Over Wireless LAN.....	199
	Configuring and Establishing a Wireless LAN Connection (LR8450-01 only).....	199
9.5	Performing Remote Measurement with the HTTP Server.....	201
	Connecting to the HTTP server.....	201
	Remote control using a browser.....	203
	Starting and stopping measurement.....	204
	Entering comments.....	205
9.6	Acquiring Data Using the FTP Server.....	206
9.7	Sending Data Using the FTP Client.....	210
	Example computer FTP server settings.....	211
	Configuring automatic sending of data.....	225
	Sending a test file.....	227
	Checking FTP communications status.....	228
9.8	Controlling the Instrument with Communication Commands.....	229

10 Specifications 231

10.1 Basic Specifications231
 LR8450/LR8450-01 Memory HiLogger231
 10.2 Plug-in Module Specifications243
 U8550 Voltage/Temp Unit.....243
 U8551 Universal Unit249
 U8552 Voltage/Temp Unit.....255
 U8553 High Speed Voltage Unit262
 U8554 Strain Unit265

11 Knowledge and Information 269

11.1 Measuring Temperature.....269
 11.2 Measuring Strain270
 Tension and compression on a single axis270
 Bending stress.....271
 Torsional stress.....272
 Converting values to stress273
 Auto-balancing.....273
 Correcting for wiring resistance274
 Correcting for gage factor.....274
 11.3 Digital filter characteristics275
 11.4 Noise Countermeasures.....276
 Noise contamination mechanisms276
 Example noise countermeasures.....278
 11.5 Scan Timing.....282
 U8550, U8551, LR8530, and LR8531283
 U8552 and LR8532.....284
 U8553 and LR8533.....285
 11.6 Filenames286
 11.7 Text Format287
 11.8 File Size289
 11.9 Settings after Initialization (System Reset)290
 11.10 Maximum Recording Times292
 11.11 Application Measurement.....293
 Recording instrumentation signals (4-20 mA)293
 Measuring power consumption using pulse output from a watt-hour meter296
 11.12 Input Circuit Schematics.....299
 11.13 Data Handling302
 11.14 Displaying the Certification Number304

Index 305

11

4

5

6

7

8

9

10

Index

Introduction

Thank you for purchasing the Hioki LR8450/LR8450-01 Memory HiLogger. To ensure your ability to get the most out of the instrument over the long term, please read this manual carefully and keep it available for future reference.

The LR8450-01 Memory HiLogger adds wireless LAN functionality to the LR8450.

The instrument comes with the following documentation. Please refer to these resources as necessary in light of your specific application. Please review the separate “Operating Precautions” before using the instrument.

Type	Manual contents	Printed edition	CD edition
Operating Precautions	Information to ensure safe use of the instrument	✓	–
Precautions Concerning Use of Equipment That Emits Radio Waves	Precautions relating to use of equipment that emits radio waves, countries in which the instrument has been certified, etc.	✓	–
Quick Start Manual	Basic connection and operating instructions for the instrument	✓	✓
Instruction Manual (this manual)	Detailed information about the instrument and specifications	–	✓
Logger Utility* ¹ User Manual	Information about how to install and use the computer application	–	✓
Communications Commands* ² User Manual	Explanation of communications commands for controlling the instrument	–	✓

*1: For information about how to install and use the Logger Utility computer application, see “Logger Utility User Manual” on the included CD (application disc).

*2: The instrument can be controlled by a LAN- or USB-connected computer (PC).
For more information about the communications commands used to control the instrument, see “Communications Commands User Manual” on the included CD (application disc).

Intended audience

This manual has been written for use by individuals who use the product or provide information about how to use the product.

In explaining how to use the product, it assumes electrical knowledge (equivalent of the knowledge possessed by a graduate of an electrical program at a technical high school).

Trademarks

- Microsoft, Windows, Excel, Internet Explorer, and Visual Basic are the registered trademarks or trademarks of Microsoft Corporation in the U.S., Japan, and other countries.
- Other products and company names are the trade names, registered trademarks or trademarks of their respective owners.







Screen font

- The typefaces included herein are solely developed by DynaComware Taiwan Inc.







About the Notations Used in This Manual

Safety notations



This manual classifies seriousness of risks and hazard levels as described below.

 DANGER	Indicates an imminently hazardous situation that, if not avoided, will result in death of or serious injury to the operator.
 WARNING	Indicates a potentially hazardous situation that, if not avoided, could result in death of or serious injury to the operator.
 CAUTION	Indicates a potentially hazardous situation that, if not avoided, could result in minor or moderate injury to the operator.
NOTICE	Indicates the possibility of equipment damage.
IMPORTANT	Indicates information or content that is particularly important from the standpoint of operating or maintaining the instrument.
	Indicates a high-voltage hazard. Failure to verify safety or improper handling of the instrument could lead to electric shock, burns, or death.
	Indicates an action that must not be performed.
	Indicates action that must be performed.

Symbols on equipment

	Indicates the need for caution or the presence of a hazard. For more information about locations where this symbol appears on instrument components, see "Operating Precautions" in the Quick Start Manual, warning messages listed at the beginning of operating instructions, and the document entitled "Operating Precautions" that comes with the instrument.
	Indicates an instrument that has been protected throughout by double insulation or reinforced insulation.
	Indicates whether the power is on or off.
	Indicates the ground terminal.
	Indicates direct current (DC).
	Indicates alternating current (AC).

Notations related to standards compliance

	Indicates compliance with the Waste Electrical and Electronic Equipment (WEEE) Directive in EU member nations.
 Li-ion	Indicates that the instrument is targeted for recycling under the Act on the Promotion of Effective Utilization of Resources.
	Indicates that the instrument complies with standards imposed by EU directives.

Other notations

	Indicates useful advice concerning instrument performance and operation.
*	Instructs the reader to see below for additional information.
<input checked="" type="checkbox"/>	Indicates the default setting. When initialized, the instrument will revert to this value.
(p.)	Indicates the page number to reference.
Bold	The names of control keys are printed in bold.
[]	The names of user interface elements on the screen are enclosed in brackets ([]).
Windows	Unless otherwise noted, the term “Windows” is used generically to refer to Windows 7, Windows 8, and Windows 10.
S/s	For the instrument, the number of times the analog input signal is digitized is indicated in samples per second (S/s). Example: 20 MS/s (20 megasamples per second) signifies 20×10^6 samples per second.

Accuracy

Hioki defines tolerances for measured values in terms of f.s. (full scale), as indicated below.

f.s.	Maximum display value, scale magnitude Indicates the maximum display value or scale magnitude. Generally speaking, the f.s. figure indicates the range in current use. Example: f.s. for the 1 V range = 1 V
------	---

How to Use This Manual

How to open screens

- SET** : SET key
- Channel** : Main tab
- Individual** : Sub tab

Step number

Numbers are the same as those used in the instructions.

Selections and explanations

Indicates the selections that can be made by pressing the **ENTER** key and explains them.
 Indicates the default setting.

Measuring voltage

This section describes how to configure settings on the individual settings screen when measuring voltage.

You can use **[Input]** on the setting list screen to configure the settings. (See p.50.)

Applicable modules: U8550, U8551, U8552, U8553, U8554, LR8530, LR8531, LR8532, LR8533, LR8534

SET > **Channel** > **Individual**

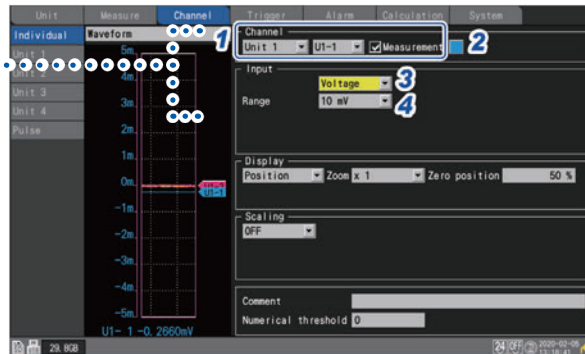

1 Select the module and channel to configure and select the checkbox.

Measurement will not be performed for channels whose checkboxes are not selected.

2 Select the waveform display color.

(OFF), 24 colors

Select if you wish to measure the channel but not to display its waveform or numerical values on the screen.

3 Set the input type to **[Voltage]**.

For the U8553 and LR8533, the setting cannot be changed from **[Voltage]**.

4 Under **[Range]**, select the measurement range as appropriate for the measurement target.

(For the U8550, U8551, U8552, LR8530, LR8531, or LR8532)

10 mV, 20 mV, 100 mV, 200 mV, 1 V, 2 V, 10 V, 20 V, 100 V, 1 to 5 V

(For the U8553 or LR8533 High Speed Voltage Unit)

100 mV, 200 mV, 1 V, 2 V, 10 V, 20 V, 100 V, 1 to 5 V

(For the U8554 or LR8534 Strain Unit)

1 mV, 2 mV, 5 mV, 10 mV, 20 mV, 50 mV, 100 mV, 200 mV



This chapter introduces basic settings and instrument operation.

Before starting measurement, you must set measurement conditions such as recording interval and range. You must also configure input channel settings such as input signal types and ranges.

1.1 Performing Basic Operations	p. 6
1.2 Setting Measurement Conditions	p. 10
1.3 Configuring Input Channels	p. 16
1.4 Configuring the Waveform Display	p. 36
1.5 Using the Scaling Function	p. 42
1.6 Entering Comments	p. 47
1.7 Configuring Channels in a List	p. 50
1.8 Performing Zero Adjustment	p. 57
1.9 Checking Input Signals (Monitor Function)	p. 58
1.10 Starting and Stopping Measurement	p. 59
1.11 Observing Waveforms	p. 60
1.12 Using the A/B Cursors	p. 75
1.13 Configuration Navigator (Quick Set)	p. 78

1.1 Performing Basic Operations

Instructions

SET > ■■■■■ > □□□□)■■■■■ : main tab; □□□□ : sub tab)

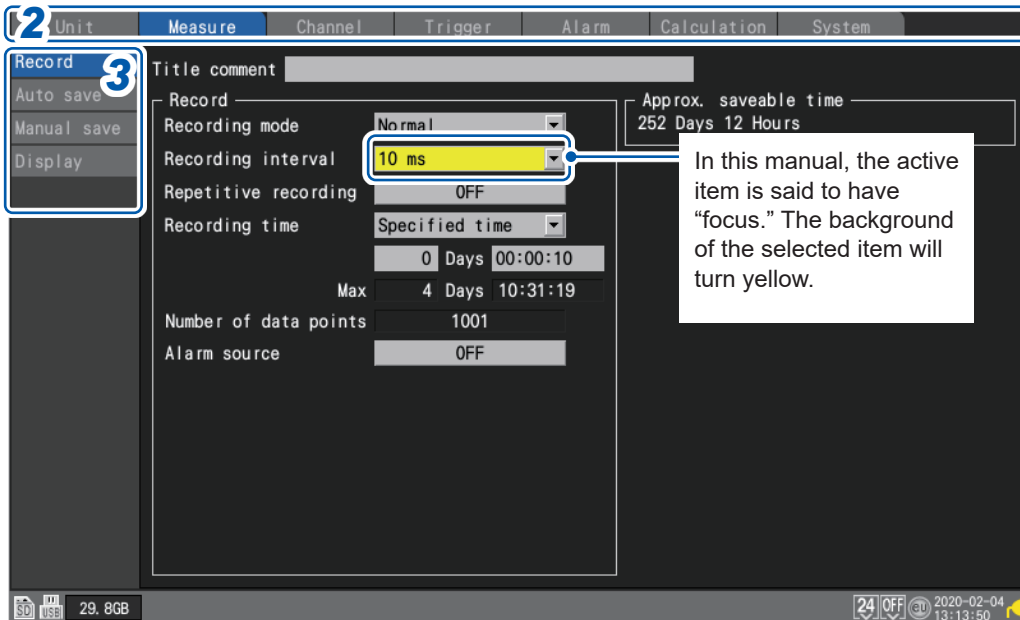

- 1 Press the **SET** key to display the settings screen.
- 2 Select the main tab you wish to configure with the **Left Arrow** and **Right Arrow** keys.



You can also switch among the main tabs using the **SET** key.
 You can move the focus among sub tabs by pressing the **ENTER** key.
 You can return the focus to the main tab by pressing the **ESC** key.

- 3 Select the sub tab whose settings you wish to configure with the **Up Arrow** and **Down Arrow** keys

You can move the focus to the settings area by pressing the **ENTER** key.
 You can return the focus to the sub tab by pressing the **ESC** key.

- 4 Select the setting you wish to configure with the **Left Arrow**, **Right Arrow**, **Up Arrow**, and **Down Arrow** keys and then press the **ENTER** key.

The available settings will be displayed.

- 5 Select an option with the **Up Arrow** and **Down Arrow** keys and then press the **ENTER** key.

The setting will be accepted.

IMPORTANT
 Unless otherwise directed, do not press multiple keys simultaneously. The instrument could exhibit unintended behavior.

Tips You can prevent accidental or unintended operation by enabling the key lock feature to disable key operation.
 See “Key lock (disabling keys)” in the Quick Start Manual.



Value entry method

This section describes how to enter values.

Numerical value entry window

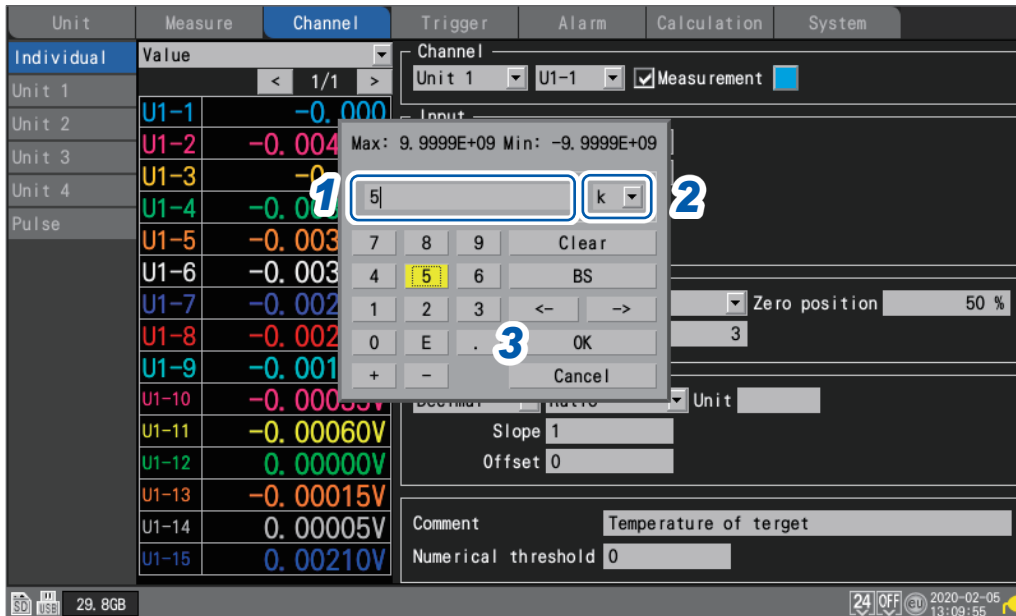

Clear	Clears the value.
BS	Deletes one digit (backspace).
←	Moves left one digit.
→	Moves right one digit.
OK	Accepts the value.
Cancel	Closes the window without entering a value.

- 1** Select the desired value with the **Left Arrow**, **Right Arrow**, **Up Arrow**, and **Down Arrow** keys and then press the **ENTER** key.

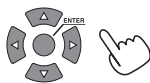

The selected value will be entered.

- 2** Select the **SI prefix**.

P, T, G, M, k, , m, μ, n, p, f

The open box “” indicates a blank space.

- 3** Press the **ENTER** key while **[OK]** is selected. Alternatively, press the **START** key. The window will close, and the value will be entered.

Text entry method

This section describes how to enter comments and filenames. You can enter single-byte alphanumeric and characters only.

Text entry window



- 1** Select a character with the **Left Arrow**, **Right Arrow**, **Up Arrow**, and **Down Arrow** keys and press the **ENTER** key.
- 2** Press the **START** key (**OK**). Alternatively, or press the **ENTER** key while **[OK]** is selected. The text entry window will close.

When saved in text format, some characters are saved using alternative characters as follows:

Character used on the instrument	Saved character
²	^2
³	^3
μ	~u
Ω	~o

Text entry

You can perform the operations listed below by choosing the operation on the screen and pressing the **ENTER** key.

You can also use the corresponding key to perform the same operation.

Operation on screen	Corresponding key	Description
OK	START	Accepts the character.
Cancel	ESC	Closes the window without entering any text.
Clear	FILE	Deletes all entered text.
BS	◀	Deletes the previous character (backspace).
DEL	▶	Deletes the next character (delete).
<<	◀◀	Moves the cursor to the left.
>>	▶▶	Moves the cursor to the right.

1.2 Setting Measurement Conditions

This section describes how to configure settings such as the recording interval and recording time. Settings cannot be changed while measurement is in progress. Stop measurement and then change the settings.

You can select the recording method.

Continuous recording



Sets the recording time setting to **[Continuous]**. Recording will continue until you press the **STOP** key. Recording can be stopped with a trigger. See "Stop triggers" (p.84).

Time-specified recording



Sets the recording time setting to **[Specified time]**. The setting indicates the amount of time for which to record (the recording length). Recording will stop once the set time has elapsed. Recording can be stopped before the set time elapses with the **STOP** key or a trigger.

Repeat recording



Sets the repeat recording setting to **[ON]**. Recording will resume after stopping (due to stop trigger conditions or the completion of recording for the set recording time). Recording will repeat until you press the **STOP** key. If the repeat recording setting is **[OFF]**, recording will stop after one iteration.

SET > Measure > Record

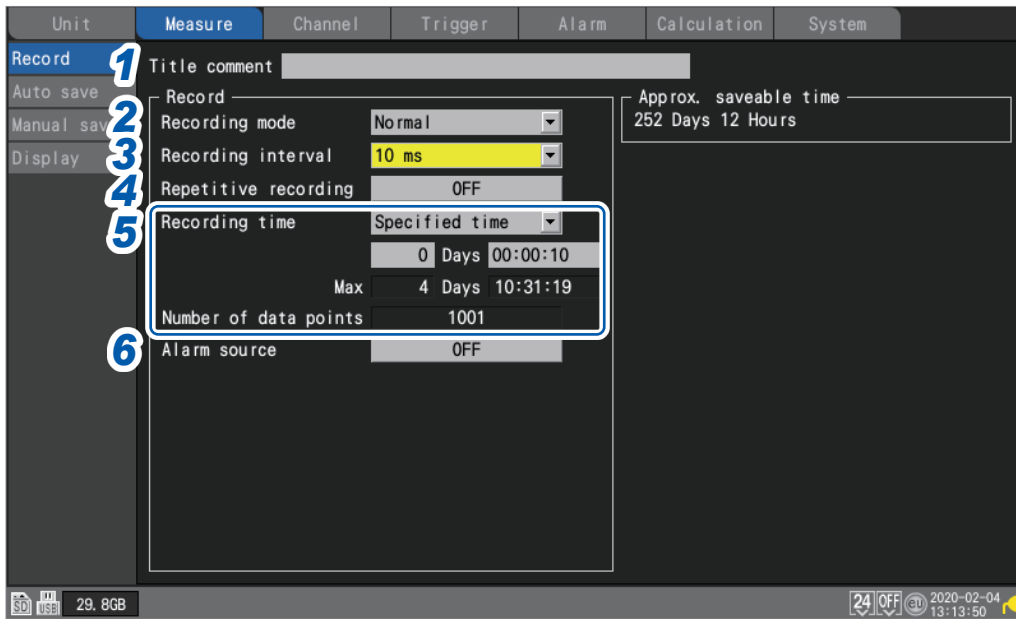

1 Enter a title comment in the [Title comment] field (optional).
See “Title comments” (p.47).

2 Under [Recording mode], select type of recording.

Normal <input checked="" type="checkbox"/>	Data is recorded in synchronization with the internal clock.
---	--

The setting cannot be changed from [Normal]. Hioki plans to add new functionality in the future.

3 Under [Recording interval], select the data capture interval.

Example: Choosing [10 ms] will cause data to be captured at a 10 ms interval (100 times per second).

<p>1 ms*¹, 2 ms*¹, 5 ms*¹, 10 ms, 20 ms, 50 ms, 100 ms, 200 ms, 500 ms, 1 s, 2 s, 5 s, 10 s, 20 s, 30 s, 1 min, 2 min, 5 min, 10 min, 20 min, 30 min, 1 h</p>

*1: Setting available only when using a module with data refresh intervals including 1 ms. (when there is at least one U8553, U8554, LR8533, or LR8534 module for which measurement is enabled).

4 Under [Repetitive recording], choose whether to repeat recording operation.

OFF <input checked="" type="checkbox"/>	Stops recording after one iteration.
ON	Repeats recording operation. Measurement will stop when you press the STOP key.

5 Under **[Recording time]**, set the amount (length) of time for which you wish to record data.

Specified time	Records for the set amount of time. (Max. 500 days) Days, hours, minutes, seconds
Continuous <input checked="" type="checkbox"/>	Recording will continue until you press the STOP key. Measurement can also be stopped with a trigger. See "Stop triggers" (p.84).

If you select **[Specified time]**, the maximum time and data count will be displayed. The maximum amount of time that you can record varies with the number of channels in use and the recording interval.

If you select **[Continuous]**, measurement will continue while deleting past data from the internal buffer memory if the maximum capacity of the internal buffer memory is exceeded. It is recommended to use auto saving since deleted data cannot be restored.

See "Auto save (real-time save)" (p. 106).

6 Under **[Alarm source]**, choose whether to record the alarm source channel during alarms.

Set to **[ON]** when you're using an alarm and you wish to save data for the alarm source channel.

Set as necessary as the amount of data will increase.

OFF , **ON**

When the recording time is set to [Specified time] and repeat recording is set to [ON]

Internal processing will take some time (downtime) between the time that recording stops after the specified amount of time has elapsed and the start of the next recording operation. Recording is not performed during this time.

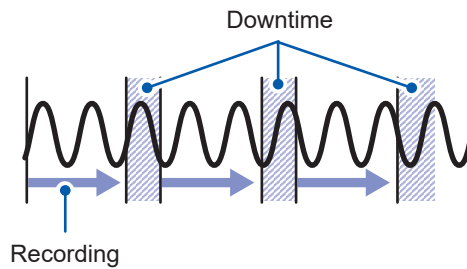

Tips You can record without any downtime by setting the recording time to **[Continuous]** and enabling auto saving and file segmentation. Saved data files can be segmented using the desired time segment.

Measurement module data refresh intervals

This section describes how to set the data refresh interval for each measurement module separately from the instrument's recording interval.

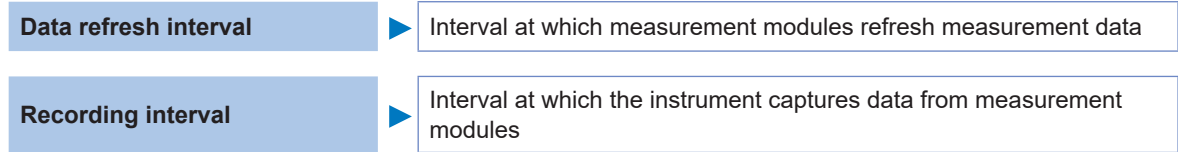

SET > Unit

A list of connected modules will be displayed.

- [Unit 1] to [Unit 4]: Plug-in modules
- [Remote 1] to [Remote 7]: Wireless modules

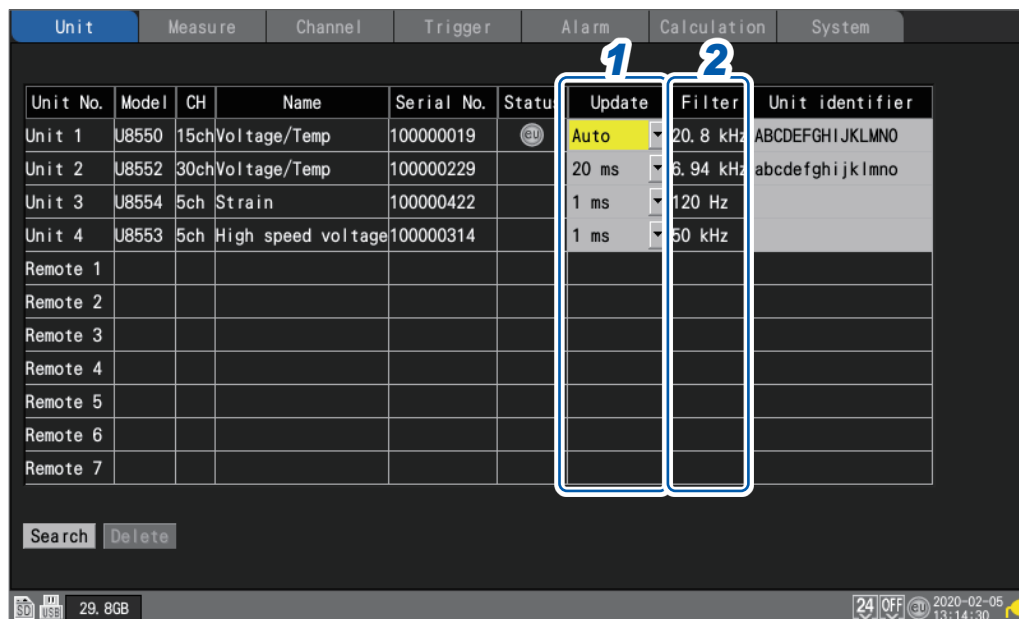

1 Under [Update], select the data refresh interval.

Auto , 1 ms, 2 ms, 5 ms, 10 ms, 20 ms, 50 ms, 100 ms, 200 ms, 500 ms, 1 s, 2 s, 5 s, 10 s

Ordinarily, this setting should be set to [Auto]. When you choose [Auto], the shortest data refresh interval will be set for each module based on the recording interval.

The available data refresh interval settings vary with the modules in use and the wire break detection setting.

Wire break detection	U8550, U8551, LR8530, LR8531	U8552, LR8532	U8553, U8554, LR8533, LR8534
OFF	From 10 ms* ¹	From 20 ms* ²	From 1 ms* ⁴
ON	From 20 ms* ¹	From 50 ms* ³	

*1: Settings start at 100 ms when using a Pt1000 with the U8551 or LR8531.

*2: When using 15 or fewer channels, the 10 ms setting is available.

*3: When using 15 or fewer channels, the 20 ms setting is available.

*4: No wire break detection function is available.

Tips

- When the data refresh interval is set to a value other than [Auto], it is recommended to use longer times. This will allow you to reduce the digital filter's cutoff frequency to eliminate low-frequency noise.
- You can eliminate power supply frequency noise by setting the data refresh interval so that the [Filter] setting is 50 Hz or 60 Hz.

2 Under [Filter], check the filter’s cutoff frequency.

The filter’s cutoff frequency will change depending on the data refresh interval setting. Check the cutoff frequency that is displayed for each module.

Relationship between the data refresh interval and the recording interval

- Measurement modules send data to the instrument once each data refresh interval.
- The instrument receives data from measurement modules once each recording interval.
- Even if a measurement module’s data refresh interval is short, it will not be possible to record waveform peaks if the instrument’s recording interval is long.

	Data refresh interval		Recording interval	
	Short	Long	Short	Long
Strength of the power supply frequency filter	Weak	Strong	–	–
Data volume	–	–	More data	Less data
Waveform peaks	Easier to capture*	More difficult to capture	Easier to capture*	More difficult to capture

*: If the data refresh interval and recording interval are short.

- For the U8550 to U8553 and LR8530 to LR8533 modules, the longer the data refresh interval, the lower the digital filter cutoff frequency, yielding more effective noise rejection. For more information about cutoff frequencies, see the section about each module’s digital filter in “10.2 Plug-in Module Specifications” (p.243).
- To maximize the effectiveness of the digital filter, configure the [Power frequency filter] setting according to the power supply frequency in the region where the instrument is being used. See “7.1 Configuring Settings” (p.164).
- For modules whose data refresh interval is longer than the recording interval, the first two data points will be continuous, and there will be a delay.

Differences in measurement data caused by data refresh intervals and recording intervals

●: Point in measurement data

Module

Data refresh interval: 1 s

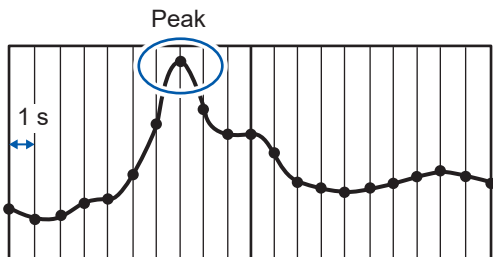

LR8450/LR8450-1

Recording interval: 2 s

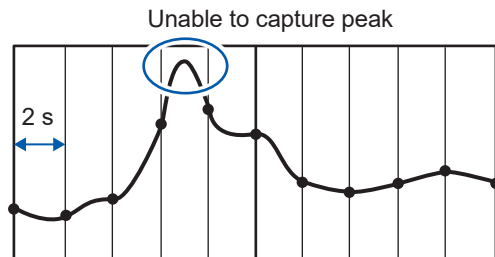

Module

Data refresh interval: 1 s

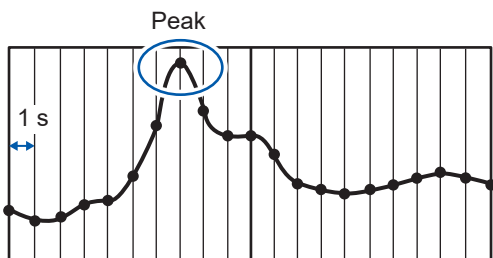

LR8450/LR8450-1

Recording interval: 1 s

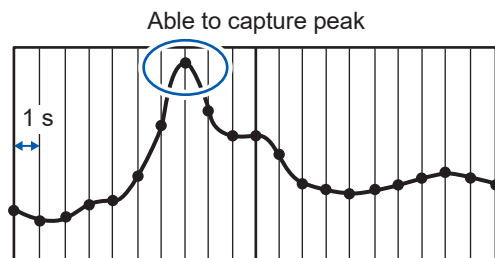

Example setting

What you want to do	Data refresh interval	Recording interval
Record a signal that's changing quickly (electrical signal, etc.)	Shorter	Shorter
Record a signal that's changing slowly (temperature, etc.)	Longer	Longer
Record fast and slow signals at the same time	Shorter for modules used to measure fast signals Longer for modules used to measure slow signals	Shorter

Since you can set the data refresh interval separately for each module, the instrument can be used as follows:

- For module 1, set the data refresh interval to 2 s so that you can eliminate power supply noise and reduce the effects of noise when performing temperature measurement using thermocouples.
- For module 2, set the data refresh interval to 10 ms so that you can record battery voltage fluctuations.
- For module 3, set the data refresh interval to 1 ms so that you can record changes in control signals at the maximum speed.
- Set the instrument's recording interval to 1 ms, reflecting the shortest data refresh interval. The instrument will record data from modules 1 through 3 every 1 ms.

If the instrument's recording interval is shorter than a module's data refresh interval, the same value will be recorded for that module's data.

Example: If the recording interval is 1 ms and the data refresh interval is 1 s, 1000 pieces of data all of which have the same value will be recorded.

For more information about the module identifier, see "Module identifiers" (p.49); about the filter of U8554 and LR8534 Strain Unit, "Measuring strain" (p.27).

Data refresh interval of pulses

Pulse data will be refreshed at the data refresh intervals.

The data refresh interval of pulses will automatically be set depending on input types.

Input type		Data refresh interval
Integration		1 ms
Rotational speed	r/s or r/min (Smoothing: 1 s)	10 ms
	r/min (Smoothing: 2 s to 60 s)	50 ms

- The data refresh interval setting does not affect pulse counting processes.
- Even if the data refresh interval of pulses is equal to that for the measurement module, these data will not simultaneously be refreshed when the recording interval is shorter than the data refresh interval.

1.3 Configuring Input Channels

Configure input channels for voltage measurement, temperature measurement, etc.

Channel	▶ Un-m The letters <i>n</i> and <i>m</i> represent a module number and a channel number, respectively.
Input	▶ Selects the type of measurement target. Voltage, thermocouple, humidity, etc.
Range	▶ Sets the magnitude of the input signal.

Set the waveform color, scaling, and comments as necessary.

These settings can be configured either on each channel's individual settings screen or on the settings list screen for multiple channels.

Setting method

- 1** Set the main tab to **[Channel]**.
- 2** Select the settings screen on the sub tab.
 - **[Individual]**
Configure the settings on the individual settings screen for each channel.
 - **[Unit n]** ($n = 1, 2, \dots$)
Configure the settings on the settings list screen for each module.
 - **[Pulse]**
Configure the settings on the settings list screen.
- 3** Press the **ENTER** key.
The focus will move to the settings area.
You can return the focus to the sub tab by pressing the **ESC** key.
- 4** Select the setting you wish to configure with the **Left Arrow**, **Right Arrow**, **Up Arrow**, and **Down Arrow** keys.
- 5** Press the **ENTER** key.
The available settings will be displayed.
- 6** Select the desired setting with the **Up Arrow** and **Down Arrow** keys and then press the **ENTER** key.
The setting will be accepted.

Individual settings screen

A settings screen will be displayed for each channel.

Under **[Channel]**, select the module and channel to configure.

Configure the range and display for the selected channel.

A waveform monitor is shown on the left side of the screen. You can also switch the display format to show numerical values.

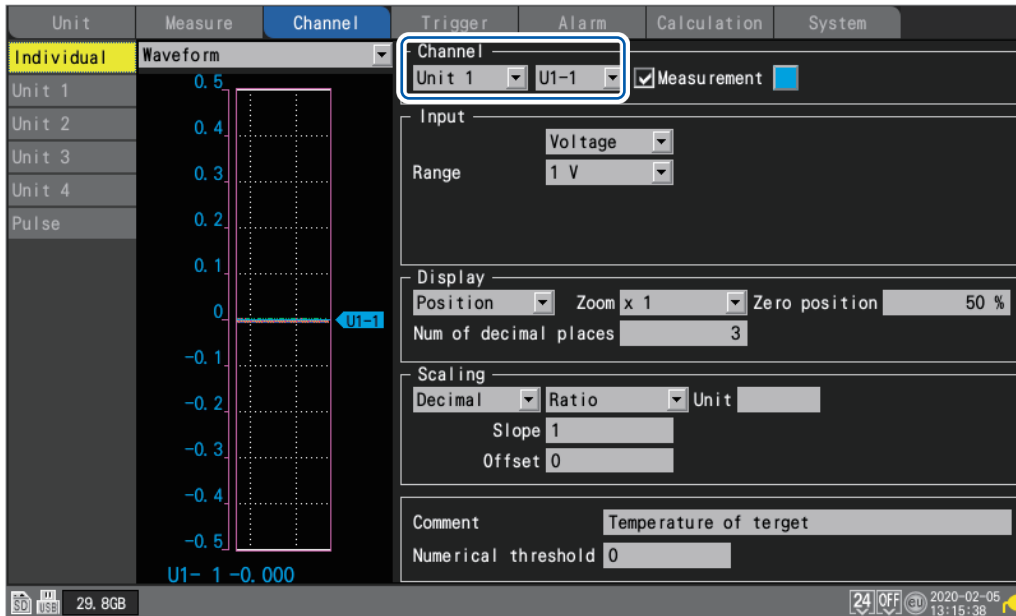

Settings list screen

This screen displays a list of settings for each module.

For more information about the settings list screen, see “1.7 Configuring Channels in a List” (p.50).

The following settings can be configured on the settings list screen:

- Measurement on/off
- Waveform display colors
- Input, display, scaling, comment, and numerical value calculation settings (Available settings depend on the type of module.)
- Zero-adjustment (U8554 and LR8534: auto balancing)

Select a channel number and press the **ENTER** key to display the individual settings window. You can also configure settings on the individual settings window.

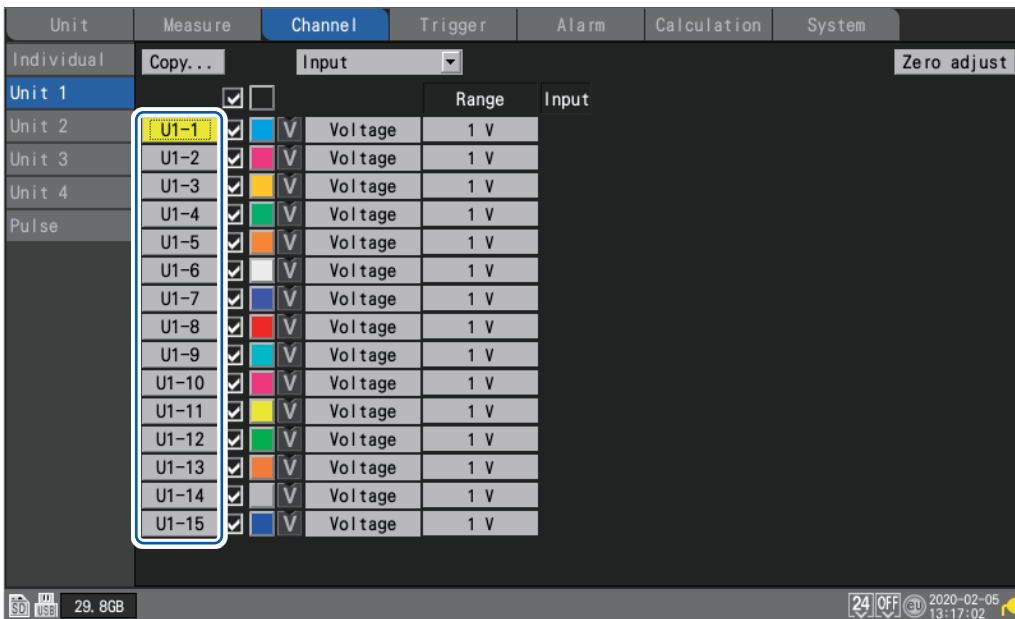

Individual settings window (close with the **ESC** key)

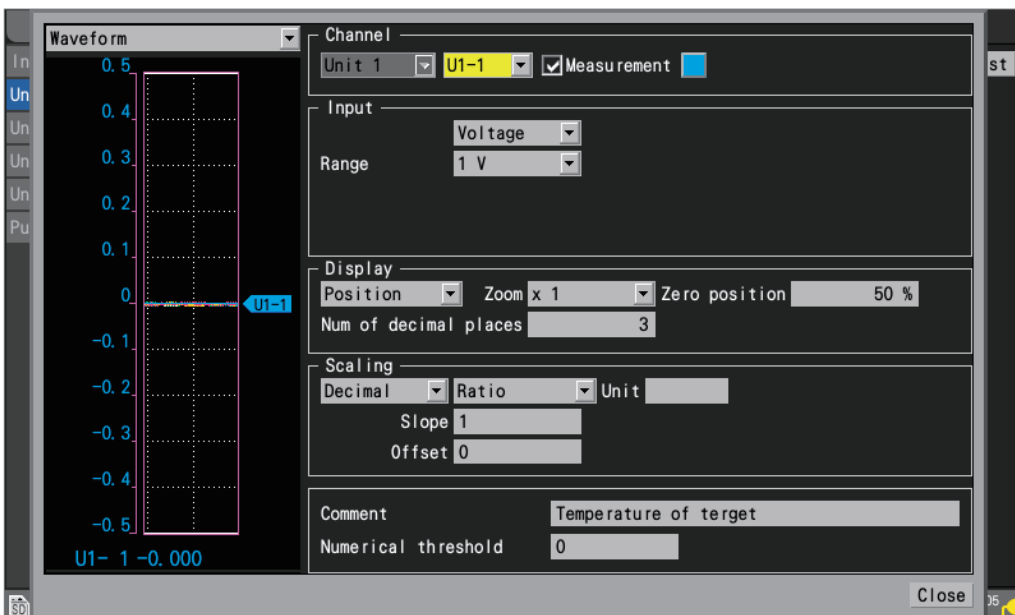

Measuring voltage

This section describes how to configure settings on the individual settings screen when measuring voltage.

You can use **[Input]** on the settings list screen to configure the settings. (See p.50.)

Applicable modules: U8550, U8551, U8552, U8553, U8554, LR8530, LR8531, LR8532, LR8533, LR8534

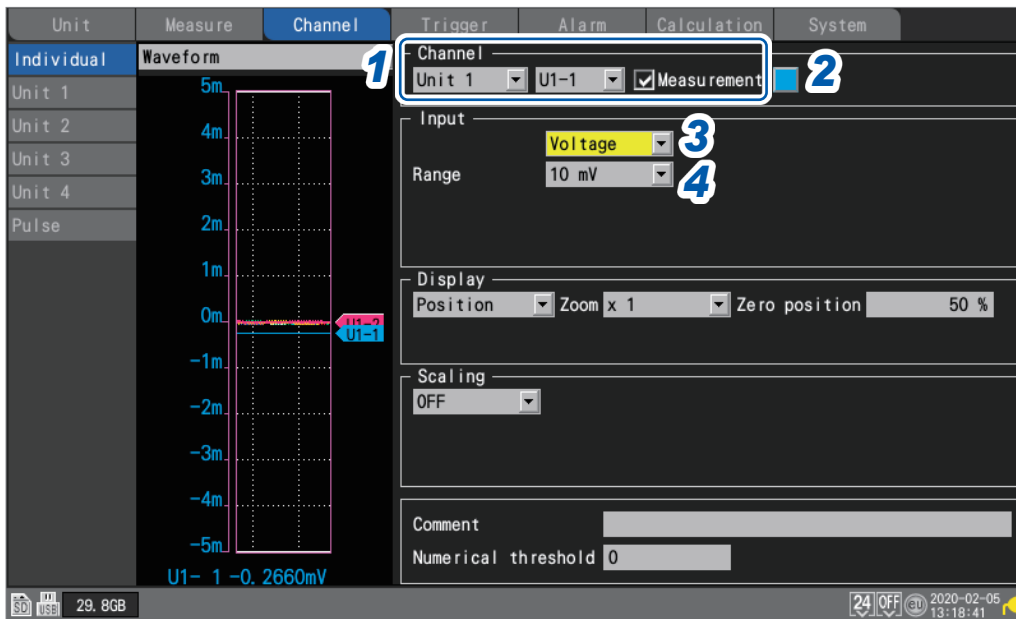

1 Select the module (Unit) and channel to configure and select the checkbox. Measurement will not be performed for channels whose checkboxes are not selected.

2 Select the waveform display color.

× (OFF), 24 colors

Select **[×]** if you wish to measure the channel but not to display its waveform or numerical values on the screen.

3 Set the input type to **[Voltage]**.

For the U8553 and LR8533, the setting cannot be changed from **[Voltage]**.

4 Under **[Range]**, select the measurement range as appropriate for the measurement target.

(For the U8550, U8551, U8552, LR8530, LR8531, or LR8532)

10 mV , 20 mV, 100 mV, 200 mV, 1 V, 2 V, 10 V, 20 V, 100 V, 1 to 5 V

(For the U8553 or LR8533 High Speed Voltage Unit)

100 mV , 200 mV, 1 V, 2 V, 10 V, 20 V, 100 V, 1 to 5 V

(For the U8554 or LR8534 Strain Unit)

1 mV , 2 mV, 5 mV, 10 mV, 20 mV, 50 mV, 100 mV, 200 mV

5 (For the U8554 or LR8534 Strain Unit)

Under **[Filter]**, select the cutoff frequency.

Auto , 120 Hz, 60 Hz, 30 Hz, 15 Hz, 8 Hz, 4 Hz

See the table in “Measuring strain” (p.27) for a list of cutoff frequencies when **[Auto]** is selected.

When measuring instrumentation devices

- When measuring a 4-20 mA current, connect a 250 Ω resistor between the positive and negative input terminals.
See “Connecting voltage cables and thermocouples” in the Quick Start Manual.
- The **[1-5 V]** range is convenient when measuring output from 4-20 mA instrumentation devices.
- The **[1-5 V]** range is a range in which the lower and upper limits of the **[10 V]** range’s display range are automatically set to 1 V and 5 V, respectively. If you wish to change the upper and lower limit values, use the **[10 V]** range.
- The Strain Unit does not support 4-20 mA current measurement.



You can use the scaling function to convert measured voltage values to the desired values. See “1.5 Using the Scaling Function” (p.42).

Measuring temperature (with thermocouples)

This section describes how to configure settings on the individual settings screen when measuring temperature using thermocouples.

You can use **[Input]** on the settings list screen to configure the settings. (See p.50.)

Applicable modules: U8550, U8551, U8552, LR8530, LR8531, LR8532

SET > **Channel** > **Individual**

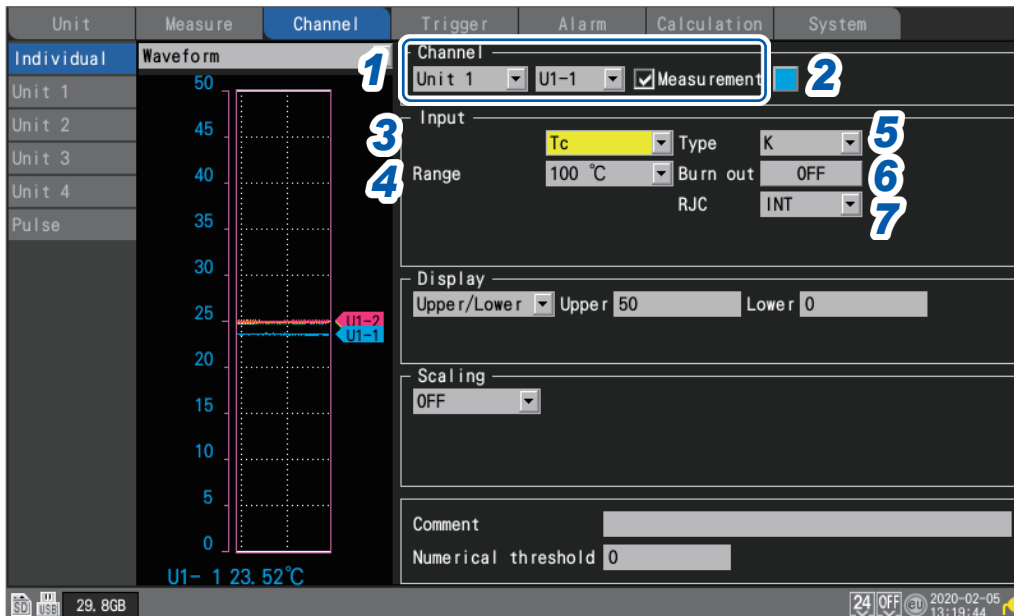

1 Select the module (Unit) and channel to configure and select the checkbox. Measurement will not be performed for channels whose checkboxes are not selected.

2 Select the waveform display color.

× (OFF), 24 colors

Select **[×]** if you wish to measure the channel but not to display its waveform or numerical values on the screen.

3 Set the input type to **[Tc]**.

4 Under **[Range]**, select the measurement range as appropriate for the temperature being measured.

100°C , 500°C, 2000°C

B thermocouples cannot be selected for the 100°C and 500°C ranges. When using B thermocouples, set the range to 2000°C first.

5 Under **[Type]**, select the type of thermocouple you're using.

K , J, E, T, N, R, S, B*, C

*:**[B]** can be selected when using the 2000°C range. See "Measurable temperature range" (p.22).

6 Under [Burn out], select whether you wish to detect wire breaks.

OFF <input checked="" type="checkbox"/>	Does not detect thermocouple wire breaks. Values will vary when a thermocouple experiences a wire break.
ON	Detects thermocouple wire breaks when measuring temperature using thermocouples. The numerical value display and cursor value will be indicated as [BURNOUT] when a wire break occurs. Calculated values and saved data are treated as 327.66°C (100°C f.s. range), 1638.3°C (500°C f.s. range), or 3276.6°C (2000°C f.s. range). There are limits on the data refresh interval that can be set. See “Thermocouple wire break detection” (p.23).

7 Under [RJC], select the type of reference junction compensation to use.

INT <input checked="" type="checkbox"/>	Performs reference junction compensation inside the measurement module. Use this setting when the thermocouple (or compensation lead wire) is connected directly to the instrument. The measurement accuracy is determined by adding the temperature measurement accuracy to the reference junction compensation accuracy.
EXT	Does not perform reference junction compensation inside the measurement module. Use this setting when connecting an external zero junction compensation device (0°C ice water, etc.). The measurement accuracy is defined by the temperature measurement accuracy alone.

Measurable temperature range

The measurable temperature range depends on the type of thermocouple being used.

Thermocouple	Measurable temperature range
K	-200°C to 1350°C
J	-200°C to 1200°C
E	-200°C to 1000°C
T	-200°C to 400°C
N	-200°C to 1300°C
R	0°C to 1700°C
S	0°C to 1700°C
B*	400°C to 1800°C
C	0°C to 2000°C

*: **[B]** can be selected when using the 2000°C range. Temperatures from 0°C to 400°C will be displayed even if **[B]** is selected, but accuracy will not be guaranteed.



Thermocouple wire break detection

- The system checks for wire breaks by applying a minuscule current each data refresh interval when measuring temperature using thermocouples.
- Measured values are not affected since wire breaks are detected when measurement is not being performed.
- If the data refresh intervals are the same, setting **[Burn out]** to **[ON]** will result in less effective noise rejection since it results in a cutoff frequency that is higher than the **[OFF]** setting. Check “Digital filter” of each module in “10.2 Plug-in Module Specifications” (p.243) for the cutoff frequency.
- If the thermocouple resistance exceeds roughly the next value, the system will determine that a wire break has occurred.

Thermocouple	Range		
	100°C f.s.	500°C f.s.	2000°C f.s.
K	260 Ω	5400 Ω	2940 Ω
J	470 Ω	4150 Ω	200 Ω
E	1530 Ω	5970 Ω	9290 Ω
T	220 Ω	5440 Ω	5440 Ω
N	520 Ω	1470 Ω	590 Ω
R	50 Ω	40 Ω	890 Ω
S	50 Ω	80 Ω	1300 Ω
B	–	–	2090 Ω
C	220 Ω	910 Ω	3090 Ω

When using a long thermocouple with **[Burn out]** set to **[ON]**, use a thick-diameter wire to avoid false wire break detection.

Measuring temperature (with resistance temperature detectors)

This section describes how to configure settings on the individual settings screen when measuring temperature using resistance temperature detectors.

You can use **[Input]** on the settings list screen to configure the settings. (See p.50.)

Applicable modules: U8551, LR8531

SET > **Channel** > **Individual**

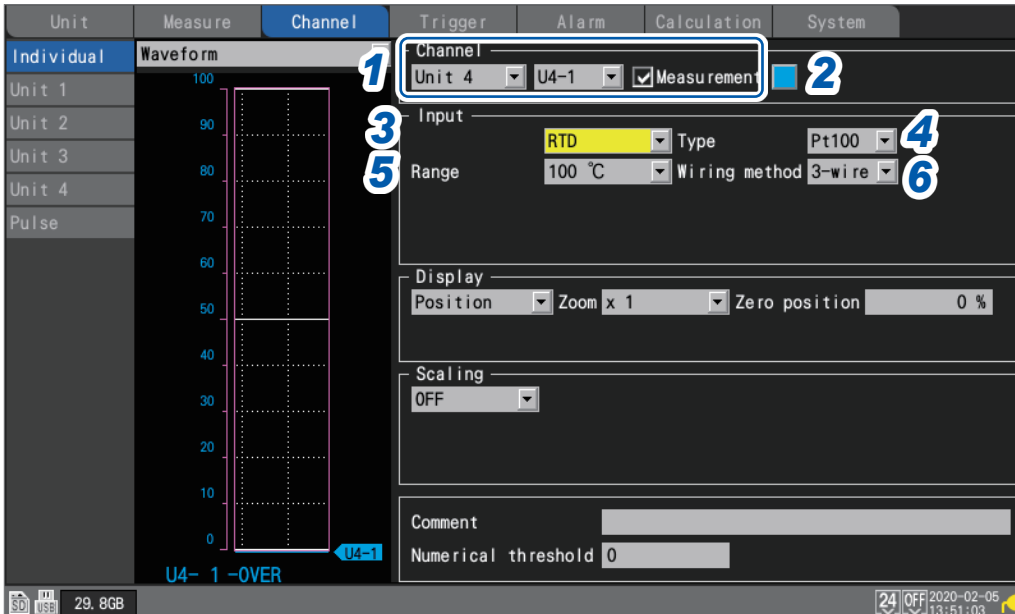

- 1** Select the module (Unit) and channel to configure and select the checkbox. Measurement will not be performed for channels whose checkboxes are not selected.

- 2** Select the waveform display color.

× (OFF), 24 colors

Select **[×]** if you wish to measure the channel but not to display its waveform or numerical values on the screen.

- 3** Set the input type to **[RTD]**.

- 4** Under **[Type]**, select the type of resistance temperature detector you're using.

Pt100 , JPt100, Pt1000

When **[Pt1000]** is selected, the **[10 ms]**, **[20 ms]**, and **[50 ms]** data refresh interval settings will not be available.

- 5** Under **[Range]**, select the measurement range as appropriate for the temperature being measured.

100°C , 500°C, 2000°C

- 6** Under **[Wiring method]**, select a the wiring method of the resistance temperature detector.

3-wire <input checked="" type="checkbox"/>	3-wire resistance temperature detector.
4-wire	4-wire resistance temperature detector.

Measuring humidity

This section describes how to configure settings on the individual settings screen when measuring humidity with the optional Humidity Sensor.

You can use **[Input]** on the settings list screen to configure the settings. (See p.50.)

Applicable modules: U8550, U8551, U8552, LR8531

Applicable sensor: Z2000 Humidity Sensor

SET > **Channel** > **Individual**

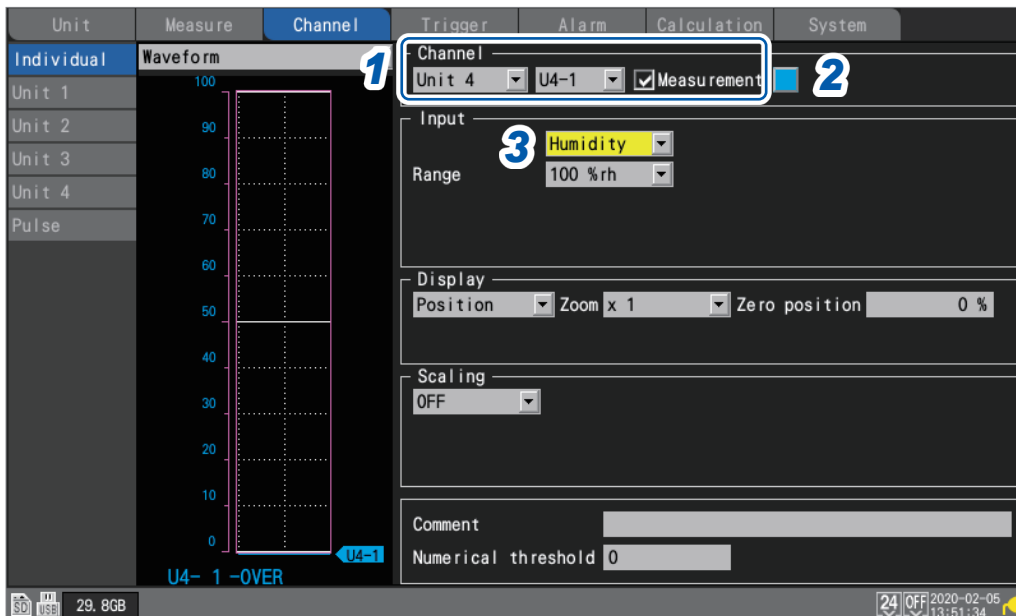

- 1** Select the module (Unit) and channel to configure and select the checkbox. Measurement will not be performed for channels whose checkboxes are not selected.
- 2** Select the waveform display color.

× (OFF), 24 colors

Select **[×]** if you wish to measure the channel but not to display its waveform or numerical values on the screen.

- 3** Set the input type to **[Humidity]**. There is no range setting (the setting cannot be changed from the 100% RH range).

Measuring resistance

This section describes how to configure settings on the individual settings screen when measuring resistance.

You can use **[Input]** on the settings list screen to configure the settings. (See p.50.)

Applicable modules: U8551, LR8531

SET > **Channel** > **Individual**

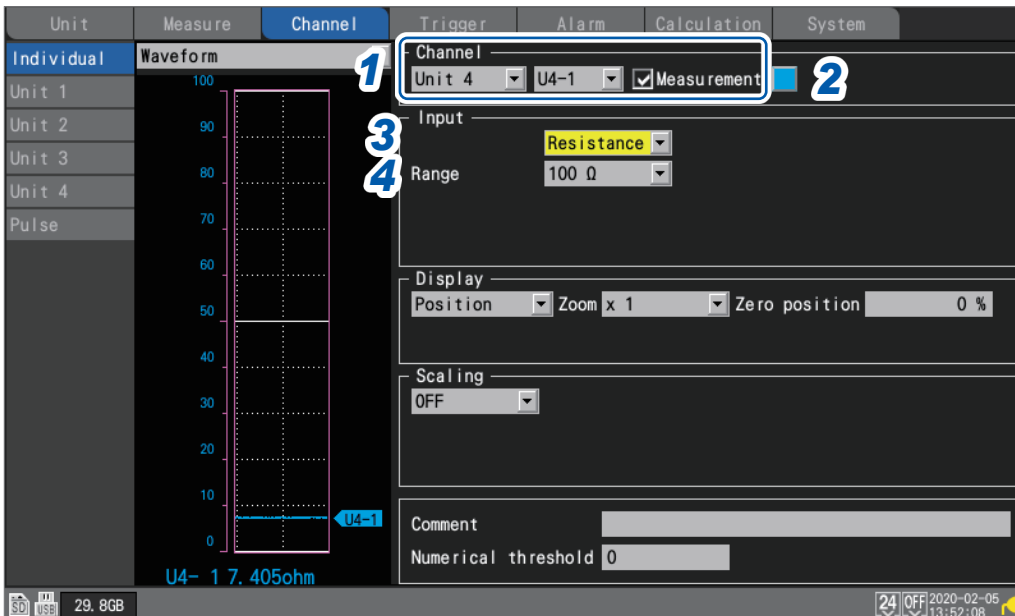

- 1** Select the module (Unit) and channel to configure and select the checkbox. Measurement will not be performed for channels whose checkboxes are not selected.

- 2** Select the waveform display color.

× (OFF), 24 colors

Select **[×]** if you wish to measure the channel but not to display its waveform or numerical values on the screen.

- 3** Set the input type to **[Resistance]**.
- 4** Under **[Range]**, select the measurement range as appropriate for the resistance being measured.

10 Ω , 20 Ω, 100 Ω, 200 Ω

IMPORTANT

When measuring an inductive load such as winding resistance, the instrument's response may not be able to keep up, preventing accurate measurement. If you encounter this issue, increase the data refresh interval. As a general rule, inductors of up to 100 mH can be measured with a data refresh interval of 100 ms.

Measuring strain

This section describes how to configure settings on the individual settings screen when measuring strain or vibration with a strain gage or strain gage-type converter. You can use **[Input]** on the settings list screen to configure the settings. (See p.50.)
 Applicable modules: U8554, LR8534

- Measuring strain** ▶ See “11.2 Measuring Strain” (p.270).
- Converting measured values using scaling based on the gage factor or a strain gage-type converter’s rated value** ▶ See “1.5 Using the Scaling Function” (p.42).
- Connecting a strain gage or strain gage-type converter** ▶ See “Connecting a strain gage or strain gage-type converter” in the Quick Start Manual.

SET > Channel > Individual

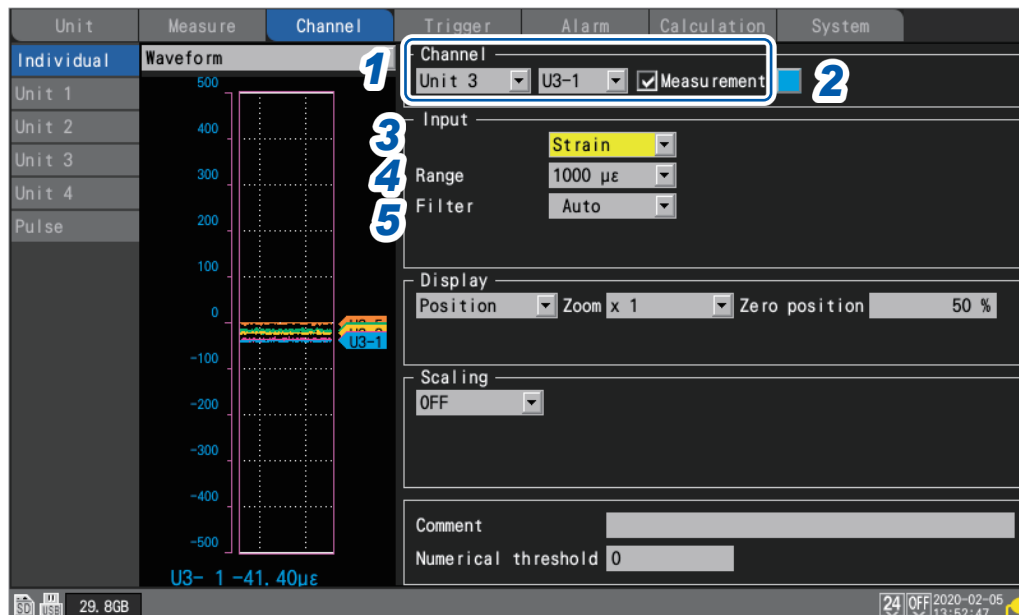

- 1** Select the module (Unit) and channel to configure and select the checkbox. Measurement will not be performed for channels whose checkboxes are not selected.

- 2** Select the waveform display color.

× (OFF), 24 colors

Select **[×]** if you wish to measure the channel but not to display its waveform or numerical values on the screen.

- 3** Set the input type to **[Strain]**.

- 4** Under **[Range]**, select the measurement range as appropriate for the measurement target.

1000 με , 2000 με, 5000 με, 10000 με, 20000 με, 50000 με, 100000 με, 200000 με

The instrument expresses strain in terms of micro epsilon (μ ϵ).

5 Under **[Filter]**, select the cutoff frequency.

Auto , 120 Hz, 60 Hz, 30 Hz, 15 Hz, 8 Hz, 4 Hz

When **[Auto]** is selected, the low-pass filter’s cutoff frequency will automatically be set as described in the following table based on the set data refresh interval:

Data refresh interval	Cutoff frequency	Data refresh interval	Cutoff frequency
1 ms	120 Hz	200 ms	4 Hz
2 ms	60 Hz	500 ms	4 Hz
5 ms	30 Hz	1 s	4 Hz
10 ms	15 Hz	2 s	4 Hz
20 ms	8 Hz	5 s	4 Hz
50 ms	4 Hz	10 s	4 Hz
100 ms	4 Hz		

6 On the **[Wave+Set]** screen, press the **ENTER** key while **[Auto-bal]** is selected on the bottom right of the screen.

Auto-balancing will be performed for all channels of the Strain Unit.

Perform this step under the following conditions:

- Turn on the instrument and wait 30 minutes.
- Connect a strain gage or strain gage-type converter to the module; however, do not apply any loads, including vibration.
- Connect the B and D inputs terminals with one another when measuring voltage.

Auto-balancing cannot be performed while measurement is in progress.

Key operations are ignored while auto-balancing is in progress.

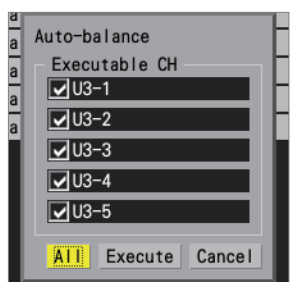

Auto-balancing can also be performed using the **[Auto-balance]** button on the top right of the channel list screen. Press the **ENTER** key to display the settings window. Select the checkboxes for the channels for which you wish to perform auto-balancing. Then press the **ENTER** key while **[Execute]** is selected. Press the **ENTER** key while **[All]** is selected to select or cancel auto-balancing for all channels at once. See “1.7 Configuring Channels in a List” (p.50).

Perform auto-balancing again in the following circumstances:

- When the input types have changed
- When the range has changed
- When module connections have changed
- When the strain gage or strain gage-type converter has changed
- When the instrument’s power has been cycled
- When the instrument’s settings have been initialized
- When the ambient temperature has changed abruptly (when the zero position may have drifted)

If auto-balancing fails, check the following:

- Is the strain gage or strain gage-type converter in a no-load state?
- Is the strain gage or strain gage-type converter connected properly?

Integrating pulses

You can perform measurement by integrating the pulse count from an integrating wattmeter, flow meter, or similar device.

This section describes how to configure settings on the individual settings screen when performing integration measurement.

You can use the settings list screen to configure the settings. See p.52.

External control terminals: Pulse input terminals P1 to P8

SET > Channel > Individual

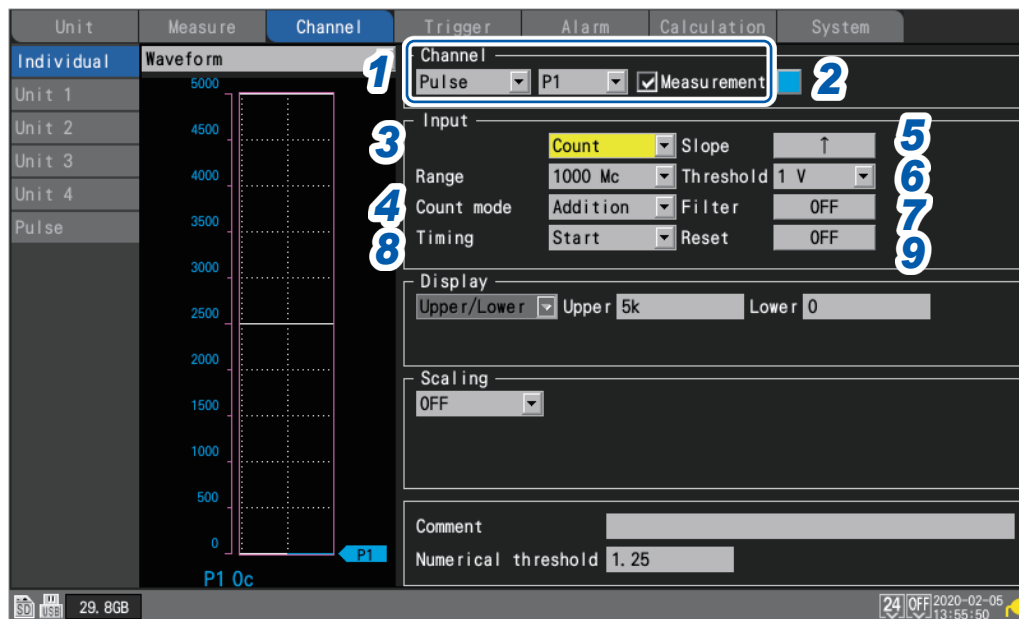

1 Select **[Pulse]**, and choose a channel from **[P1]** to **[P8]**.

Measurement will not be performed for channels whose checkboxes are not selected.

2 Select the waveform display color.

× (OFF), 24 colors

Select **[×]** if you wish to measure the channel but not to display its waveform or numerical values on the screen.

3 Set the input type to **[Count]**.

The range cannot be changed from 1000 Mc.

4 Under **[Count mode]**, select the integration method.

Addition <input checked="" type="checkbox"/>	Measures the integrated value for the number of pulses from the start of measurement.
Instant	Measures the number of pulses inputted to the instrument during the recording interval. The pulse count will be reset for each recording interval.

5 Under **[Slope]**, select the slope to count.

↑ <input checked="" type="checkbox"/>	Integrates the number of times the pulse switches from low level to high level (rising).
↓	Integrates the number of times the pulse switches from high level to low level (falling).

6 Under [Threshold], select the level used for counting.

1 V <input checked="" type="checkbox"/>	Treats voltages that are greater than or equal to 1.0 V as high level and voltages that are greater than or equal to 0 V but less than 0.5 V as low level.
4 V	Treats voltages that are greater than or equal to 4.0 V as high level and voltages that are greater than or equal to 0 V but less than 1.5 V as low level.

7 Under [Filter], select whether to use the chatter prevention filter.

Set to **[ON]** to prevent false counting due to chatter in mechanical contact (relay) output.

OFF <input checked="" type="checkbox"/> , ON
--

8 Under [Timing], select when to reset counting.

Start <input checked="" type="checkbox"/>	Resets the count to zero at the start of measurement.
Trigger	Resets the count to zero at the start of measurement and at which a trigger activates. The values acquired before the reset are recorded for the trigger point.

9 Under [Reset], select the operation to perform when the integrated value overflows.

OFF <input checked="" type="checkbox"/>	Stops counting.
ON	Resets the count value and resumes counting from zero.

<p>Tips</p>	<ul style="list-style-type: none"> You can use the scaling function to convert the integrated pulse count into the measurement target's physical properties (Wh, VA, etc.) and display the result. See "1.5 Using the Scaling Function" (p.42). The upper limit that can be measured is 1,000,000,000 pulses. If the possibility exists that this limit may be exceeded, it is recommended to perform measurement using the instantaneous integration mode and integrate the pulses later using Excel® or other software.
--------------------	---



Measuring rotational speed

This section describes how to measure the pulses output by a rotary encoder, tachometer, or similar device.

The instrument counts the number of pulses per second and calculates the rotational speed.

This section describes how to configure settings on the individual settings screen when measuring rotational speed.

You can use the settings list screen to configure the settings. (See p.52.)

External control terminals: Pulse input terminals P1 to P8

SET > Channel > Individual

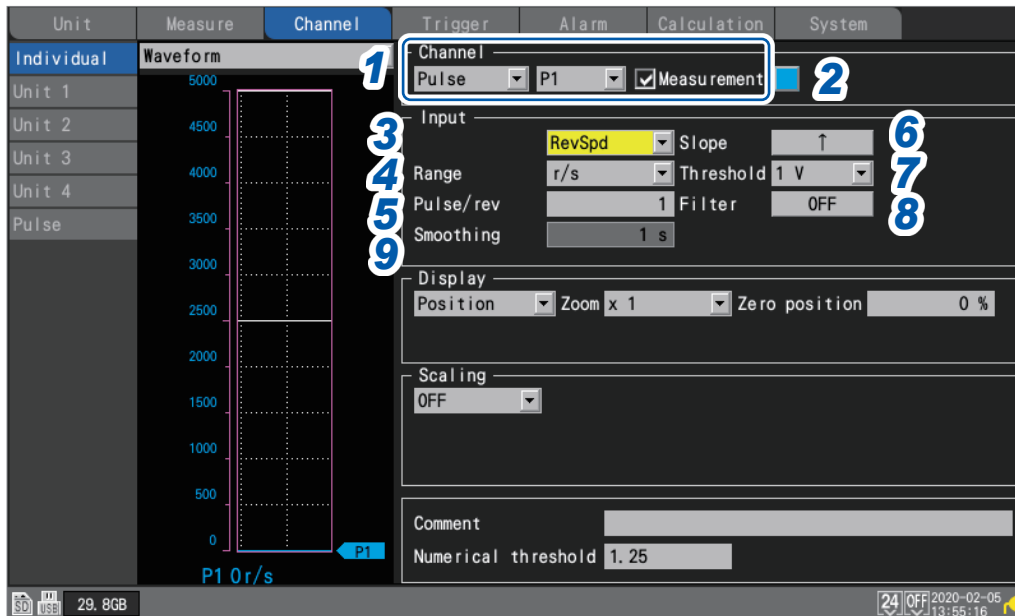

- 1 Select **[Pulse]**, and choose a channel from **[P1]** to **[P8]**.

Measurement will not be performed for channels whose checkboxes are not selected.

- 2 Select the waveform display color.

× (OFF), 24 colors

Select **[×]** if you wish to measure the channel but not to display its waveform or numerical values on the screen.

- 3 Set the input type to **[RevSpd]**.

- 4 Under **[Range]**, select the count base time.

r/s <input checked="" type="checkbox"/>	Counts the number of pulses per second and calculates the rotational speed. (Number of revolutions per second)
r/min	Counts the number of pulses per module of time specified with the [Smoothing] setting and calculates the rotational speed. (Number of revolutions per minute)

- 5 Under **[Pulse/rev]**, enter the number of pulses per revolution output by the encoder or tachometer.

1 to 1000

- 6 Under **[Slope]**, select the slope to count.

↑ <input checked="" type="checkbox"/>	Integrates the number of times the pulse switches from low level to high level (rising).
↓	Integrates the number of times the pulse switches from high level to low level (falling).

7 Under **[Threshold]**, select the level to count.

1 V <input checked="" type="checkbox"/>	Treats voltages that are greater than or equal to 1.0 V as high level and voltages that are greater than or equal to 0 V but less than 0.5 V as low level.
4 V	Treats voltages that are greater than or equal to 4.0 V as high level and voltages that are greater than or equal to 0 V but less than 1.5 V as low level.

8 Under **[Filter]**, select whether to use the chatter prevention filter.

Set to **[ON]** to prevent false counting due to chatter in mechanical contact (relay) output.

OFF , **ON**

9 Under **[Smoothing]**, enter the smoothing processing time (when **[Range]** is set to **[r/min]**).

1 s to **60 s**

Principal of rotational speed measurement

Under the following conditions, the integration pulse count is internally updated at a data refresh interval of 10 ms:

- When the range is **[r/s]**
- When the range is **[r/min]** and smoothing is set to **[1 s]**

The rotational speed at time t [s] is calculated by dividing the pulse count from $(t - 1)$ to t [s] by the number of pulses per revolution.

$$r \text{ (r/s)} = \frac{\text{Integrated pulse count at } t \text{ [s]} - \text{integrated pulse count at } (t - 1) \text{ [s]}}{\text{Number of pulses per revolution}}$$

r/s: Rotational speed per second

$$r \text{ (r/min)} = \frac{\text{Integrated pulse count at } t \text{ [s]} - \text{integrated pulse count at } (t - 1) \text{ [s]}}{\text{Number of pulses per revolution}} \times 60$$

r/min: Rotational speed per minute (with smoothing set to **[1 s]**)

Example: Number of pulses per revolution = 4
 Integrated pulse count at 1 s = P1 = 1000 c
 Integrated pulse count at 2 s = P2 = 2000 c
 The rotation speed at $t = 2$ s ($r_{t=2}$) can be calculated as follows:
 $r_{t=2} = (2000 - 1000) / 4 = 250 \text{ r/s}$

When the range is set to **[r/min]** and smoothing is set to t_0 [s], the integrated pulse count is internally updated at a data refresh rate of 50 ms.
 The rotational speed at time t [s] is calculated by dividing the pulse count from $(t - t_0)$ to t [s] by the number of pulses per revolution and multiplying the result by 60.

$$r \text{ (r/min)} = \frac{\text{Integrated pulse count at } t \text{ [s]} - \text{integrated pulse count at } (t - t_0) \text{ [s]}}{\text{Number of pulses per revolution}} \times \frac{60}{t_0}$$



When the range is [r/min]

If the time t [s] is less than t_0 (time specified with the smoothing), the displayed rotational speed will be the actual rotational speed. (however, t_0 is equal to or more than 2 s).

If an unintentional trigger activates, set the smoothing time at 1 s.

Example when $t_0 = 5$ s

The rotational speed recorded value will spend t_0 [s] from the start of measurement to increase. Even if the inputted rotational speed remains constant, the smoothing process will cause the recorded data to show an increase after the start of measurement until t_0 [s].

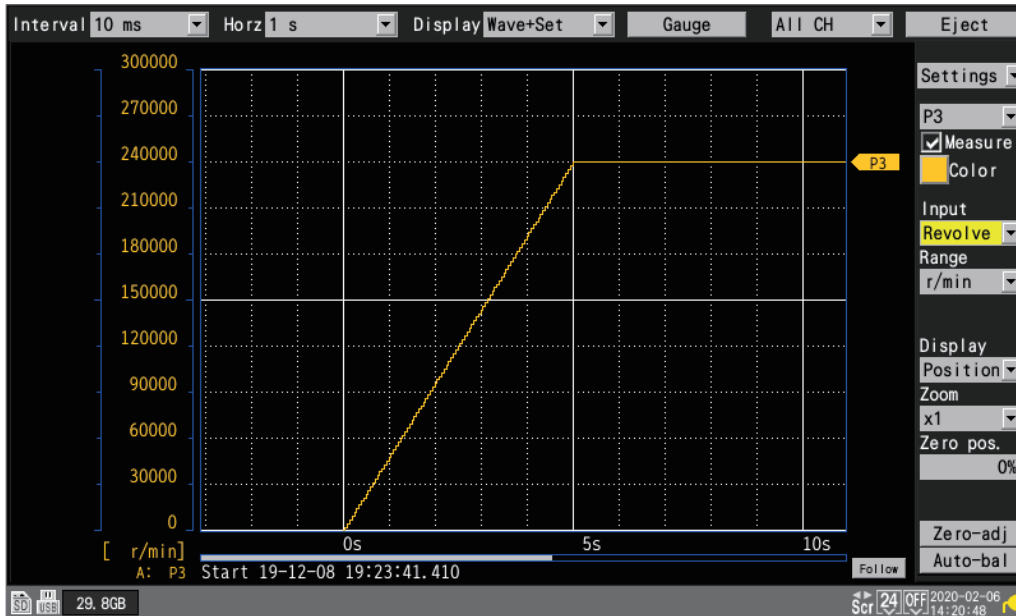

Measuring logic signals

This section describes how to configure settings on the individual settings screen when measuring logic signals.

You can use the settings list screen to configure the settings. (See p.52.)

External control terminals: Pulse input terminals P1 to P8

SET > **Channel** > **Individual**

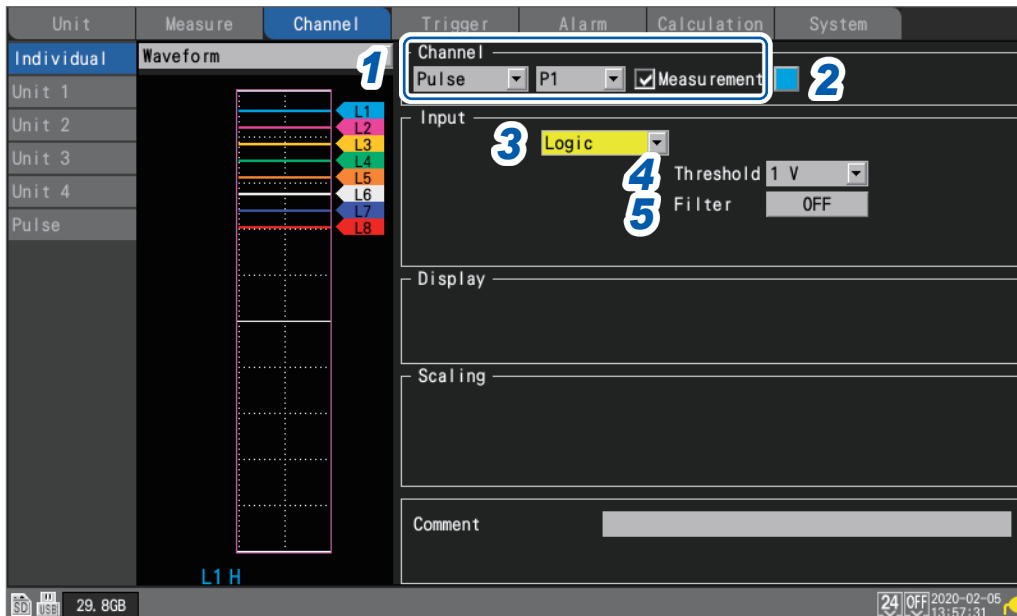

1 Select **[Pulse]**, and choose a channel from **[P1]** to **[P8]**,

Measurement will not be performed for channels whose checkboxes are not selected.

2 Select the waveform display color.

× (OFF), 24 colors

Select **[×]** if you wish to measure the channel but not to display its waveform on the screen.

3 Set the input type to **[Logic]**.

4 Under **[Threshold]**, select the level to count.

1 V <input checked="" type="checkbox"/>	Treats voltages that are greater than or equal to 1.0 V as high level and voltages that are greater than or equal to 0 V but less than 0.5 V as low level.
4 V	Treats voltages that are greater than or equal to 4.0 V as high level and voltages that are greater than or equal to 0 V but less than 1.5 V as low level.

5 Under **[Filter]**, select whether to use the chatter prevention filter.

Set to **[ON]** to prevent false counting due to chatter in mechanical contact (relay) output.

OFF , **ON**

Treatment of data that exceeds the measurable range

Regardless of the measurement target, measured values that exceed the measurable range are treated as over-range values, resulting in a display of either **[+OVER]** or **[-OVER]** on the numerical value display and for A/B cursor values.

Treatment of such values in saved data and calculation results is described in “11.13 Data Handling” (p.302).

The screen will display a waveform saturated by the value described in “11.13 Data Handling” (p.302).

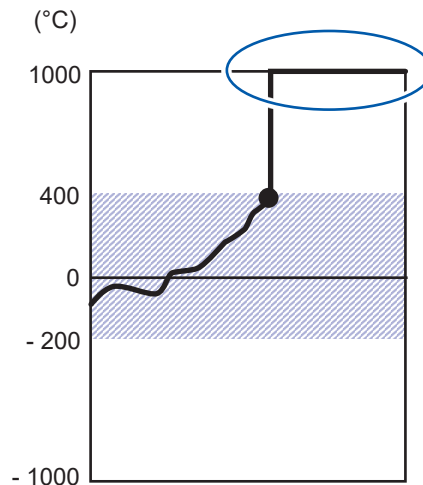

When using wire break detection in thermocouple measurement, values are treated as follows:

- When there is a wire break or the thermocouple’s measurable range is exceeded in the positive direction, the value is treated as a wire break (BURNOUT).
- When the thermocouple’s measurable range is exceeded in the negative direction, the value is treated as (-OVER).

1.4 Configuring the Waveform Display

This section describes how to set how waveforms are displayed (display color, display position, zoom factor, etc.).

Configuring the display of the vertical axis

This section describes how to configure the display in the vertical axis direction. You can set the waveform display position and zoom factor for each channel on the individual settings screen.

You can use **[Display]** on the settings list screen to configure the settings. (See p. 50.)

There are two methods for setting the display position:

- Setting the zoom factor and zero position
- Setting upper and lower limit values

Setting the zoom factor and zero position

Set the waveform display position by specifying the zoom factor and zero position (position of 0 V that serves as the reference).

The zoom factor will be increased and decreased based on the zero position.

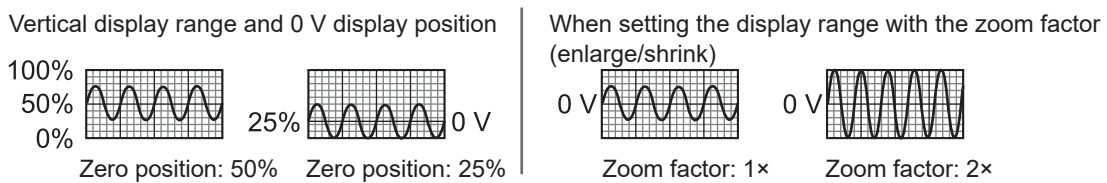

SET > **Channel** > **Individual**

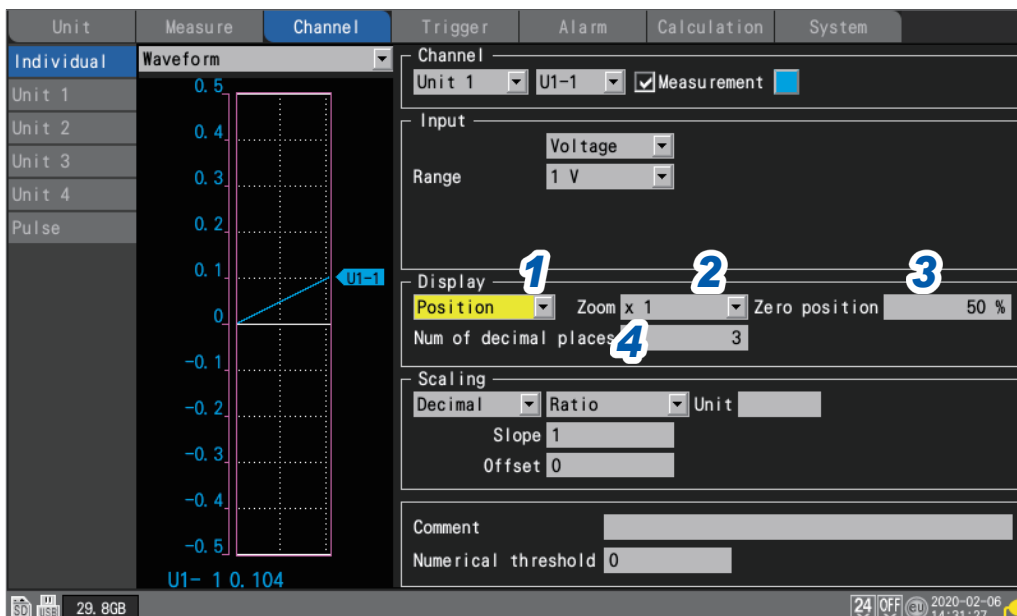

- 1 Select **[Position]** in the display settings.
- 2 Under **[Zoom]**, select the waveform display zoom factor.

x1/2, x1, **x2, x5, x10, x20, x50, x100**

When the zoom factor is **[x1]**, the screen's vertical axis display range will be the same as full scale.

3 Under **[Zero position]**, set where to place the waveform's zero point (0 V, 0°C, etc.).

-50% to 150% (x1)

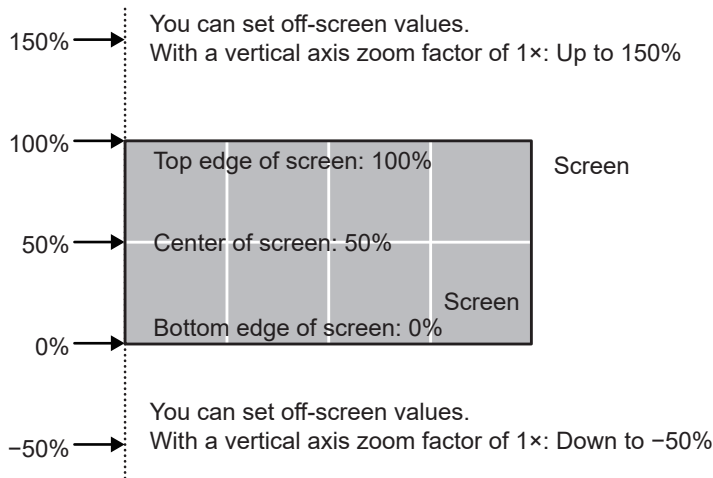

The range of available zero position settings will depend on the zoom factor.

4 (When using scaling, or when **[Number display format]** is set to a value other than **[Standard]**)
Under **[Num of decimal places]**, set the number of decimal places to use for measured values.

0, 1, 2, 3 , 4, 5, 6, 7, 8, 9, 10



When using scaling, a large number of decimal places, for example 5, may be used. If you wish to reduce the number of decimal places, set **[Num of decimal places]** to a small value.
Example: 1.23456 mV → 1.23 mV (when **[Num of decimal places]** is set to **[2]**)

Example: Waveform from -5 V to +5 V

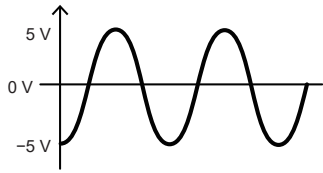

With voltage axis zoom factor of 1×
Zero position setting range: -50% to 150%

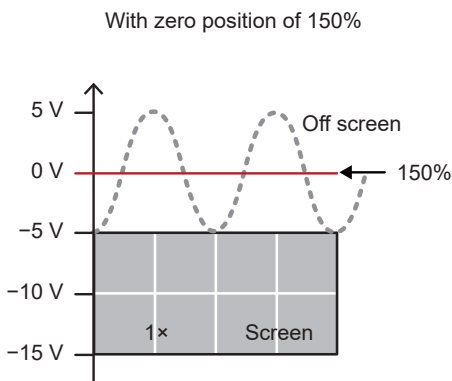
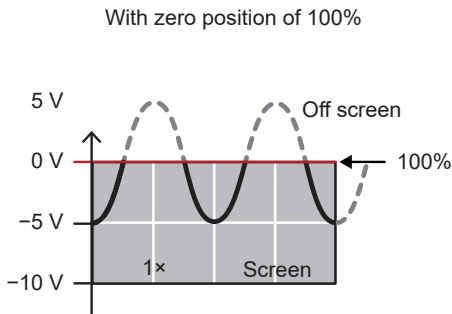
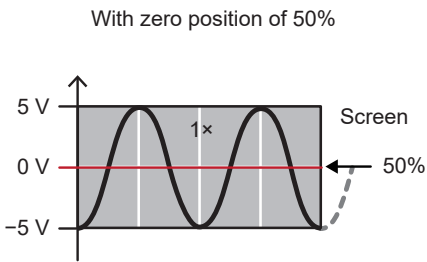
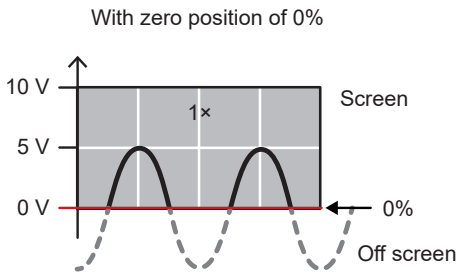

With voltage axis zoom factor of 2×
Zero position setting range: -150% to 250%

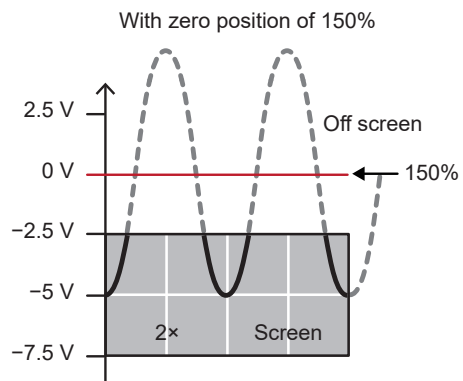
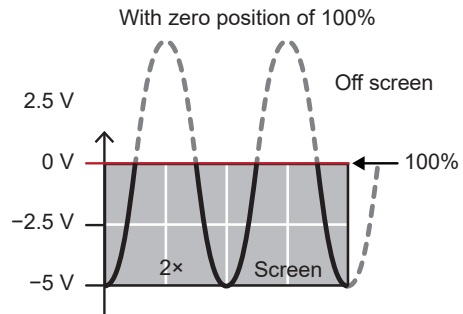
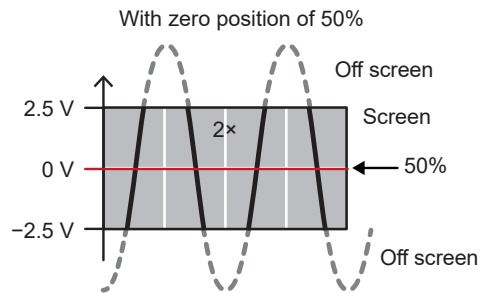
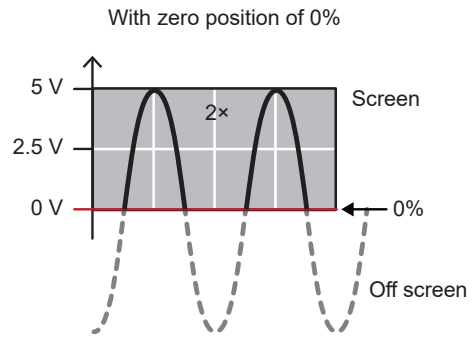

Setting upper and lower limit values

You can set the waveform's display range by specifying upper and lower limit values for the screen. Since you can specify any desired range, you can enlarge the waveform to show only the necessary portion.

Setting upper and lower limit values is also useful when using the scaling function.

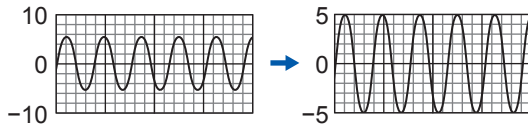

SET

Channel

Individual

- 1** Select **[Upper/Lower]** in the display settings.
- 2** Set the screen's upper limit value in **[Upper]**.
See "Value entry method" (p.7).
- 3** Set the screen's lower limit value in **[Lower]**.
See "Value entry method" (p.7).

Other display settings

This section describes how to change the display's zoom factor in the horizontal axis direction. This feature allows you to view fine-grained changes by enlarging the waveform or check the overall state by shrinking the waveform.

You can configure the horizontal axis display and set the method used to display vertical axis values.

SET > **Measure** > **Display**

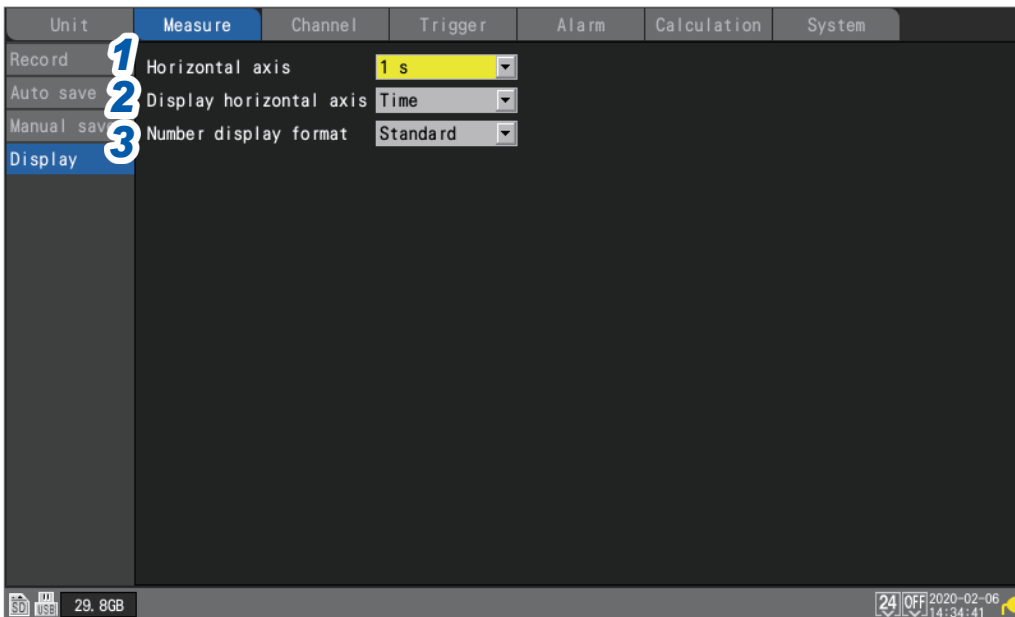

1 Under **[Horizontal axis]**, select the time per division.

You can select any time settings longer than the recording interval.

2 ms, 5 ms, 10 ms, 20 ms, 50 ms, 100 ms, 200 ms, 500 ms, 1 s , 2 s, 5 s, 10 s, 20 s, 30 s, 1 min, 2 min, 5 min, 10 min, 20 min, 30 min, 1 h, 2 h, 5 h, 10 h, 12 h, 1 d

Setting a shorter time enlarges the waveform.
 Setting a longer time shrinks the waveform.
 Since the time assigned to 1 division is a display setting, the recording interval and data refresh interval are unaffected.

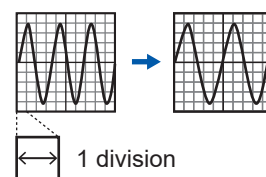

Restrictions during measurement

During measurement, the time per division setting has the upper limit according to the recording interval.

- Recording interval of 1 ms to 5 ms: Settings up to 10 min. will be available.
 If you start measurement after selecting a setting of 20 min. or greater, the setting will be changed to 10 min.
- Recording interval of 10 ms to 50 ms: Settings up to 1 h will be available.
 If you start measurement after selecting a setting of 2 h or greater, the setting will be changed to 1 h.
- Recording interval of 100 ms to 500 ms: Settings up to 10 h will be available.
 If you start measurement after selecting a setting of 12 h or greater, the setting will be changed to 10 h.

- 2** Under **[Display horizontal axis]**, select the display format to use for time values (horizontal-axis values) displayed on the screen.

Time <input checked="" type="checkbox"/>	Displays the time elapsed since the start of measurement. When using a trigger, the time elapsed since the trigger activation time will be displayed.
Date	Displays the actual time (date and time) every 10 divisions.
Data points	Displays the number of data points since the start of measurement. When using a trigger, the number of data points from the trigger activation time will be displayed.

This setting also applies when displaying time values for waveform data saved in the CSV format.

- 3** Under **[Number display format]**, select the display format to use for measured values (vertical-axis values).

Standard <input checked="" type="checkbox"/>	Displays measured values using the same SI prefix as the range. Example: 0.01234V (when using the 1 V range)
Decimal	Displays measured values as decimals. Example: 0.012V (when the number of decimal places is set to 3)
Exponent	Displays measured values as exponents. Example: 1.234E-02V (when the number of decimal places is set to 3)
Prefix	Displays measured values using an SI prefix. Example: 12.345mV (when the number of decimal places is set to 3)

When setting the horizontal axis on the waveform screen

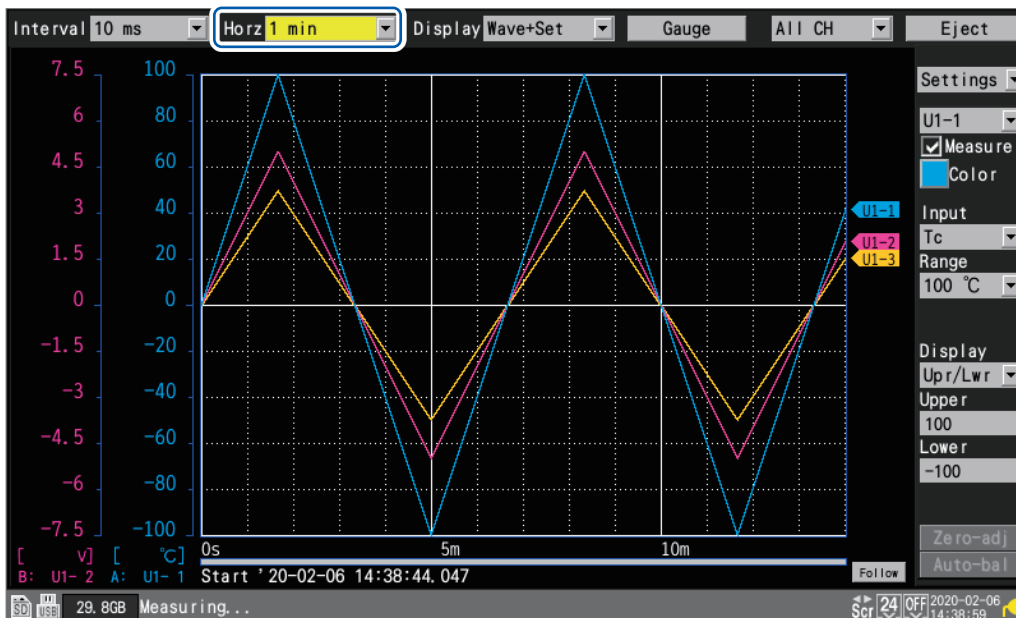

Under **[Horz]**, you can select the time per division. This setting can be changed while measurement is in progress.

1.5 Using the Scaling Function

This section describes how to use the scaling function to convert voltage values measured by the instrument into the measurement target's physical properties (current, temperature, etc.) and then display or record them.

Converted values can be displayed using decimal or scientific notation.

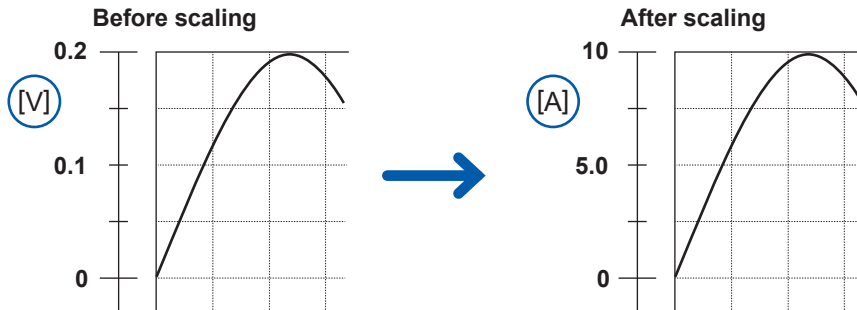

SET > **Channel** > **Individual**

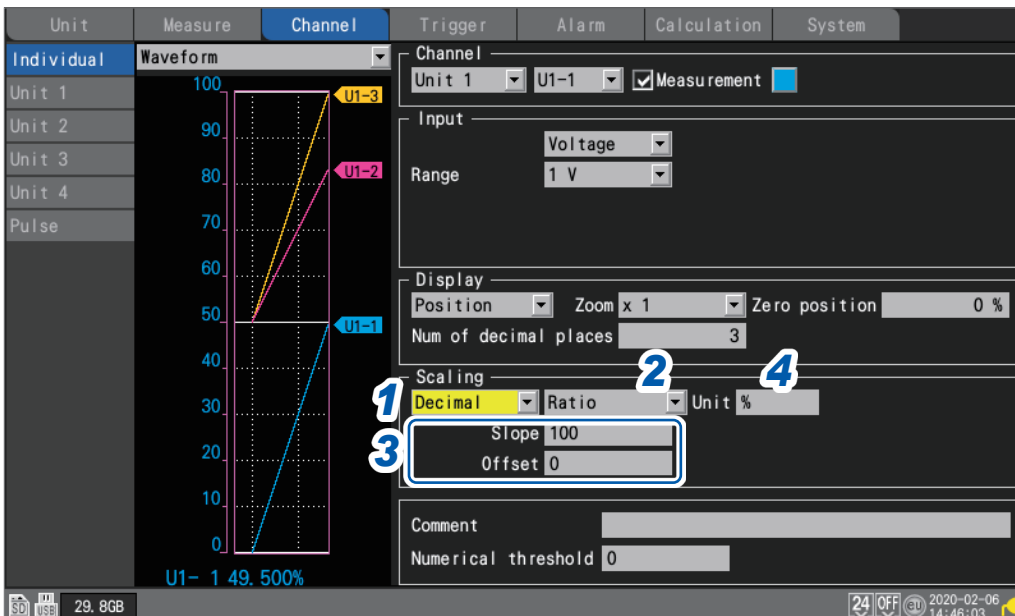

1 Select the scaling display method.

OFF <input checked="" type="checkbox"/>	Does not use the scaling function.
Decimal	Displays converted values as decimals.
Exponent	Displays converted values as exponents.

2 Select the scaling conversion method.

Ratio <input checked="" type="checkbox"/>	Sets the physical quantity (conversion ratio) per 1 V of input signal and the offset.
2-point	Sets converted values for two input signal voltage values.
Sensitivity	Sets the sensitivity constant for a heat flow sensor or actinometer.
Rating	Sets the rated capacity and rated output according to values in the inspection results sheet for the strain gage-type converter. (Setting available when using the U8554/LR8534 Strain Unit)

The conversion method cannot be selected for pulse integration measurement.
See "Scaling settings during integration measurement" (p.45).

3 (When the scaling conversion method is set to [Ratio])

Enter the slope and the offset in [Slope] and [Offset], respectively.

Select the numerical value entry item and press the **ENTER** key to display the numerical value setting window.

See "Value entry method" (p.7).

-9.9999e+09 to +9.9999e+09

Example setting

Make measurements using a strain* acceleration sensor with a calibration coefficient of $0.001442\text{G} / 1 \times 10^{-6}$ and display waveform data as values expressed in units of gees (G) (*: 10^{-6} strain = $\mu\epsilon$):

Unit	G
Slope	0.001442 (G) (displayed as 1.442 m)
Offset	0

4 Enter the post-conversion unit in [Unit] (up to 7 single-byte characters).

See "Text entry method" (p.8).

5 (When the scaling conversion method is set to [2-point])

Enter the pre- and post-conversion values in [Convert 1] and [Convert 2], respectively.

Select the numerical value entry item and press the **ENTER** key to display the numerical value setting window.

-9.9999e+29 to +9.9999e+29

Example setting

Convert 4-20 mA output from a sensor into 0 to 100 mm.

The 4-20 mA output is measured as 1 V to 5 V using a 250 Ω shunt resistor.

Convert a range of 1 V to 5 V into that of 0 mm to 100 mm.

Unit	mm
Convert 1	Convert 1 into 0 (1 V into 0 mm).
Convert 2	Convert 5 into 100 (5 V into 100 mm).

6 (When the scaling conversion method is set to [Sensitivity])

Enter the sensitivity value in [Sensitivity].

Select the numerical value entry item and press the **ENTER** key to display the numerical value setting window.

-1.0000e+09 to +1.0000e+09

Example setting

Make measurements using a heat flow sensor with a sensitivity constant of $0.02421\text{ mV/W}\cdot\text{m}^{-2}$ and display waveform data as values expressed in units of watts per square meter (W/m^2):

Unit	W/m^2
Sensitivity	0.02421 m (displayed as 24.21 μ)
Offset	0

7 (When the scaling conversion method is set to [Rating])

(Available only when U8554 or LR8534 Strain Unit is used)

Enter the rated capacity and rated output in [Capacity] and [Output], respectively.

Set the rated capacity and rated output ($\mu\text{V}/\text{V}$) according to values in the inspection results sheet for the strain gage-type converter.

Enter the rated capacitance unit as the unit.

Select the numerical value entry item and press the **ENTER** key to display the numerical value setting window.

+1.0000e-09 to +9.9999e+09

Example setting

If you wish to display measured results obtained using an acceleration sensor with a rated capacity of 20 G and rated output of 1000 $\mu\text{V}/\text{V}$ as values expressed in units of gees (G):

Unit	G
Capacity	20
Output	1000 (displayed as 1k)

You can use [Scaling] on the settings list screen to configure the settings.

See "1.7 Configuring Channels in a List" (p.50).



- Setting the display position (upper and lower limit values)
When using the scaling function, configure scaling before setting the upper and lower limit values.
See "Setting upper and lower limit values" (p.39).
- Setting of the number of display digits
You can set the number of display digits when the scaling display setting is set to [Decimal].
(Default setting: three decimal places)
See "Configuring the display of the vertical axis" (p.36).
- Reviewing pre-conversion waveforms
When you save waveform data in the binary format, raw data (data prior to the scaling conversion) and scaling settings are recorded. Loading waveform data allows waveforms after the scaling conversion to be displayed. You can review the pre-conversion waveforms if you turn off the scaling setting.

Scaling settings during integration measurement

You can use the scaling function to convert the integrated pulse count to the measurement target's physical properties (watt hours, volt-amperes, etc.) and then display or record the result.

The pulse output device will have predetermined physical quantity that corresponds to 1 pulse or a number of pulses that corresponds to a value of one in the basic units (for example, 1 kWh, 1 L, 1 m³).

SET > Channel > Individual

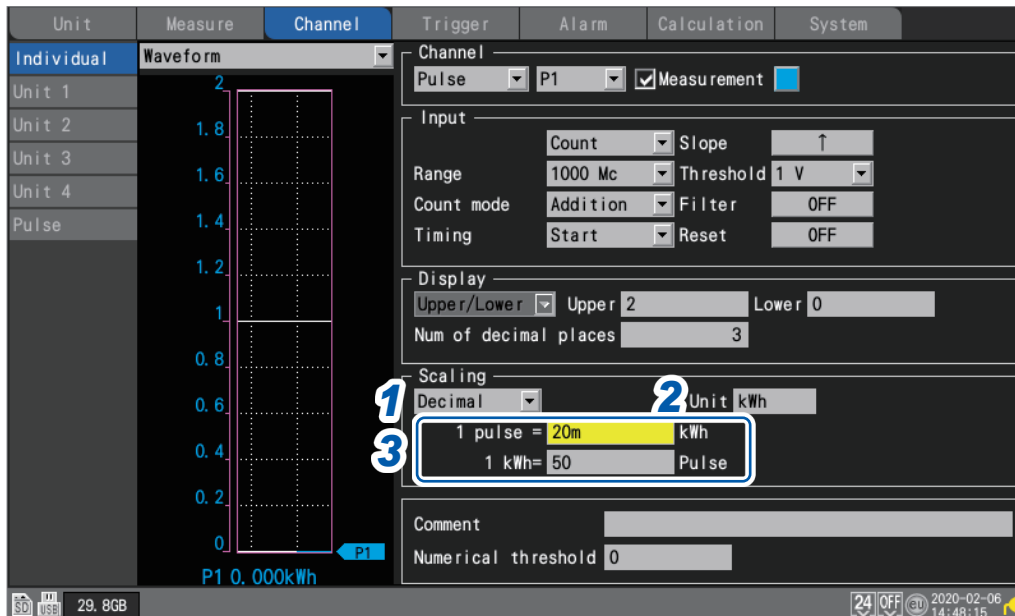

1 Select the scaling display method.

OFF <input checked="" type="checkbox"/>	Does not use the scaling function.
Decimal	Displays converted values as decimals.
Exponent	Displays converted values as exponents.

2 Enter the post-conversion unit (up to 7 single-byte characters).

See "Text entry method" (p.8).

3 Enter physical quantity per pulse or the number of pulses (example: 1 c = 1 pulse) that corresponds to a value of one in the basic units.

Select the numerical value entry item and press the **ENTER** key to display the numerical value setting window.

The settings that define the physical property per pulse and the number of pulses corresponding to a value of one in the basic units are linked.

Example setting

When connecting a watt-meter with 50,000 pulses per kWh and integrating its output

Scaling	Decimal
Unit	kWh
1 kWh	50000 (number of pulses per kWh)

When connecting a flowmeter with 10 L per pulse and integrating its output

Scaling	Decimal
Unit	L
1 pulse	10 (flow rate [L] per pulse)



1.6 Entering Comments

This section describes how to enter measurement titles, channel comments, and module identifiers.

Title comments

This section describes how to enter a string of text to serve as the measurement title. (Up to 40 single-byte characters)
See “Text entry method” (p.8).

Title comments are displayed at the top of the waveform screen.
You can use title comments to identify measurement based on image data when display screenshots are saved.

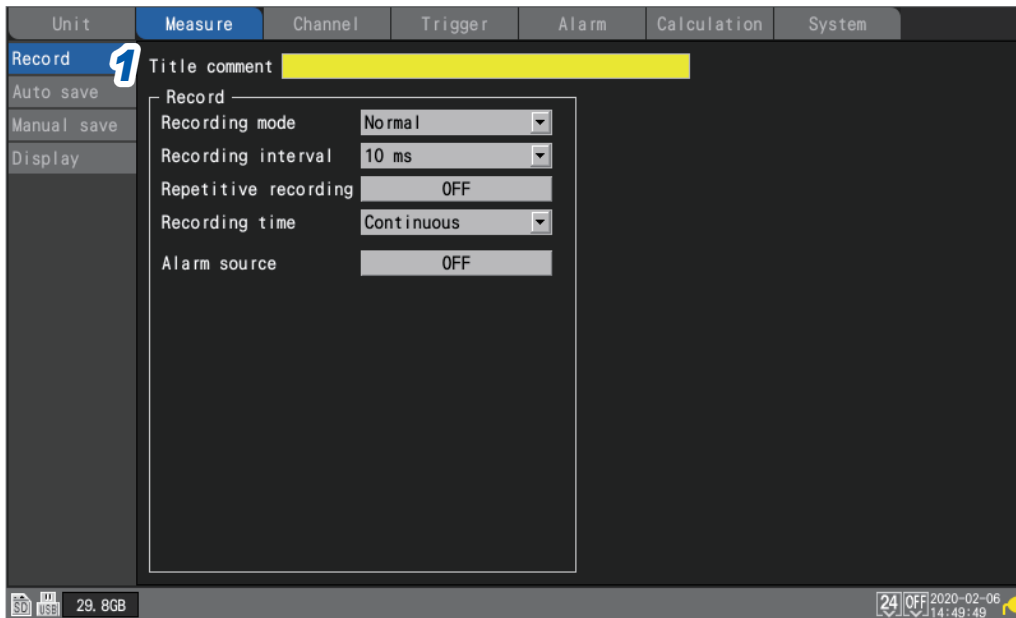
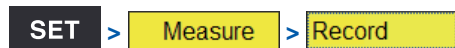

- 1** Select [Title comment] with the **Left Arrow**, **Right Arrow**, **Up Arrow**, and **Down Arrow** keys and press the **ENTER** key.

The text entry window will open.
See “Text entry method” (p.8).

- 2** Enter text and press the **ENTER** key.

The entered text will be accepted.

Channel comments

This section describes how to enter a string of text for each channel. (Up to 40 single-byte characters)
 See “Text entry method” (p.8).

Channel comments are displayed on the screen when the waveform screen is set to **[Wave+Value]**.
 Channel comments allow you to identify channels when measuring numerous channels.

SET > **Channel** > **Individual**

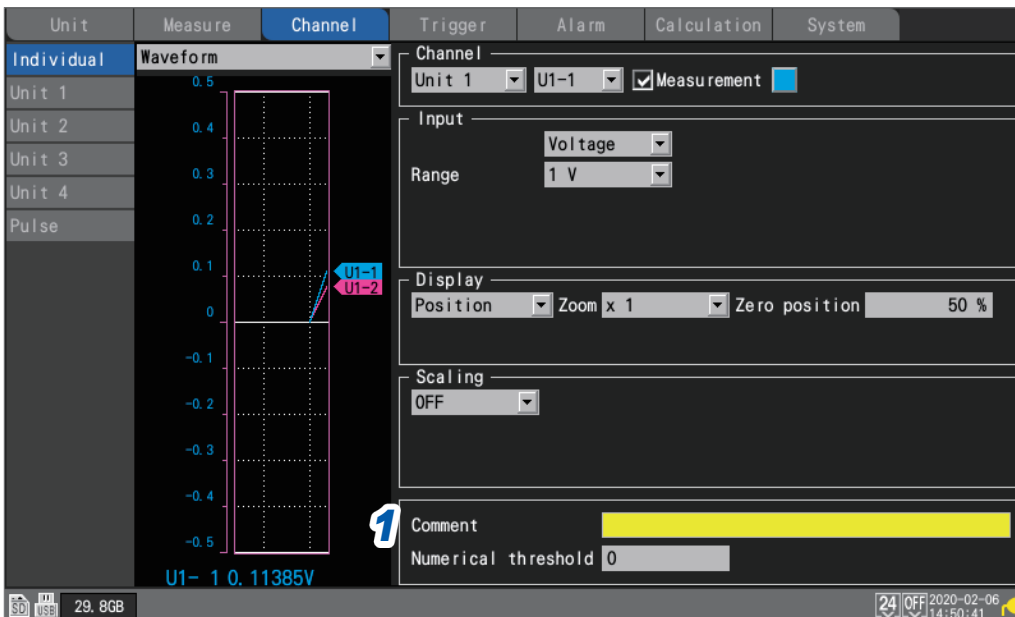

- 1** Select **[Comment]** with the **Left Arrow**, **Right Arrow**, **Up Arrow**, and **Down Arrow** keys and press the **ENTER** key.

The text entry window will open.
 See “Text entry method” (p.8).

- 2** Enter text and press the **ENTER** key.

The entered text will be accepted.

You can use **[Comment]** on the settings list screen to enter channel comments.
 See “1.7 Configuring Channels in a List” (p.50).

Module identifiers

This section describes how to enter an identifier (string of text) for each module. (Up to 8 double-byte or 16 single-byte characters)
See “Text entry method” (p.8).

You can use module identifiers to identify modules when using multiple modules.

SET > **Unit**

Unit No.	Model	CH	Name	Serial No.	Status	Update	Filter	Unit identifier
Unit 1	U8550	15ch	Voltage/Temp	100000019		Auto	20.8 kHz	ABCDEFGHIJKLMNO
Unit 2	U8552	30ch	Voltage/Temp	100000229		Auto	20.8 kHz	abcdefghijklmno
Unit 3	U8554	5ch	Strain	100000422		1 ms	120 Hz	
Unit 4	U8551	15ch	Universal	100000117		10 ms	20.8 kHz	
Remote 1								
Remote 2								
Remote 3								
Remote 4								
Remote 5								
Remote 6								
Remote 7								

- 1** Select [Unit identifier] with the **Left Arrow**, **Right Arrow**, **Up Arrow**, and **Down Arrow** keys and press the **ENTER** key.
The text entry window will open.
See “Text entry method” (p.8).
- 2** Enter text and press the **ENTER** key.
The entered text will be accepted.

1.7 Configuring Channels in a List

This section describes how to review module settings on the list.

SET > **Channel** > [Unit n] (n = 1, 2, ...)

Settings list screen: **[Input]**

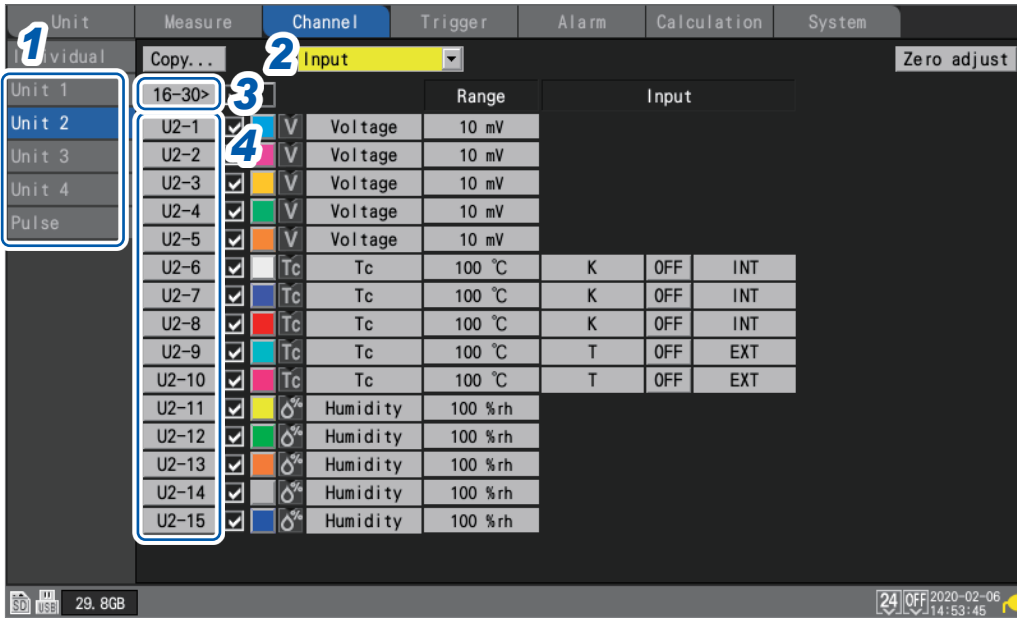

- 1 On the sub tab, select the module whose settings you wish to display in the list.
- 2 Select the item to display.

Input , **Display**, **Scaling**, **Comment**, **Numerical calc**

Settings list screen: **[Display]**

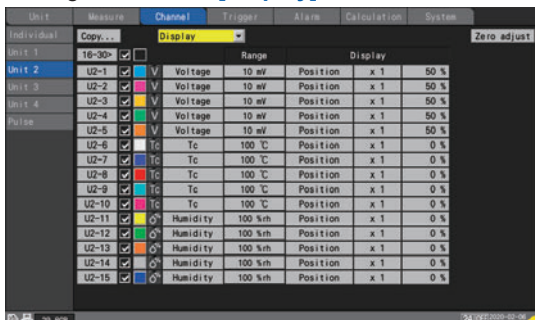

See "1.4 Configuring the Waveform Display" (p.36).

Settings list screen: **[Comment]**

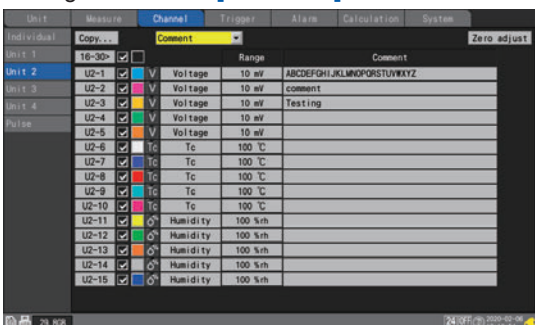

See "1.6 Entering Comments" (p.47).

Settings list screen: **[Scaling]**

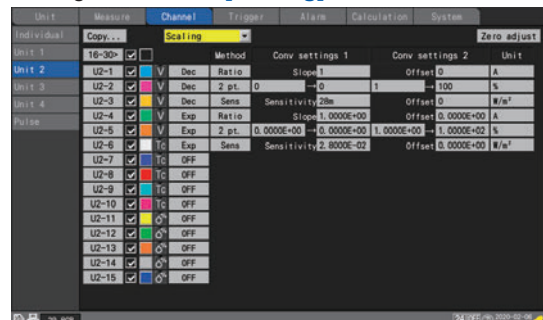

See "1.5 Using the Scaling Function" (p.42).

Settings list screen: **[Numerical calc]**



See "Configuring numerical calculations" (p.147).



3 (U8552, LR8532)

- Press the **ENTER** key while **[16-30>]** is selected to display CH16 to CH30.
- Press the **ENTER** key while **[1-15>]** is selected to display CH1 to CH15.

4 Select a channel number and press the ENTER key.

The individual settings window will open, allowing you to configure the settings. Press the **ESC** key to close the window.

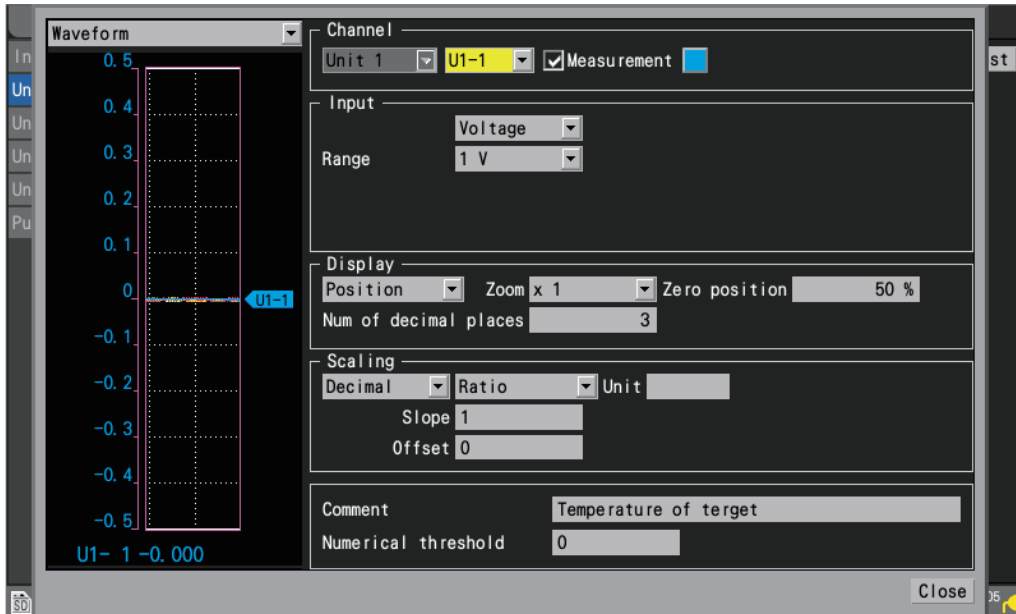

See “1.3 Configuring Input Channels” (p. 16).

Pulse settings list screen

SET > Channel > Pulse

Settings list screen: [Input]

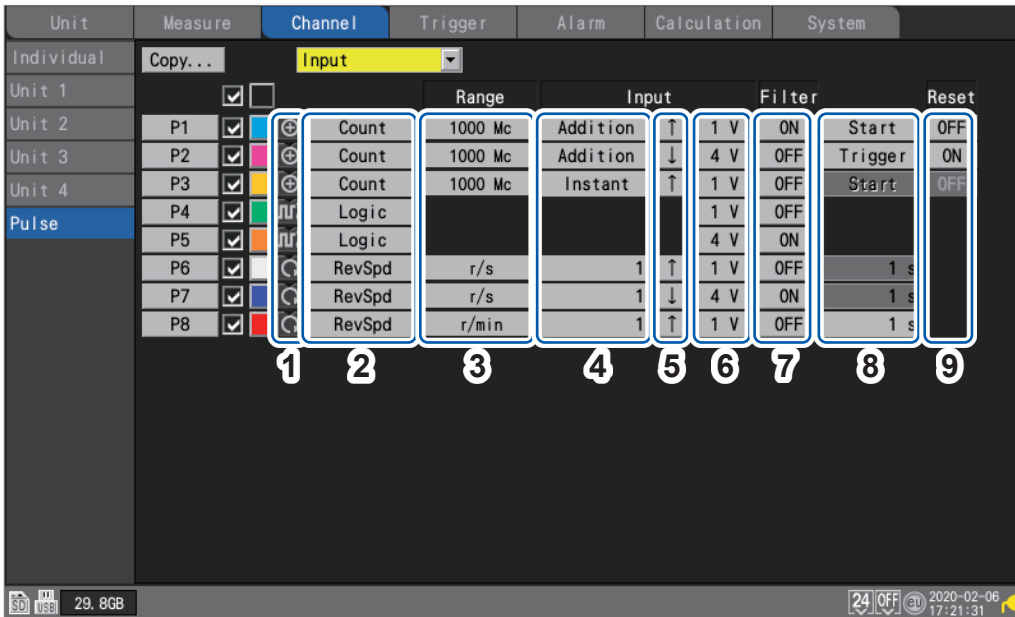

1		Input type: Integration
		Input type: Logic
		Input type: Rotational speed
2	Input type	Input type
3	Range	When the input type is [RevSpd]: Count reference time
4	Integration mode	When the input type is [Count]: Integration method
	Pulse count	When the input type is [RevSpd]: Number of pulses per revolution
5	Slope	Slope at which to count
6	Threshold value	Level at which to count
7	Filter	Chatter prevention filter
8	Timing	When the input type is [Count]: Timing at which to start counting
	Smoothing	When the input type is [RevSpd]: Processing period for smoothing
9	Reset	Operation to perform when the integrated value overflows

Settings list screen: **[Display]**

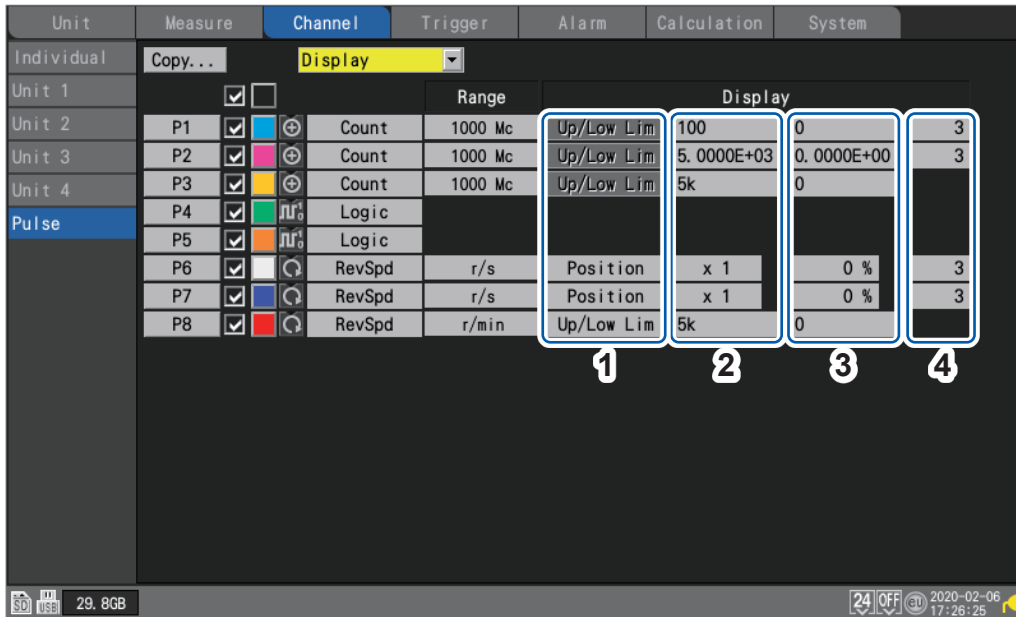

1	Display settings	Displays setting method
2	Zoom factor	When the display setting is [Position] : Waveform display zoom factor
	Upper limit value	When the display setting is [Up/Low Lim] : Screen upper limit value
3	Zero position	When the display setting is [Position] : Waveform zero position (0 V, 0°C, etc.)
	Lower limit value	When the display setting is [Up/Low Lim] : Screen lower limit value
4	Number of decimal places	Number of decimal places for measured values

Settings list screen: **[Scaling]**

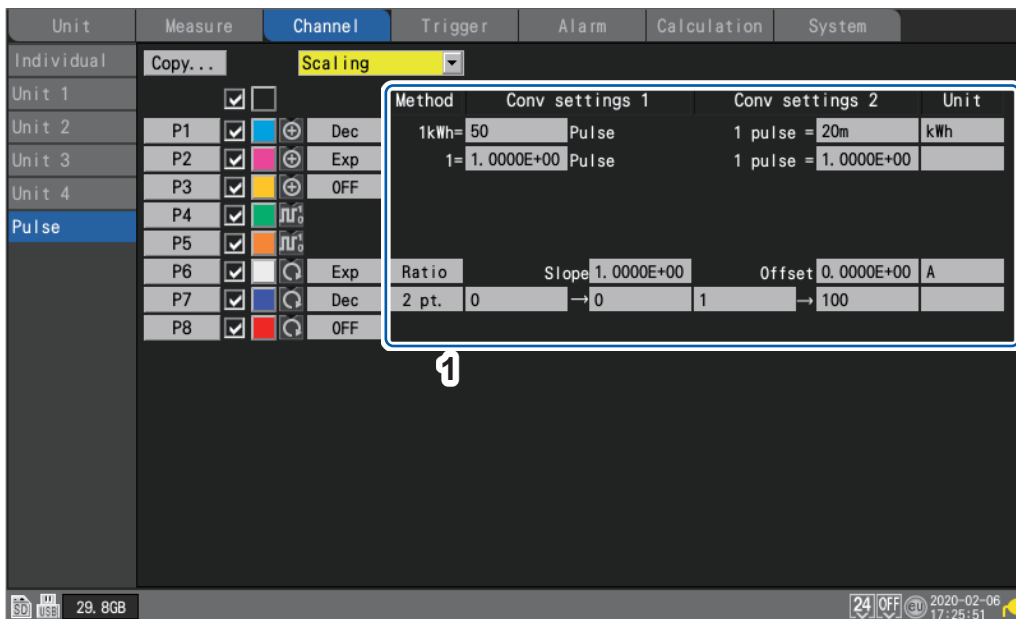

1	Scaling	Scaling settings
---	----------------	------------------

Settings list screen: **[Comment]**

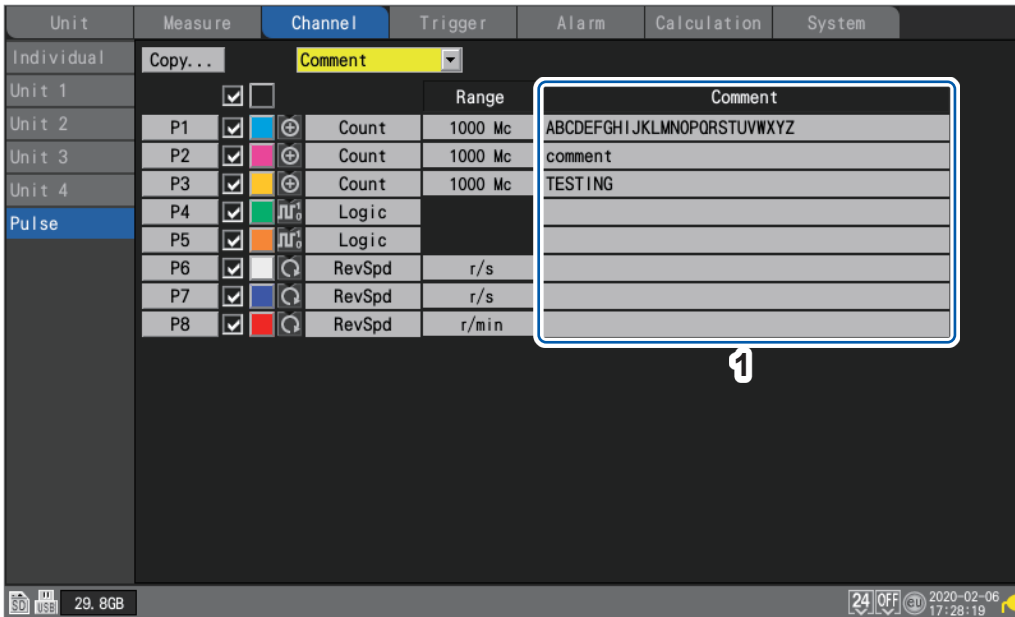

1	Comment	Comments for individual channels
----------	----------------	----------------------------------

Settings list screen: **[Numerical calc]**



1	Threshold value	Threshold value for numerical calculations (Availability, ON time, OFF time, ON count, OFF count)
----------	------------------------	--

Tips Threshold values will be used for numerical calculations. For more information about threshold values, see “Configuring numerical calculations” (p. 147).

Copying channel settings

This section describes how to copy one module's settings to another module.

SET > **Channel** > **[Unit n]** (n = 1, 2, ...)

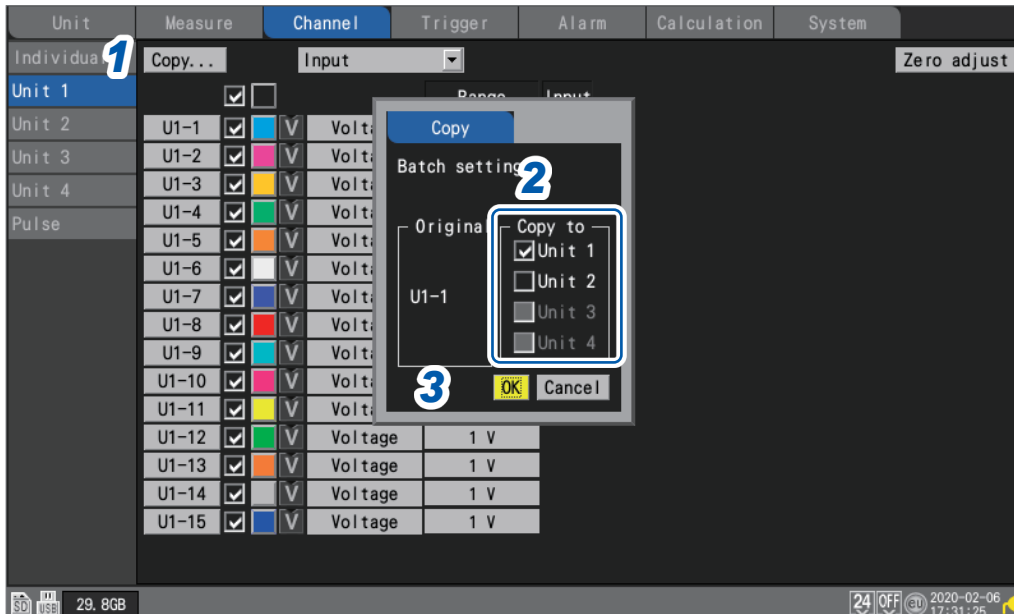

- 1** Press the **ENTER** key while **[Copy...]** is selected.
The settings window will open.
- 2** Select the checkbox for the module to which you wish to copy the settings (the target module).
The source module cannot be changed from **[Un-1]**. (n = 1, 2, ...)
- 3** Select **[OK]** and press the **ENTER** key.
The settings will be copied.
Pressing the **ENTER** key while **[Cancel]** is selected to cancel the copy operation.

Configuring channel settings at once

This section describes how to turn the measurement on or off and configure the waveform display color settings for all channels on a module.

SET > **Channel** > **[Unit n]** (n = 1, 2, ...)

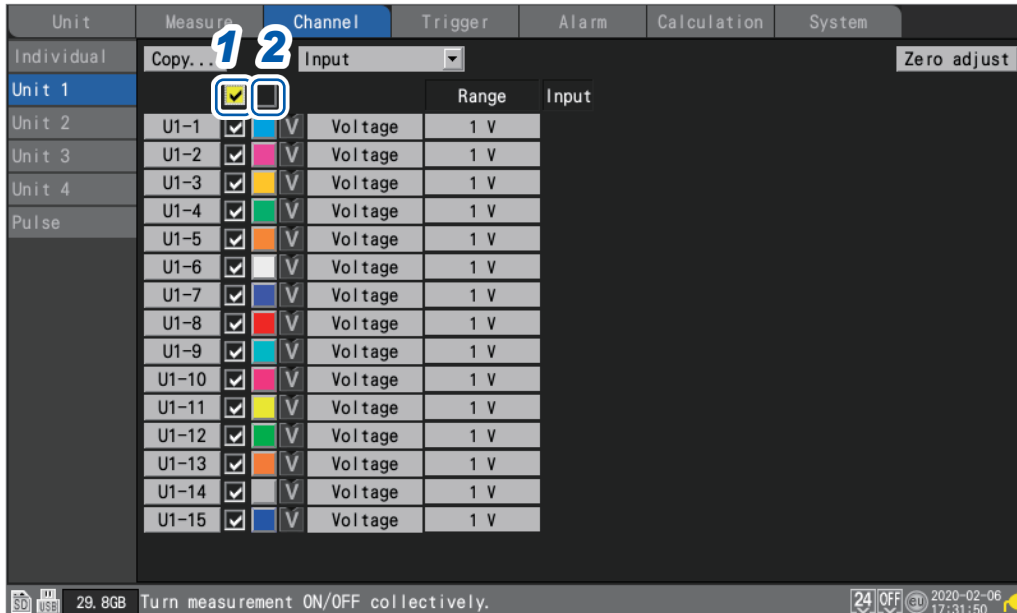

1 Select the measurement ON/OFF checkbox and press the **ENTER** key.

Each time you press the **ENTER** key, the measurement setting for all channels will toggle between ON and OFF.

2 Select the measurement display color checkbox and press the **ENTER** key.

Each time you press the **ENTER** key, the display setting for all channels will toggle between ON and OFF.

1.8 Performing Zero Adjustment

This section describes how to correct misalignment of inputs and set the instrument's reference voltage to 0 V.

Perform zero adjustment if the reference voltage is not 0 V with a pair of input terminals short-circuited.

Zero adjustment is performed as follows:

- 1 Press the **ENTER** key while **[Zero-adj]** is selected on the waveform screen.



Zero adjustment values are reset when a system reset is performed. Zero adjustment cannot be performed while measurement is in progress.

Tips The internal temperature of the instrument and modules will stabilize once at least 30 minutes has elapsed since they were turned on. Temporal variation can be limited by performing zero adjustment in this state.

The zero adjustment function is disabled for Strain Units (U8554, LR8534). To adjust the zero position of Strain Units, use the auto-balancing function. For more information about auto-balancing, see "Measuring strain" (p.27).

Zero adjustment can also be performed on the settings list screen.

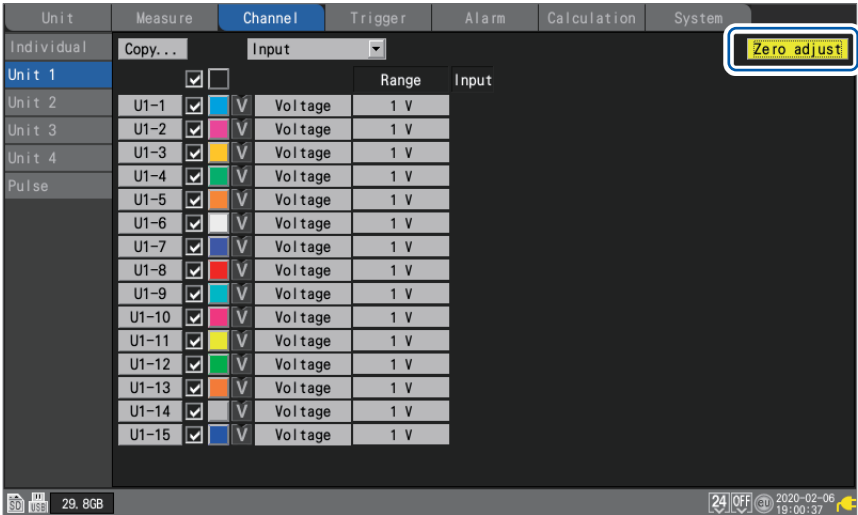

1.9 Checking Input Signals (Monitor Function)

This section describes how to check input waveforms to verify that settings such as the range and display range have properly been configured before starting measurement.

Press the **MONITOR** key to display waveforms and values on the monitor screen.

Data will be displayed on the screen but not saved in the instrument's internal buffer memory or on storage media.

(1) Setting the time per division

See "Under **[Horizontal axis]**, select the time per division." (p.40).

(2) Selecting the module to display

Waveforms for up to 166 channels can be displayed.

(Maximum number of channels: 120 analog, 8 pulse, 8 alarm, and 30 waveform calculation)

(3) Turning the gage on or off

You can choose the channels for which to display a gage.

(4) Switching the channels to display (for modules with 16 channels or more)

Values can be displayed for up to 15 channels on one screen.

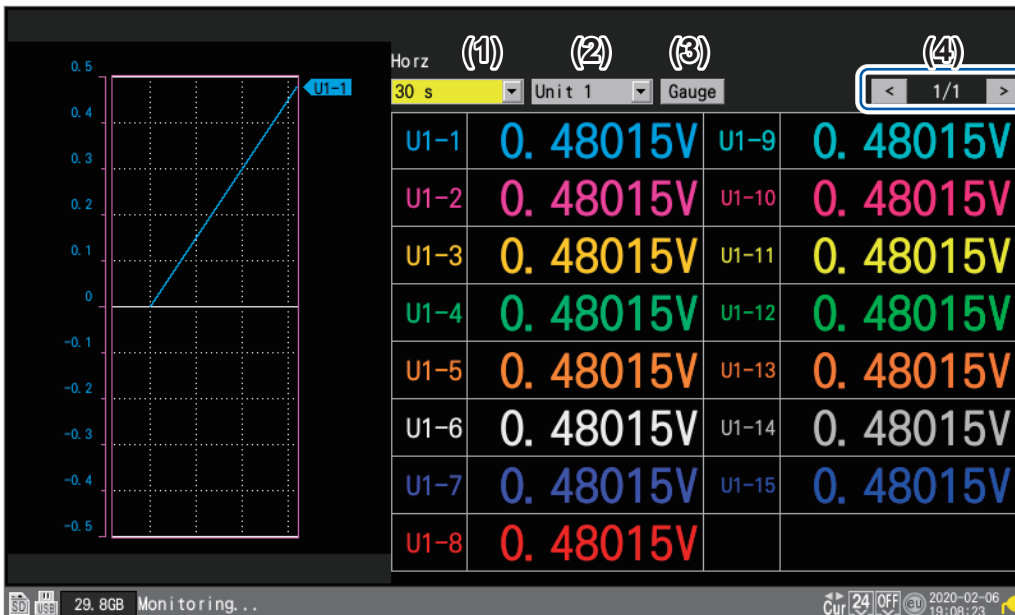

The monitor function will terminate when you change the screen display or start measurement.

- The monitor function cannot be used while measurement is in progress.
- For channels with more than 14 characters, text will be shown in a smaller size.

1.10 Starting and Stopping Measurement



Press the **START** key to start measurement.

When the **[System] > [Operation error prevention]** setting is **[ON]**, an operation confirmation window will be displayed. Press the **ENTER** key while **[Yes]** is selected to start measurement.

Starting measurement after stopping it will cause the measurement data in the instrument's internal buffer memory to be deleted. Save important data on an SD Memory Card or USB Drive before starting measurement again.



Press the **STOP** key to stop measurement.

When the **[System] > [Operation error prevention]** setting is **[ON]**, an operation confirmation window will be displayed. Press the **ENTER** key while **[Yes]** is selected to stop measurement.

Tips

- Measurement can also be stopped automatically at the set recording time. See "1.2 Setting Measurement Conditions" (p. 10).
- You can prevent misoperation of the **START** and **STOP** keys. See "7.1 Configuring Settings" (p. 164).
- You can start recording operation when specific conditions occur. This functionality is convenient when you wish to monitor conditions for anomalies. See "2 Trigger Function" (p. 81).

Measurement operation

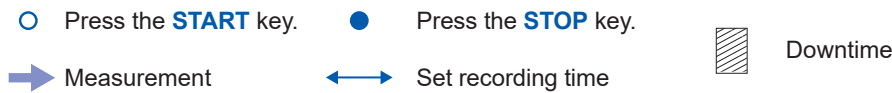

Recording time	Repeat recording: OFF	Repeat recording: ON
Time specified (STOP key not pressed)		
Time specified (If the STOP key is pressed while measurement is in progress)		
Continuous recording		(Same as when repeat recording is OFF)

1.11 Observing Waveforms

Press the **WAVE** key to display the waveform screen. The waveform screen is displayed at all times while measurement is in progress.

The screen provides the following functionality:

- Moving (scrolling) waveforms
- Moving waveforms while measurement is in progress (to check past waveform data)
- Enlarging and shrinking waveforms
- Reading values from waveforms with the A/B cursors
- Displaying a gage (scale) on the left side of the screen
- Displaying comments on the right side of the screen

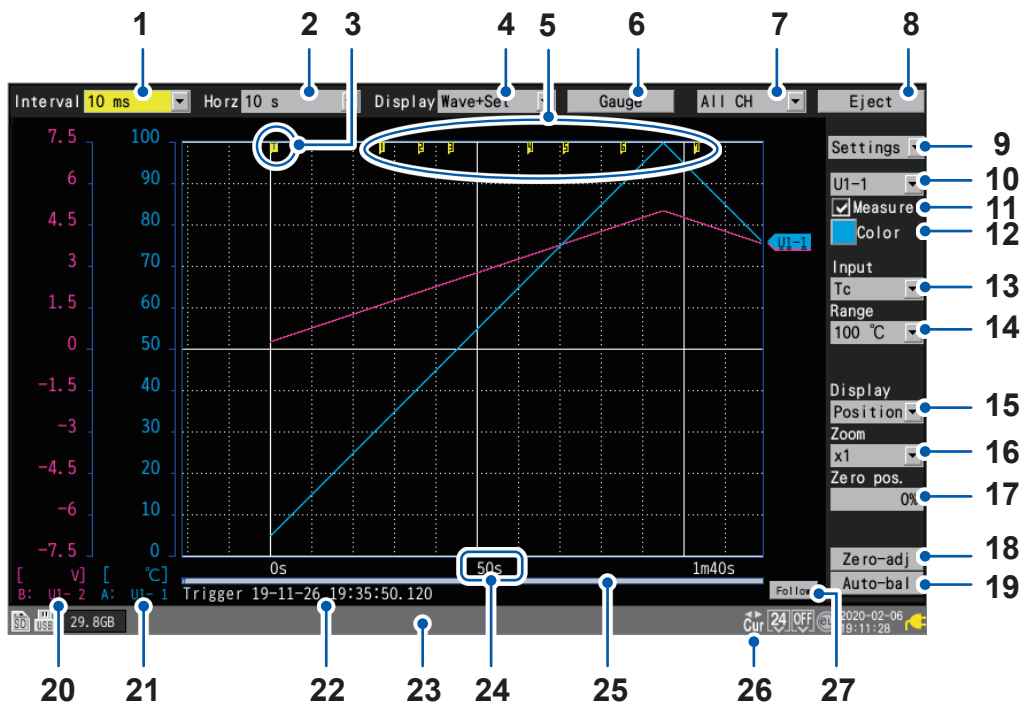

No.	Name	Description	Reference page
1	Recording interval	Allows you to select the interval at which the instrument captures data from the measurement module.	p. 11
2	Horizontal axis	Allows you to select the horizontal axis (time per division).	p.40
3	Trigger mark	Indicates the trigger points.	p.81
4	Screen	Allows you to select the waveform display method.	p.62
5	Event mark	Displays the event number.	p. 140
6	Gage	Allows you to configure the gage (scale) displayed on the left side of the screen.	p.65
7	Display selection	Allows you to select the waveforms displayed on the screen (sheet).	-
8	Eject	Allows you to eject external media.	p. 111
9	Setting selection	Allows you to select the settings displayed on the right side of the screen.	-
10	Channel selection	Allows you to select the channel to configure.	-

No.	Name	Description	Reference page
11	Measurement	Allows you to turn measurement on or off.	p. 19
12	Waveform color	Allows you to select the waveform display color.	p. 19
13	Input type	Allows you to select the type of input.	p. 16
14	Range	Allows you to select the range.	p. 16
15	Display position	Allows you to select the waveform display position.	p. 36
16	Zoom factor	Allows you to select the zoom factor in the voltage axis direction.	p. 36
17	Zero position	Allows you to set the waveform's display position (zero position).	p. 36
18	Zero adjustment	Allows you to perform zero adjustment.	p. 57
19	Auto-balancing	Allows you to perform auto-balancing (Strain Units only).	p. 28
20	Gage B	Indicates the channels and modules displayed using gage B.	p. 65
21	Gage A	Indicates the channels and modules displayed using gage A.	p. 65
22	Trigger time	Indicates the time and date at which the trigger was activated.	–
23	Status bar	Displays the time and date, messages, icons* ¹ , and other information.	–
24	Time value	Displays the time from the measurement start.* ²	–
25	Scroll bar	Indicates the displayed waveform's range and position.	p. 71
26	Scroll icon	 The waveform is moved using the SCROLL/CURSOR keys.	p. 69
	Cursor icon	 The A/B cursors are moved using the SCROLL/CURSOR keys.	p. 75
27	Follow	The most recent waveform is always displayed using the auto-scroll function.	–

*1: For more information about icons other than the scroll and cursor icons, see “Screen and icons” in “1.2 Part Names and Functions; Screens” in the Quick Start Manual.

*2: The waveform screen, value screen, and warning screen of the instrument express minute, a unit of time, in terms of the letter *m* instead of *min*.

Waveform display

This section describes how to change the method used to display measured waveforms.

Under **[Display]**, select the waveform display method.

Wave+Set, Wave, Wave+Value, Value, Alarm

You can also select the display method with the **WAVE** key.

Each time you press the **WAVE** key, the display will cycle to the next display method.

[Wave+Set]

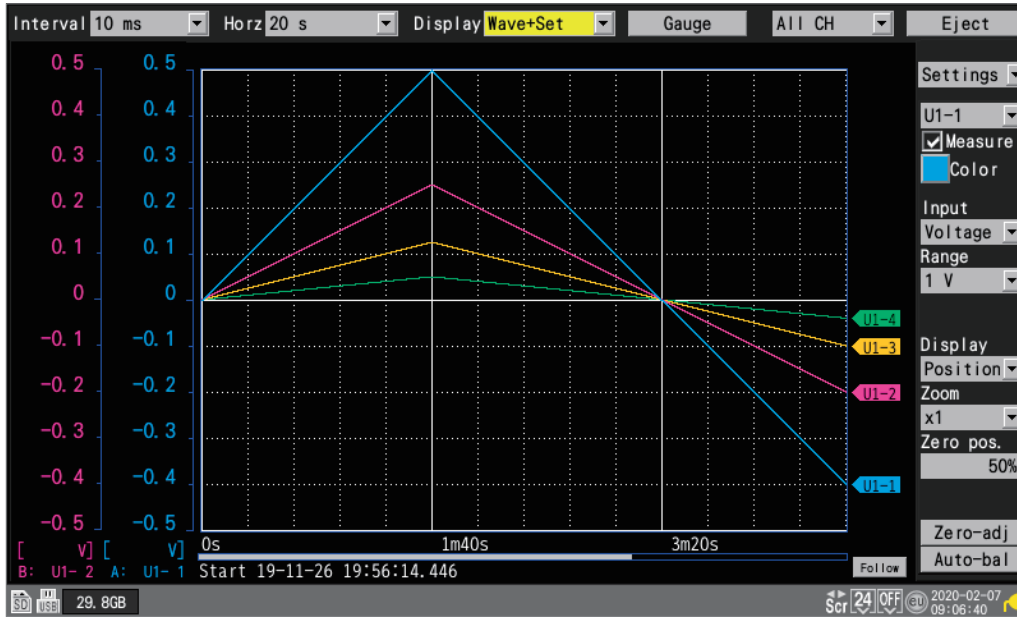

[Wave]

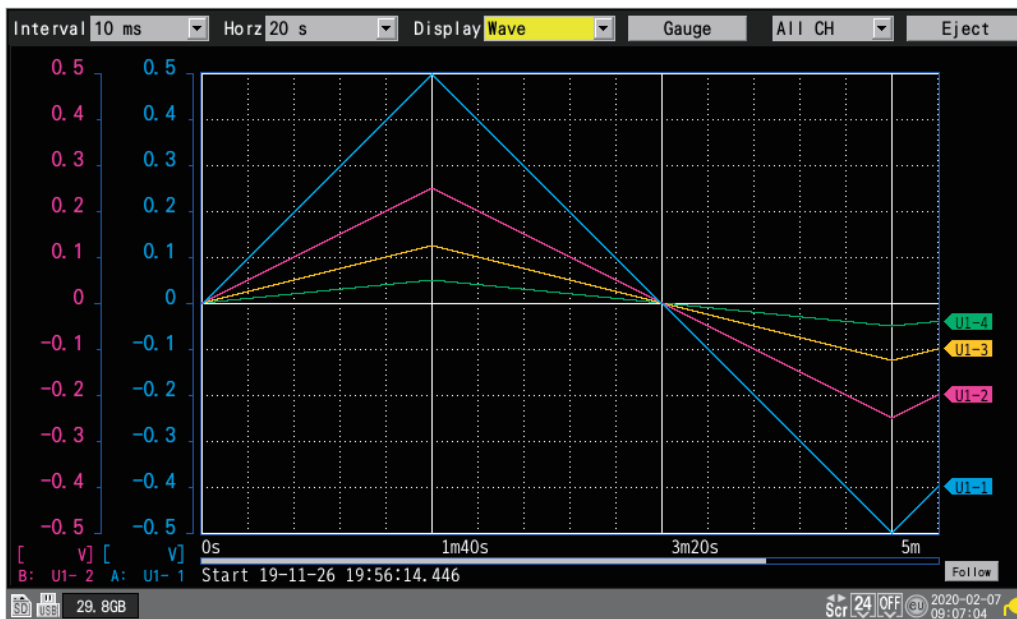

[Wave+Value]



[Value]

Ch	6m57.760s	MAX	MIN	AVE	P-P
U1-1	0.08880V	0.50000V	-0.50000V	0.00189V	1.00000V
U1-2	0.08880V	0.50000V	-0.50000V	0.00189V	1.00000V
U1-3	0.08880V	0.50000V	-0.50000V	0.00189V	1.00000V
U1-4	0.08880V	0.50000V	-0.50000V	0.00189V	1.00000V
U1-5	0.08880V	0.50000V	-0.50000V	0.00189V	1.00000V
U1-6	0.08880V	0.50000V	-0.50000V	0.00189V	1.00000V
U1-7	0.08880V	0.50000V	-0.50000V	0.00189V	1.00000V
U1-8	0.08880V	0.50000V	-0.50000V	0.00189V	1.00000V
U1-9	0.08880V	0.50000V	-0.50000V	0.00189V	1.00000V
U1-10	0.08880V	0.50000V	-0.50000V	0.00189V	1.00000V
U1-11	0.08880V	0.50000V	-0.50000V	0.00189V	1.00000V
U1-12	0.08880V	0.50000V	-0.50000V	0.00189V	1.00000V
U1-13	0.08880V	0.50000V	-0.50000V	0.00189V	1.00000V
U1-14	0.08880V	0.50000V	-0.50000V	0.00189V	1.00000V
U1-15	0.08880V	0.50000V	-0.50000V	0.00189V	1.00000V

[Alarm]

Interval 10 ms Horz 20 s Display Alarm Gauge All CH Eject

Alarm ON
 Alarm hold ON
 Clear
 Buzzer ON

ALM1	ALM2	ALM3	ALM4	ALM5	ALM6	ALM7	ALM8
OR	OR	OR	OR	OR	OR	OR	OR

Display alarm All No. 1 Jump

No.	ALM	UNIT-CH	Error	Time of occurrence	Time of cancellation
1	ALM1	U1-1		0s	---
2	ALM2	U1-1		0s	---
3	ALM3	U1-1		1.010s	---

SD USB 29.8GB Measuring... Scr 24 OFF 30 2020-02-07 09:25:34

Gage (scale) display

This section describes how to display a gage (scale) for any channel on the left side of the screen. The gage can be used to check the waveform and its values.

Two gages (A and B) can be displayed.

You can choose the channels for which to display a gage. The gage will be shown in the same color as the selected channel.

WAVE

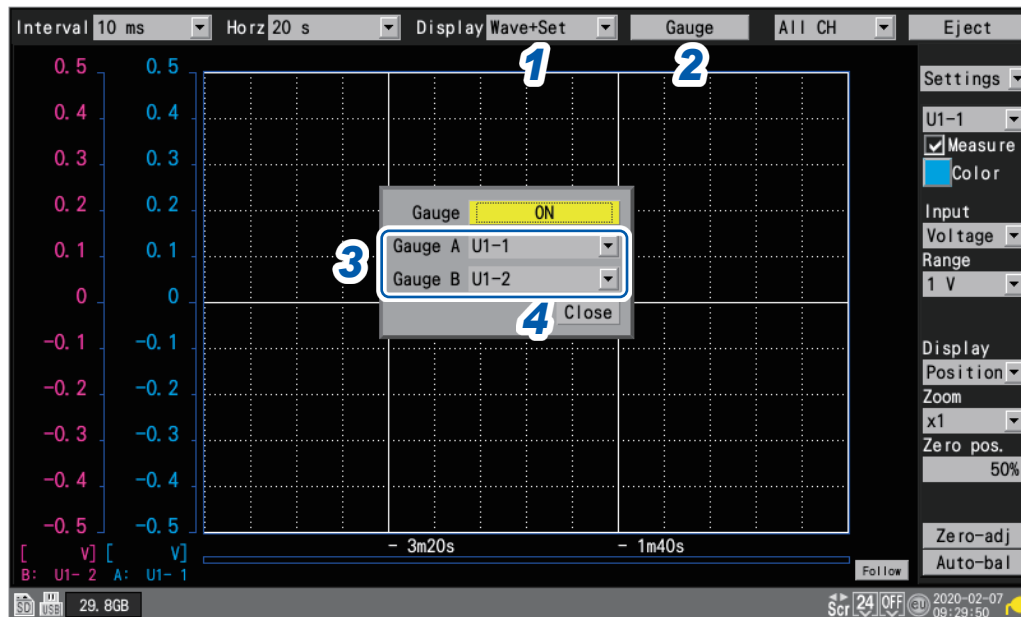

- 1** Under **[Display]**, set the display to **[Wave+Set]**, **[Wave]**, or **[Wave+Value]**.
- 2** Press the **ENTER** key while **[Gauge]** is selected.
The gage window will open.
- 3** Select the channels for gage A and gage B.
To cancel the settings, press the **ESC** key.
- 4** Press the **ENTER** key while **[Close]** is selected.
The window will close.

Numerical value display

This section describes how to select the numerical value display method.

[Value] screen

This screen displays only numerical values.



1 Select the value to display.

All	Instantaneous values, maximum values, minimum values, average values, and peak-to-peak values
Instant	Most recent measured value (INST)
Maximum	Maximum value (MAX) from the start of measurement to the current time
Minimum	Minimum value (MIN) from the start of measurement to the current time
Average	Average value (AVE) from the start of measurement to the current time
P-P	Difference between maximum and minimum value (peak-to-peak value) from the start of measurement to the current time

You can also select the value with the **SELECT** key.

To choose a setting other than **[All]**, press and hold the **SELECT** key to display comments.

2 Change the channel to display (as necessary) using the [**<**] and [**>**] keys on the top right of the screen.

[Wave+Value] screen

You can choose any of three types of information to display on the right side of the screen.

- (1) **Instantaneous:** Measured values most recently obtained or shown on the right portion of the waveform screen

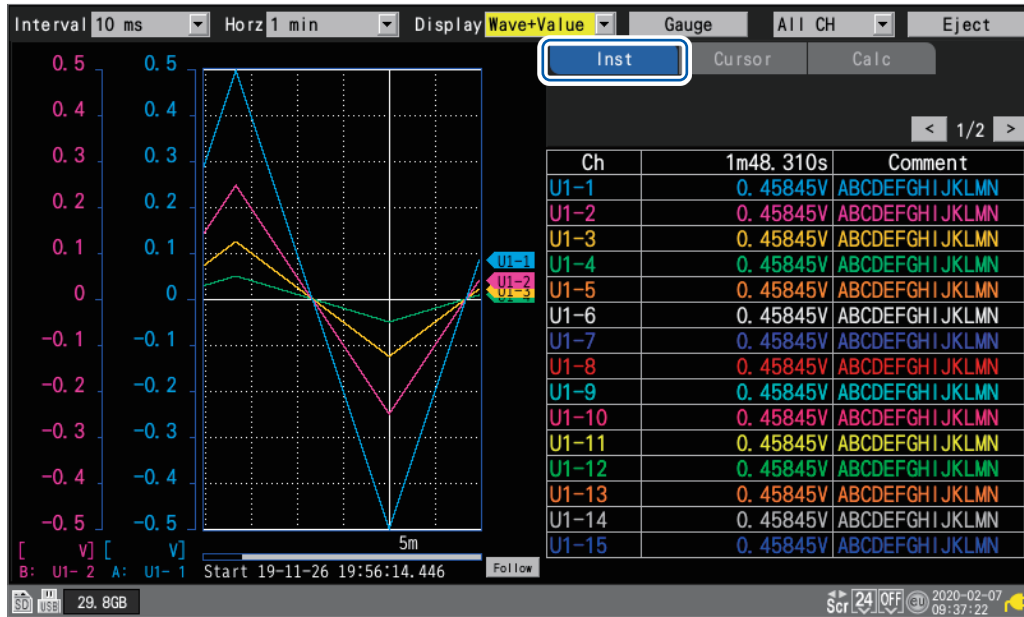

- (2) **Cursor:** A/B cursor values

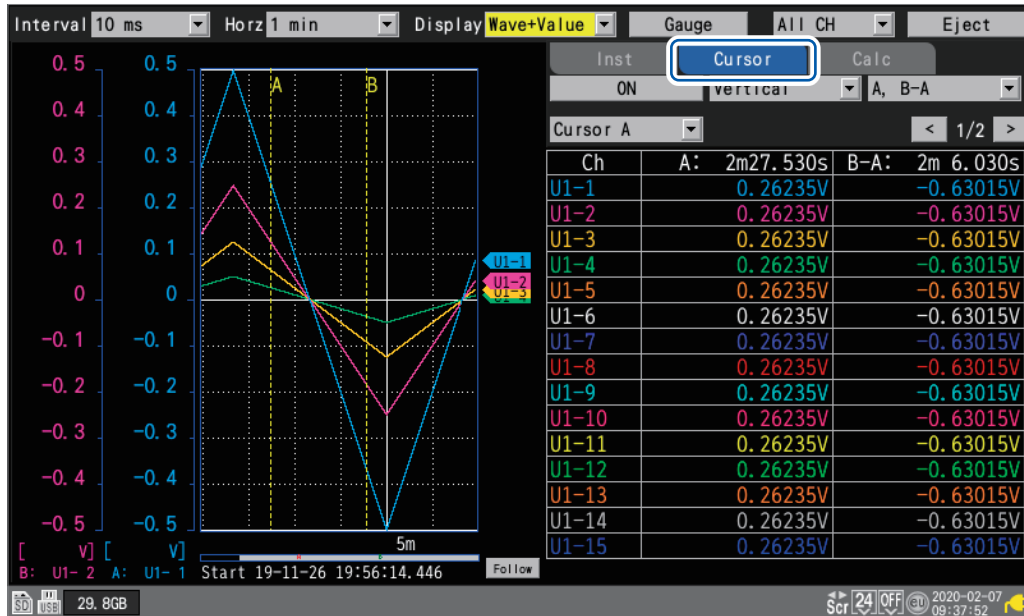

(3) Numerical calculation: Numerical calculation results

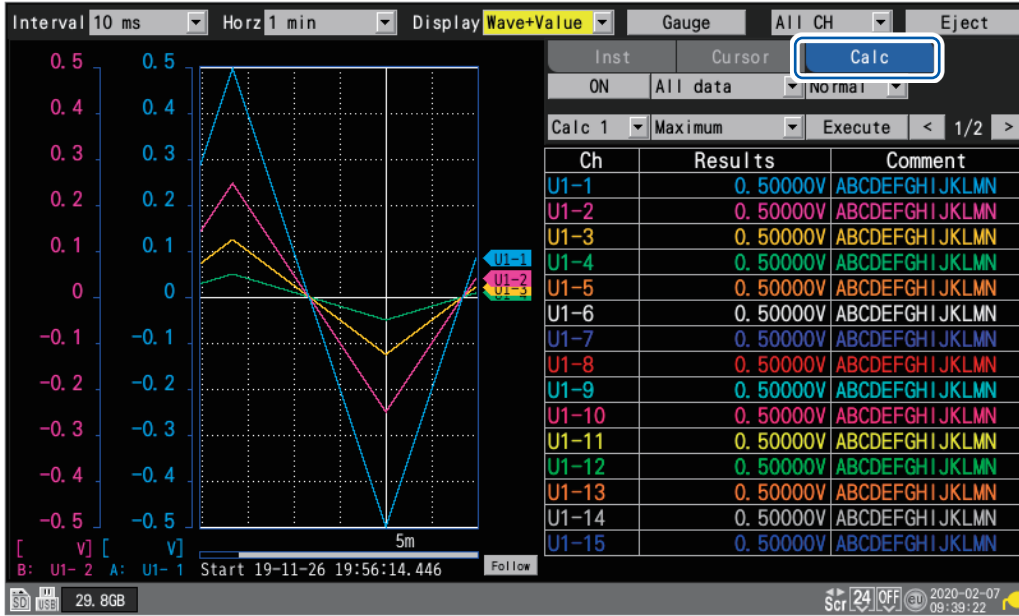

Moving waveforms (scrolling)

This section describes how to move (scroll) the measured waveform horizontally (along the time axis). Since waveforms can also be moved while measurement is in progress, you can check past waveforms during measurement.

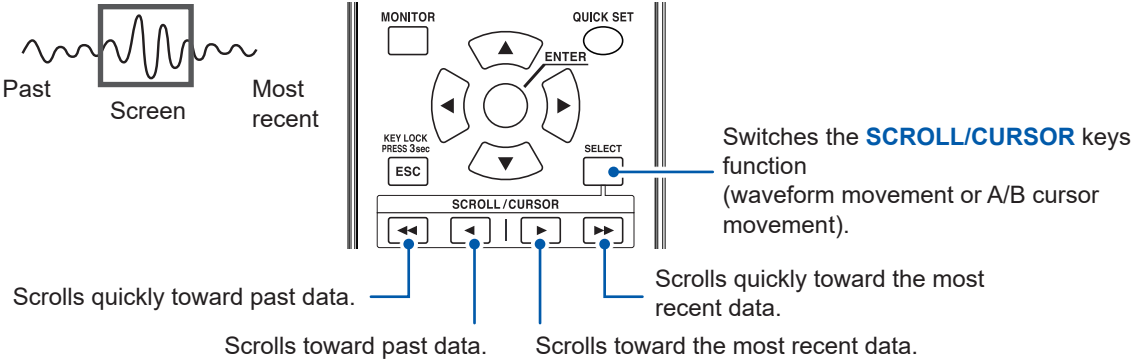

If you wish to move to the most recent waveform

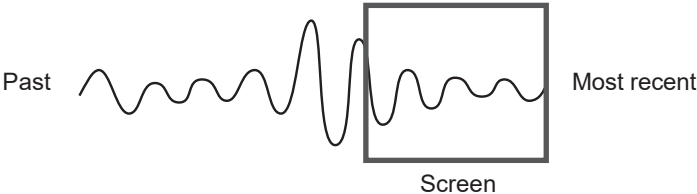

During measurement, press the **ENTER** key while **[Follow]** (on the bottom right of the screen) is selected or use the jump function to move to the end of the waveform. See "Jump function (changing the display position)" (p. 74).

If you wish to move to the beginning of the waveform

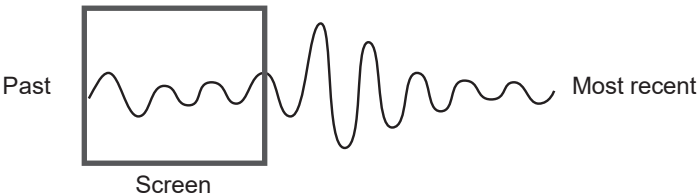

Use the jump function to move to the beginning of the waveform. See "Jump function (changing the display position)" (p. 74).

WAVE

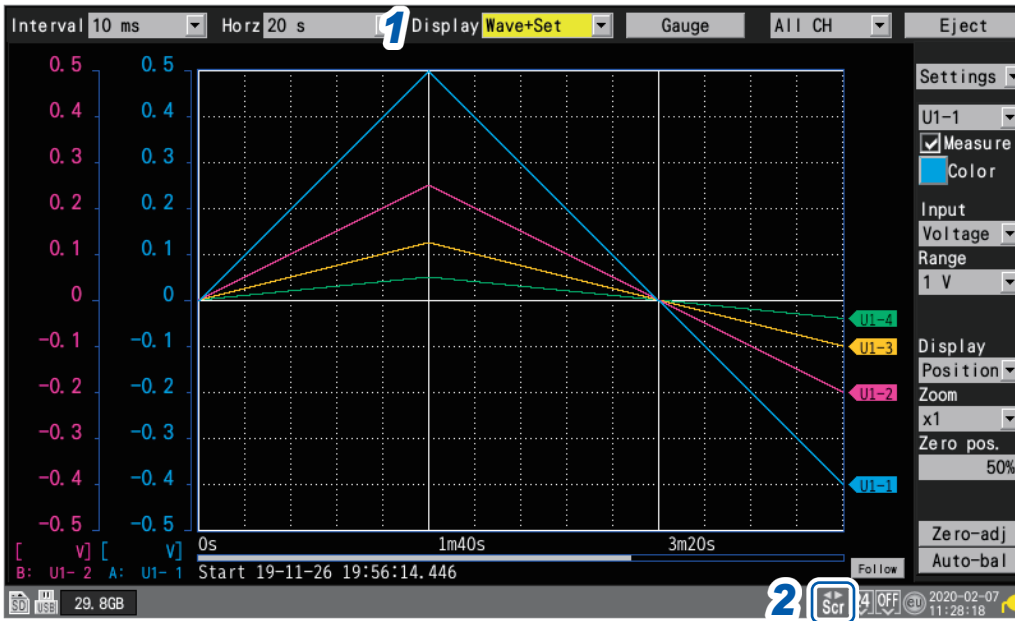

1 Under **[Display]**, set the display to **[Wave+Set]**, **[Wave+Set]**, or **[Wave+Value]**.

2 Press the **SELECT** key to display the **Scroll** icon.

Each time you press the **SELECT** key, the display will switch between the **Cursor** icon (A/B cursor movement) and the **Scroll** icon (waveform movement).

For more information about the **Scroll** icon, see “1.11 Observing Waveforms” (p.60).

3 Press the **SCROLL/CURSOR** keys to move the waveform.

Key operation

	Moves the waveform left a large amount (10 divisions at a time).
	Moves the waveform right a large amount (10 divisions at a time).
	Moves the waveform left a small amount (1 division at a time).
	Moves the waveform right a small amount (1 division at a time).

If the waveform is less than one screen long, you will not be able to move it.

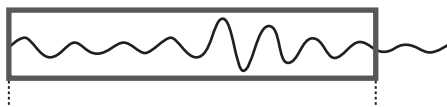

Internal buffer memory (maximum recording time): Displayable range on screen

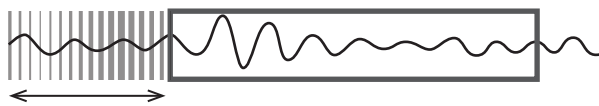

Data deletion

Scroll bar (waveform display position)

A scroll bar is displayed on the bottom of the screen. You can use the scroll bar to check which part of the entire waveform is being displayed. The width shown on the scroll bar varies with the recording time and horizontal axis display settings.

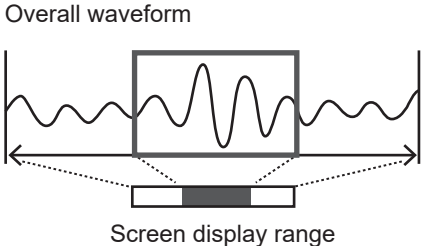

Enlarging and shrinking the waveform horizontally

You can enlarge and shrink the waveform using the horizontal axis display settings. See "Other display settings" (p.40).

When you enlarge the waveform, you can observe detailed variations. When you shrink the waveform, you can quickly ascertain overall variations.

Waveform search

This section describes how to search a measured waveform for a specific point of interest. This function cannot be used while measurement is in progress.

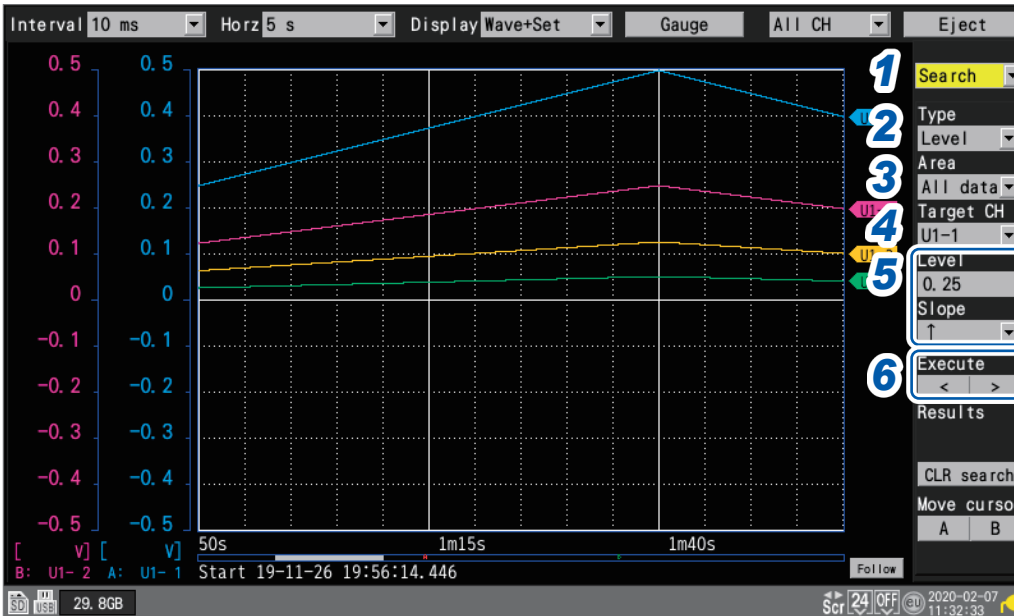

- 1** Under **[Settings]**, select **[Search]**.
A number of search-related settings will be displayed.
- 2** Under **[Type]**, select the search method.

Level	Searches for points that cross the specified level.
Window	Searches for points that lie inside or outside the window defined by the specified upper and lower limit values.
Maximum	Searches for the point at which the maximum value occurs.
Minimum	Searches for the point at which the minimum value occurs.
Maximal	Searches for points at which local maximums occur.
Minimal	Searches for points at which local minimums occur.

- 3** Under **[Area]**, select the search range.

All data	Searches all measured waveforms.
A-B	Searches the range specified with the A/B cursors.

- 4** Under **[Target CH]**, select the channel to search.

- 5** (When **[Type]** is set to **[Level]**)

Under **[Level]**, specify the level to search for.

Under **[Slope]**, select the slope (direction in which the waveform crosses the specified level) to search for.

(When **[Type]** is set to **[Window]**)

Under **[Upr/Lwr]**, specify the upper and lower limit values.

Under **[IN/OUT]**, select the direction in which to search (whether the waveform enters **[IN]** or exits **[OUT]** the area defined by the upper and lower limit values).

6 (When [Type] is set to [Level], [Window], [Maximal], or [Minimal])

Press the **ENTER** key while either [**<**] or [**>**] under [**Execute**] is selected.

The search will be performed. If the search returns multiple points, you can move to the next point with [**>**] or to the previous point with [**<**].

(When [Type] is set to [Maximum] or [Minimum])

Press the **ENTER** key while [**Search**] is selected.

The search will be performed.

An “S” mark will appear at points returned by the search.

You can delete the search results by pressing the **ENTER** key while [**CLR search**] is selected.

You can move the A cursor or B cursor position to an “S” mark position by pressing the **ENTER** key while [**A**] or [**B**] under [**Move cursor**] is selected. The screen will switch to the cursor display on the [**Wave+Value**] screen.

See “(2) Cursor: A/B cursor values” (p.67).



You can search logic waveforms according to the [**Level**] setting.

- With [**Slope**] set to [**↑**], searches for points that rise from the Low level to the High level.
- With [**Slope**] set to [**↓**], searches for points that fall from the High level to the Low level.

Jump function (changing the display position)

This section describes how to use the scroll bar to change the waveform's display position (jump function).

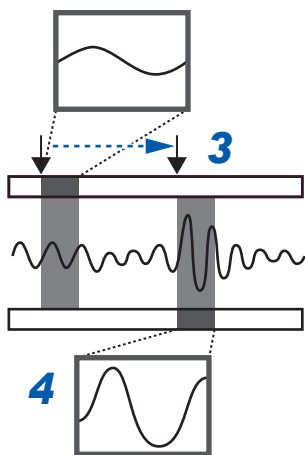
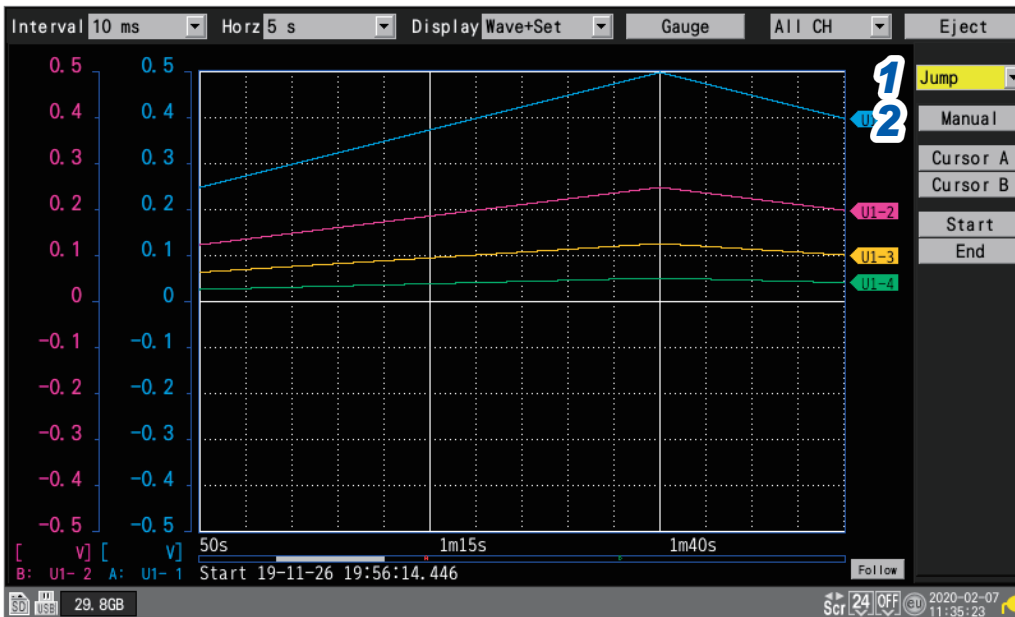

- 1** Under **[Settings]**, select **[Jump]**.
The jump-related settings will be displayed.
- 2** Press the **ENTER** key while **[Manual]** is selected.
An arrow (↓) will indicate the current display position on the scroll bar.
- 3** Move the arrow to the position you wish to display using the **Left Arrow** and **Right Arrow** keys.
- 4** Press the **ENTER** key.
The display will move to the specified location.

You can also change the display position directly without selecting **[Manual]**.

Cursor A	Moves the display to the position of cursor A.
Cursor B	Moves the display to the position of cursor B.
Start	Moves the display to the beginning of the waveform (the measurement start point or the start of data in the internal buffer memory).
End	Moves the display to the end of the waveform (the measurement stop point).

1.12 Using the A/B Cursors

This section describes how to read values from the measured waveform using the A/B cursors. You can also use the cursors to specify a range for saving data or performing numerical calculations.

Reading values from the waveforms

This section describes how to read measured values, times, and time differences between cursors using the A/B cursors.

When using the scaling function, post-scaling values are displayed.

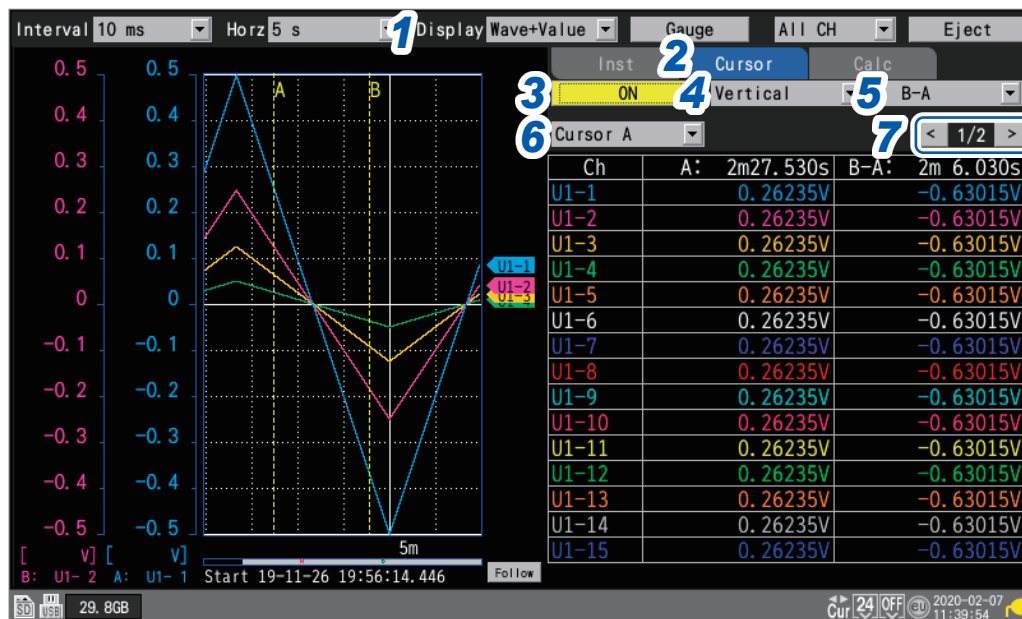

1 Under **[Display]**, set the display to **[Wave+Value]**.

2 Set the display to **[Cursor]**.

3 Select **[ON]** under the A/B cursor settings.

The A/B cursors will be displayed on the screen.

When the Cursor icon is displayed, pressing the any one of the **SCROLL/CURSOR** keys will automatically change the setting to **[ON]** even with the A/B cursors set to **[OFF]**.

4 Select the A/B cursor type.

Vertical	Vertical axis cursors <ul style="list-style-type: none"> • Time values at the A/B cursor positions* • Measured values at the intersections of the A/B cursors and the waveform • Difference in time values at the B and A cursors (B-A)* • Difference in measured values at the B and A cursors (B-A) 	
Horizontal	Horizontal axis cursors <ul style="list-style-type: none"> • Measured values at the A/B cursor positions • Difference in measured values at the B and A cursors (B-A) 	

*: The instrument expresses minute, a unit of time, included in cursor reading values in terms of the letter *m* instead of *min*.

5 Select the information to display.

A, B	A cursor measured value, B cursor measured value
A, B-A	A cursor measured value, difference in measured values at the B and A cursors (B-A)
B, B-A	B cursor measured value, difference in measured values at the B and A cursors (B-A)
A, Comment	A cursor measured value, channel comments
B, Comment	B cursor measured value, channel comments
B-A, Comment	Difference in measured values at the B and A cursors (B-A), channel comments

6 Select the A/B cursor to move.

Cursor A <input type="checkbox"/>	Moves only the A cursor.
Cursor B	Moves only the B cursor.
Sync	Moves the A and B cursors at the same time.

7 Select the channel to display.

You can change the displayed channel by pressing the **ENTER** key while [**<**] or [**>**] is selected.





8 Press the **SELECT** key to display the Cursor icon.

Each time you press the **SELECT** key, the display will switch between the Cursor icon (A/B cursor movement) and the Scroll icon (waveform movement).

For more information about the Cursor icon, see “1.11 Observing Waveforms” (p.60).

9 Press the **SCROLL/CURSOR** keys to move the A/B cursors.

Key operation

	Moves the cursor left a large amount (10 data points at a time).
	Moves the cursor right a large amount (10 data points at a time).
	Moves the cursor left a small amount (1 data point at a time).
	Moves the cursor right a small amount (1 data point at a time).



You can use numerical calculations to calculate values such as the maximum value, minimum value, and average value for measured waveforms. See “6.1 Performing Numerical Calculations” (p. 146).

Specifying a waveform range

This section describes how to specify a waveform range using the A/B cursors. When saving waveform data, you can save only the data in the specified range. You can also specify the range over which to perform numerical calculations. Range specification is performed using the vertical axis cursors.

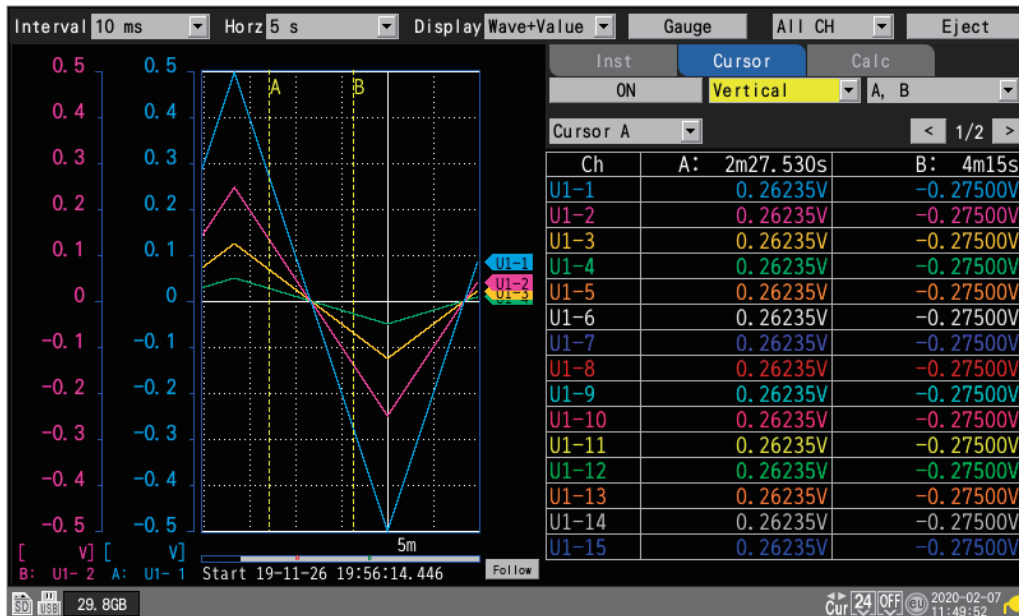

Ranges that can be specified using the A/B cursors

The following settings allow you to specify the range:

- Manual saving: “Under **[Range]**, select the range of data to save.” (p. 113)
- Selective save operation: “Under **[Range]**, select the range of data to save.” (p. 115)
- Numerical calculation: “Specify the range with the A/B cursors.” (p. 152)

All <input checked="" type="checkbox"/>	Selects the waveforms for the entire recorded length, without regard to the A/B cursors.
A-B	Selects the waveforms between the A and B cursors.
Start-A	Selects the waveforms from the beginning to the A cursor.
Start-B	Selects the waveforms from the beginning to the B cursor.
A-End	Selects the waveforms from the A cursor to the end.
B-End	Selects the waveforms from the B cursor to the end.

1.13 Configuration Navigator (Quick Set)



Press the **QUICK SET** key to display the following guides.

- Strain gage connection guide
- External control terminal connection guide

Strain gage connection diagram

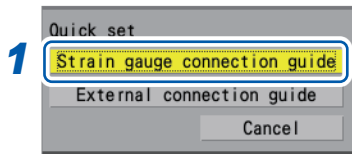

- 1 Select [Strain gauge connection guide].
- 2 Press the **ENTER** key.
A strain gage connection guide will be displayed.



- 3 Select the connection method with the **Right Arrow** and **Left Arrow** keys.
An explanation for the selected connection method will be displayed.
- 4 Press the **ENTER** key while [Quit] is selected.
The guide screen will close.



External control terminal pin names

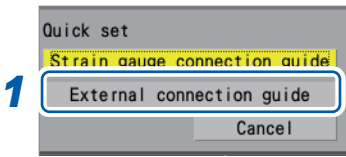

1 Select [External connection guide].

2 Press the ENTER key.

A list of external control terminal pin names will be displayed.

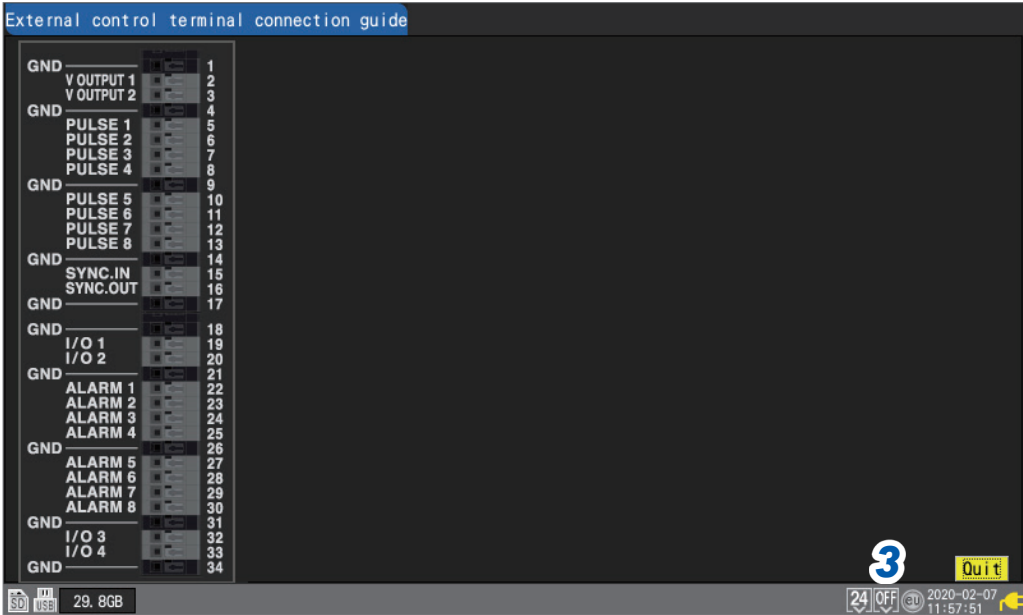

3 Press the ENTER key while [Quit] is selected.

The guide screen will close.

1

Settings and Operation

2 Trigger Function



Triggers provide functionality for starting and stopping measurement based on specific conditions and signals. When a specific condition (a trigger condition) occurs, the trigger is said to activate.

The points at which triggers activate (i.e., the points in time at which trigger conditions are satisfied) are known as trigger points, which are identified by the **T** mark.

When a trigger activates, you can start or stop recording.

Trigger sources can be selected from among the following:

- Analog triggers (level, window)
- Pulse (level, window)
- Logic triggers (condition, pattern)
- Waveform calculation (level, window)
- Interval triggers
- External triggers

2.1 Trigger Meanings.....	p. 83
2.2 Enabling the Trigger Function.....	p. 84
2.3 Analog Triggers, Pulse Triggers, Waveform Calculation Triggers (Level, Window).....	p. 87
2.4 Logic Triggers (Patterns).....	p. 92
2.5 Applying Triggers Based on External Sources	p. 94
2.6 Activating a Trigger at a Set Interval	p. 95
2.7 Example Trigger Settings	p. 97

The instrument allows the following specific conditions to be set:

Specific condition	Description	Reference page
Start trigger	Starts recording when the trigger condition is satisfied. Example: Start recording when the temperature reaches or exceeds 50°C.	p.84
Stop trigger	Stops recording when the trigger condition is satisfied. Example: Stop recording if a signal falls below 1 V.	p.84
External trigger	Allows you to activate a trigger using an external signal. (I/O 3) Example: Control recording based on the operation of other devices.	p.94
Pre-trigger	Records data before the trigger point. Example: Record a phenomenon that precedes an anomaly.	p.84
Interval trigger	Applies the trigger at a set interval. Example: Record data at one-hour intervals.	p.95
Trigger activation conditions	You can set the conditions under which the trigger will activate. Select AND/OR operation between triggers.	p.85

IMPORTANT

- If the trigger function is **[OFF]**, you can start recording by pressing the **START** key. (Free-run)
- If the trigger function is **[ON]**, the instrument will remain in the “trigger standby” state until the trigger condition is satisfied. Recording will start when the trigger condition is satisfied.
- The “trigger standby” interval will be shown on the monitor screen.
See “1.9 Checking Input Signals (Monitor Function)” (p.58).
- The next trigger will not be accepted while trigger processing remains in progress. Trigger output will be active while trigger processing is in progress. For more information about trigger output, see “Trigger output” (p.180).

2.1 Trigger Meanings

This section describes how to set start or stop conditions for measurement. You do so by setting the type of trigger (level, window, or pattern) and the slope (signal rising or falling).

Trigger types

The following three types of triggers are provided:

Type	Operation	Description
Level trigger	↑	Activates when the waveform equals or exceeds the set level while rising.
	↓	Activates when the waveform falls below the set level value. However, the trigger cannot activate when the waveform equals the value while falling.* ¹
Window trigger	IN	Activates when the waveform enters the range defined by a pair of upper and lower limit values. As well, the trigger activates when the waveform equals the upper limit value while falling and the lower limit value while rising.
	OUT	Activates when the waveform exits the range defined by a pair of upper and lower limit values. However, the trigger cannot activate when the waveform equals the upper limit value while rising or the lower limit value while falling.* ²
Pattern trigger	1	Activates when a logic signal changes to 1.
	0	Activates when a logic signal changes to 0.
	X	Ignores the signal. No trigger will activate.

*¹: For pulse channels, only if the level value is set at zero, the trigger can also activate when the pulse equals zero while falling.

*²: For pulse channels, only if the lower limit value is set at zero, the trigger can also activate when the pulse equals zero while falling. As well, only if the upper limit value is set at zero, the trigger can also activate when the pulse equals zero while rising.

2.2 Enabling the Trigger Function

This section introduces how to start and stop recording using the trigger function.

Shared settings

SET > Trigger > Common

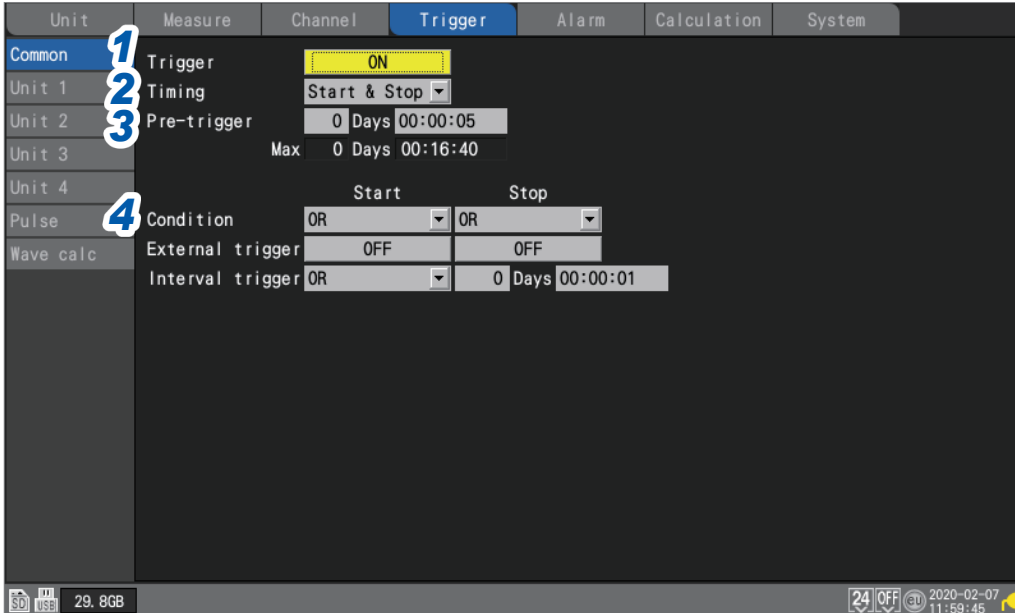

1 Under **[Trigger]**, set the trigger function to **[ON]**.

OFF , ON

The trigger function will be set to **[ON]**, and trigger settings will be enabled.

2 Under **[Timing]**, select the operation to perform when the trigger activates.

Start <input checked="" type="checkbox"/>	Starts recording when the trigger condition is satisfied (start trigger). Example: Starts recording when the temperature reaches or exceeds 50°C.
Stop	Stops recording when the trigger condition is satisfied (stop trigger). Example: Stops recording if a signal falls below 1 V.
Start & Stop	Starts recording when the start trigger condition is satisfied, and stops recording when the stop trigger condition is satisfied during recording. Example: Starts recording when the temperature reaches or exceeds 50°C and stops recording when the temperature reaches or exceeds 100°C.

3 Under **[Pre-trigger]**, set the time or number of days you wish to record before the trigger.

You can record data before the trigger point (the point in time at which the trigger activates). The ability to record data preceding an anomaly is useful when you need to analyze the cause of an issue.

The pre-trigger will be disabled if the operation to perform when the trigger activates has been set to **[Stop]** under **[Timing]**.

DD, HH:MM:SS

The maximum setting available for the instrument is 99 days.

Tips To continue recording the waveform after the trigger, make the recording time longer than the pre-trigger.

4 Under [Condition], select the condition for activating the trigger.

Set the activation condition between triggers (analog, pulse, logic, waveform calculation, external, and interval) as a logical AND or logical OR operation.

Recording will start immediately (free-run) if all trigger sources are OFF (if no trigger setting has been made).

OR <input checked="" type="checkbox"/>	The trigger will activate when even one of the trigger conditions is satisfied (edge-sensitive).
AND	The trigger will activate when all of the trigger conditions are satisfied (level-sensitive).

No trigger can activate when the trigger conditions have already been satisfied at the start of measurement. The trigger will become able to activate when input signals that did not satisfy the trigger conditions have just satisfied.

Example: To apply the trigger when the waveform crosses 0 V from below to above

Trigger: Level trigger

Level: 0 V

Slope: ↑

[OR]

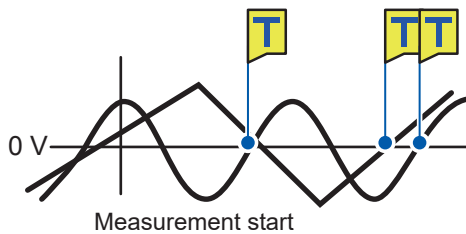

Activates the trigger when either one crosses 0 V from below to above.

[AND]

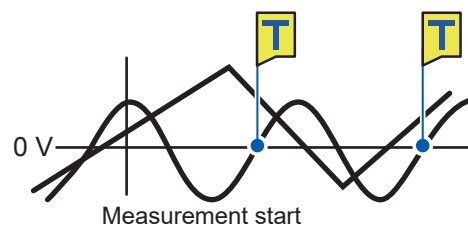

Activates the trigger when either one crosses 0 V from below to above while the other is exceeding 0 V.

Difference between pre-trigger standby and trigger standby

When measurement starts, the instrument does not honor any triggers before the amount of time set for the pre-trigger has not elapsed. During this period, the screen will display **[Waiting for pre-trigger...]**. After the amount of time set for the pre-trigger has elapsed, the instrument will start waiting for the trigger to be satisfied. During this period, the screen will display **[Waiting for trigger...]**.

During pre-trigger standby, the trigger will not activate, even if the trigger conditions are satisfied.

Relationship between pre-triggers and recording time

If the recording time is shorter than the pre-trigger

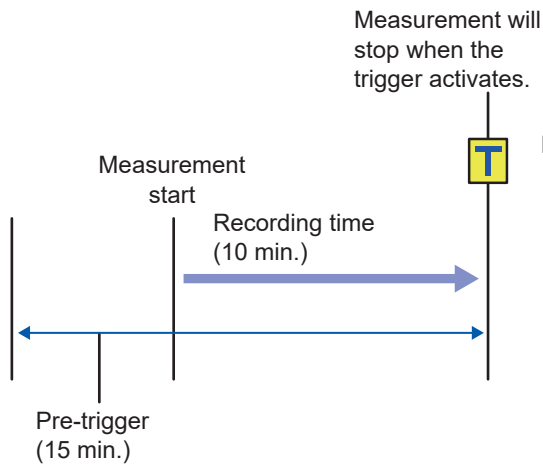

If the recording time is longer than the pre-trigger

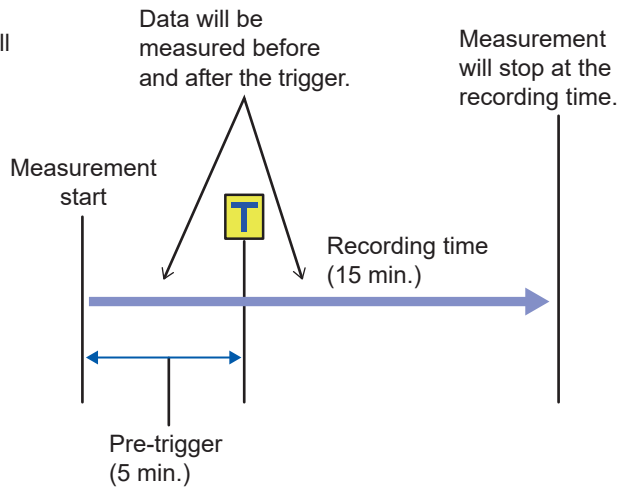

2.3 Analog Triggers, Pulse Triggers, Waveform Calculation Triggers (Level, Window)

This section describes how to set triggers for individual analog channels, pulse channels, or waveform calculation channels.

The following triggers are available:

- Level triggers
- Window triggers

SET > **Trigger** > **[Unit n]** (n = 1, 2, . . .), **[Pulse]**, or **[Waveform calculation]**



- 1 On the sub tab **[Unit n]**, **[Pulse]**, or **[Wave calc]**, select a module.
Unconnected modules will not be displayed.
- 2 Press the **ENTER** key while **[Un-m]** (analog triggers), **[Pm]** (pulse triggers), or **[Wm]** (waveform calculation triggers) for the channel you wish to set is selected (m = 1, 2, . . .).
The channel trigger settings window will open.

Analog triggers

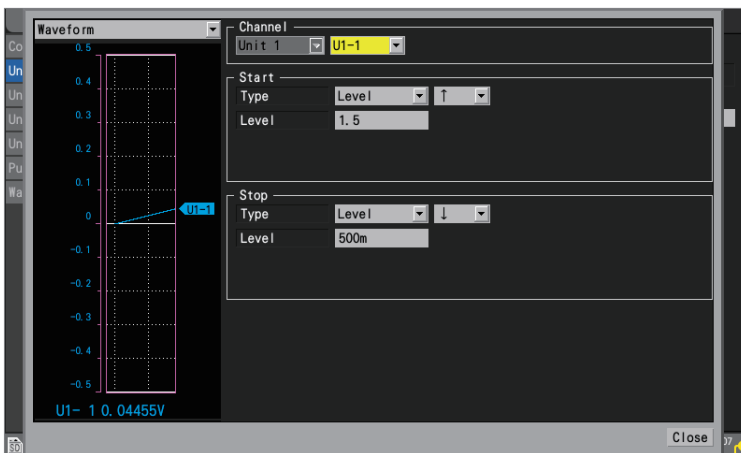

Pulse triggers

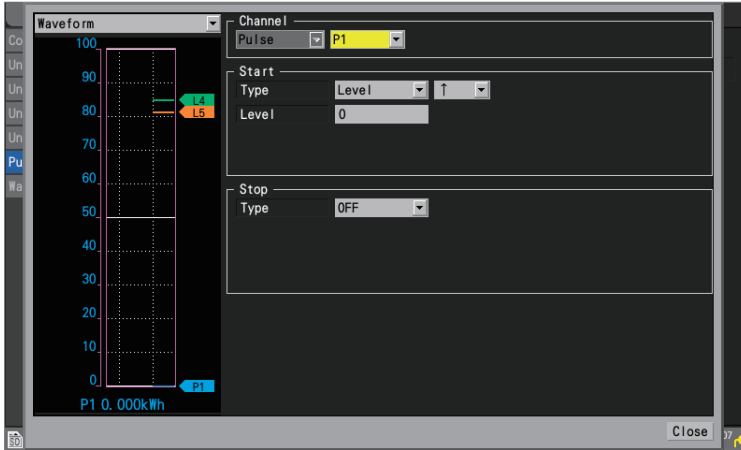

Waveform calculation triggers

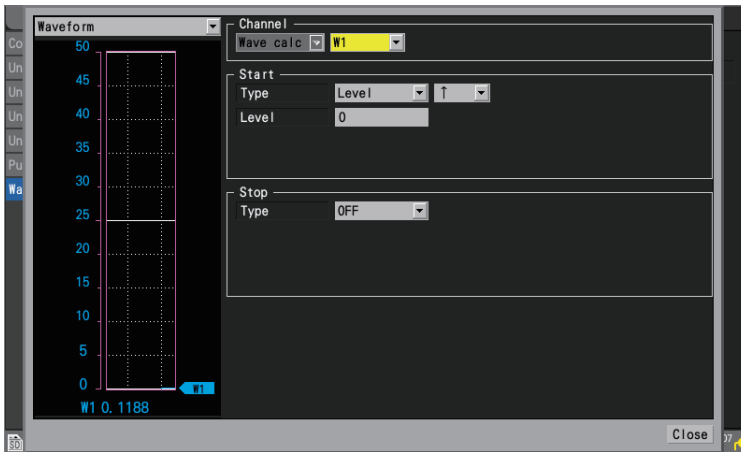

See “Level triggers” (p.89) and “Window triggers” (p.91).

3 Configure the trigger function settings.

You can also configure settings on the list screen without opening the settings window.

When **[Timing]** is set to **[Start]**, a **[Start]** trigger will be set.

When **[Timing]** is set to **[Stop]**, a **[Stop]** trigger will be set.

When **[Timing]** is set to **[Start & Stop]**, two triggers will be set (one **[Start]** trigger and one **[Stop]** trigger).

For more information about trigger timing, see “Shared settings” (p.84).

Level triggers

Level triggers activate when the waveform crosses the specified level (the trigger level). You can set the direction in which the level is crossed (the slope).

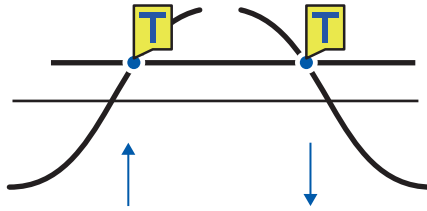

SET > **Trigger** > **[Unit n]** (n = 1, 2, ...)

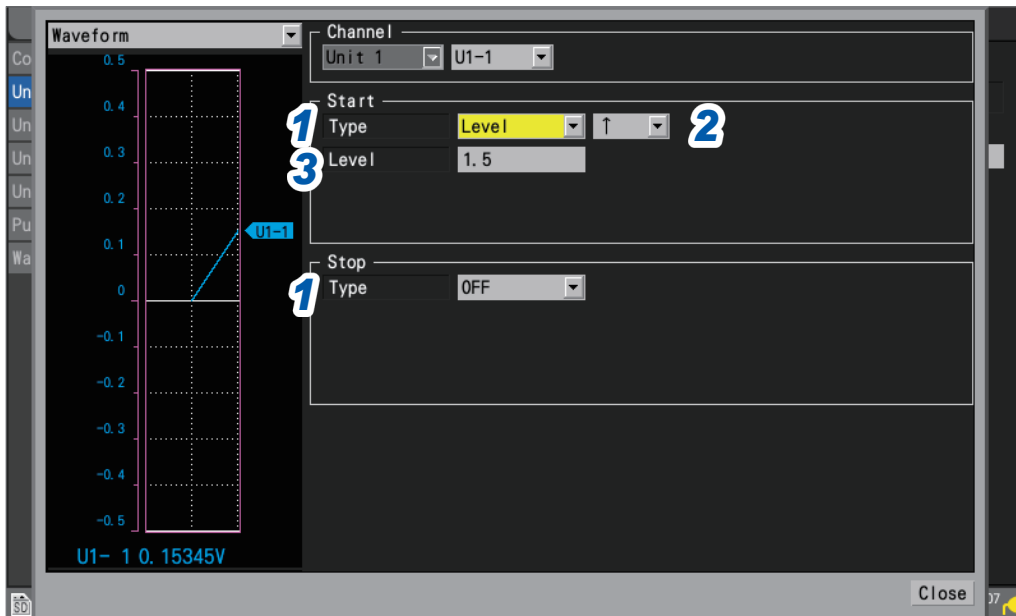

1 Under **[Type]** for **[Start]** or **[Stop]**, set the trigger type to **[Level]**.

A level trigger will be used.

2 Select the slope.

The trigger will activate when the level is crossed in the set direction.

↑ <input checked="" type="checkbox"/>	Activates the trigger when the level is crossed the specified level from below. (Rising)
↓	Activates the trigger will activate when the level is crossed the specified level from above. (Falling)

When **[Condition]** is set to **[AND]**, the system will determine whether the waveform has exceeded the specified level.

3 Under **[Level]**, set the trigger level.

The trigger will activate when the set level (temperature, voltage, etc.) is crossed. When using the scaling function, post-scaling values are displayed.

(When a strain measurement module is used)

The instrument expresses strain in terms of micro epsilon ($\mu\epsilon$). You do not need to enter the SI prefix micro (μ).

Trigger level resolution

The trigger level resolution (minimum setting width) varies with the range.

Input	Range	Resolution
Voltage	1 mV f.s.	0.001 mV
	2 mV f.s.	0.002 mV
	5 mV f.s.	0.005 mV
	10 mV f.s.	0.01 mV
	20 mV f.s.	0.02 mV
	50 mV f.s.	0.05 mV
	100 mV f.s.	0.1 mV
	200 mV f.s.	0.2 mV
	1 V f.s.	0.001 V
	2 V f.s.	0.002 V
	10 V f.s.	0.01 V
	20 V f.s.	0.02 V
	100 V f.s.	0.1 V
	1 to 5 V f.s.	0.01 V
Temperature (for both thermocouples and resistance temperature detectors)	100°C f.s.	0.1°C
	500°C f.s.	0.5°C
	1000°C f.s.	1°C
	2000°C f.s.	2°C
Humidity	100% RH f.s.	0.1% RH
Resistance	10 Ω f.s.	0.01 Ω
	20 Ω f.s.	0.02 Ω
	100 Ω f.s.	0.1 Ω
	200 Ω f.s.	0.2 Ω
Integration	–	1 c
Rotational speed	5000 r/s	1 r/s
	300,000 r/min.	1 r/min.
Strain	1000 με f.s.	1 με
	2000 με f.s.	2 με
	5000 με f.s.	5 με
	10000 με f.s.	10 με
	20000 με f.s.	20 με
	50000 με f.s.	50 με
	100000 με f.s.	100 με
	200000 με f.s.	200 με

Window triggers

This section describes how to specify a range (window) using upper and lower limit values and then activate a trigger when the waveform moves into or out of that range. You can activate a trigger either when the waveform enters the range (window IN) or when the waveform exits the range (window OUT).

Window IN

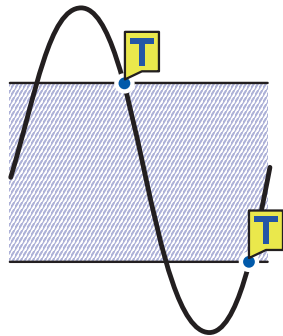

Window OUT

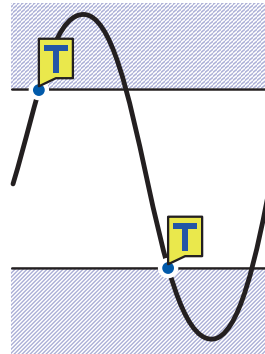

SET > Trigger > [Unit n] (n = 1, 2, ...)

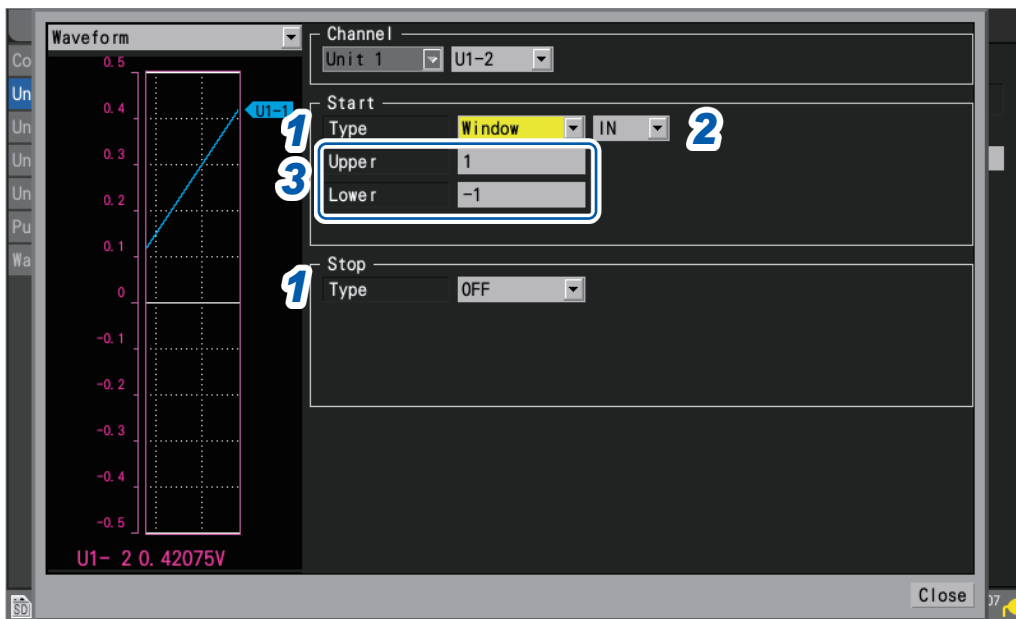

1 Under [Type] for [Start] or [Stop], set the trigger type to [Window].

A window trigger will be used.

2 Choose between [IN] and [OUT] for the waveform.

IN <input checked="" type="checkbox"/>	Activates the trigger when the waveform enters the specified range.
OUT	Activates the trigger when the waveform exits the specified range.

When [Condition] is set to [AND], the system will determine whether the waveform is inside the specified range.

3 Under [Upper] and [Lower], set the upper and lower limit values, respectively.

The range defined by the upper and lower limit values will serve as the window. When using the scaling function, post-scaling values are displayed.

2.4 Logic Triggers (Patterns)

This section describes how to activate triggers with logic triggers. When the logic signal values (1 and 0) match the trigger pattern (1/0/X), the trigger will activate. This type of trigger can be selected when **[Logic]** has been selected for pulse (P1 to P8) input. See “Measuring logic signals” (p.34).

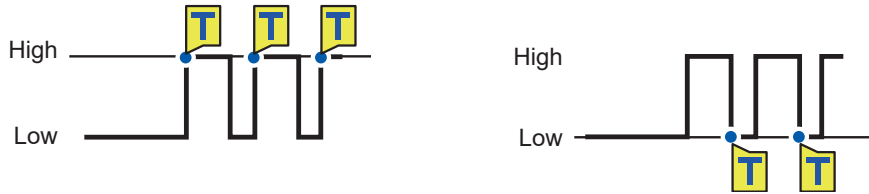

SET > **Trigger** > **Pulse**

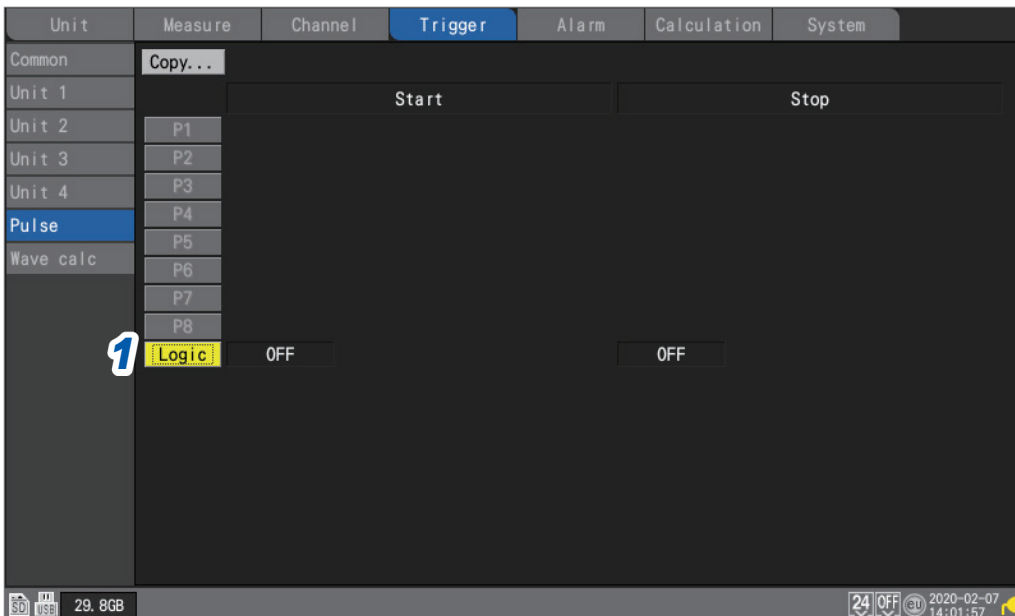

- 1 Press the **ENTER** key while **[Logic]** is selected. The logic trigger settings window will open.

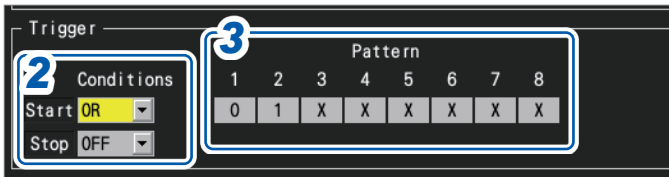

- 2 Under **[Condition]**, select the pattern for activating the trigger.

OFF <input checked="" type="checkbox"/>	Does not use a pattern trigger.
OR	Activates the trigger when even one of the trigger patterns matches (edge-sensitive).
AND	Activates the trigger when all of the trigger patterns match (level-sensitive). No trigger can activate, however, when the logic trigger conditions have already satisfied at the start of measurement. The trigger will become able to activate once the logic trigger conditions have not been satisfied.

3 Select the P1 to P8 trigger pattern.

0	Activates the trigger when the signal is [0] (low).
1	Activates the trigger when the signal is [1] (high).
X	Excludes from the trigger. The signal will be ignored.

2

Trigger Function

2.5 Applying Triggers Based on External Sources

This section describes how to use signals inputted to the terminal **I/O 3** to activate triggers.

SET > **Trigger** > **Common**

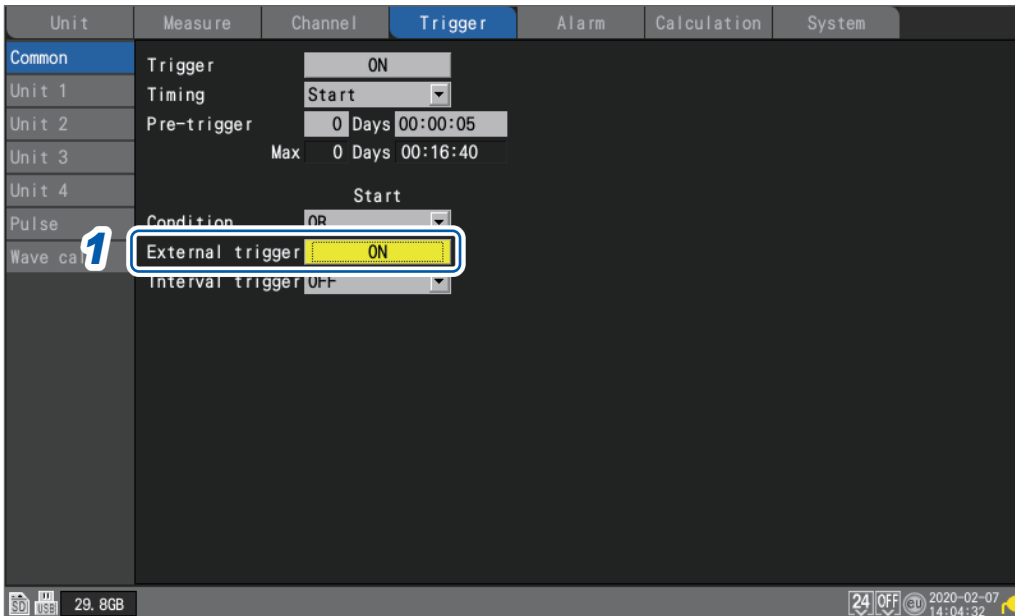

- 1 Under **[External trigger]**, set the external trigger function to **[ON]**.

OFF , **ON**

The external trigger function will be enabled, allowing you to activate triggers based on signals inputted from external sources.

When **[External trigger]** is set to **[ON]**, the external input 3 terminal will be set to **[Trigger input]**. See "External trigger input" (p. 179).

2.6 Activating a Trigger at a Set Interval

Interval triggers

This section describes how to activate a trigger at a set interval.
 You need to set repeat recording set to **[ON]** beforehand.
 See “1.2 Setting Measurement Conditions” (p. 10).

SET > **Trigger** > **Common**

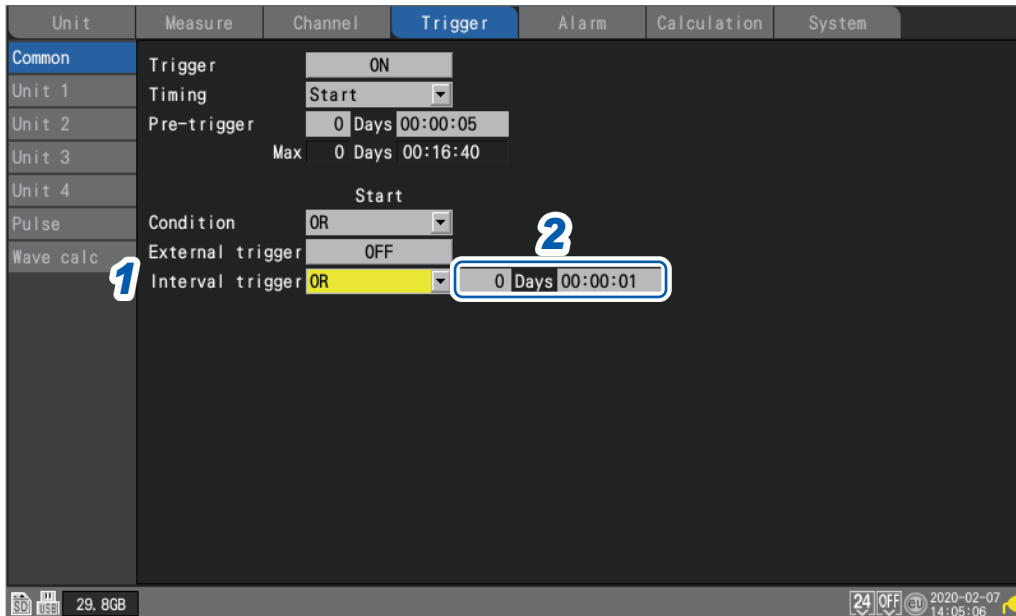

2

Trigger Function

1 Under **[Interval trigger]**, select the interval trigger conditions.

If you wish to give priority to the interval trigger, use the **[OR]** setting. (p. 96)

If you wish to give priority to other triggers, use the **[AND]** setting. (p. 96)

OFF <input checked="" type="checkbox"/>	Does not use the interval trigger.
OR	Uses the interval trigger based on OR logic.
AND	Uses the interval trigger based on AND logic.

2 Set the interval for the interval trigger.

DD, HH:MM:SS

The trigger will simultaneously activate when measurement starts. Subsequently, the trigger will activate at every interval trigger interval.

OR and AND conditions

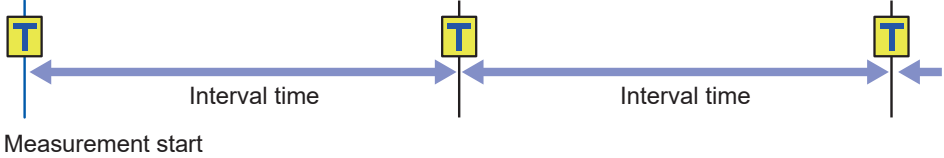
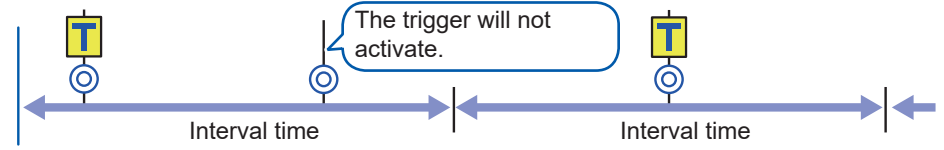
Trigger conditions	
<p>OR</p>	 <p>Measurement start</p>
<p>AND</p>	<p>There is one enabled trigger during the interval.</p>  <p>Measurement start</p> <p>The trigger will not activate if it does not match other trigger conditions. (If no other trigger conditions have been set, this setting will result in the same operation as OR logic.)</p>

2.7 Example Trigger Settings

This section introduces some example trigger settings.

What you want to do	See (in table below)
Capture data from the time the START key is pressed until the time the STOP key is pressed	No.1
Capture data once for 1 min. starting from when the START key is pressed	No.2
Capture data for 1 min. repeatedly starting from when the START key is pressed until 60 min. elapses.	No.3
Once the CH1 measured temperature reaches or exceeds 500°C, capture data until the STOP key is pressed	No.4
Capture data starting when the START key is pressed until the CH1 measured temperature reaches or exceeds 500°C	No.5
Once the CH1 measured temperature reaches or exceeds 500°C, capture data until the temperature falls below 300°C	No.6
Once the CH1 measured temperature reaches or exceeds 500°C, capture data repeatedly until the temperature falls below 300°C	No.7
Once the CH1 measured temperature reaches or exceeds 500°C, capture data for the next 1 min.	No.8
Capture data for 1 min. before and after the CH1 measured temperature reaches or exceeds 500°C	No.9

No.	Measurement screen			Trigger screen					
	Repeat recording	Recording time	File splitting	Trigger function	Timing	Trigger conditions	Pre-trigger	Start trigger	Stop trigger
1	OFF	Continuous recording	OFF	OFF	–	–	–	–	–
2	OFF	Specified time 0 hr. 1 min. 0 s	OFF	OFF	–	–	–	–	–
3	OFF	Specified time 1 hr. 0 min. 0 s	ON Segment time: 1 min.	OFF	–	–	–	–	–
4	OFF	Continuous recording	OFF	ON	Start	Start OR	–	Condition level: ↑ Level: 500°C	–
5	OFF	Continuous recording	OFF	ON	Stop	Stop OR	–	–	Condition level: ↑ Level: 500°C
6	OFF	Continuous recording	OFF	ON	Start & stop	Start OR Stop OR	–	Condition level: ↑ Level: 500°C	Condition level: ↓ Level: 300°C
7	ON	Continuous recording	OFF	ON	Start & stop	Start OR Stop OR	–	Condition level: ↑ Level: 500°C	Condition level: ↓ Level: 300°C

Example Trigger Settings

No.	Measurement screen			Trigger screen					
	Repeat recording	Recording time	File splitting	Trigger function	Timing	Trigger conditions	Pre-trigger	Start trigger	Stop trigger
8	OFF	Specified time 0 hr. 1 min. 0 s	OFF	ON	Start	Start OR	–	Condition level: ↑ Level: 500°C	–
9	OFF	Specified time 0 hr. 2 min. 0 s	OFF	ON	Start	Start OR	1 min.	Condition level: ↑ Level: 500°C	–



This chapter describes how to save settings conditions and waveform data on an SD Memory Card or USB Drive. It also describes how to load previously saved data into the instrument to reproduce it.

3.1 Data That Can Be Saved and Loaded	p. 100
3.2 Formatting Media	p. 103
3.3 Saving Data	p. 105
Auto save (real-time save)	p. 106
Manual saving (selective saving, immediate saving)	p. 112
Selective save operation	p. 114
3.4 Loading Data	p. 117
3.5 Managing Data	p. 119
Switching media (drives)	p. 119
Moving between levels (folders).....	p. 120
Deleting data	p. 121
Renaming files and folders.....	p. 122
Copying data	p. 123
Sorting files.....	p. 124
3.6 Acquiring Data with a Computer (PC)	p. 125
Connecting the USB cable	p. 125
Activating USB drive mode.....	p. 126
Canceling USB drive mode	p. 127

3.1 Data That Can Be Saved and Loaded

When you save data on an SD Memory Card or USB Drive, the **[HIOKI]** folder containing the **[LR8450]** folder.

will be created.

Files are saved in folders as shown in the following diagram:

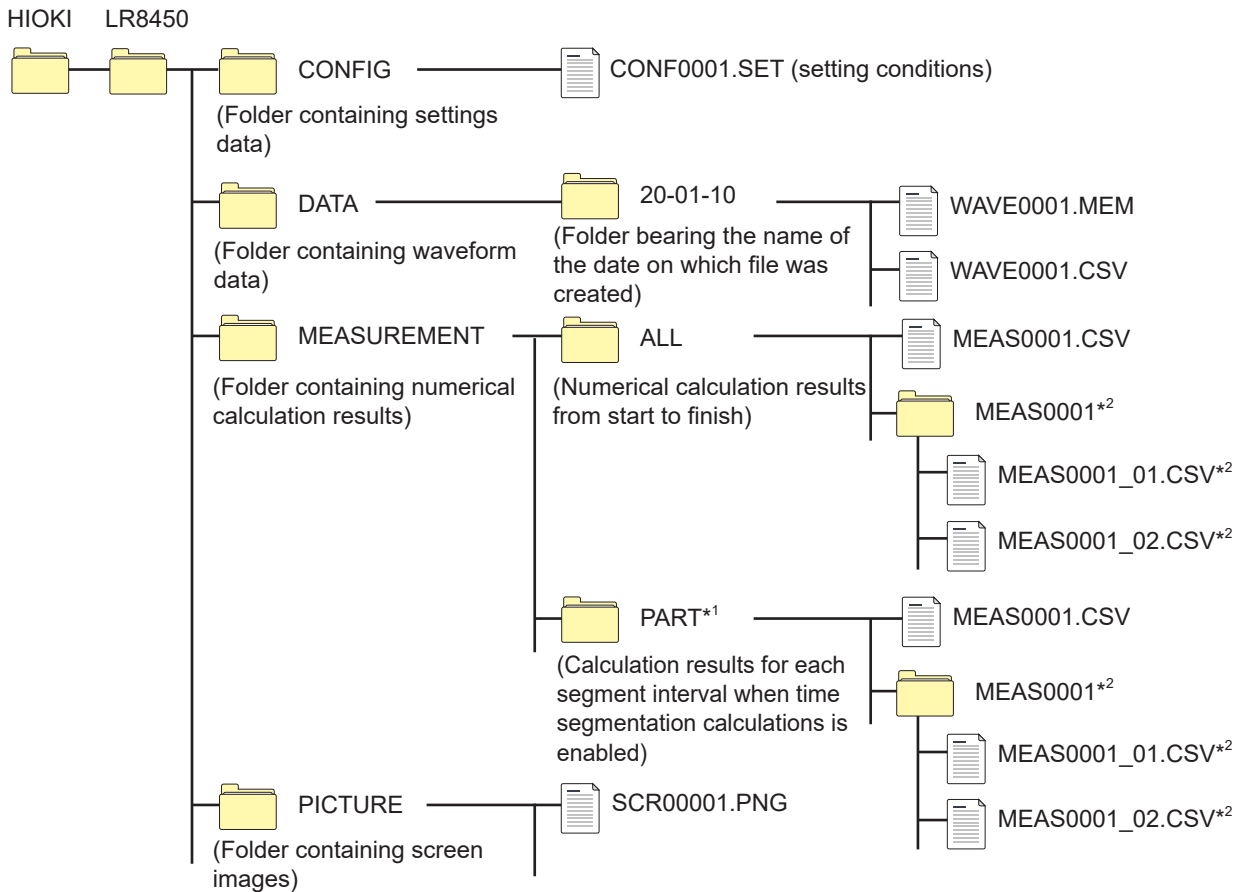

*1: When the calculation range is set to **[Enable]** under **[Time split calculation]**, a folder named **[PART]** will be added. Calculation results from the start point to the stop point will be saved in the **[ALL]** folder, while calculation results for each segment will be saved in the **[PART]** folder.

*2: Created when saving operation is set such that each calculation is saved in its own file.

When saving files without specifying a filename

The following filenames will be used:

- Automatically saved waveform data: AUTO****.xxx
- Automatically saved numerical calculation result: AUTO****.xxx
- Manually saved settings data: CONF****.SET
- Manually saved waveform data: WAVE****.xxx
- Manually saved numerical calculation results: MEAS****.xxx
- Manually saved screen image data: SCR****.PNG

[**]** indicates a number (0001 to 9999).

[.xxx] indicates the file's extension (.MEM, .CSV, .TXT).

✓: Yes; -: No

Data type	Format	Folder name	Filename ⁵ (Automatically numbered from 1)	Saving		Loading	
				Auto.	Manual	On the instrument	On a computer
Setting conditions	Binary	CONFIG	CONF0001.SET	-	✓	✓	-
Waveform data ^{*1}	Binary	DATA\ <date>*⁴ Example: 20-01-10</date>	AUTO0001.MEM WAVE0001.MEM	✓	✓	✓	✓
	Text ^{*2}	DATA\ <date>*⁴ Example: 20-01-10</date>	AUTO0001.CSV WAVE0001.CSV ^{*6}	✓	✓	-	✓
Numerical calculation results	Text ^{*2}	MEASUREMENT	AUTO0001.CSV MEAS0001.CSV ^{*7}	✓	✓	-	✓
Screen image data	PNG ^{*3}	PICTURE	SCR00001.PNG ^{*3}	-	✓	-	✓

- *1: Save data in the binary format if you plan to load it with the instrument or the Logger Utility. Some measurement setting conditions will be saved along with the waveform data. You can also specify a range of data using the A/B cursors (partial save).
When you save waveform data after the scaling conversion in the binary format, raw data (data prior to the scaling conversion) and scaling settings are recorded. Loading waveform data allows waveforms after the scaling conversion to be displayed. You can review the pre-conversion waveforms if you turn off the scaling setting.
- *2: There is a limit on the number of rows that can be loaded at once when loading CSV files with spreadsheet software.
- *3: PNG format: An image format defined by the ISO/IEC 15948 international standard.
- *4: Date folders (“year-month-day”) will be automatically generated in the **[DATA]** folder. When the number of files in a folder exceeds 1000, a new folder will be created.
Example: 20-01-10_1000
- *5: For more information about filenames when saving data manually, see “11.6 Filenames” (p.286).
- *6: When a setting other than **[Comma]** is selected under **[Delimiter]**, the extension will be set to **[.TXT]**. (p.109)
- *7: When **[Individual calc]** is selected, the string representing a calculation number will be appended, as in **[MEAS0001_1.CSV]** and **[MEAS0001_2.CSV]**.



It is recommended to store fewer than 1000 files per folder.

You can save more than 1000 files in a single folder, but save times will increase with the file count.

Additionally, the file screen can display a maximum of 1000 files. During automatic saving, a new folder will be created when the number of files in a folder exceeds 1000.

Preparing for power outages and configuring associated settings

NOTICE



■ **Do not use damaged media.**

Doing so could prevent processing to close files from completing in the anticipated amount of time, corrupting files.

Measurement data will be lost if power is interrupted during measurement. It is recommended to make the following preparations and settings when measuring data for an extended period of time.

- Use the Z1007 Battery Pack.
When using the optional Z1007 Battery Pack, the instrument will switch immediately to battery power if power from the AC Adapter is interrupted. In this way, measurement can be continued without losing any data.
If the battery's remaining charge declines, the instrument will not be able to save or load data. See "2.2 Installing a Battery Pack" in the Quick Start Manual.
- Set auto saving to **[Waveform data]**.
Waveform data will be saved to an SD Memory Card or USB Drive while measurement continues. You can continue measurement in the event of a power outage by using the Z1007 Battery Pack. See "3.3 Saving Data" (p. 105).



It is recommended to use the **[Binary]** (MEM) setting for auto saving.
Files saved using the **[Text]** (CSV) setting cannot be loaded by the instrument or the Logger Utility.
Binary data (MEM files) saved using the **[Binary]** setting can be converted to the CSV format using the Logger Utility.

3.2 Formatting Media

Before using an SD Memory Card or USB Drive for the first time, format the media.

1 Press the FILE key.

A screen listing the files on the SD Memory Card or USB Drive will be displayed.

2 Press the FILE key to select the media to be formatted.

Each time you press the FILE key, the display will switch between the SD Memory Card and the USB Drive.

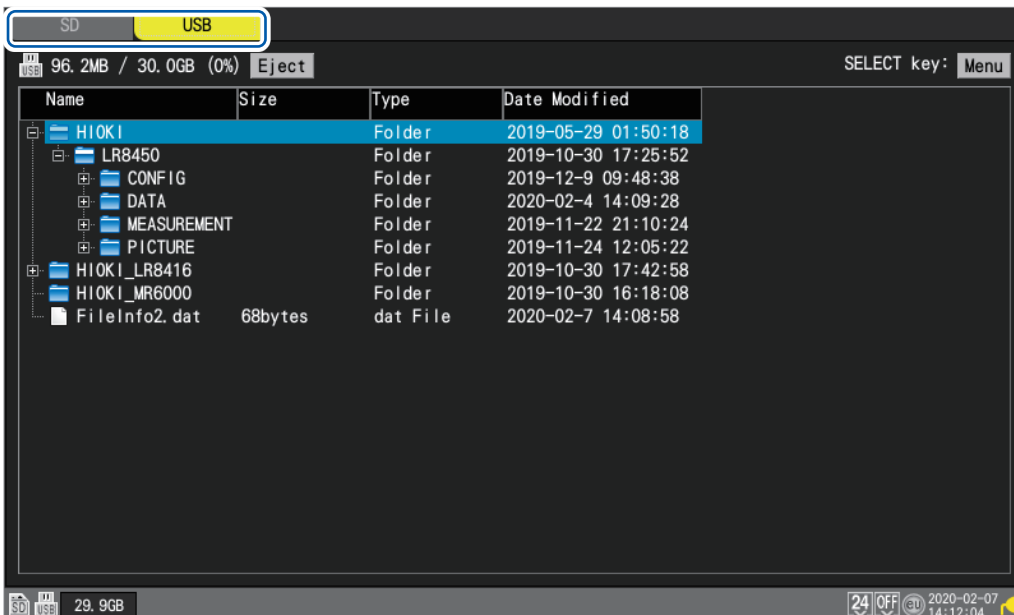
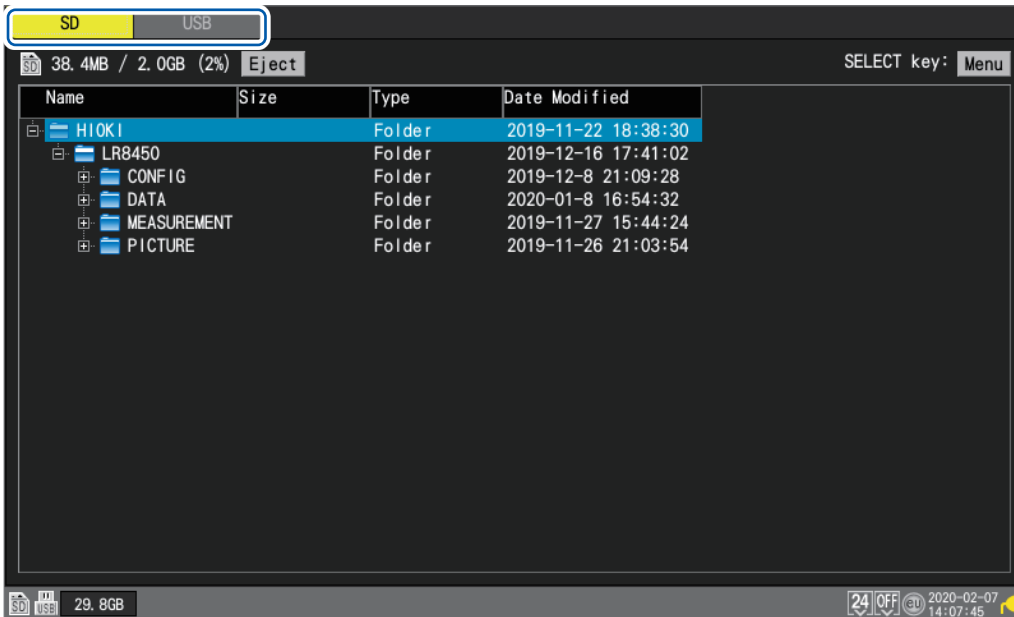

3

Saving and Loading Data

- Press the **Down Arrow** key to move to the media screen, and then press the **SELECT** key. The file operations window will be displayed.

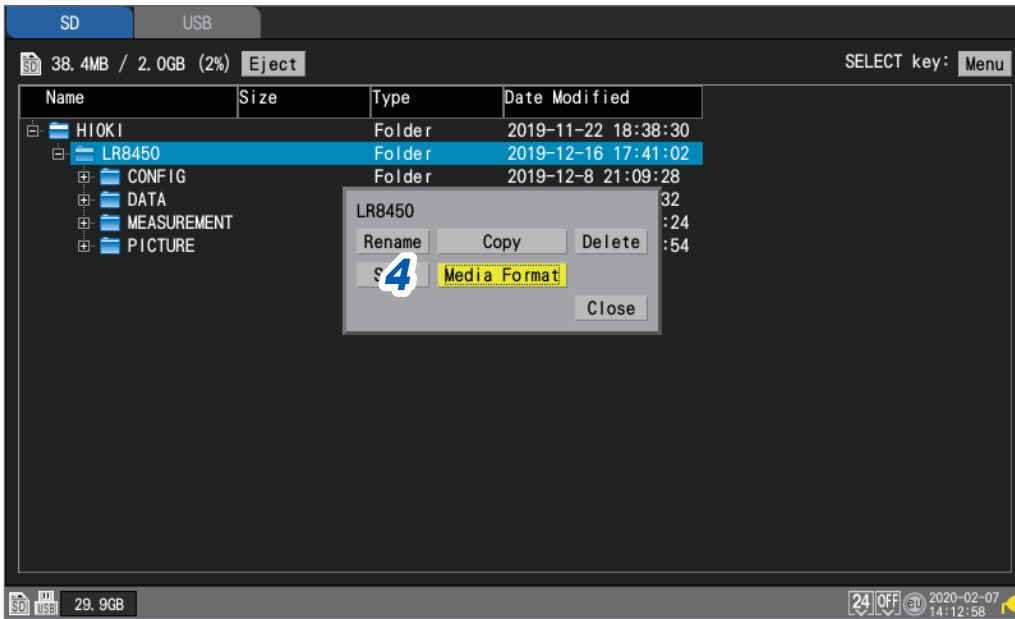

- Pressing the **ENTER** key while [**Media Format**] is selected. The confirmation window will be displayed.
- Press the **ENTER** key. The media will be formatted.

IMPORTANT

- Format a virgin SD Memory Card and USB Drive with the instrument before the first use of them. Using those formatted with a computer could prevent the real-time saving from keeping up with measurement.
- When formatting an SD Memory Card or USB Drive, select the FAT/FAT32 format. If you use another format (NTFS, etc.), the instrument will not recognize the device.
- Be sure to back up any important data on SD Memory Cards and USB Drives. When you format an SD Memory Card or USB Drive, all the saved data will be erased. The formatting operation cannot be undone.



3.3 Saving Data

Data can be saved using the following three methods:

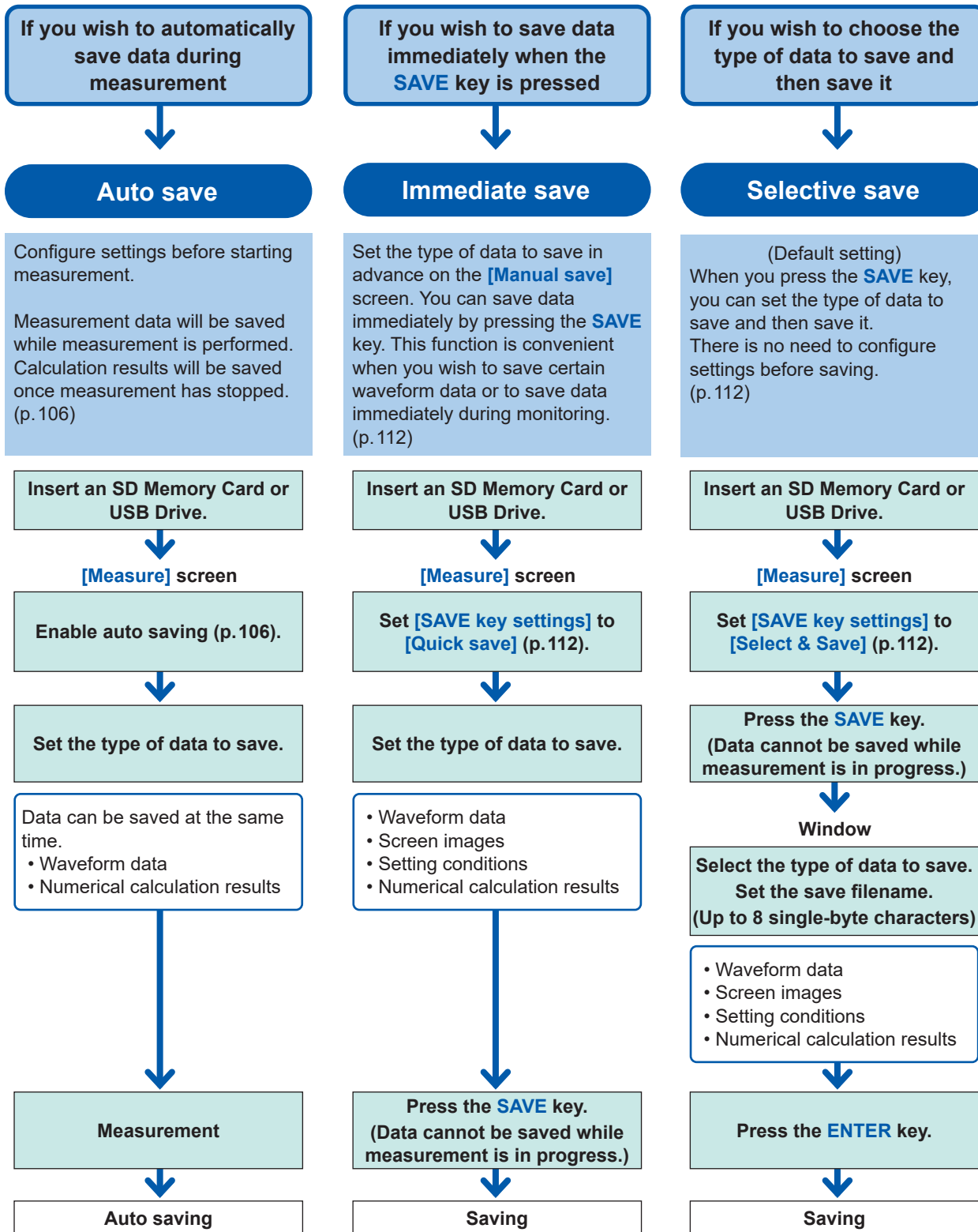

To save part of a waveform, specify a range using the A/B cursors (vertical) before saving the data. (Partial save functionality is not available when using the auto save function.) See “Specifying a waveform range” (p. 77).

Auto save (real-time save)

This section describes how to save waveform data (using the real-time save function) to media (an SD Memory Card or USB Drive) while measurement is in progress. Numerical calculation results can also be saved to media automatically. You can also save both waveform data and numerical calculation results automatically.

The following measurement data can be saved automatically:

Saved data	Setting	File extension	Description
Waveform data	Binary format	.MEM	Waveform data will be saved in the instrument's dedicated format (binary format) while measurement continues. Ordinarily, it is recommended to use the [Binary] setting.
	Text format	.CSV, .TXT*	Waveform data will be saved in the CSV format while measurement continues. Although the data can be loaded using spreadsheet software, it cannot be loaded by the instrument or the Logger Utility.
Numerical calculation results	Text format	.CSV, .TXT*	Numerical calculation results will be saved after measurement stops.

*: If a setting other than **[Comma]** is selected under **[Delimiter]**, the extension is set to **[.TXT]**.

Text format (CSV) limitations

Auto save is subject to limitations depending on the recording interval.

- Recording interval of 1 ms to 5 ms: Auto save is not supported.
- Recording interval of 10 ms: Auto save is not supported for 61 or more channels.

Data protection (When Z1007 Battery Pack is used)

The instrument will stop saving data when the battery starts to run out during auto-save operation (Measurement will continue).

Media crash, which can occur because of system shutdown during saving operation, can be prevented.

SET > Measure > Auto save

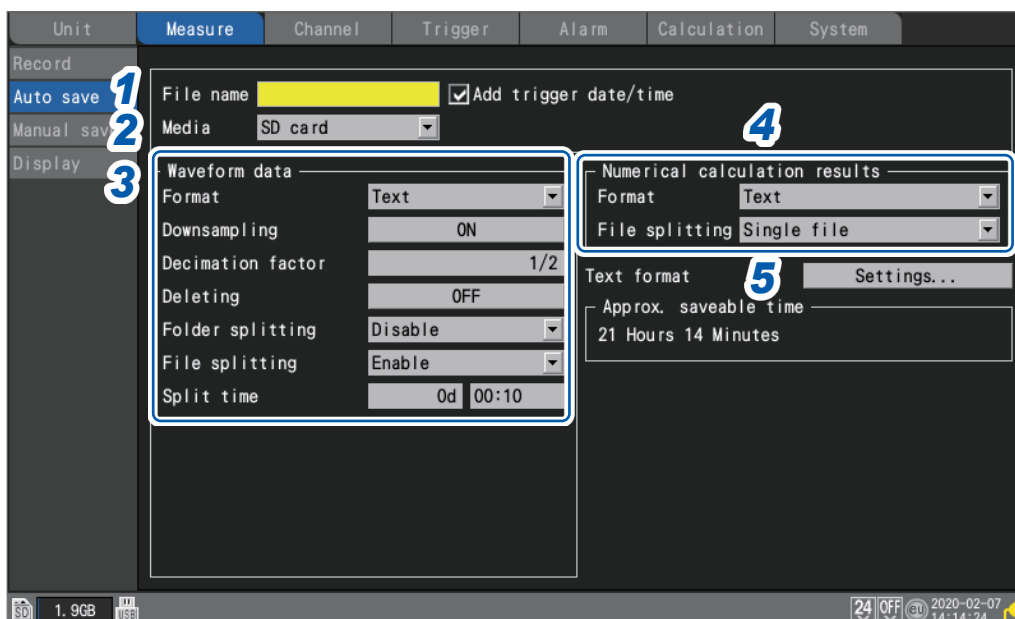

3

Saving and Loading Data

1 Enter the filename to use during auto-save operation in the [File name] field (up to 8 single-byte characters).

See “Text entry method” (p.8).

A serial number beginning from 0001 (in increments of one) will be appended to entered file names.

Example: Filename: [ABC], Format :binary
ABC0001.MEM, ABC0002.MEM, ABC0003.MEM, . . .

Example: Filename: [ABC100], Format: binary
ABC1000001.MEM, ABC1000002.MEM, ABC1000003.MEM, . . .

If you do not specify a filename, a filename will be assigned automatically.

See “When saving files without specifying a filename” (p. 100).

Under [Add trigger date/time], select whether to add date and time to the filename.

<input type="checkbox"/>	Adds the date and time at which the trigger activated to the waveform data filename.
<input checked="" type="checkbox"/>	Does not add the trigger activation date and time the end of the waveform data filename.

When the [Add trigger date/time] check box is selected, the file is named as below.

Entered filename_191224_235959_0001.MEM (when the trigger activated at 23:59:59 on December 24, 2019)

2 Under [Media], select the media to give priority when saving data.

SD card , USB flash drive

When both an SD Memory Card and USB Drive are inserted, the system will save data on the selected media. If the selected media is not inserted, the system will save data on the other media.

3 Under **[Format]** in the **[Waveform data]** area, select the auto save type.

OFF <input checked="" type="checkbox"/>	Does not perform auto-save operation.
Binary	Saves data in the instrument's dedicated format (binary format)
Text	Saves data in text format (.CSV).

(When **[Format]** is set to **[Text]**)

Under **[Downsampling]**, select whether to perform downsampling.

When set to **[ON]**, the size of the saved data file will be reduced.

OFF <input checked="" type="checkbox"/> , ON
--

(When **[Downsampling]** is set to **[ON]**)

Under **[Decimation factor]**, select the decimation factor.

1/2 <input checked="" type="checkbox"/> to 1/100,000
--

Example: If set to **[1/5]**, 1 data point out of every 5 data points will be left.

Under **[Deleting]**, select the type of processing to perform if the media on which data is being saved runs out of space (as necessary).

OFF <input checked="" type="checkbox"/>	Ends auto-save operation.
ON	Deletes the oldest waveform file and continues auto-save operation. If the system is unable to delete a file, it will stop saving data. Numerical calculation results will not be deleted.

Under **[Folder splitting]**, select the timing at which to segment data (as necessary).

The folders in which data is saved can be segmented based on the set period of time.

Disable <input checked="" type="checkbox"/>	Saves in a single folder such files containing data obtained during the amount of time set for recording. The folder will be segmented under the following conditions: <ul style="list-style-type: none"> • When [File splitting] is set to [Disable]: Segments the folder by day. • When the number of files in the folder has reached 1000: Switches the save destination over to folders with a sequential number appended to (for example, 19-12-23_0001).
1 d	Segments folders by day.
1 week	Segments folders by week. A week is defined as lasting from Monday to Sunday.
1 month	Segments folders by month.

Example: If set to **[1 week]**

When measurement started on Sunday, December 29, 2019, the system will regard Monday, December 23, 2019 as the beginning of the week.

The 19-12-23 folder will automatically be created.

Example: If set to **[1 month]**

When measurement started on December 29, 2019, the system will regard December 1, 2019 as the beginning of the month.

The 19-12-01 folder will automatically be created.



Under **[File splitting]**, select the segmentation method (as necessary).

Saved files will be segmented based on the set period of time.

Disable <input checked="" type="checkbox"/>	Creates one waveform file for each measurement. However, files will be segmented automatically if the file size exceeds 1 GB.
Enable	Segments files by the time specified in [Split time] from the start of measurement when saving waveform data. Under [Split time] , set the time by which to segment files. However, files will be segmented automatically if the file size exceeds 1 GB, even if the segmentation time has not yet been reached.

(When **[File splitting]** is set to **[Enable]**)

Under **[Split time]**, set the time by which to segment files.

Day (0 to 30), hour (0 to 23), min. (0 to 59)

4 Under **[Format]** in the **[Numerical calculation results]** area, select the auto save type.

OFF <input checked="" type="checkbox"/>	Does not perform auto-save operation.
Text	Saves data in text format (.CSV).

Under **[File splitting]**, select whether to segment saved files (as necessary).

Single file <input checked="" type="checkbox"/>	Saves all numerical calculation results in one file.
Individual calc	Creates files segmented by calculation item, in addition to the file containing all of the calculations together. A calculation number is appended to such folders. Example: The filename for calculation No. 5 will be AUTO0001_05.CSV

5 Press the **ENTER** key while **[Settings...]** under **[Text format]** is selected.

The settings window will open.

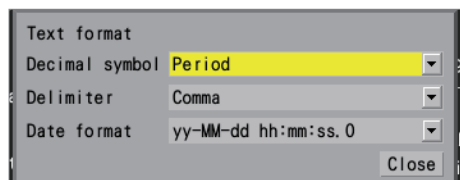

Under **[Decimal symbol]**, select the symbol to use as the decimal point.

Period	Uses a period (".") as the decimal point in numerical values.
Comma	Uses a comma (",") as the decimal point in numerical values.

Both the **[Decimal symbol]** and the **[Delimiter]** settings cannot be set to **[Comma]**.

When you set either **[Decimal symbol]** or **[Delimiter]** to **[Comma]**, the other will automatically switch over to a setting other than **[Comma]**.

Under **[Delimiter]**, select the symbol to use as the delimiter.

The file extension will change depending on the delimiter.

Comma	Uses a comma (",") as the delimiter. (Extension: .CSV)
Space	Uses a space character as the delimiter. (Extension: .TXT)
Tab	Uses a tab character as the delimiter. (Extension: .TXT)
Semicolon	Uses a semicolon (";") as the delimiter. (Extension: .TXT)

You cannot set both **[Decimal symbol]** and **[Delimiter]** to **[Comma]**.

Under [Date format], select the date format.

This setting is available only with [Display horizontal axis] set to [Date].

See “Other display settings” (p.40).

<p>yy-MM-dd hh:mm:ss.0 <input type="checkbox"/></p>	<p>Outputs the date using the following format: YEAR-MONTH-DAY HOURS:MINUTES:SECONDS.MILLISECONDS. Dates output in this format will be treated as comments by spreadsheet software.</p>
<p>yyyy-MM-dd hh:mm:ss + ms</p>	<p>Outputs the date using the following format, and treats time data less than 1 s (unit: ms) as separate data: "YEAR-MONTH-DAY HOURS:MINUTES:SECONDS. Time data less than 1 s in duration will be displayed in a separate column by spreadsheet software. This format is convenient to use when you wish to combine CSV data acquired from different instruments using spreadsheet software.</p>

The date format selected under [Date format] will not apply to trigger times.

Replacing (ejecting) media during real-time save operation

This section describes how to replace media while real-time saving is enabled. It also describes how to check data on media during extended recording.

WAVE

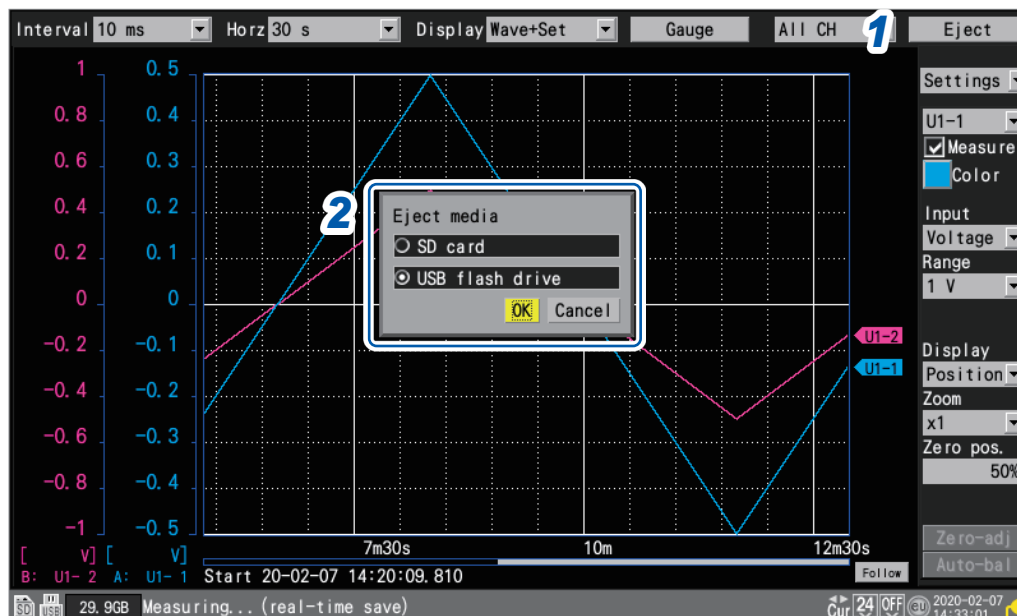

- 1** Press the **ENTER** key while **[Eject]** on the top right of the waveform screen is selected. The media exchange window will be displayed.
- 2** Select the media you wish to eject and press the **ENTER** key while **[OK]** is selected.

SD card , USB flash drive

- 3** Once either **[USB flash drive can be safely removed]** or **[SD card can be safely removed]** has been displayed on the screen, eject the media.
 - Waveform data while the media was ejected is written to the instrument's internal buffer memory.
 - When both an SD Memory Card and a USB Drive are inserted, ejecting the media containing data will switch the save destination over to the other media.
- 4** Insert formatted media.

When you insert media into the instrument, the instrument will save data that has been written to the internal buffer memory to the media, and then resume recording waveform data.

IMPORTANT

- If you do not finish the replacement of media within two minutes after pressing the **ENTER** key with **[Eject]** selected, the internal buffer memory could run out, resulting in data missing.
- When the media is replaced while real-time save operation is in progress, subsequent data will be saved in a different file.
- If measurement stops while the media is ejected, the data until the point at which measurement stopped will not be saved, even if new media is inserted after measurement stopped.
- If **[FTP data auto send]** is on, files that have not sent at the time when the **ENTER** key is pressed with **[Eject]** selected will not be sent.

Manual saving (selective saving, immediate saving)

This section describes how to save data using the **SAVE** key.
 You can select the operation to perform when the **SAVE** key is pressed.

IMPORTANT

- Data can be saved while the instrument does not perform measurement has. Data cannot be saved while measurement is in progress.
- Only data saved in the internal buffer memory (the last 256 Mwords) can be saved. Use auto (real-time) saving if you need to save more than 256 Mwords of data.

SET > **Measure** > **Manual save**

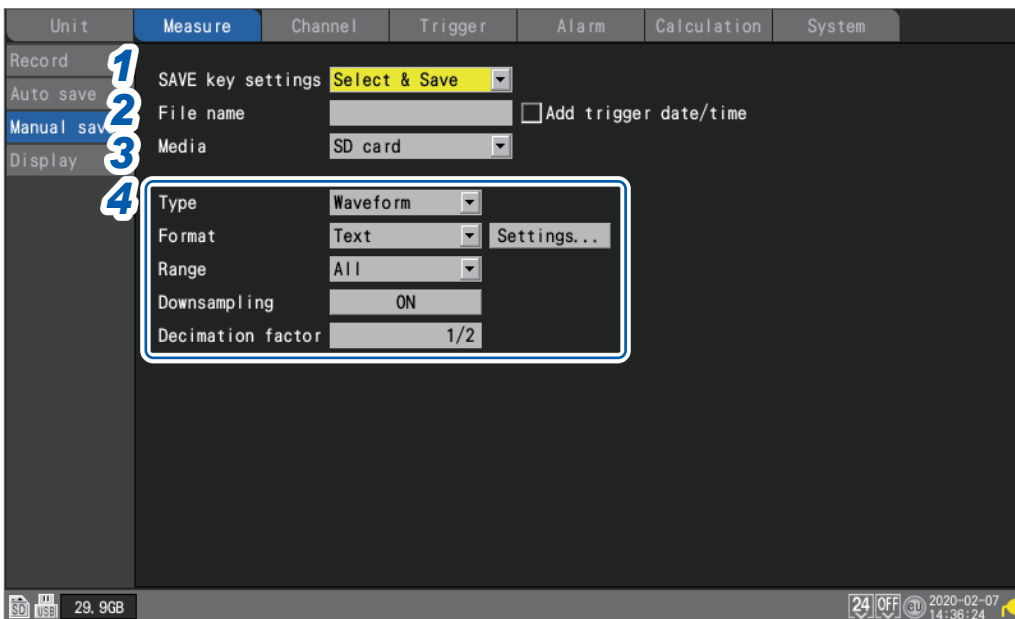

1 Under **[SAVE key settings]**, select the operation to perform when the **SAVE** key is pressed.

Select & Save <input checked="" type="checkbox"/>	Displays the settings window when the SAVE key is pressed. Data will be saved after you select what to save.
Quick save	Saves data immediately when the SAVE key is pressed. The type of data set with [Type] will be saved.

2 Enter the filename to use when saving data in the **[File name]** field (up to 8 single-byte characters).

See "Text entry method" (p.8).

If you do not specify a filename, a filename will be assigned automatically.

See "When saving files without specifying a filename" (p.100).

For more information about file names and **[Add trigger date/time]**, see **[File name]** of selective save (p.114).

3 Under **[Media]**, select the media on which to save data.

SD card , **USB flash drive**

4 Under [Type], select the type of data to save.

Waveform <input type="checkbox"/>	Saves waveform data.
Screen shot	Saves a screen image. (PNG format)
Settings	Saves the instrument's setting conditions.
Calc results	Saves numerical calculation results.

(When [Type] is set to **[Waveform]**)

Under [Format], select the file format.

Binary <input type="checkbox"/>	Saves data in the instrument's dedicated format (binary format). You will be able to load saved data on the instrument and with the Logger Utility.
Text	Saves data in text format. Although you will be able to load data with spreadsheet software, you will not be able to load it on the instrument or with the Logger Utility.

If **[Text]** is selected, configure the text format settings under **[Settings...]**.
See **[Settings...]** of **[Text]** in "Auto save (real-time save)" (p. 109).

(When [Type] is set to **[Waveform]**)

Under [Range], select the range of data to save.

All <input type="checkbox"/>	Saves the waveform for the entire recorded length, without regard to the A/B cursors.
A-B	Saves the waveform between the A and B cursors.
Start-A	Saves the waveform from the beginning to the A cursor.
Start-B	Saves the waveform from the beginning to the B cursor.
A-End	Saves the waveform from the A cursor to the end.
B-End	Saves the waveform from the B cursor to the end.

See "Specifying a waveform range" (p. 77).

(When [Format] is set to **[Text]**)

Under [Downsampling], select whether to perform downsampling.

When set to **[ON]**, the size of the saved data file will be reduced.

OFF <input type="checkbox"/> , ON

(When [Downsampling] is set to **[ON]**)

Under [Decimation factor], select the decimation factor.

1/2 <input type="checkbox"/> to 1/100000
--

Example: If set to **[1/5]**, 1 data point out of every 5 data points will be left.

(When [Type] is set to **[Calc results]**)

Under [File splitting], select whether to segment saved files.

Single file <input type="checkbox"/>	Saves numerical calculation results in a single file.
Individual calc	Saves numerical calculation results in a different file for each numerical calculation.

If the file containing waveform data exceeds 1 GB in size, it will be segmented into multiple one-gigabyte-sized (roughly) files and then saved.

Selective save operation

This section describes how the system works when **[Select & Save]** is selected under **[SAVE key settings]**.

Saving waveform data

1 Press the **SAVE** key.

A window will be displayed.

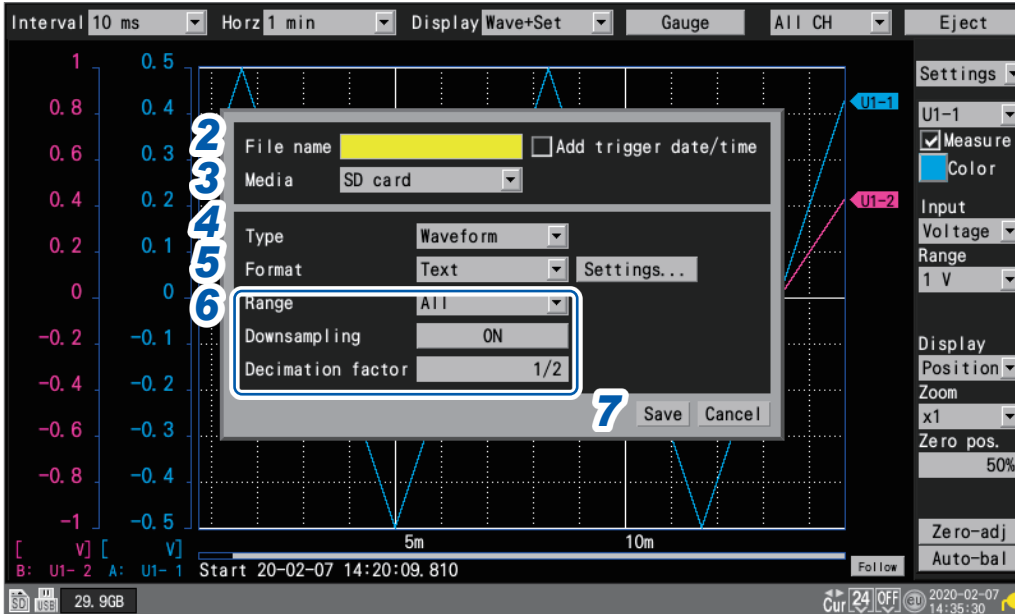

2 Enter the filename in the **[File name]** field (up to 8 single-byte characters).

See “Text entry method” (p.8).

When you enter a file name ending in a letter other than a number, the four-digit number 0001 will be appended to the entered name. This trailing number will increase in increments of one for the subsequent files.

Example: Filename: **[ABC]**, Format :binary

ABC0001.MEM, ABC0002.MEM, ABC0003.MEM, . . .

When you entered a file name ending in a number, the trailing number will increase in increments of one for the subsequent files.

Example: Filename: **[ABC100]**, Format: binary

ABC100.MEM, ABC101.MEM, ABC102.MEM, . . .

If you do not specify a filename, a filename will be assigned automatically.

See “When saving files without specifying a filename” (p.100).

Under **[Add trigger date/time]**, select whether to add date and time to the filename.

<input type="checkbox"/>	Adds the date and time at which the trigger activated to the waveform data filename.
<input checked="" type="checkbox"/>	Does not add the trigger activation date and time the end of the waveform data filename.

When the **[Add trigger date/time]** check box is selected, the file is named as below.

Entered filename_191224_235959_0001.MEM (when the trigger activated at 23:59:59 on December 24, 2019)

3 Under **[Media]**, select the media on which to save data.



4 Under **[Type]**, select **[Waveform]**.

5 Under **[Format]**, select the file format.

Binary <input type="checkbox"/>	Saves data in the instrument's dedicated format (binary format).
Text	Saves data in text format.

If **[Text]** is selected, configure the text format settings while **[Settings...]** is selected. See **[Settings...]** of **[Text]** in "Auto save (real-time save)" (p. 109).

6 Under **[Range]**, select the range of data to save.

All <input type="checkbox"/>	Saves the waveform for the entire recorded length, without regard to the A/B cursors.
A-B	Saves the waveform between the A and B cursors.
Start-A	Saves the waveform from the beginning to the A cursor.
Start-B	Saves the waveform from the beginning to the B cursor.
A-End	Saves the waveform from the A cursor to the end.
B-End	Saves the waveform from the B cursor to the end.

See "Specifying a waveform range" (p. 77).

(When **[Format]** is set to **[Text]**)

Under **[Downsampling]**, select whether to perform downsampling.

When set to **[ON]**, the size of the saved data file will be reduced.

OFF <input type="checkbox"/> , ON

(When **[Downsampling]** is set to **[ON]**)

Under **[Decimation factor]**, select the decimation factor.

1/2 <input type="checkbox"/> to 1/100000
--

Example: If set to **[1/5]**, 1 data point out of every 5 data points will be left.

7 Press the **ENTER** key while **[Save]** is selected.

Waveform data will be saved.

Saving setting conditions, screen images, and numerical calculation results

1 Press the **SAVE** key.

A window will be displayed.

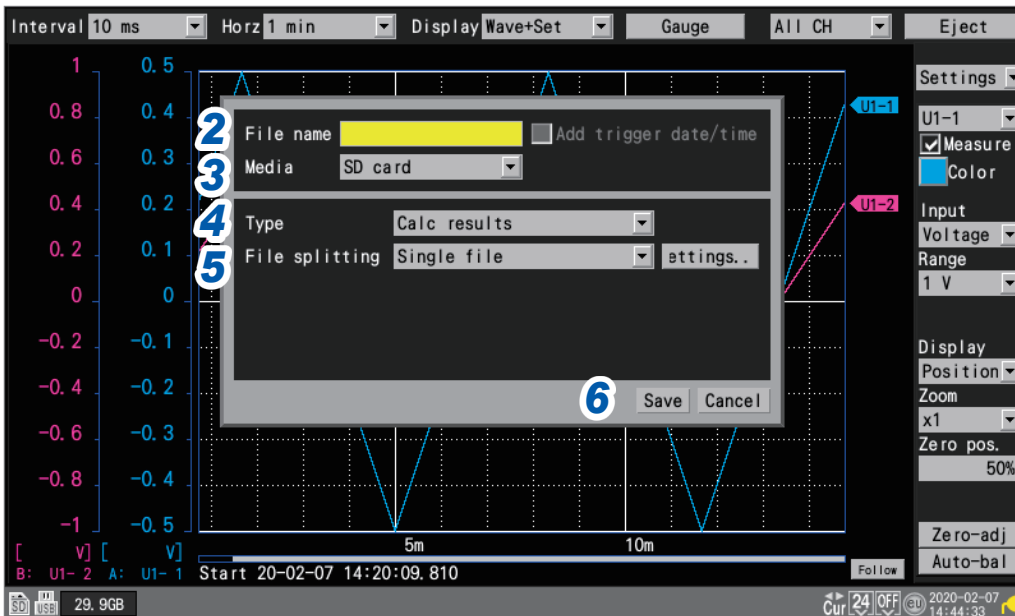

2 Enter the filename in the **[File name]** field (up to 8 single-byte characters).

See **[File name]** in “Saving waveform data” (p.114).

3 Under **[Media]**, select the media on which to save data.

SD card , USB flash drive

4 Under **[Type]**, select the type of data to save.

Settings	Saves the instrument's setting conditions.
Screen shot	Saves the screen at the time the SAVE key is pressed (PNG format).
Calc results	Saves numerical calculation results. (This setting is available only when performing numerical calculations.)

5 (When **[Type]** is set to **[Calc results]**)

Under **[File splitting]**, select whether to segment saved files.

Single file <input checked="" type="checkbox"/>	Saves numerical calculation results in a single file.
Individual calc	Saves numerical calculation results in a different file for each numerical calculation.

Configure the text format settings while **[Settings...]** is selected.

See **[Settings...]** of **[Text]** in “Auto save (real-time save)” (p.109).

6 Press the **ENTER** key while **[Save]** is selected.

The type of data selected in step 4 will be saved.

3.4 Loading Data

This section describes how to load data that has been saved on media (an SD Memory Card or USB Drive).

The instrument can load two types of data:

- Waveform data (binary data)
- Setting conditions

The instrument cannot load waveform data saved in CSV format.

1 Press the **FILE** key.

The file list screen will be displayed.

The file list screen provides a list of folders and files.

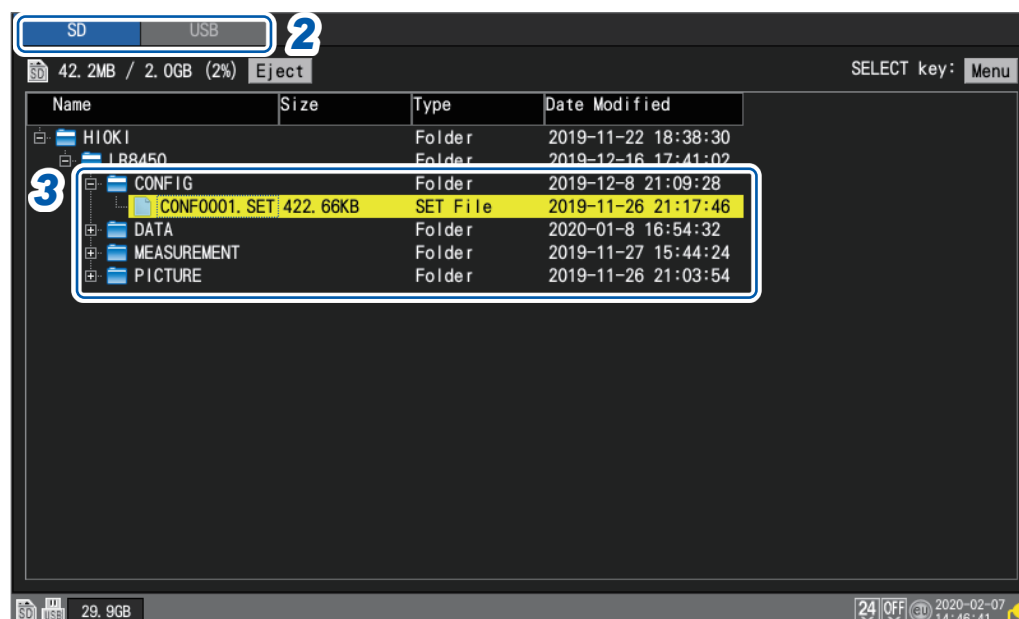

2 Select the media on which the file you wish to load is stored with the **FILE** key.

SD , USB

3 Select the folder containing the data you wish to load with the **Up Arrow** and **Down Arrow** keys and then press the **Right Arrow** key.

CONFIG	Folder containing settings files
DATA	Folder containing waveform files

You can return to the previous folder by pressing the **Left Arrow** key.

4 Select the file you wish to load with the **Up Arrow** and **Down Arrow** keys and then press the **ENTER** key.

A confirmation window will be displayed.

You can load system (environment and external terminal) settings and communications (LAN, USB) settings. Select the checkbox for the settings you wish to load. Settings whose checkbox is not selected will not be loaded.

When loading waveform data, information about the saved waveform data will be displayed.

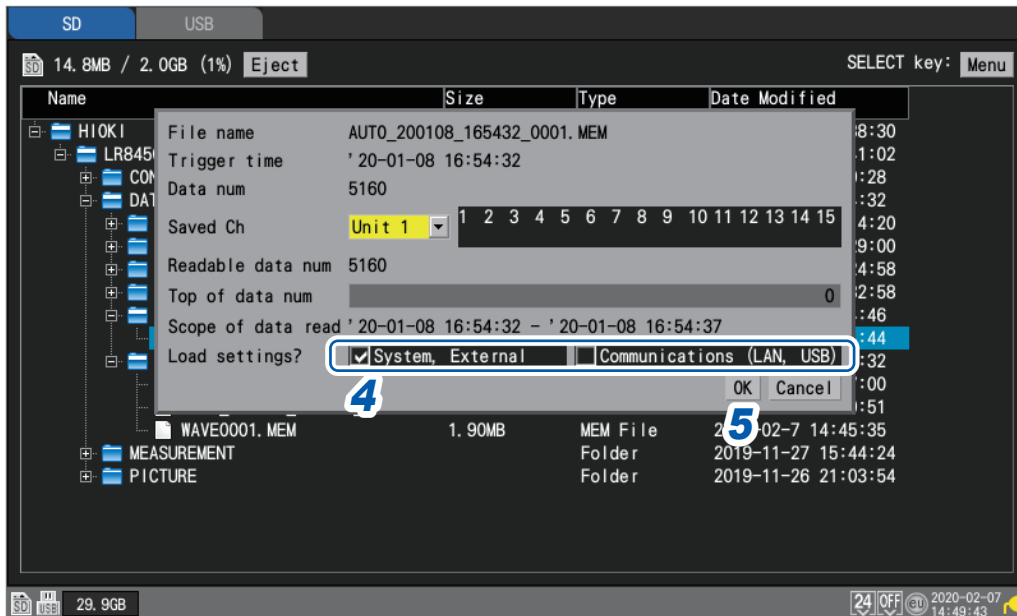

5 Press the **ENTER** key while **[OK]** is selected.

The data will be loaded.

When you load settings data or waveform data, the system will switch to file mode.

Loading waveforms

The confirmation window will include information such as the trigger time and the channel number the data of which is saved.

If the file being loaded is larger than the capacity of the internal buffer memory, specify the start point of the waveform data to load. The system will load the data containing the number of data points specified in **[Readable data num]** starting at the specified point.

File mode

When you load a waveform file or a setting file, the settings in place before the file was loaded will be saved in the instrument's internal memory, and the system will switch to file mode. The color of the status bar will change depending on the file mode state.

Status bar	File mode	Description
Gray	OFF	Data is not being loaded.
Blue	ON	Data for a connected plug-in module was loaded.
Green	ON	Data for module other than the connected plug-in modules was loaded.

When file mode is active (status bar: green)

- The monitor cannot be displayed.
- You can press the **START** key to start measurement after reverting to the settings in place before the file was loaded.

Performing the following operations will cause file mode to be turned off (status bar: gray):

- Starting measurement
- Turning off the instrument
- Pressing the **MONITOR** key (status bar: green)



3.5 Managing Data

This section describes how to manage data stored on an SD Memory Card or USB Drive that has been inserted into the instrument.

The following operations are available:

- Formatting the SD Memory Card or USB Drive (p. 103)
- Loading files (p. 117)
- Moving between folders (p. 120)
- Deleting data (p. 121)
- Renaming files or folders (p. 122)
- Copying data (p. 123)
- Sorting files (p. 124)

Switching media (drives)

This section describes how to select the media (SD Memory Card or USB Drive) on which to perform file operations.

If an SD Memory Card is inserted into the instrument, the screen will display a list of files on the SD Memory Card.

If a USB Drive is inserted into the instrument, the screen will display a list of files on the USB Drive.

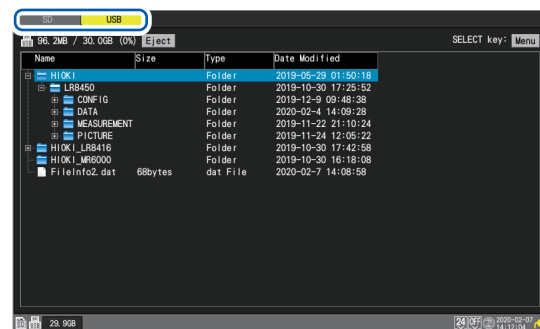
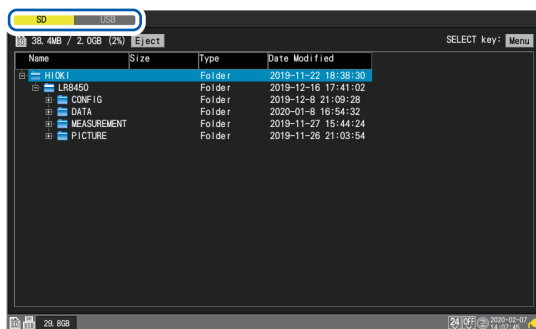

1 Press the **FILE** key.

A screen listing the files on the SD Memory Card or USB Drive will be displayed.

2 Press the **FILE** key.

Each time you press the **FILE** key, the display will switch between the SD Memory Card and the USB Drive.

Moving between levels (folders)

This section describes how to move within folders or to the next higher level.

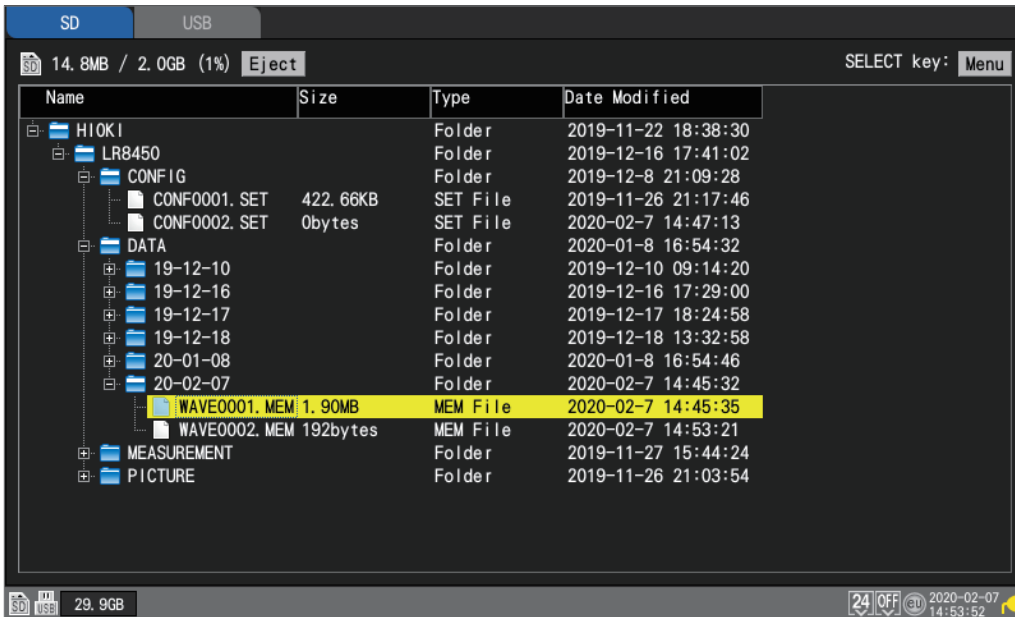

- 1** Press the **Up Arrow** and **Down Arrow** keys to select the folder to which you wish to move.
- 2** Press the **Right Arrow** key.
The system will move to that folder.
- 3** Press the **Left Arrow** key.
The system will move up one level (so that you exit that folder).

Deleting data

This section describes how to delete a file or folder.

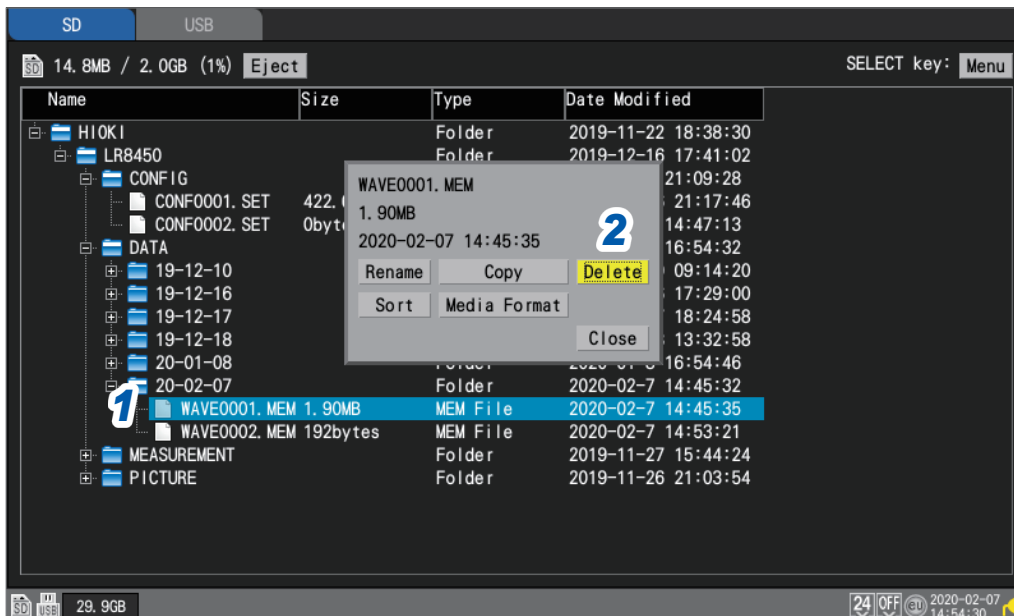

- 1 Select the file or folder you wish to delete with the **Up Arrow** and **Down Arrow** keys and then press the **SELECT** key.

The file operations window will be displayed.

- 2 Press the **ENTER** key while **[Delete]** is selected.

A confirmation window will be displayed.

- 3 Press the **ENTER** key.

The file or folder will be deleted.

To prevent data from being inadvertently deleted, files in the **[HIOKI]**, **[LR8450]**, and **[DATA]** folders cannot be deleted.

Files whose read-only attribute is set cannot be deleted. Those files can be deleted on a computer.

Renaming files and folders

This section describes how to rename a file or folder.

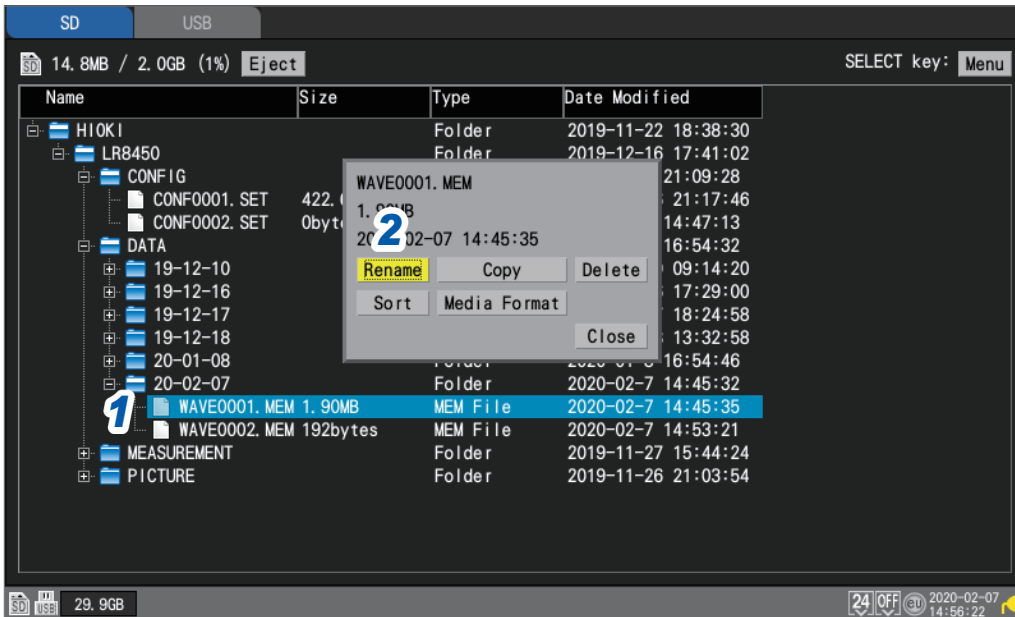

- 1 Select the file or folder you wish to rename with the **Up Arrow** and **Down Arrow** keys and then press the **SELECT** key.

The file operations window will be displayed.

- 2 Press the **ENTER** key while [**Rename**] is selected.

A text entry window will be displayed.

See "Text entry method" (p.8).

- 3 Enter the new name and press the **START** key.

The filename will be changed.

Copying data

This section describes how to copy data and folders between an SD Memory Card and a USB Drive.

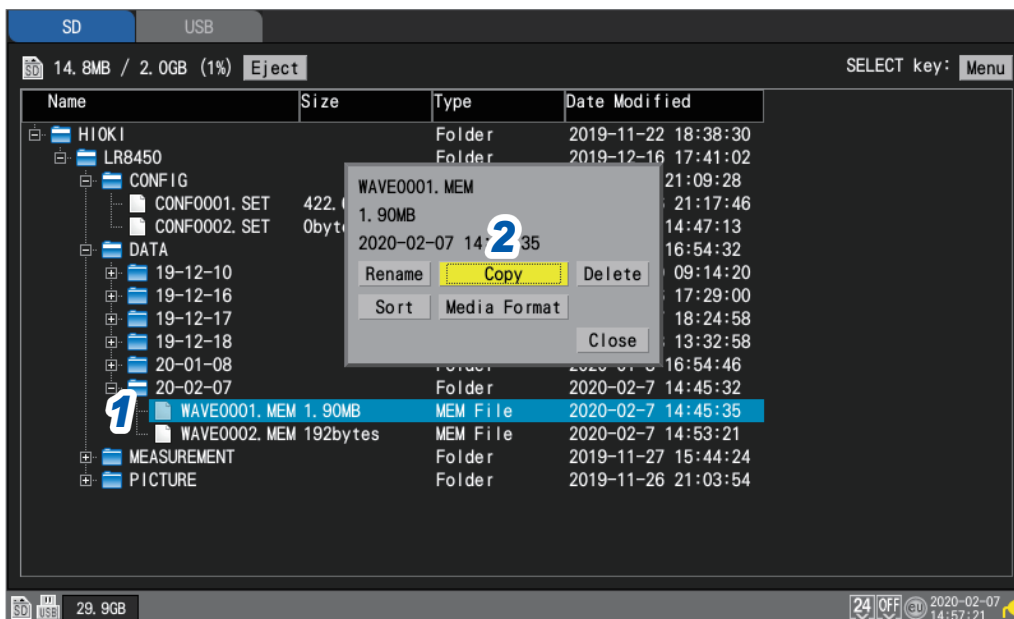

- 1 Select the file or folder you wish to copy with the **Up Arrow** and **Down Arrow** keys and then press the **SELECT** key.

The file operations window will be displayed.

- 2 Press the **ENTER** key while **[Copy]** is selected.

The copy destination window will be displayed.

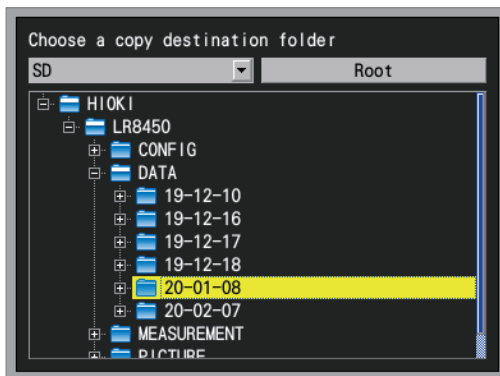

- 3 Select the copy destination media and folder and press the **ENTER** key.

A confirmation window will be displayed.

See "Moving between levels (folders)" (p. 120).

If you select **[Root]**, you can specify the root folder on the media.

- 4 Press the **ENTER** key.

The data will be copied.

You can copy folders up to eight levels deep.

Copying is not available if a file with the same name as the copy source exists at the copy destination.

Sorting files

This section describes how to sort files into ascending or descending order based on their filenames.

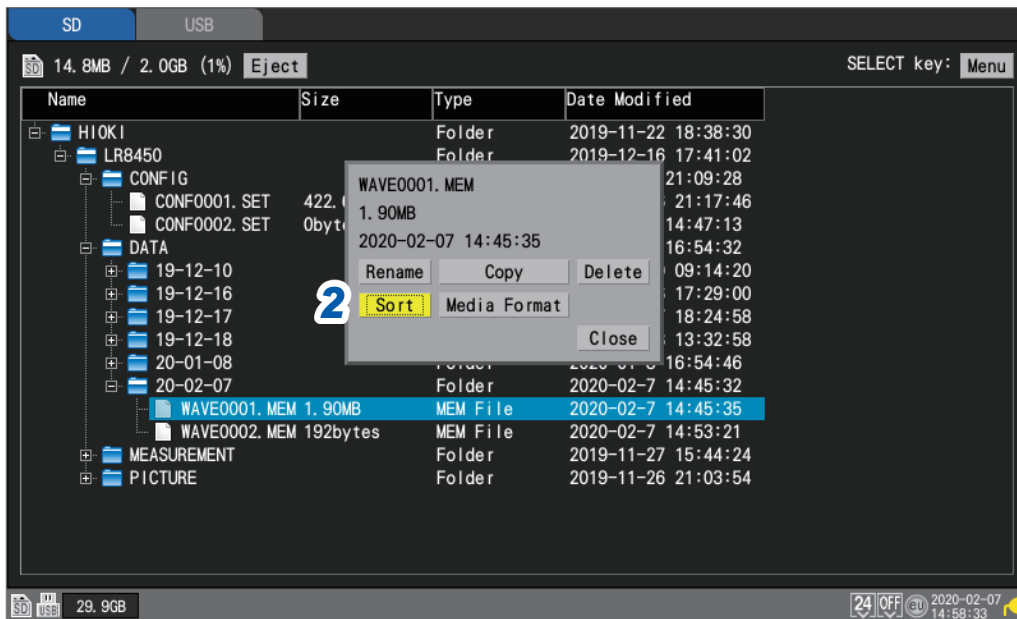

- 1 Display a list of the files you wish to sort and press the **SELECT** key.

The file operations window will be displayed.

- 2 Press the **ENTER** key while **[Sort]** is selected.

A window will be displayed.



- 3 Select the sort method.

Name <input checked="" type="checkbox"/>	Sorts based on filename.
Size	Sorts based on file size.
Type	Sorts based on file type.
Date modified	Sorts based on the file's creation date.

File sorting also applies to files that are not displayed on the screen.

- 4 Select the sort order.

Ascending order , **Descending order**

- 5 Press the **ENTER** key while **[OK]** is selected.

The files will be sorted.

3.6 Acquiring Data with a Computer (PC)

This section describes how to use the included USB cable to load data saved on an SD Memory Card inserted in the instrument onto a computer. “Activating USB drive mode” (p. 126)
You cannot use the included USB cable to load data stored on a USB Drive inserted in the instrument. Instead, insert the USB Drive into a USB connector on the computer to load the data.

Connecting the USB cable

Data on an SD Memory Drive can be loaded by computers running the following operating systems: Windows 7, Windows 8, and Windows 10.

NOTICE

- **Do not unplug the SD Memory Card or USB cable while data is being transferred.**



Doing so may prevent the data from being properly transferred.

- **Ensure the instrument and computer are grounded at the same potential.**

Connecting the USB cable while the ground potentials differ between the instrument and computer could cause the instrument to malfunction or damage it.

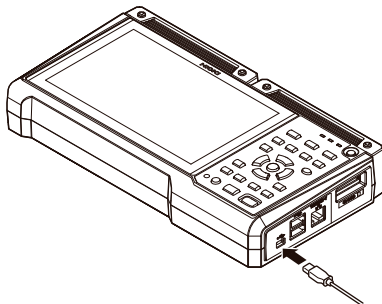

- 1 Insert the USB cable's plug into the instrument's USB cable connector, exercising care to ensure that the plug is oriented properly.**

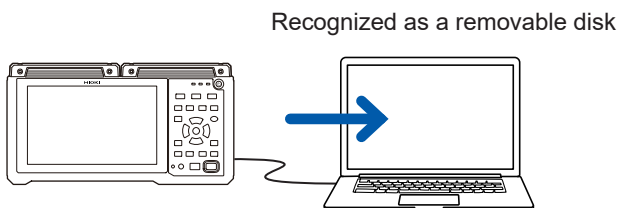

- 2 Connect the other end of the USB cable to the computer's USB connector.**

The SD Memory Card connected to the instrument will be recognized as a removable disk by the computer.

Activating USB drive mode

This section describes how to set the instrument to **[USB drive mode]** in order to communicate with a computer via USB.

SET > **System** > **Comm**

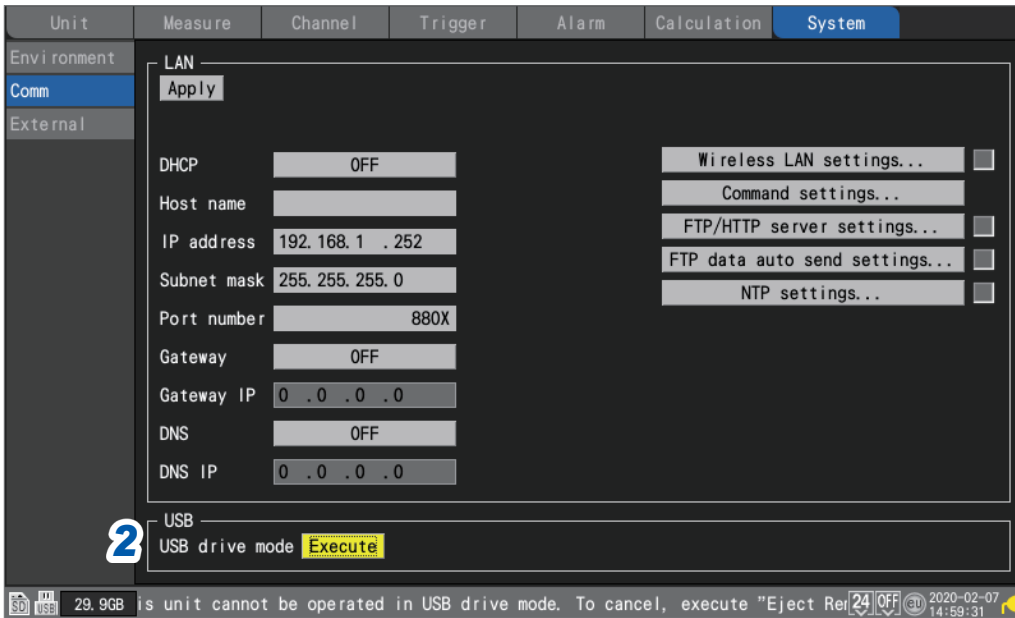

- 1** Connect the **USB** cable.
- 2** Press the **ENTER** key while **[Execute]** under **[USB drive mode]** is selected.
The instrument will switch to **[USB drive mode]**.

The instrument cannot be operated while in USB drive mode.

Canceling USB drive mode

See "Canceling USB drive mode" (p. 127).

Canceling USB drive mode

This section describes how to cancel USB drive mode.

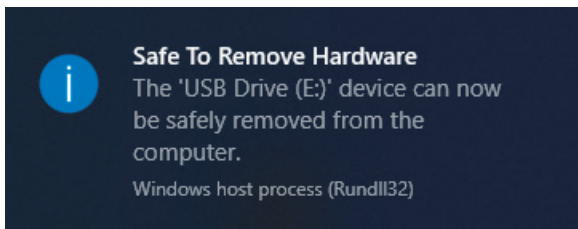
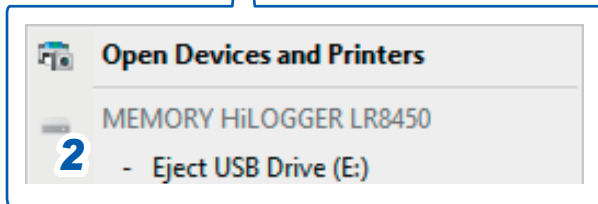
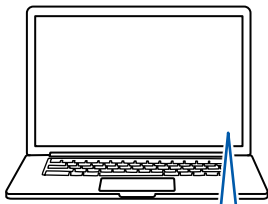

- 1** Click the USB icon shown on the computer's task tray ([**Safely Remove Hardware and Eject Media**]).
- 2** Click [**Eject USB Drive**].

- 3** After the pop-up notification as shown in the left, disconnect the USB cable.

3

Saving and Loading Data





This chapter describes how to set alarm conditions for each measurement channel.

You can have the instrument sound a tone or output an alarm signal to an external device when measurement data satisfies the set condition.

For example, you can output an alarm when the recorded temperature becomes too high.

Alarm signals can be outputted from the external control terminals to external devices.

See “8 External Control (EXT. I/O)” (p. 173).

If an alarm condition is satisfied when measurement starts, the alarm will be output immediately.

4.1 Configuring Alarmsp. 130

Setting shared alarm conditions for all channels..... p. 130

Configuring channel-specific alarm settings..... p. 133

4.2 Checking Alarmsp. 137

IMPORTANT

The logger is unable to detect alarm conditions when there is no data due to an interruption in communication with wireless modules. However, it can detect the alarm condition of the wireless module communication interruption.

When communication is reestablished with the wireless modules, the logger will restore data and detect alarm conditions.

4.1 Configuring Alarms

Setting shared alarm conditions for all channels

This section describes how to set shared alarm conditions that apply to all channels.

SET > **Alarm** > **Common**

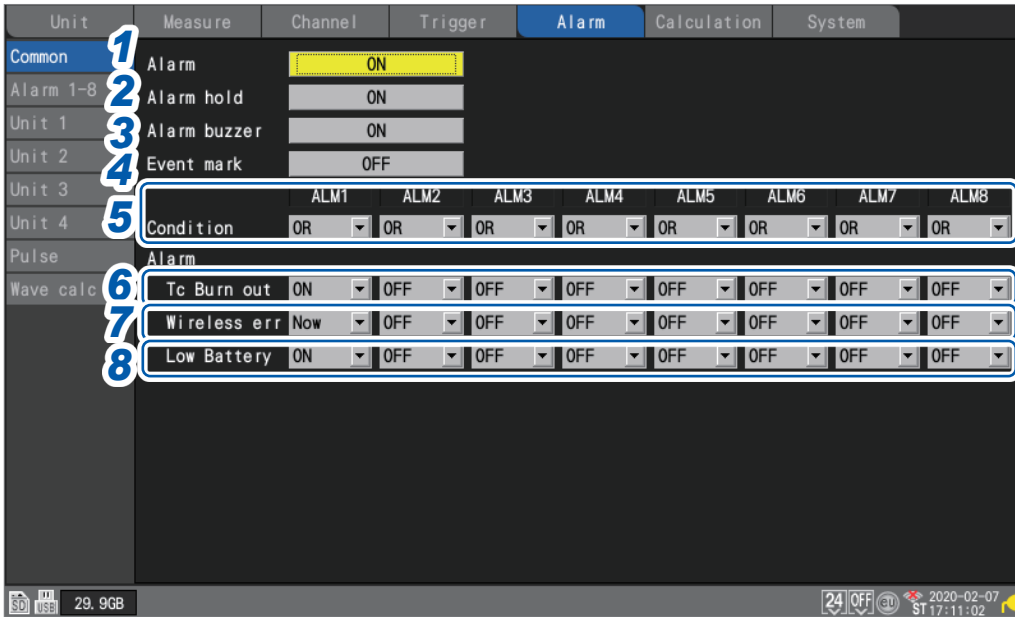

1 Under **[Alarm]**, set the alarm function to **[ON]**.

OFF, ON

2 Under **[Alarm hold]**, select whether to maintain alarm output.

<input checked="" type="checkbox"/> OFF	Stops alarm output once the alarm condition is no longer satisfied. Use this setting when you wish to output an alarm only while the alarm condition is satisfied.
<input type="checkbox"/> ON	Once an alarm is output, maintains (continue) the alarm output until measurement stops. Use this setting when you wish to maintain (continue) alarm output even if the alarm condition is no longer satisfied (i.e., even if conditions have returned to normal).

3 Under **[Alarm buzzer]**, select whether to sound an alarm tone when alarm output occurs.

OFF, ON

4 Under **[Event mark]**, select whether to assign an event mark when an alarm occurs.

OFF, ON

See “5.3 Assigning Event Marks When Alarms Occur” (p. 142).

5 Under **[Condition]** for each alarm output (**[ALM1]** to **[ALM8]**), select the alarm condition.

OR <input checked="" type="checkbox"/>	Outputs an alarm when any of the alarm conditions that have been set for the channels is satisfied.
AND	Outputs an alarm when all of the alarm conditions that have been set for the channels are satisfied.

6 Under **[Tc Burn out]** for each alarm output (**[ALM1]** to **[ALM8]**), select whether to output an alarm when a thermocouple wire break is detected.

You can use the wire break detection when **[Burn out]** is set to **[ON]**.

See “Measuring temperature (with thermocouples)” (p.21).

This type of alarm is output without regard to other alarm conditions (AND/OR logic).

OFF <input checked="" type="checkbox"/> , ON
--

7 Under **[Wireless err]** for each alarm output (**[ALM1]** to **[ALM8]**), select whether to output an alarm when communication with the wireless module is interrupted.

This type of alarm is output without regard to other alarm conditions (AND/OR logic).

OFF <input checked="" type="checkbox"/>	Does not output an alarm, even if communication is interrupted.
Now	Outputs an alarm immediately if communication is interrupted.
3min	Outputs an alarm once communication has been interrupted for 3 min.

8 Under **[Low Battery]** for each alarm output (**[ALM1]** to **[ALM8]**), select whether to output an alarm when the instrument battery or a wireless module battery has low remaining charge.

This type of alarm is output without regard to other alarm conditions (AND/OR logic).

OFF <input checked="" type="checkbox"/> , ON
--

SET > Alarm > Alarm 1-8



Configure each alarm channel ([ALM1] to [ALM8]).

1 Select the waveform display color.

× (OFF), 24 colors

2 Under [Filter], select the number of data points.

The system will output an alarm if the alarm state continues for the set number of data points.

OFF , 2, 5, 10, 20, 50, 100, 200, 500, 1000

3 Under [Comment], enter a comment (as necessary).

See "Text entry method" (p.8).

Configuring channel-specific alarm settings

This section describes how to configure alarm functionality for individual channels.

SET > **Alarm** > **[Unit n]** (n = 1, 2, ...)

Settings list screen

Unit	Measure	Channel	Trigger	Alarm	Calculation	System			
Common									
Copy...									
Alarm 1-8									
Unit 1	U1-1	ALM1 Level	ALM2 Window	ALM3 Slope	ALM4 OFF	ALM5 OFF	ALM6 OFF	ALM7 OFF	ALM8 OFF
Unit 2	U1-2	OFF	OFF	OFF	OFF	OFF	OFF	OFF	OFF
Unit 3	U1-3	OFF	OFF	OFF	OFF	OFF	OFF	OFF	OFF
Unit 4	U1-4	OFF	OFF	OFF	OFF	OFF	OFF	OFF	OFF
Pulse	U1-5	OFF	OFF	OFF	OFF	OFF	OFF	OFF	OFF
Wave calc	U1-6	OFF	OFF	OFF	OFF	OFF	OFF	OFF	OFF
	U1-7	OFF	OFF	OFF	OFF	OFF	OFF	OFF	OFF
	U1-8	OFF	OFF	OFF	OFF	OFF	OFF	OFF	OFF
	U1-9	OFF	OFF	OFF	OFF	OFF	OFF	OFF	OFF
	U1-10	OFF	OFF	OFF	OFF	OFF	OFF	OFF	OFF
	U1-11	OFF	OFF	OFF	OFF	OFF	OFF	OFF	OFF
	U1-12	OFF	OFF	OFF	OFF	OFF	OFF	OFF	OFF
	U1-13	OFF	OFF	OFF	OFF	OFF	OFF	OFF	OFF
	U1-14	OFF	OFF	OFF	OFF	OFF	OFF	OFF	OFF
	U1-15	OFF	OFF	OFF	OFF	OFF	OFF	OFF	OFF



- 1 Press the **ENTER** key while **[Un-m]** (m = 1, 2, ...) for the channel you wish to set is selected. A window with channel-specific alarm settings will open.

Individual settings window

2 Configure alarm settings for each channel you wish to monitor ([ALM1] to [ALM8]).

Alarm type	Setting description		Operation	Description
OFF <input checked="" type="checkbox"/>	-		-	Disables the alarm function.
Level	Slope	<input checked="" type="checkbox"/> ↑, ↓		Outputs an alarm when the measurement data is greater than or equal to the specified level.
	Level	Enter a value.		
Window	Direction	<input checked="" type="checkbox"/> IN, <input type="checkbox"/> OUT	<p>[IN]</p>	<p>Outputs an alarm when the measurement data falls inside the specified range. As well, an alarm is outputted when the waveform equals the upper limit while falling and the lower limit while rising.</p> <p>Outputs an alarm when the measurement data falls outside the specified range. However, an alarm is not outputted when the waveform equals the upper limit while rising or the lower limit while falling.*</p>
	Upper and lower limit values	Enter values.	<p>[OUT]</p>	
Slope	Level	Enter a value.		Outputs an alarm when the measurement data change rate exceeds the specified change rate per unit time (level/time) during the set time interval.
	Time	Set a time.		

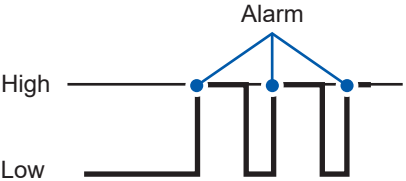
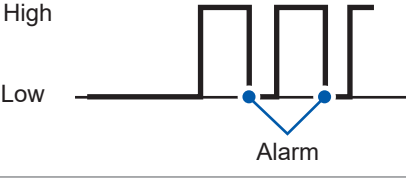
*: For pulse channels, only when the level value is set at zero, an alarm is outputted when the pulse equals zero while falling.

Alarm type	Setting description	Operation	Description	
Pattern	Level	1, 0, X <input checked="" type="checkbox"/>	[1] 	Outputs an alarm when the logic signal is 1 (high).
		[0]		Outputs an alarm when the logic signal is 0 (low).
		[X]		Not used in alarm judgments. Ignores the signal.

4

Alarm (Alarm Output)

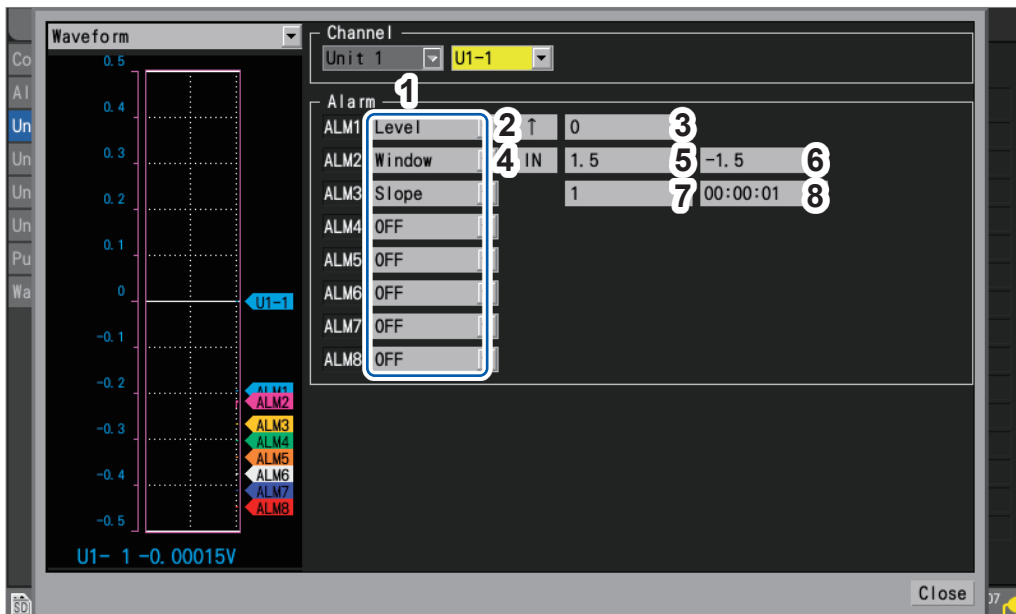

1	Alarm type
2	Slope for Alarm [Level]
3	Level for Alarm [Level]*
4	Direction for Alarm [Window]

5	Upper limit value for Alarm [Window]*
6	Lower limit value for Alarm [Window]*
7	Level for Alarm [Slope]*
8	Time for Alarm [Slope]

*: The instrument expresses strain in terms of micro epsilon ($\mu\epsilon$). You do not need to enter the SI prefix micro (μ).

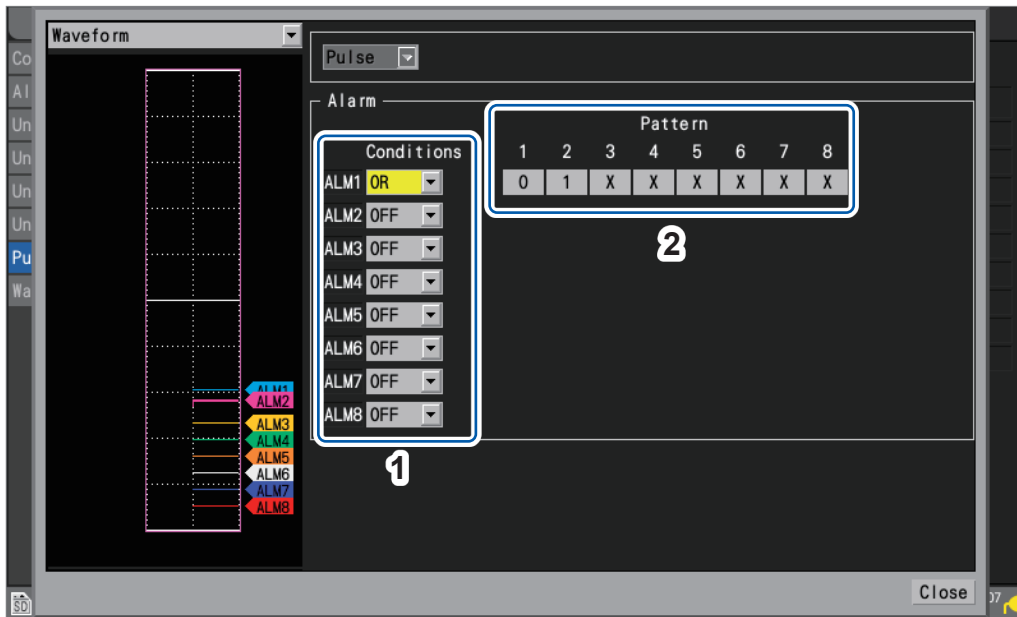

- | | | | |
|----------|-----------------------------|----------|----------------------------------|
| 1 | Alarm activation conditions | 2 | Level for Alarm [Pattern] |
|----------|-----------------------------|----------|----------------------------------|

3 (When **[Logic]** has been set for **[PULSE 1]** to **[PULSE 8]**)
 Under **[Conditions]**, select the condition for activating the alarm.

OFF	Does not use alarms based on logic signals.
OR	Outputs an alarm when any of the patterns is satisfied.
AND	Outputs an alarm when all of the patterns are satisfied.

4.2 Checking Alarms

This section describes how to check whether any alarms have occurred on the **[Alarm]** screen.

1 Press the **WAVE** key several times to display the **[Alarm]** screen.

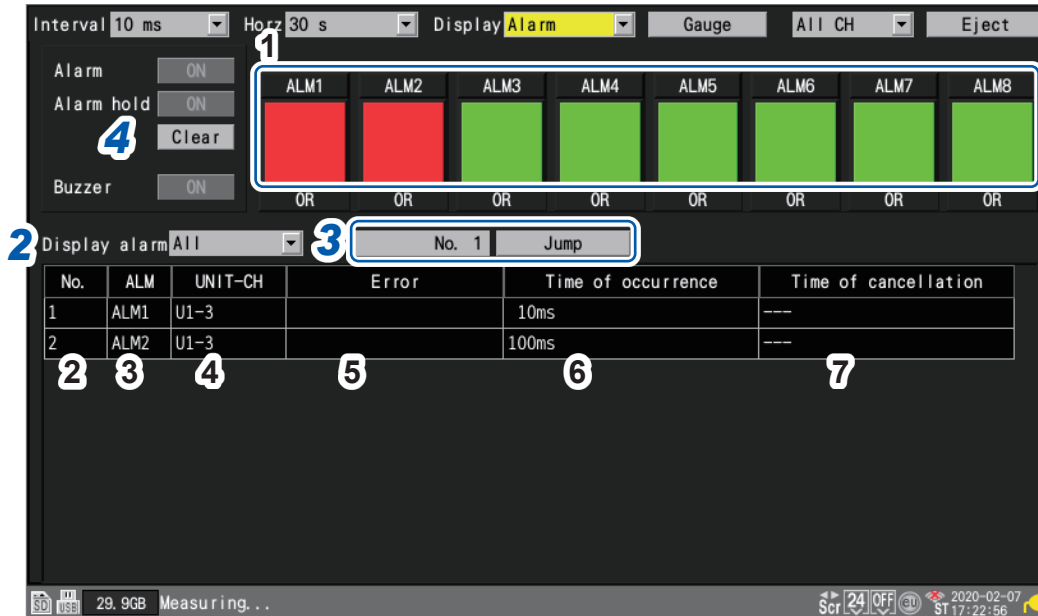

4

Alarm (Alarm Output)

1	ALM1 to ALM8	Red: Alarm output; Green: No alarm output
2	No.	Alarm memory number (assigned in order that alarms occur, starting with 1)
3	ALM	Alarm number (ALM1 to ALM8)
4	UNIT-CH	Module and channel number
5	Error	Type of error (thermocouple wire break, wireless communications error, low battery)
6	Time of occurrence	Time at which the alarm occurred
7	Time of cancellation	Time at which the alarm was cleared

- The alarm memory stores up to 100 alarms.
- The communication interruption log (event record) is maintained regardless of alarm settings.
- Alarms occurring after the start of measurement are recorded in the log.

2 Under **[Display alarm]**, select the alarm number for which you wish to display an alarm history.

The history for the selected alarm number (**[ALM1]** to **[ALM8]**) will be displayed.



To display all alarms, select **[ALL]**.

Scroll through the alarm history using the **SCROLL/CURSOR** keys.

3 (When you wish to review the waveform from when the alarm occurred)

Specify the alarm memory number and press the **ENTER** key while **[Jump]** is selected.

The waveform starting at the time the specified alarm occurred will be displayed.

4 (When you wish to manually clear an alarm)

With **[Alarm hold]** is set to **[ON]**, press the **ENTER** key while **[Clear]** is selected.

Alarms cannot be cleared while the associated alarm conditions remain satisfied.

For more information about the **[Alarm]**, **[Alarm hold]**, and **[Alarm buzzer]** settings, see “4.1 Configuring Alarms” (p. 130).

5 Marking Functionality



This chapter describes how to assign event marks to waveforms during measurement. (Up to 1000 marks can be assigned.) You can also search for event marks and jump to their display positions. Event marks can be assigned by means of the following four methods:

- Pressing the **START** key during measurement
- Tapping the **[Mark]** button on the screen during measurement
- Inputting a signal to external control terminal **I/O 1** to **I/O 3** during measurement
- Configuring the event mark setting so that an event mark is entered responding to alarm

5.1 Assigning Event Marks during Measurement.....	p. 140
5.2 Assigning Event Marks with an External Signal.....	p. 141
5.3 Assigning Event Marks When Alarms Occur.....	p. 142
5.4 Searching for Event Marks	p. 143
5.5 Reviewing Events in CSV Data.....	p. 144

5.1 Assigning Event Marks during Measurement

Assigning event marks to coincide with operation of the measurement target during measurement can help facilitate later analysis.

You can then review how the waveform changed when the measurement target performed certain operations.

When you press the **START** key during measurement, the **[▼]** marks and numbers will appear on the top of the screen. You can assign up to 1000 event marks for a measurement process.

When another measurement process starts, the event numbers will be reset.

The following procedure describes how to assign event marks.

- 1 Press the **WAVE** key to display the **[Wave+Set]** screen.

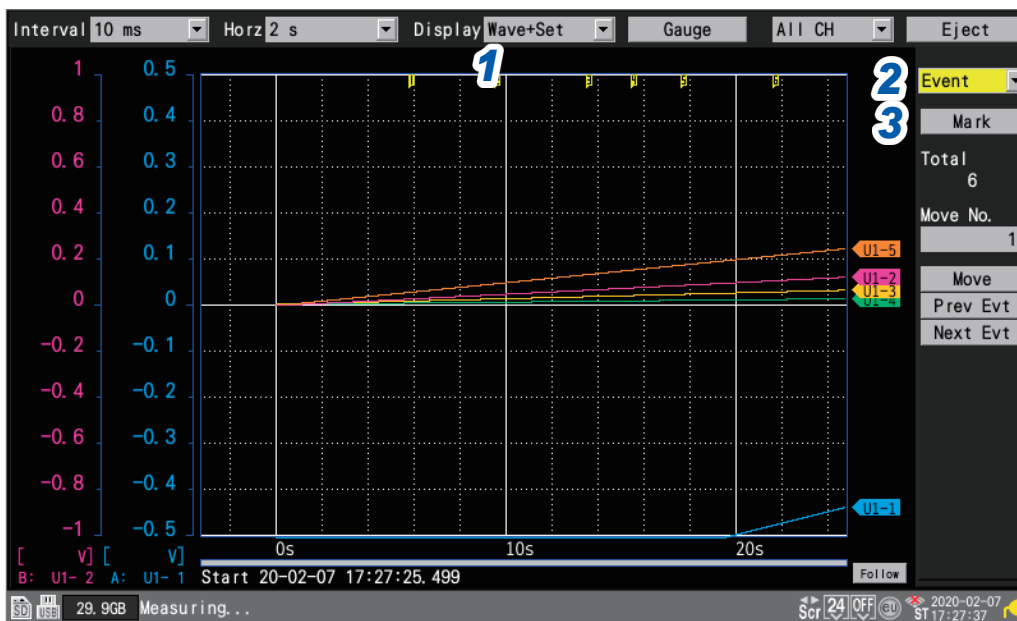

- 2 Under **[Settings]**, select **[Event]**.

A number of event mark settings will be displayed.

- 3 Press the **ENTER** key while **[Mark]** is selected.

An event mark and number will appear at the top of the screen.

Press the **ENTER** key when you wish to assign the event mark.



5.2 Assigning Event Marks with an External Signal

You can assign event marks by inputting external signals. This function must be configured before measurement begins.

SET > **System** > **External**

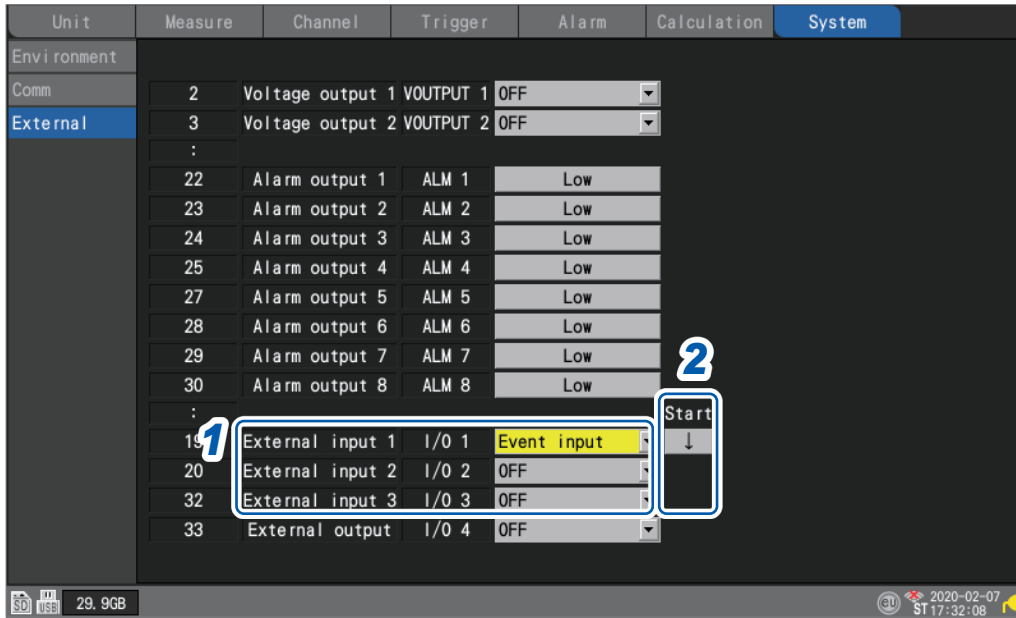

- 1** Under **[External input 1]** to **[External input 3]**, select **[Event input]**.
- 2** Under **[Start]**, select the slope at which to assign the event mark.

↑	Assigns the event mark at the pulse's rising edge.
↓	Assigns the event mark at the pulse's falling edge.

- 3** Input the pulse to the input terminal (I/O 1 to I/O 3) with the **[Event input]** setting. An event mark and number will be assigned at the edge of the entered pulse.

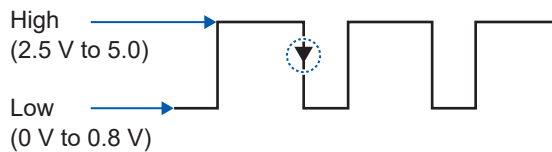

See “External control connections” in the Quick Start Manual and “8 External Control (EXT. I/O)” (p. 173).

5.3 Assigning Event Marks When Alarms Occur

This section describes how to assign event marks when alarms occur.
This function must be configured before measurement begins.

SET > **Alarm** > **Common**

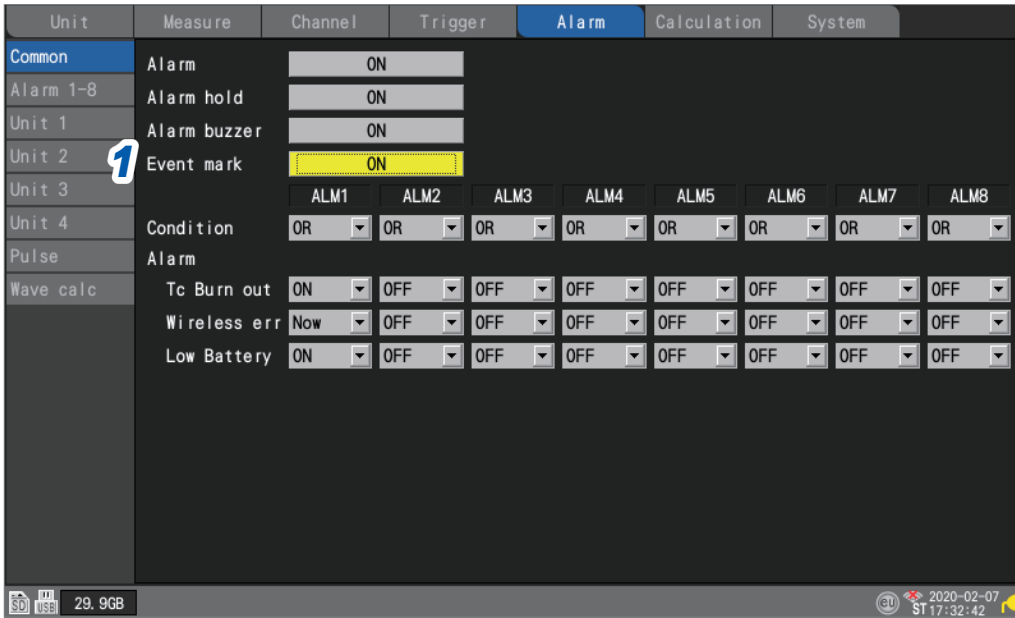

- Under **[Event mark]**, select whether to add an event mark when an alarm occurs.

OFF , **ON**

If you set it to **[ON]**, an event mark and number will be assigned when an alarm occurs.

See "4 Alarm (Alarm Output)" (p. 129).

5.4 Searching for Event Marks

This section describes how to search for the desired event mark and jump to its position.

- 1 Press the **WAVE** key to display the **[Wave+Set]** screen.

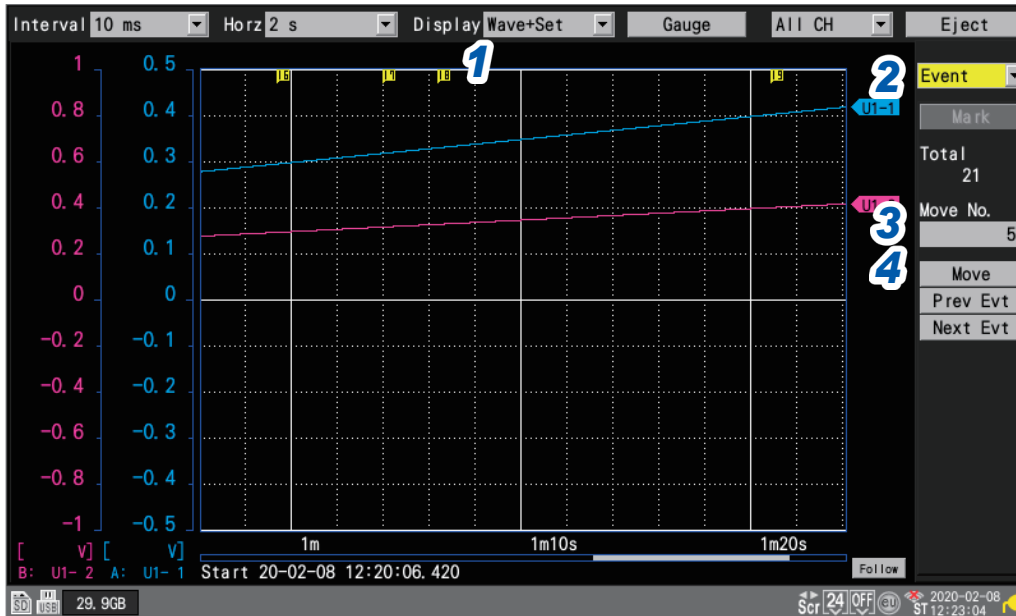

- 2 Under **[Settings]**, select **[Event]**.
A number of event mark settings will be displayed.
- 3 Under **[Move No.]**, specify the number of the event mark to which you wish to jump.
- 4 Press the **ENTER** key while **[Move]** is selected.
The display will move to the event mark specified with **[Move No.]**.

Searching without specifying an event number

- Press the **ENTER** key while **[Prev Evt]** is selected.
The system will search for the event mark with the previous number.
- Press the **ENTER** key while **[Next Evt]** is selected.
The system will search for the event mark with the next number.

5.5 Reviewing Events in CSV Data

When you save waveform data in CSV (text) format with the instrument, event numbers will be included next to the measurement data.

You can review which events were associated with which data values.

											Event no.
File name	AUTO191:V09-C06										
Title comment											
Trigger Time	19-12-09 19:12:18.447										
CH	U1-1	U1-2	U1-3	U1-4	U1-5	U1-6	U1-7	U1-8	U1-9	U1-10	
Mode	Voltage	Voltage	Voltage	Voltage	Voltage	Voltage	Voltage	Voltage	Voltage	Voltage	
Range	100mV	100mV	100mV	100mV	100mV	100mV	100mV	100mV	100mV	100mV	
UnitID											
Comment											
Scaling	OFF	OFF	OFF	OFF	OFF	OFF	OFF	OFF	OFF	OFF	
Ratio	1.00E+00	1.00E+00	1.00E+00	1.00E+00	1.00E+00	1.00E+00	1.00E+00	1.00E+00	1.00E+00	1.00E+00	
Offset	0.00E+00	0.00E+00	0.00E+00	0.00E+00	0.00E+00	0.00E+00	0.00E+00	0.00E+00	0.00E+00	0.00E+00	
Time	U1-1 [V]	U1-2[V]	U1-3[V]	U1-4[V]	U1-5[V]	U1-6[V]	U1-7[V]	U1-8[V]	U1-9[V]	U1-10[V]	Event
0.00E+00	-2.40E-04	-3.08E-03	-2.80E-03	-6.14E-03	-5.00E-04	-7.56E-03	-6.30E-04	-6.16E-03	-3.32E-03	-2.56E-03	0
1.00E+00	-2.40E-04	-3.67E-03	-2.42E-03	-6.50E-03	-2.85E-04	-7.62E-03	-7.60E-04	-5.71E-03	-3.73E-03	-2.33E-03	0
2.00E+00	-2.40E-04	-4.18E-03	-2.08E-03	-6.70E-03	-1.85E-04	-7.48E-03	-1.19E-03	-5.29E-03	-4.21E-03	-1.82E-03	0
3.00E+00	-2.40E-04	-4.98E-03	-1.64E-03	-7.10E-03	-1.00E-04	-7.34E-03	-1.37E-03	-4.80E-03	-4.92E-03	-1.54E-03	0
4.00E+00	-2.40E-04	-5.73E-03	-1.31E-03	-7.27E-03	-1.85E-04	-7.09E-03	-2.07E-03	-4.28E-03	-5.43E-03	-1.11E-03	1
5.00E+00	-2.40E-04	-6.34E-03	-9.55E-04	-7.54E-03	-2.15E-04	-6.89E-03	-2.62E-03	-3.98E-03	-6.09E-03	-8.80E-04	0
6.00E+00	-2.40E-04	-6.78E-03	-6.40E-04	-7.60E-03	-4.05E-04	-6.41E-03	-2.99E-03	-3.11E-03	-6.38E-03	-4.55E-04	0
7.00E+00	-2.40E-04	-7.27E-03	-3.05E-04	-7.62E-03	-6.00E-04	-6.02E-03	-3.47E-03	-2.56E-03	-6.65E-03	-2.70E-04	2
8.00E+00	-2.40E-04	-7.50E-03	-1.65E-04	-7.53E-03	-8.40E-04	-5.49E-03	-3.95E-03	-2.14E-03	-6.96E-03	-4.50E-04	0
9.00E+00	-2.40E-04	-7.89E-03	-1.50E-05	-7.48E-03	-1.22E-03	-5.11E-03	-4.41E-03	-1.74E-03	-7.26E-03	-4.00E-04	0
1.00E+01	-2.40E-04	-8.14E-03	-7.00E-05	-7.24E-03	-1.42E-03	-4.59E-03	-5.08E-03	-1.41E-03	-7.49E-03	4.00E-04	3
1.10E+01	-2.40E-04	-8.31E-03	-3.50E-05	-7.09E-03	-1.85E-03	-4.26E-03	-5.39E-03	-1.17E-03	-7.59E-03	-4.00E-04	0
1.20E+01	-2.40E-04	-8.40E-03	-1.05E-04	-6.75E-03	-2.37E-03	-3.82E-03	-5.85E-03	-8.15E-04	-7.76E-03	-8.50E-04	4
1.30E+01	-2.40E-04	-8.47E-03	-2.60E-04	-6.48E-03	-2.78E-03	-3.25E-03	-6.21E-03	-5.90E-04	-7.88E-03	-3.35E-04	0
1.40E+01	-2.40E-04	-8.29E-03	-4.85E-04	-6.08E-03	-3.36E-03	-2.53E-03	-6.62E-03	-2.40E-04	-7.86E-03	-5.45E-04	0
1.50E+01	-2.40E-04	-8.22E-03	-7.40E-04	-5.49E-03	-3.77E-03	-2.13E-03	-6.93E-03	-1.60E-04	-7.80E-03	-8.60E-04	5
1.60E+01	-2.40E-04	-7.78E-03	-1.19E-03	-4.92E-03	-4.51E-03	-1.61E-03	-7.33E-03	0.00E+00	-7.59E-03	-1.27E-03	0
1.70E+01	-2.40E-04	-7.38E-03	-1.65E-03	-4.35E-03	-5.22E-03	-1.17E-03	-7.58E-03	-3.50E-05	-7.23E-03	-1.93E-03	0
1.80E+01	-2.40E-04	-6.69E-03	-2.36E-03	-3.68E-03	-5.85E-03	-7.25E-04	-7.82E-03	-1.50E-04	-6.88E-03	-2.49E-03	0
1.90E+01	-2.35E-04	-6.07E-03	-2.94E-03	-2.77E-03	-6.38E-03	-3.45E-04	-7.81E-03	-4.60E-04	-6.33E-03	-3.22E-03	0
2.00E+01	-2.35E-04	-5.03E-03	-3.74E-03	-2.06E-03	-6.82E-03	-3.00E-05	-7.80E-03	-8.30E-04	-5.64E-03	-3.80E-03	0
2.10E+01	-2.35E-04	-4.16E-03	-4.51E-03	-1.49E-03	-7.29E-03	3.00E-05	-7.48E-03	-1.33E-03	-4.82E-03	-4.92E-03	6
2.20E+01	-2.35E-04	-3.18E-03	-5.33E-03	-9.40E-04	-7.65E-03	3.00E-05	-7.13E-03	-2.09E-03	-4.22E-03	-5.52E-03	0
2.30E+01	-2.35E-04	-2.22E-03	-6.02E-03	-4.95E-04	-7.75E-03	-2.20E-04	-6.59E-03	-2.89E-03	-3.17E-03	-6.17E-03	0

Numerical and Waveform Calculations



The instrument can perform numerical and waveform calculations.

You can use numerical calculations to calculate values such as the maximum value and minimum value for measured waveforms.

Waveform calculation functionality allows you to perform calculations on waveforms, for example by adding or multiplying waveforms from different channels.

6.1 Performing Numerical Calculations.....p. 146

- Configuring numerical calculations..... p. 147
- Real-time numerical calculations (automatic calculations)..... p. 150
- Numerical calculations after measurement (manual calculations) p. 151
- Partial numerical calculations..... p. 152
- Numerical calculation formulas p. 153

6.2 Performing Waveform Calculations.....p. 155

6.1 Performing Numerical Calculations

There are two methods for performing numerical calculations:

- Performing calculations during measurement (real-time automatic calculations)
 Configure the desired numerical calculations and start measurement. Calculations will then be performed in real time during measurement.
 You can review the most recent numerical calculation results on the **[Wave+Value]** waveform screen.
- Performing calculations after measurement (manual calculations)
 Use the instrument's control keys to start the calculation after measurement has completed.

Performing calculations during measurement (Real-time automatic calculations)

Numerical calculation settings are configured before starting measurement. Calculations are performed in real time during measurement.
 (p. 150)

- You can review the most recent calculated values on the waveform screen (**[Wave+Value]** display).
- You can also save calculated values for each interval in text (CSV) format.

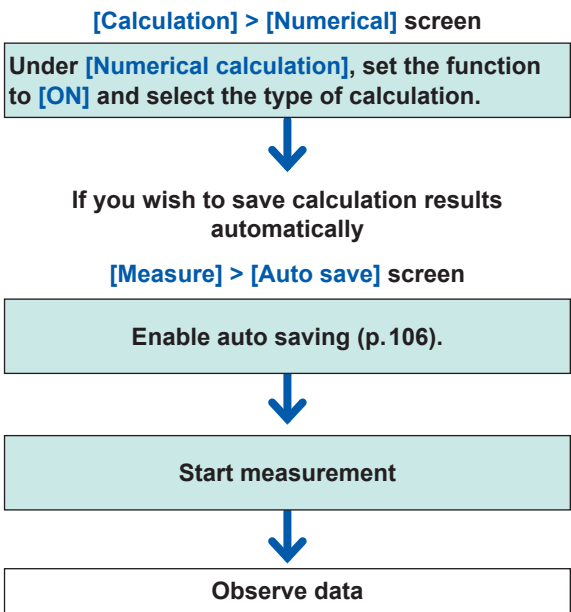

Performing calculations after measurement (Manual calculations)

Numerical calculation settings are configured, and calculations performed, after measurement.
 (p. 151)

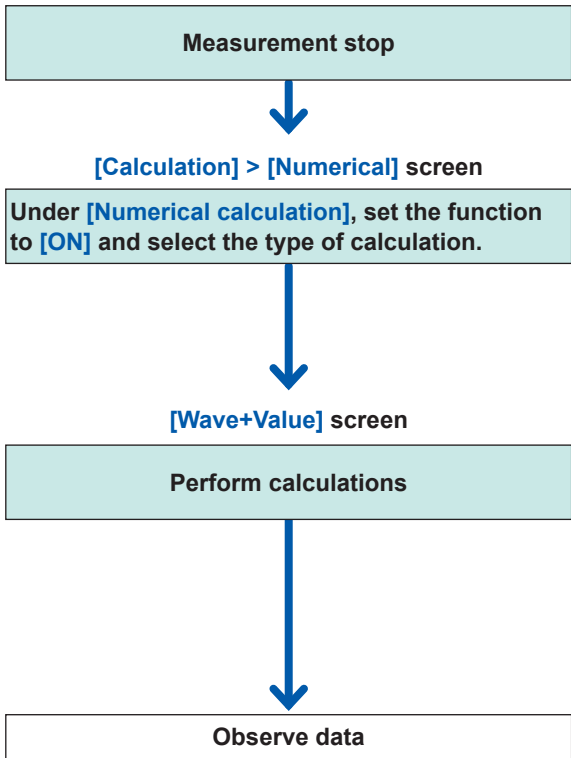

In the following instances, calculated values and saved data are treated as described in “11.13 Data Handling” (p. 302).

- When the waveform significantly exceeds the range's measurement scope (+OVER, -OVER)
- When the instrument detects a thermocouple wire break during temperature measurement (wire break detection)



Configuring numerical calculations

SET > Calculation > Numerical

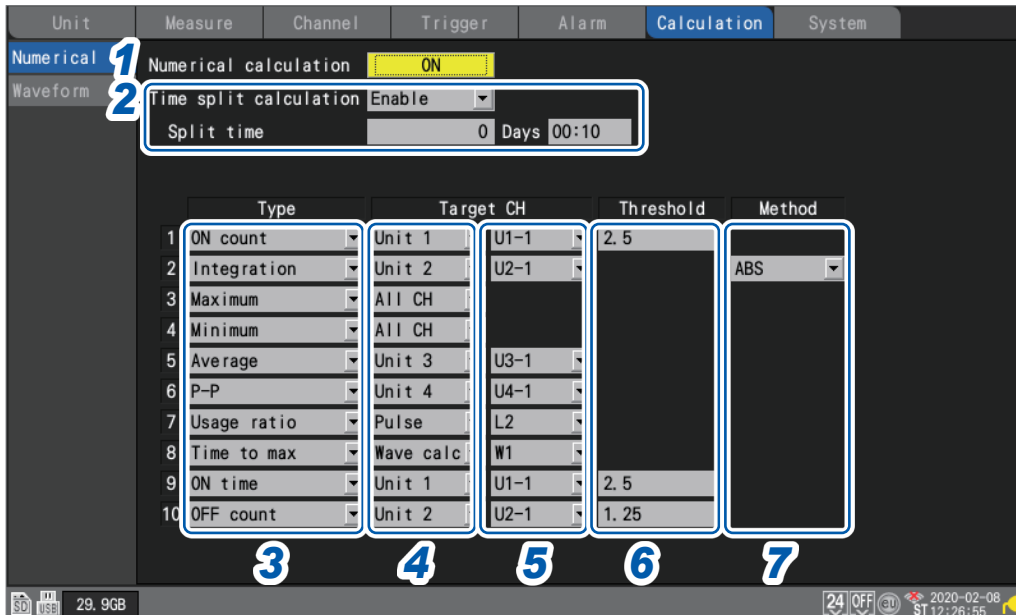

1 Under [Numerical calculation], set the numerical calculation function to [ON].

OFF , ON

2 Under [Time split calculation], select the file segmentation method.

Disable <input checked="" type="checkbox"/>	Saves the last numerical calculation results.
Enable	Allows you to set the interval at which to perform the calculation under [Split time]. The calculation will be performed after a start trigger, and the results saved, at the set interval.

For example, if the segment time is set to 10 min., the calculation will be performed, and the calculation results saved, every 10 min.

(When [Time split calculation] is set to [Enable])

Under [Split time], set the time interval at which to perform the calculation.

0 Days 00:01 to 30 Days 23:59

If [Time split calculation] is set to [Enable], calculation results will be saved for each time interval.

Under [Split time], set the time interval at which to perform the calculation. Calculation results will be saved for the specified amount of time. The value 0 d 0 hr. 0 min. cannot be specified as the segment time. The value will be automatically changed to 0 d 0 hr. 1 min.

If the format for numerical calculation results in the auto save settings has been set to [OFF], the [Time split calculation] setting will not be available.

See “Auto save (real-time save)” (p.106).

Set the format for numerical calculation results to [Text].

SET Unit Measure Channel Trigger Alarm Calculation System

3 Under [Type], select the type of numerical calculation.

You can set up to 10 numerical calculations at the same time.

Average	Calculates the average value.
P-P	Calculates the difference between the minimum and maximum values (the peak-to-peak value).
Maximum	Calculates the maximum value.
Minimum	Calculates the minimum value.
Time to max	Calculates the time from the start of recording until the maximum value.*
Time to min	Calculates the time from the start of recording until the minimum value.*
Aggregation	Calculates the integrated value.
Integration	Calculates the integral value.
Usage ratio	Calculates the rate at which the measured value is greater than the threshold value.
ON time	Calculates the total time for which the measured value is greater than the threshold value.
OFF time	Calculates the total time for which the measured value is less than the threshold value.
ON count	Calculates the number of times the measured value crosses the threshold value in the rising direction.
OFF count	Calculates the number of times the measured value crosses the threshold value in the falling direction.

*: Calculates the time from the trigger point when the trigger is used.

Only one threshold value can be set for each channel. If you specify the same channel for the ON and OFF time, the same threshold value will be used.

4 Under [Target CH], select the channel for which to perform the numerical calculation.

All CH <input checked="" type="checkbox"/>	Performs the numerical calculation using waveforms for all channels. Set the threshold value on the channel screen.
Unit n	Performs the numerical calculation using the waveform for the specified channel only. (n = 1, 2, ...)
Pulse	Performs the numerical calculation for a pulse waveform. (P1 to P8)
Wave calc	Performs the numerical calculation using a waveform generated by a waveform calculation. (W1 to W30)

5 (When [Target CH] is set to a value other than [All CH])

Set the individual channel for which the calculation is to be performed.

6 (When [Type] is set to [Usage ratio], [ON time], [OFF time], [ON count], or [OFF count])

Under [Threshold], set the reference value.

See "Value entry method" (p. 7).

7 (When [Type] is set to [Aggregation] or [Integration])

Select the calculation method.

For information about the calculation methods, see “Numerical calculation formulas” (p.153).

Total <input type="checkbox"/>	Calculates the difference between the integration or area enclosed by the zero position and the part of the signal waveform where its amplitude is positive and the integration or area enclosed by the zero position and the part of the signal waveform where its amplitude is negative.
Positive	Calculates the integration or area enclosed by the zero position and the part of the signal waveform where its amplitude is positive.
Negative	Calculates the integration or area enclosed by the zero position and the part of the signal waveform where its amplitude is negative.
ABS	Calculates the integration or area enclosed by the zero position and the signal waveform.

SET > Measure > Auto save

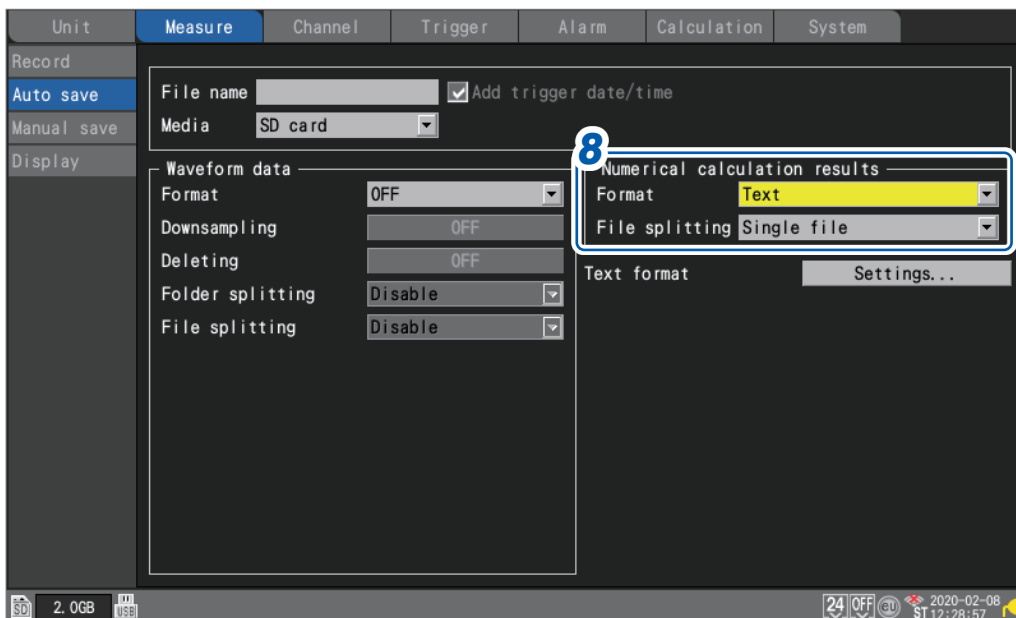

8 (When saving the numerical calculation results)

Auto saving: Configure the settings in the [Numerical calculation results] area. (See p.109.)

Manual saving: Under [Type], select [Calc results]. (See p.113.)

Real-time numerical calculations (automatic calculations)

This section describes how to perform numerical calculations while measurement is in progress. It also describes how to review calculation results at a given point in time on the **[Wave+Value]** screen during measurement.

- 1** **Configure the numerical calculation.**
See “Configuring numerical calculations” (p. 147).
- 2** **Press the **START** key to start measurement.**
Numerical calculations will be performed in real time.
- 3** **Press the **WAVE** key to display the **[Wave+Value]** screen.**

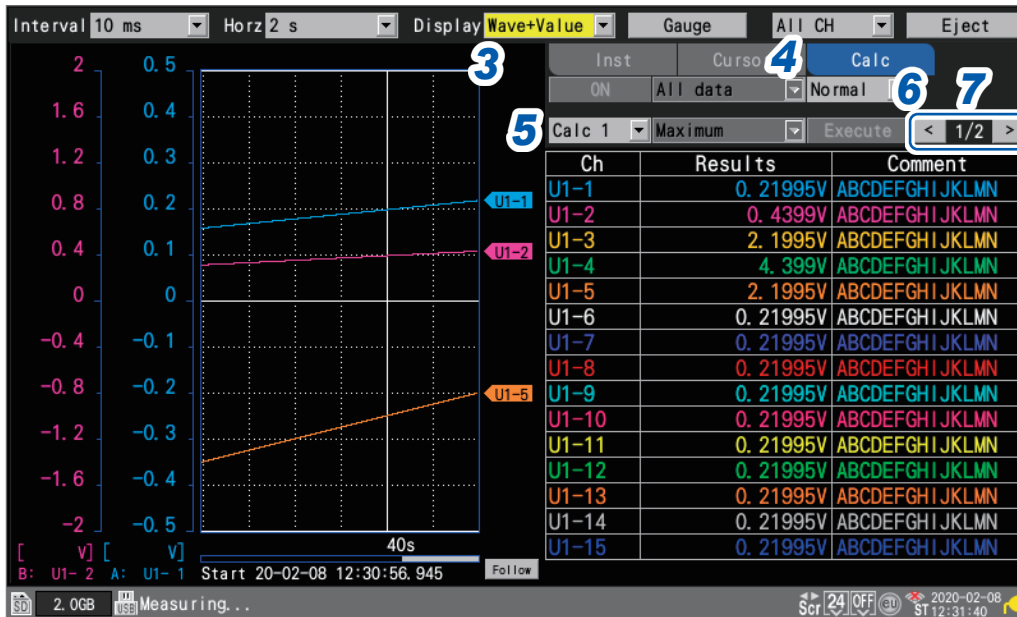

- 4** **Set the numerical display on the right side of the screen to **[Calc]**.**
The numerical calculation results will be displayed, allowing you to review the calculation results at any given point in time.
- 5** **Select a numerical calculation of which you wish to display the result.**
You can select a numerical calculation of which you wish to display the result from among **[Calc 1]** through **[Calc 10]**.
- 6** **(When **[Time split calculation]** is set to **[Enable]**) Select a numerical calculation of which you wish to display the result.**

Normal <input checked="" type="checkbox"/>	Displays the values calculated using data from the start of measurement.
Split <input type="checkbox"/>	Displays the calculated values updated at regular intervals.

When **[Split]** have been selected, the first segmented time (can be changed to the date or number of data points under **[Display horizontal axis]**) will be displayed underneath the calculation results table.

- 7** **Switch the channel using the **[<]** and **[>]** keys (as necessary).**
You can change the channel for which to display calculation results.

Numerical calculations after measurement (manual calculations)

This section describes how to use the instrument's control keys to perform numerical calculations after measurement.

You can review calculation results by displaying the [Wave+Value] screen and then setting the numerical display on the right side of the screen to [Calc].

- 1 Press the **START** key to start measurement.
- 2 Once measurement completes, configure the numerical calculation.
See "Configuring numerical calculations" (p. 147).
- 3 Press the **WAVE** key to display the [Wave+Value] screen.

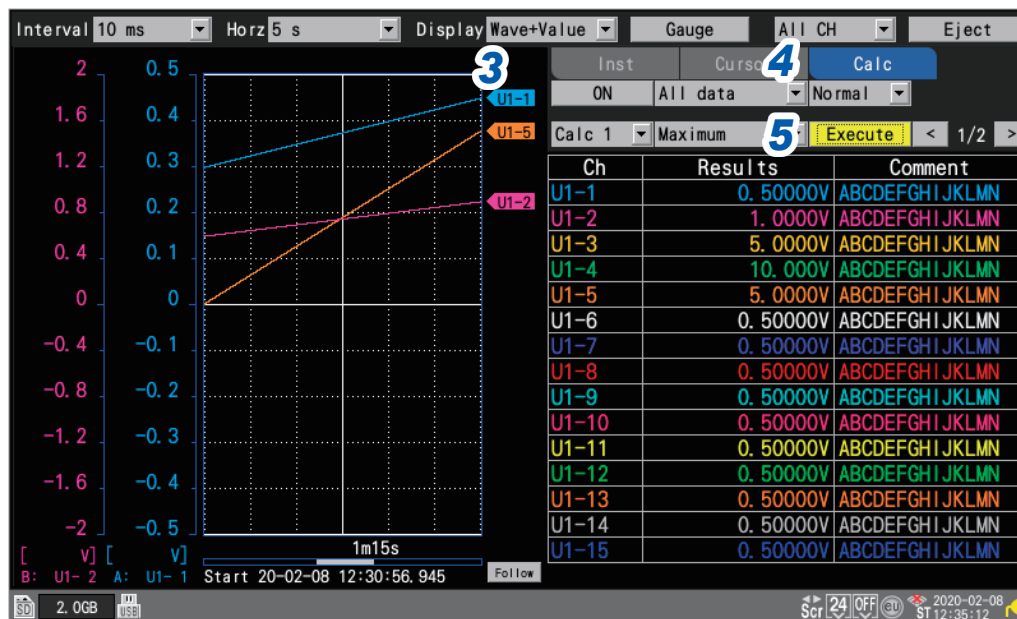

- 4 Set the numerical display on the right side of the screen to [Calc].
The numerical calculation's settings will be displayed.
- 5 Press the **ENTER** key while [Execute] is selected.
The numerical calculation set in step 2 will be performed.

Numerical calculations can also be performed using waveforms that have been loaded from media (an SD Memory Card or USB Drive). Once the waveform has been loaded, proceed to step 2 above.

Time segmentation calculation cannot be performed manually.

Partial numerical calculations

If performing manual calculations, you can specify the range over which to perform the calculation. The numerical calculation will be performed after the range has been specified with the A/B cursors (vertical).

1 Specify the range with the A/B cursors.

For information about how to specify the range, see “Specifying a waveform range” (p.77)

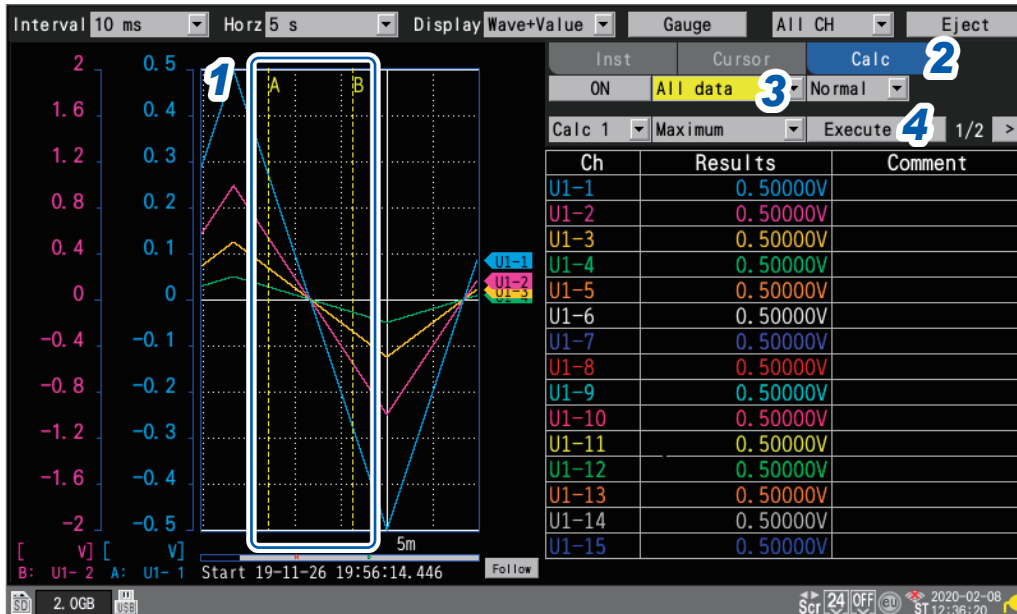

2 Set the numerical display on the right side of the screen to [Calc].

The numerical calculation's settings will be displayed.

3 Select the range over which to perform the calculation.

All <input checked="" type="checkbox"/>	Performs the calculation using the waveforms for the entire recorded length, without regard to the A/B cursors.
A-B	Performs the calculation using the waveforms between the A and B cursors.
Start-A	Performs the calculation using the waveforms from the beginning to the A cursor.
Start-B	Performs the calculation using the waveforms from the beginning to the B cursor.
A-End	Performs the calculation using the waveforms from the A cursor to the end.
B-End	Performs the calculation using the waveforms from the B cursor to the end..

4 Press the ENTER key while [Execute] is selected.

The numerical calculation will be performed over the range specified in step 3.

Numerical calculation formulas

The following table provides a detailed description of each numerical calculation.

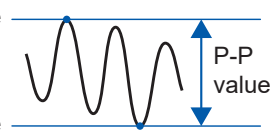
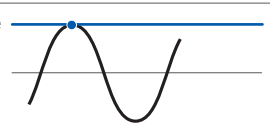
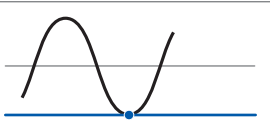
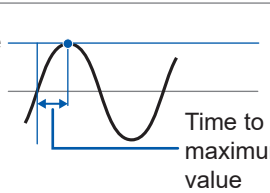
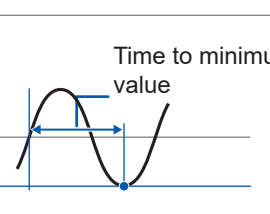
Calculation type	Description	
Average	Calculates the average value of the waveform data. $AVE = \frac{1}{n} \sum_{i=1}^n di$ <i>AVE</i> : Average value <i>n</i> : Number of data points <i>di</i> : <i>i</i> th data point for channel	
P-P	Calculates the value between the maximum value and the minimum value (peak-to-peak value).	Maximum value  Minimum value
Maximum	Calculates the maximum value of the waveform data.	Maximum value 
Minimum	Calculates the minimum value of the waveform data.	Minimum value 
Time to max	Calculates how long (s) it took for the waveform to reach the maximum value from the start of recording.* If the maximum value occurs at 2 or more points, the first time the waveform targeted by the calculation reaches the maximum value is used to determine this value.	Maximum value 
Time to min	Calculates how long (s) it took for the waveform to reach the minimum value from the start of recording.* If the minimum value occurs at 2 or more points, the first time the waveform targeted by the calculation reaches the minimum value is used to determine this value.	Minimum value 
Aggregation (Total)	Calculates the integrated value for the measurement data. $SUM = \sum_{i=1}^n di$ <i>SUM</i> : Integrated value <i>n</i> : Total number of data points <i>di</i> : <i>i</i> th data point for channel	
Aggregation (Positive)	Calculates the integrated value for positive measurement data. $SUM = \sum_{i=1, di > 0}^n di$ <i>SUM</i> : Integrated value <i>n</i> : Total number of data points <i>di</i> : <i>i</i> th data point for channel	
Aggregation (Negative)	Calculates the integrated value for negative measurement data. $SUM = \sum_{i=1, di < 0}^n di$ <i>SUM</i> : Integrated value <i>n</i> : Total number of data points <i>di</i> : <i>i</i> th data point for channel	
Aggregation (ABS)	Calculates the integrated value for the absolute value of measurement data. $SUM = \sum_{i=1}^n di $ <i>SUM</i> : Integrated value <i>n</i> : Total number of data points <i>di</i> : <i>i</i> th data point for channel	

*: Calculates the time from the trigger point when the trigger is used.

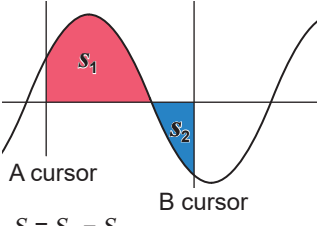
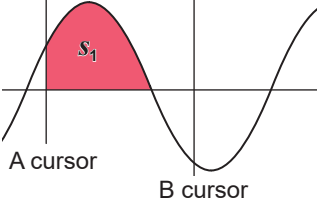
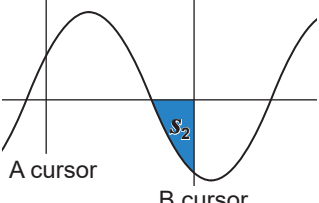
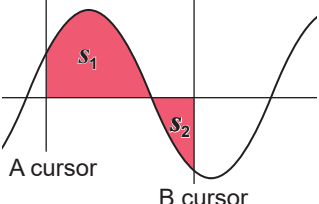
Calculation type	Description	
<p>Integration (Total)</p>	<p>Calculates the difference between the area (V·s) enclosed by the zero position (0 V position) and the part of the signal waveform where its amplitude is positive and the area (V·s) enclosed by the zero position (0 V position) and the part of the signal waveform where its amplitude is negative.</p> <p>Calculates the integration between the cursors when performing the calculation over a specific range (selected using the A/B cursors).</p> $S = \sum_{i=1}^n di \times \Delta t$ <p> <i>S</i>: Integral value <i>n</i>: Total number of data points <i>di</i>: <i>i</i>th data point for channel Δt: Sampling period </p>	 <p>A cursor B cursor</p> $S = S_1 - S_2$
<p>Integration (Positive)</p>	<p>Calculates the area (V·s) enclosed by the zero position (0 V position) and the area where the signal waveform's amplitude is positive.</p> <p>When performing the calculation over a specific range (selected using the A/B cursors), calculates the integration between the cursors.</p> $S = \sum_{i=1, di > 0}^n di \times \Delta t$ <p> <i>S</i>: Integral value <i>n</i>: Total number of data points <i>di</i>: <i>i</i>th data point for channel Δt: Sampling period </p>	 <p>A cursor B cursor</p> $S = S_1$
<p>Integration (Negative)</p>	<p>Calculates the area (V·s) enclosed by the zero position (0 V position) and the area where the signal waveform's amplitude is negative.</p> <p>When performing the calculation over a specific range (selected using the A/B cursors), calculates the integration between the cursors.</p> $S = \sum_{i=1, di < 0}^n di \times \Delta t$ <p> <i>S</i>: Integral value <i>n</i>: Total number of data points <i>di</i>: <i>i</i>th data point for channel Δt: Sampling period </p>	 <p>A cursor B cursor</p> $S = -S_2$
<p>Integration (ABS)</p>	<p>Calculates the area (V·s) enclosed by the zero position (0 V position) and the signal waveform.</p> <p>When performing the calculation over a specific range (selected using the A/B cursors), calculates the integration between the cursors.</p> $S = \sum_{i=1}^n di \times \Delta t$ <p> <i>S</i>: Integral value <i>n</i>: Total number of data points <i>di</i>: <i>i</i>th data point for channel Δt: Sampling period </p>	 <p>A cursor B cursor</p> $S = S_1 + S_2$

6.2 Performing Waveform Calculations

This section describes how to perform basic arithmetic operations between channels and how to calculate values such as a moving average. (Up to 30 calculations can be performed.)

The following types of calculations are available: basic arithmetic operations, integration, simple average, moving average, and integral.

Calculations are performed in real time while measurement continues, and post-calculation waveforms are displayed.

Waveform calculations cannot be performed after measurement.

Waveform calculation results are displayed in the calculation channels (**[W1]** to **[W30]**).

SET > Calculation > Waveform



1 Select the item to display.

Formula , Display, Comment, Numerical calc

Calculation list screen: [Display]

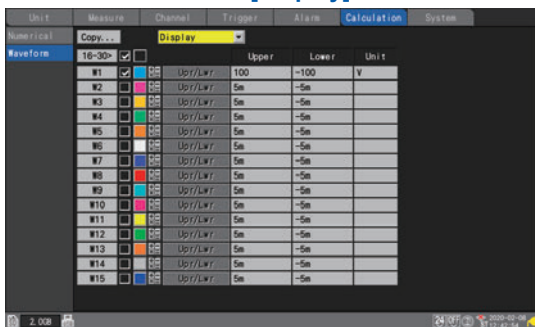

Calculation list screen: [Comment]

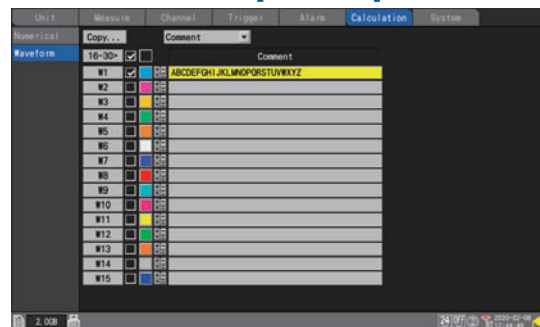

Calculation list screen: [Numerical calc]

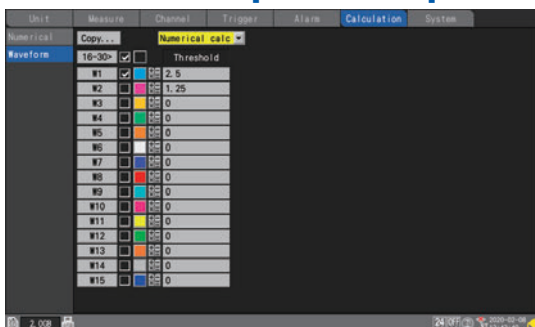

SET Unit Measure Channel Trigger Alarm Calculation System

2 You can cycle through the calculation channel to display.

- Press the **ENTER** key while **[16-30>]** is selected to display W16 to W30.
- Press the **ENTER** key while **[1-15>]** is selected to display W1 to W15.

3 Select the checkboxes for the channels for which you wish to perform calculations.

4 Select the waveform display color.

× (OFF), 24 colors

Select **[×]** if you wish to perform the waveform calculation but not to display the waveform on the screen.

5 Select a calculation channel and press the **ENTER** key.

The individual settings window will open.

You can specify the calculation channel, toggle waveform calculation on and off, and set the waveform display color.

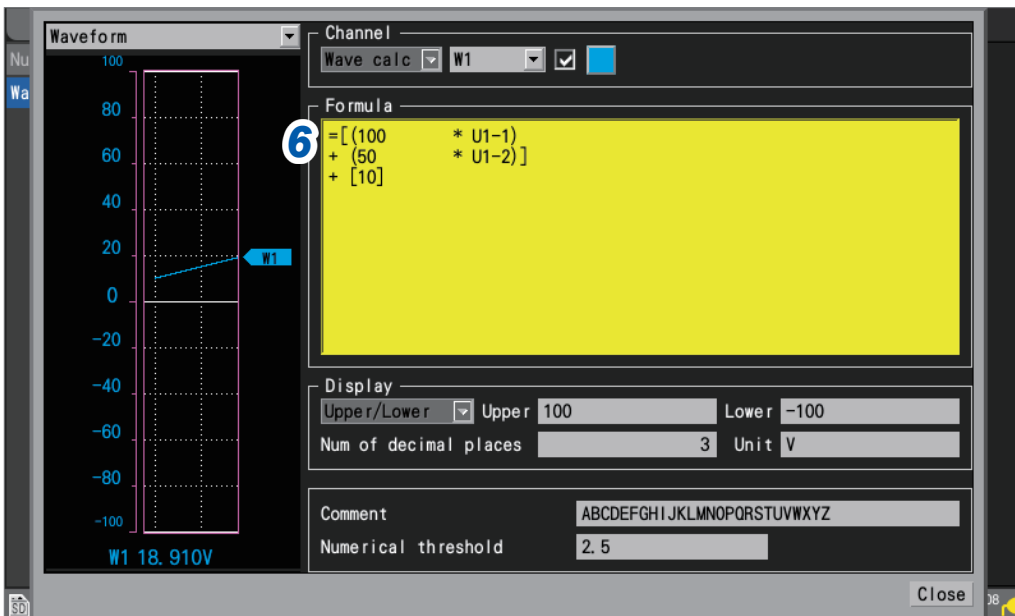

6 Press the **ENTER** key while **[Formula]** is selected.

The waveform calculation entry window will open.

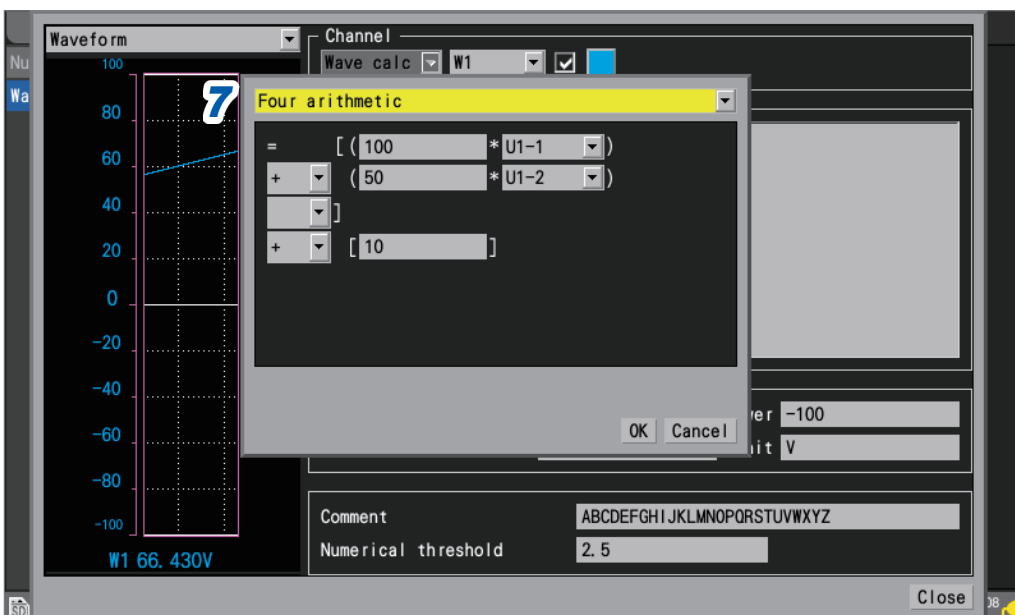

7 Set the type of the waveform calculation.

Four arithmetic <input checked="" type="checkbox"/>	Performs between channels addition, subtraction, multiplication, and division. This setting allows you to enter channels, coefficients, and constants. (You can also set exponents as constants.)
Aggregation	Adds the measurement data and plot its sum total. Set the channel, [Reset start time] , and [Reset time] .
Simple average	Adds and average all measurement data from the start of measurement and plots the results. Set the channel, [Reset start time] , and [Reset time] .
Moving average	Calculates the average using the specified number of points while moving. Perform averaging processing using the specified number of points for each sampled data point and plots the results. Set the channel, and [Number of points] .
Integration	Adds values obtained by multiplying measurement data by the sampling period and plot the sum total. Set the channel, [Reset start time] , and [Reset time] .

8 (When **[Four arithmetic]** is selected)

Specify constants, target channels, and operators.

Calculation expression

(A * CHa B * CHb C * CHc D * CHd) E

A, B, C, D, E: User-specified constants

CHa, CHb, CHc, CHd: User-specified measurement channels (up to 4 channels)

: Any one operation sign of plus (+), minus (-), multiplication (*), or division(/) or a blank character
If entering a blank character, you cannot enter any further terms in the parentheses

: Any one operation sign of plus (+), minus (-), multiplication (*), division(/), or exponentiation (^) or a blank character

If entering a blank character, you cannot enter a constant.

Example: To write an expression (A*CH1)², enter (A*CH1)^2.

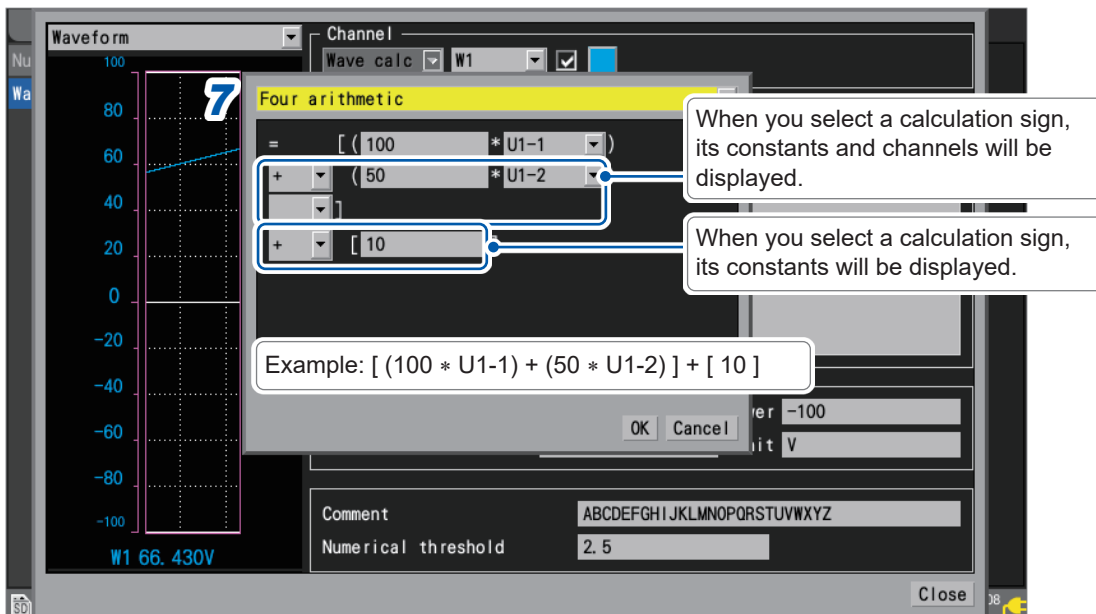

You can select a calculation channel as a target channel; however, you cannot select a calculation channel with a number that is larger than the number of the configured calculation channel. Example: You can set **[W1]** through **[W4]** as the calculation channel for **[W5]**.

- 9** (When [Type] is set to [Aggregation], [Simple average], or [Integration])
Under [Reset start time], select the reset operation to perform when measurement starts.

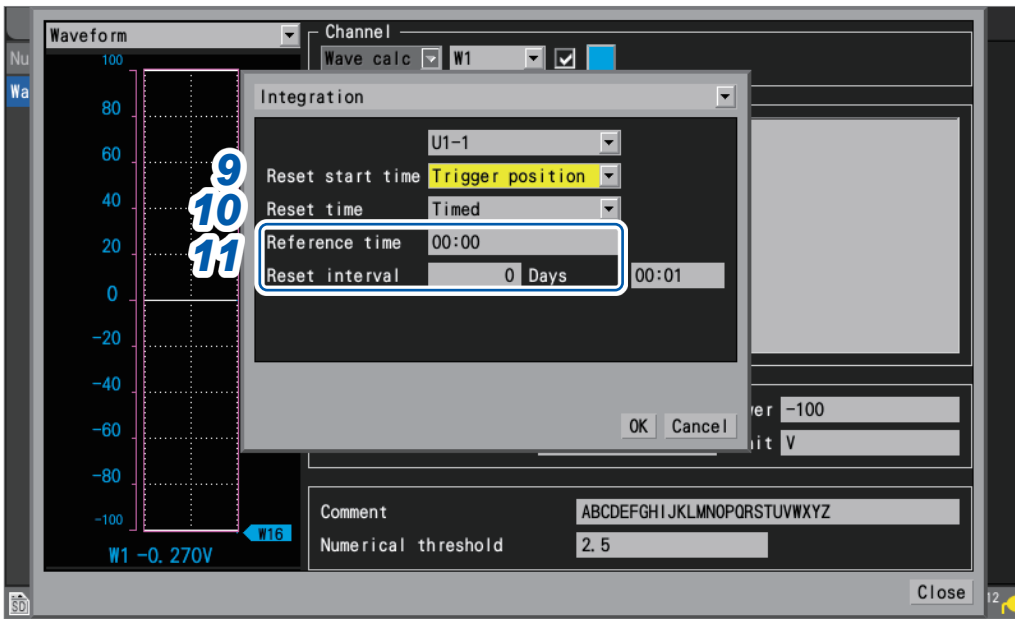

OFF <input checked="" type="checkbox"/>	Does not reset calculation results.
Trigger position	Resets calculation results when a trigger activates.

- 10** (When [Type] is set to [Aggregation], [Simple average], or [Integration])
Under [Reset time], select when to perform reset operation.

Disable <input checked="" type="checkbox"/>	Does not reset calculation results.
Enable	Resets calculation results at the set time intervals.
Timed	Resets calculation results at the set intervals starting at the specified time.

- 11** (When [Reset time] is set to [Enable])
Set the [Reset interval].

(When [Reset time] is set to [Timed])
Set the [Reference time] and [Reset interval].

12 Configure display settings.

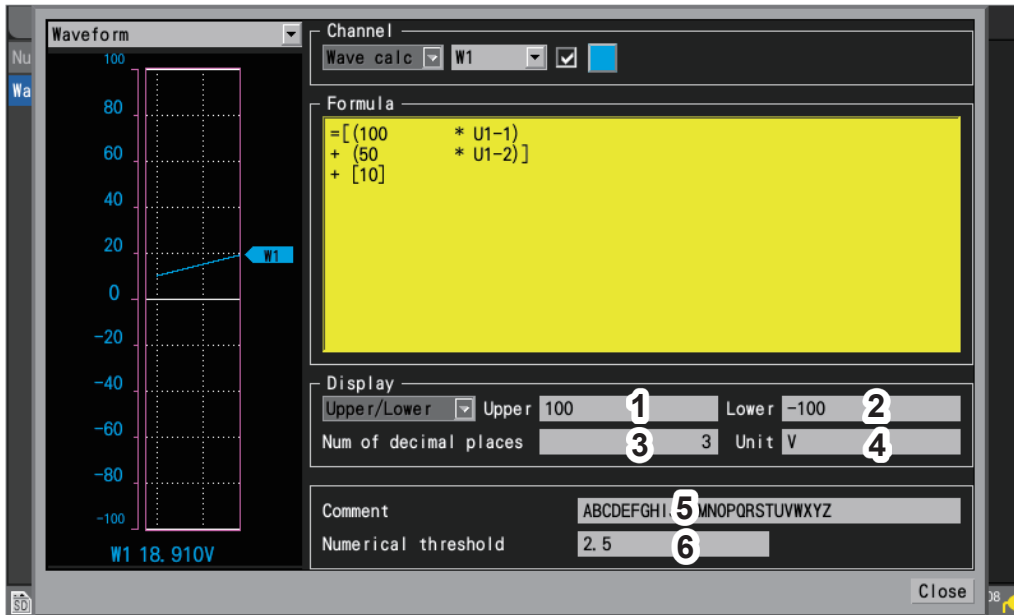

1	Upper	Upper limit value when displaying waveform calculation results on the screen
2	Lower	Lower limit value when displaying waveform calculation results on the screen
3	Num of decimal places	Number of decimal places for measured values This setting is not displayed when [Number display format] is set to [Standard] .
4	Unit	Unit for waveform calculation results
5	Comment	Comment for each calculation channel
6	Numerical threshold	Threshold value for numerical calculations (Availability, ON time, OFF time, ON count, OFF count)

Tips Threshold values are used for numerical calculations. For more information, see “Configuring numerical calculations” (p.147).

Configuring calculations on the calculation list screen

This section describes how to review waveform calculation settings on the calculation list screen. It also describes how to configure settings on the screen.

SET > **Calculation** > **Waveform**

Calculation list screen: **[Formula]**

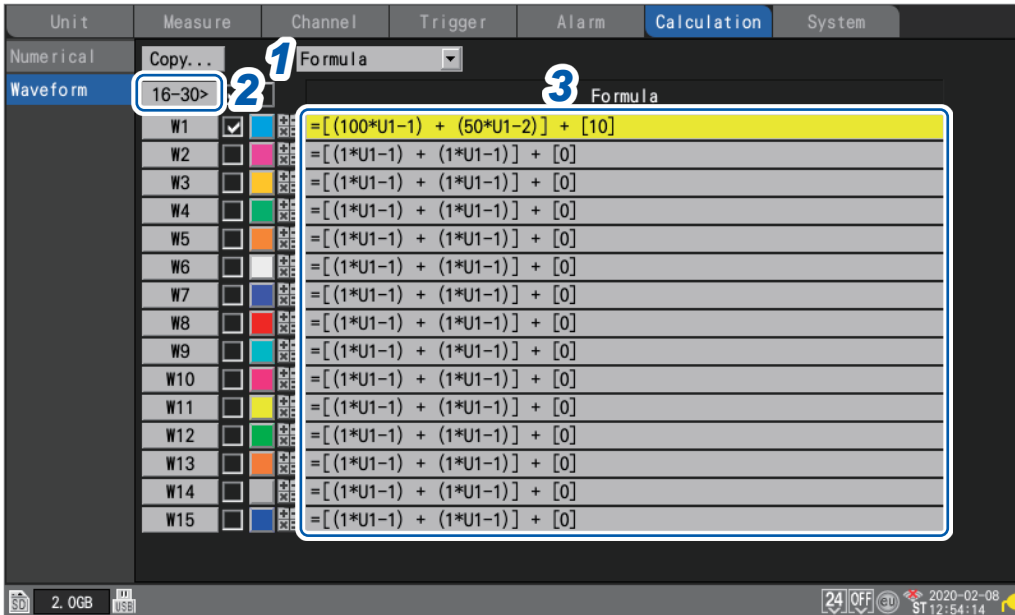

1 Set the display to **[Formula]**.

Formula , Display, Comment, Numerical calc

2 You can cycle through the calculation channel to display.

- Press the **ENTER** key while **[16-30>]** is selected to display W16 to W30.
- Press the **ENTER** key while **[1-15>]** is selected to display W1 to W15.

3 Press the **ENTER** key while **[Formula]** is selected.

The waveform calculation entry window will open.

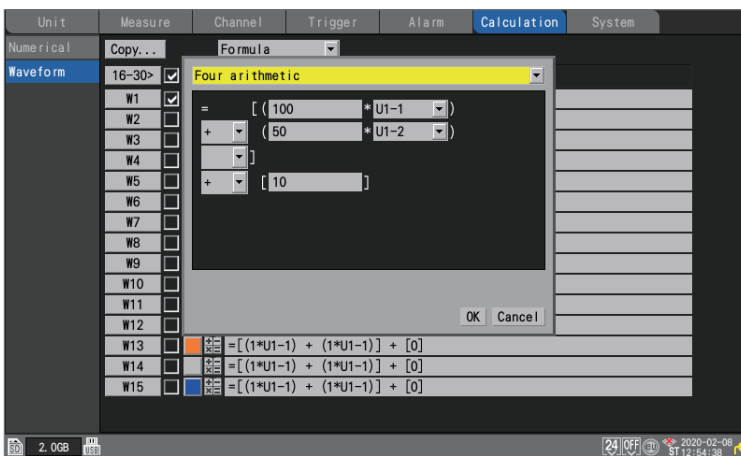

Continue with the procedure described in p. 157.

Copying calculation formulas

This section describes how to copy the calculation for calculation channel **[W1]** to the other calculation channels (**[W2]** to **[W30]**).

SET > **Calculation** > **Waveform**

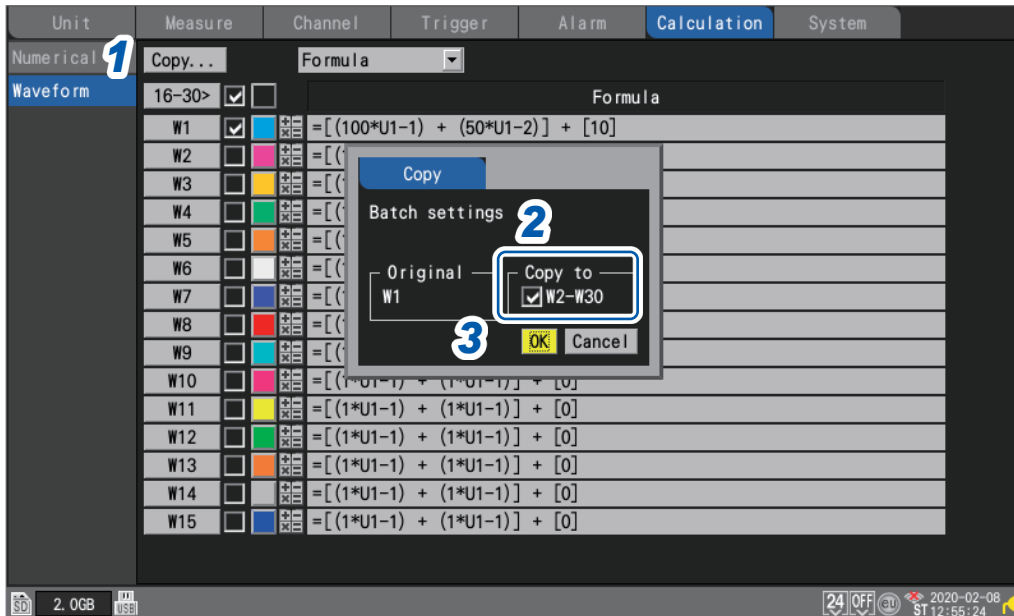

- 1** Press the **ENTER** key while **[Copy...]** is selected.
The settings window will open.
- 2** Select the checkbox for the **[Copy to]**.
The source cannot be changed from **[W1]**.
- 3** Press the **ENTER** key while **[OK]** is selected.
The **[W1]** settings will be copied to **[W2]** to **[W30]**.
Press the **ENTER** key while **[Cancel]** is selected to cancel the copy operation.

Configuring waveform calculation settings at once

This section describes how to configure the waveform calculation on or off and waveform display color settings for all waveform calculations.

SET > **Calculation** > **Waveform**



- 1** Select the waveform calculation ON/OFF checkbox and press the **ENTER** key.
Each time you press the **ENTER** key, all calculation channels will toggle between ON and OFF.
- 2** Select the measurement display color checkbox and press the **ENTER** key.
Each time you press the **ENTER** key, the display setting for all calculation channels will toggle between ON and OFF.

7 Configuring System Settings



The system screen provides the functionality described below.

- 7.1 Configuring Settingsp. 164**
- 7.2 Controlling the Systemp. 167**
 - Setting the time p. 167
 - Synchronizing the time p. 168
 - Initializing (resetting) the system p. 169
 - System configuration..... p. 170
 - Performing a self-check..... p. 171

7.1 Configuring Settings

This section describes how to configure various system functions.

SET > System > Environment

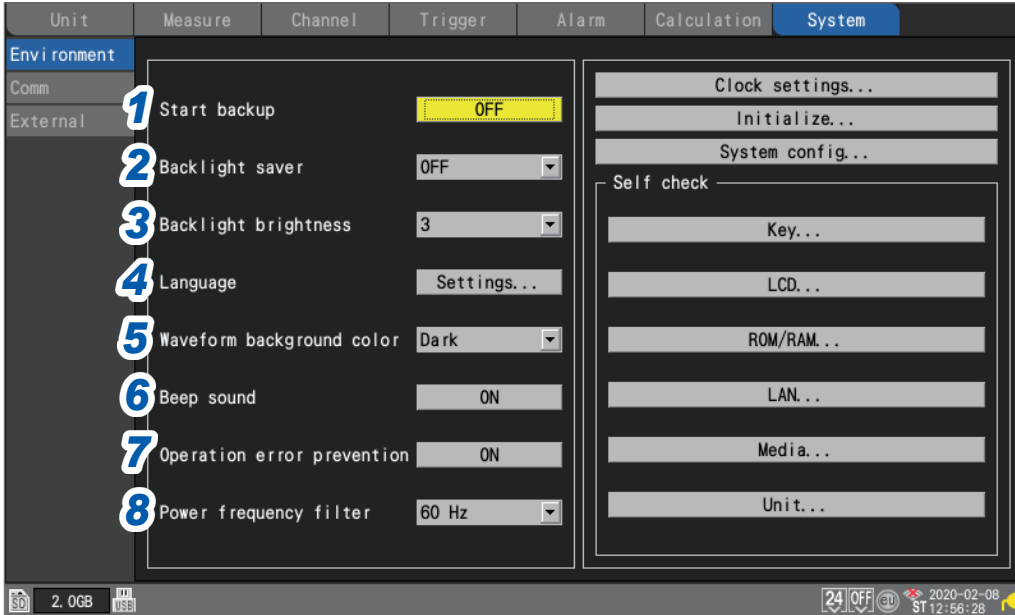

1 Under [Start backup], select the operation to perform when the instrument is turned back on (start back up).

When set to **[ON]**, the instrument will automatically resume recording when the power comes back on after being interrupted during measurement, for example due to a power outage.

OFF <input checked="" type="checkbox"/>	Does not use the start state retention function.
ON	Uses the start state retention function.

If triggers are being used, the instrument will enter the trigger wait state. If measurement is resumed while in the start retention state, data that was stored in the instrument's internal buffer memory before the power outage will be deleted.

2 Under [Backlight saver], select how long to wait after the last key operation until turning off the LCD backlight.

OFF <input checked="" type="checkbox"/>	Disables the backlight saver (leave the backlight on all the time).
30 s, 1 min, 2 min, 5 min, 10 min	Turns off the backlight when no key has been operated for the set amount of time.

You can extend the backlight's service life by choosing a setting other than **[OFF]**. Those settings also reduce power consumption. Press any key to turn the backlight on.

Tips

- The instrument consumes power even when the backlight is off. It is recommended to turn off the instrument when it is not in use.
- If the screen is not displayed while the instrument is powered on, the backlight saver may be enabled.



3 Under **[Backlight brightness]**, select the backlight brightness.

1, 2, 3 , 4, 5

Larger values indicate higher brightness levels.

Lowering the backlight brightness (dimming the backlight) will allow the instrument to operate longer on battery power.

4 Under **[Language]**, select the user interface language.

Press the **ENTER** key to display a settings window. Configure screen display and keyboard settings.

Select **[OK]** after selecting the language to close the window. Select **[Cancel]** to close the window without changing any settings.

日本語 (Japanese), **English**, 简体中文 (Simplified Chinese)*, 한국어 (Korean)*

*: Available soon.

5 Under **[Waveform background color]**, select the background color for the waveform screen.

Dark , Light

Dark

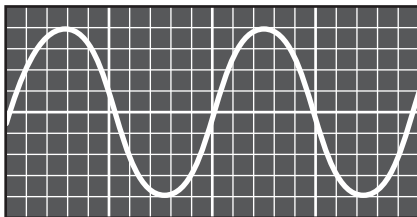

Light

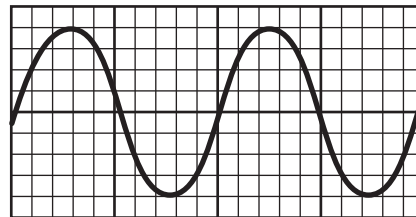

6 Under **[Beep sound]**, select whether to beep when a warning or error occurs.

ON , OFF

7 Under **[Operation error prevention]**, select whether to display a confirmation window when starting and stopping measurement.

ON <input checked="" type="checkbox"/>	Displays a confirmation window when the START key or STOP key is pressed. Press the ENTER key while [Yes] is selected to start or stop measurement.
OFF	Starts measurement immediately when the START key is pressed. Stops measurement immediately when the STOP key is pressed.

When measurement starts, data in the instrument's internal buffer memory will be deleted, and the instrument will start to record new data.

Select the **[ON]** setting to prevent waveform data from being inadvertently deleted.

8 Under **[Power frequency filter]**, select the power supply frequency in the region where the instrument is being used.

60 Hz <input checked="" type="checkbox"/>	Uses the digital filter for 60 Hz regions.
50 Hz	Uses the digital filter for 50 Hz regions.



It is recommended to select the same frequency (50 Hz or 60 Hz) as the power supply frequency in the region where the instrument is being used.

When using the U8550 to U8553 modules, power supply noise can be rejected by using the data refresh interval setting.

See "Measurement module data refresh intervals" (p.13).

Configure the low pass filter for Strain Units (U8554, LR8534) since the power supply frequency filter function is not available for those modules.

See "Measuring strain" (p.27).

7.2 Controlling the System

This section describes how to set the time and initialize (reset) the instrument. It also describes how to perform a self-check.

Setting the time

The instrument has a calendar with automatic leap year detection as well as a 24-hour clock. The clock is displayed in YYYY-MM-DD HH:MM:SS format at the bottom right of the screen. Set the time if the displayed time diverges from the actual time.

The time is used when starting measurement (start trigger time) and in file information.

SET > System > Environment

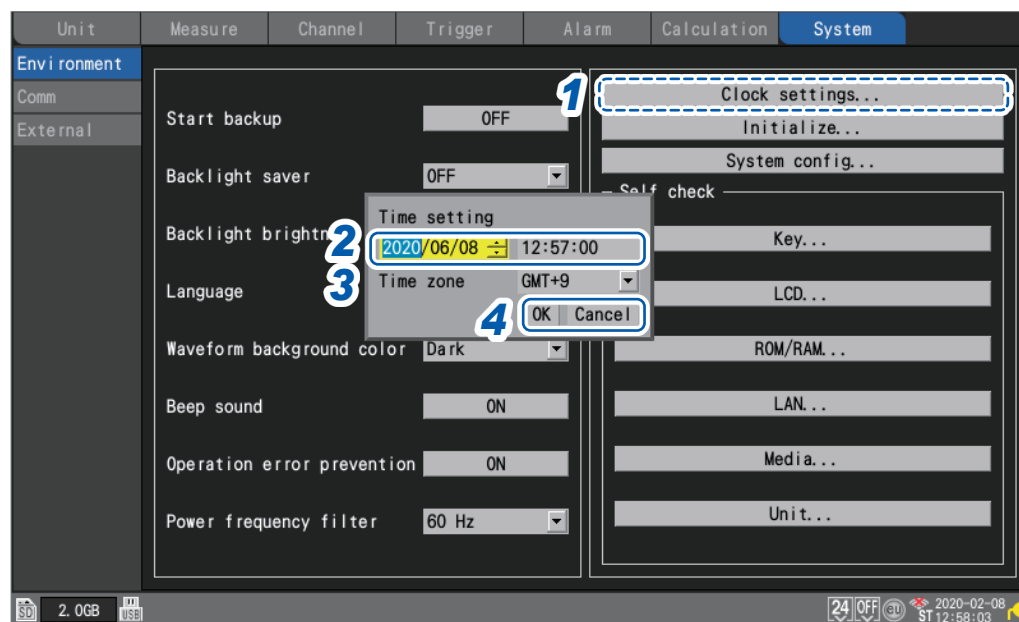

- 1** Press the **ENTER** key while **[Clock settings...]** is selected.
The settings window will open.
- 2** Configure the year, month, day, hour, minute, and second settings.
See "Value entry method" (p.7).
- 3** Select **[Time zone]**, and then press the **ENTER** key.
Default setting: **[GMT+9]**
- 4** Press the **ENTER** key while **[OK]** is selected.
The time will be updated to reflect the new settings.
Press the **ENTER** key while **[Cancel]** is selected to close the window without changing the time.

Synchronizing the time

This section describes how to synchronize the instrument's time with an NTP server. The LAN settings must be configured in advance. See "9.3 Configuring and Establishing a LAN Connection" (p. 189).

SET > **System** > **Comm**

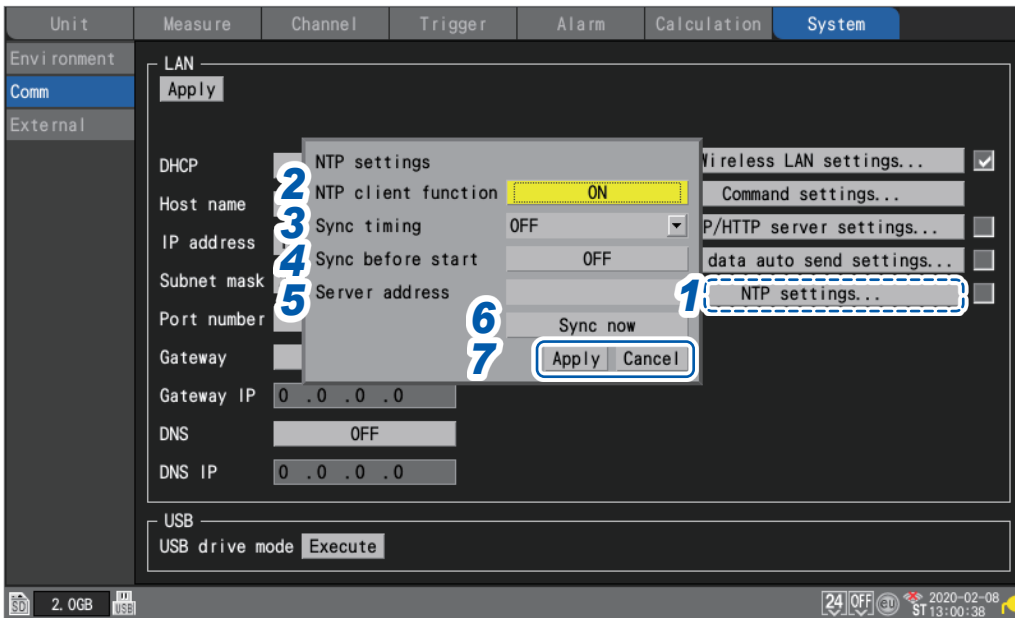

1 Press the **ENTER** key while **[NTP settings...]** is selected.

The settings window will open.

2 Set the **[NTP client function]** to **[ON]**.

3 Under **[Sync timing]**, select when to connect to the NTP server and set the time.

OFF <input checked="" type="checkbox"/>	Does not set the time.
Every hour	Sets the time once an hour.
Every day	Sets the time once a day.

4 Under **[Sync before start]**, select whether to connect to the NTP server and set the time before starting measurement.

OFF <input checked="" type="checkbox"/> , ON
--

5 Under **[Server address]**, set the address of the NTP server.

6 Press the **ENTER** key while **[Sync now]** is selected.

Once the settings have been applied, the instrument will connect to the specified NTP server and set the time.

7 Press the **ENTER** key while **[Apply]** is selected.

The settings will be applied.

Press the **ENTER** key while **[Cancel]** is selected to close the window without changing any settings.

Initializing (resetting) the system

This section describes how to reset all settings to their factory defaults.

See "11.9 Settings after Initialization (System Reset)" (p.290).

SET > **System** > **Environment**

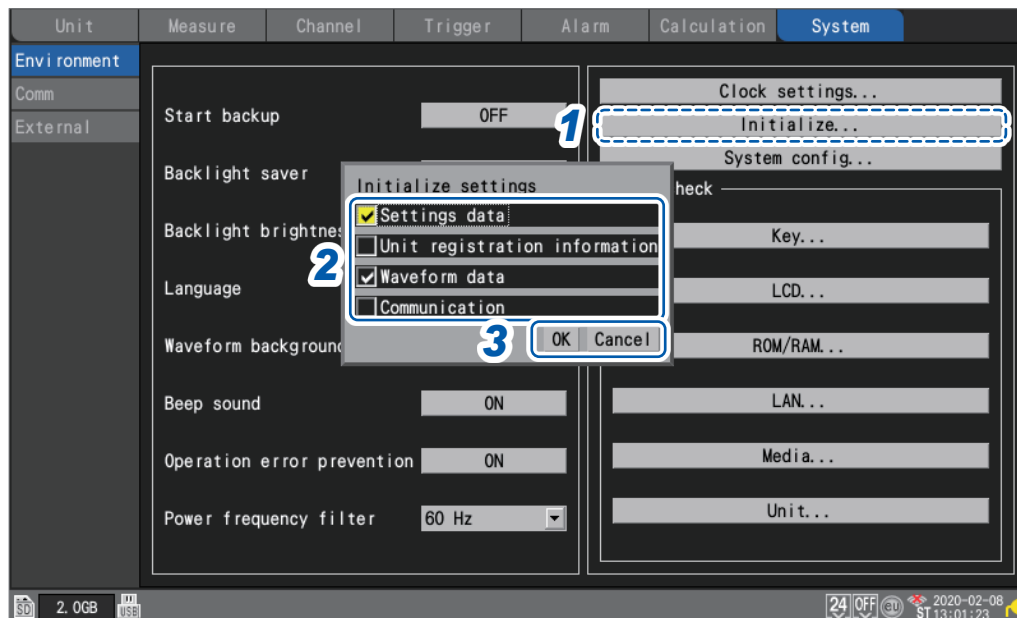

1 Press the **ENTER** key while **[Initialize...]** is selected.

The settings window will open.

2 Select the checkboxes for the settings you wish to initialize.

Settings data	Resets all non-LAN settings to their default values.
Unit registration information	Deletes information for all registered wireless modules.
Waveform data	Deletes waveform data.
Communication	Resets LAN settings to their default values.

3 Press the **ENTER** key while **[OK]** is selected.

The settings will be initialized.

Press the **ENTER** key while **[Cancel]** is selected to close the window without initializing any settings.



If you initialize module information and communications settings, you need to re-register all wireless modules and re-configure the LAN settings. Ordinarily, it is not recommended to initialize them.

System configuration

This section describes how to check the instrument's firmware version, installed modules, and other system configuration.

SET > **System** > **Environment**

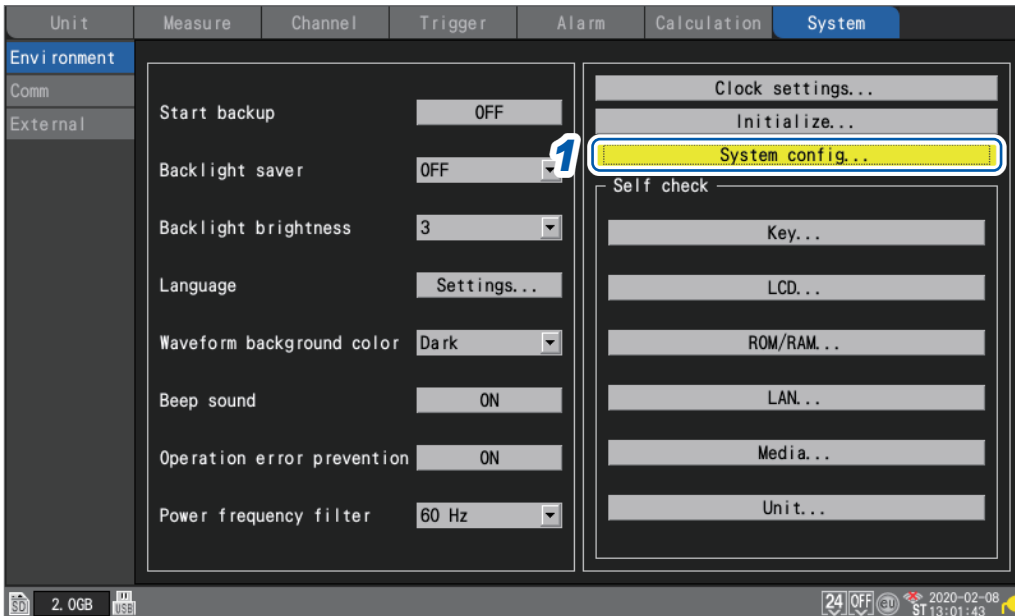

1 Press the **ENTER** key while **[System config...]** is selected.

A list of system configuration will open.

2 Select **[Main]** or **[Unit]** using the **Left Arrow** and **Right Arrow** keys.

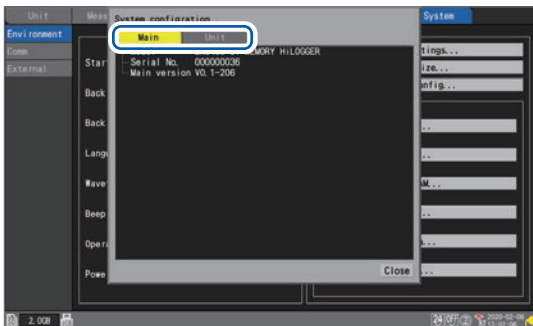

Main	Model	The instrument's model number (LR8450 or LR8450-01)
	Serial No.	The instrument's serial number
	Main version	The instrument's software version
Unit	Unit No.	Measurement module numbers (Unit 1 to 4: Plug-in modules; Remote 1 to 7: Wireless modules)
	Model	The measurement module's model number
	Name	The measurement module's model name
	Serial No.	The measurement module's serial number
	Version	The measurement module's software version
	Revision	The measurement module's circuit board revision

Performing a self-check

This section describes how to perform a self-check.

The results will be shown on the screen. Contact your authorized Hioki distributor or reseller in the event of an abnormal result.

SET > System > Environment

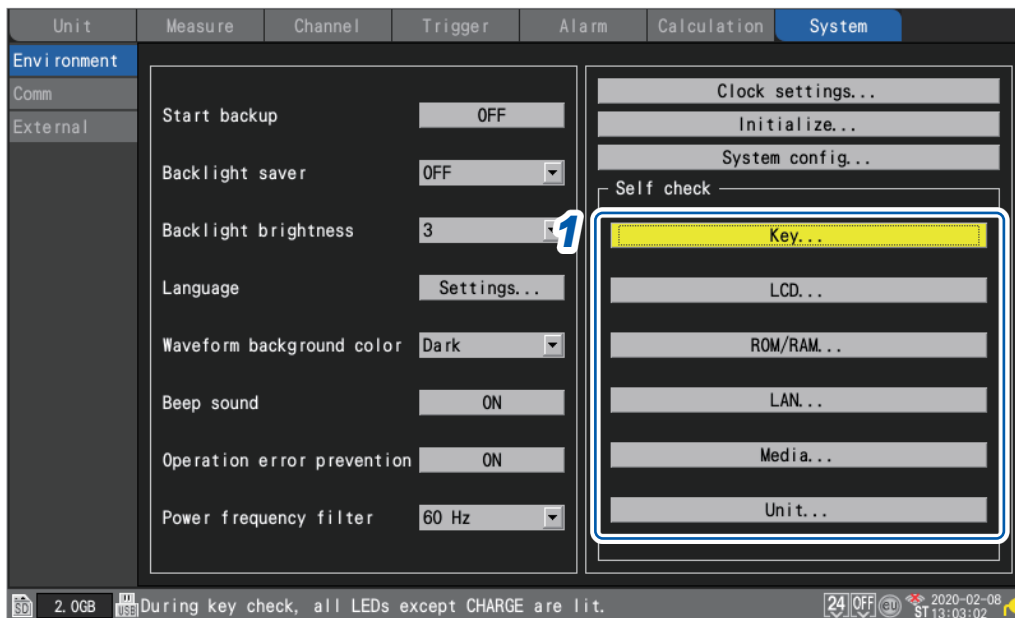

- 1 Select the type of diagnostics you wish to perform in the [Self check] area and press the **ENTER** key.

The self-check window will open.

- 2 Follow the instructions to perform the self-check.

Key...	Checks key recognition. Additionally, verifies that the LEDs are working properly. The self-check will end once all keys have been checked. You can force-quit the self-check in the event of a malfunction by pressing the ESC key twice.
LCD...	Checks the screen display. The screen will cycle through the following colors and then return to the original screen each time you press a key: White → black → red → green → blue → gradation
ROM/RAM...	Checks the instrument's built-in memory (ROM, RAM).
LAN..	Checks if the LAN interface operates properly. If a FAIL judgment exhibits, check cable connection and settings including the IP address and firewall. If such a condition cannot be corrected, please contact your authorized Hioki distributor or reseller to have the instrument repaired.
Media...	Checks if the SD Memory Card and USB Drive can be detected.
Unit....	Displays information about connected modules and checks their status.





This chapter describes how to control the instrument by inputting signals to its external control terminals.

Signals corresponding to the instrument's operation are output from the external control terminals.

You can configure settings related to the external control terminals on the **[System] > [External]** settings screen.

The external control terminals are not isolated (they use the same ground as the instrument).

For more information about how to connect signals to the external control terminals, see "External Control Connections" in the Quick Start Manual.

8.1 Configuring Voltage Output (VOUTPUT)	p. 174
8.2 Configuring Alarm Output (ALARM)	p. 175
8.3 Configuring External Input/Output (I/O) Terminals	p. 177
External trigger input	p. 179
Trigger output	p. 180
Simultaneously starting measurement using external triggers	p. 182

8.1 Configuring Voltage Output (VOUTPUT)

This section describes how to configure voltage output for use in powering sensors. For more information about how to connect sensors to the voltage output terminals, see “Voltage Output Connections” in the Quick Start Manual.

SET > System > External

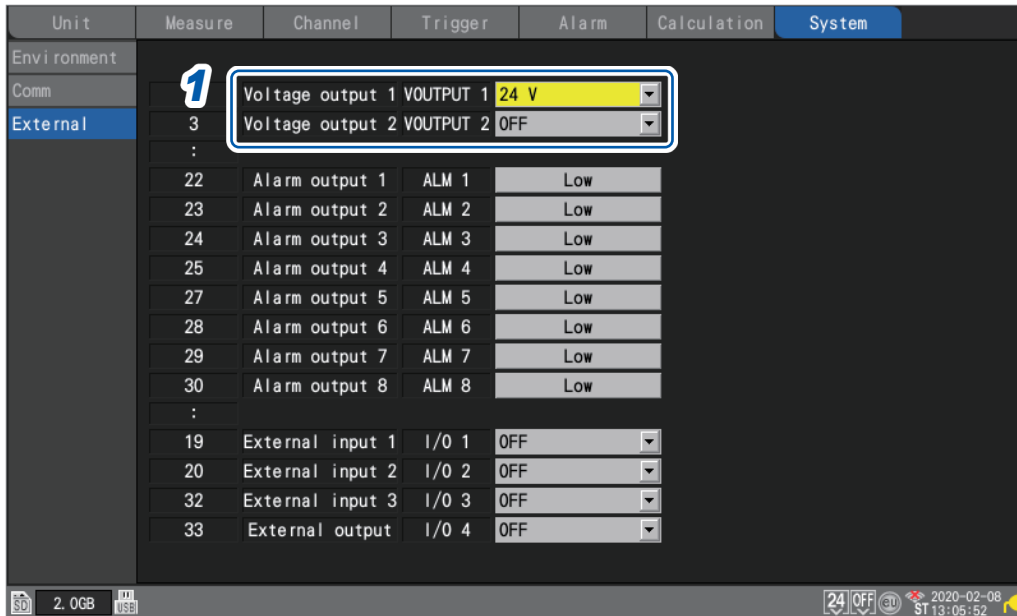

1 Under [Voltage output 1] and [Voltage output 2], select the voltage.

OFF <input checked="" type="checkbox"/>	Does not generate voltage output.
5 V	Outputs 5 V DC.
12 V	Outputs 12 V DC.
24 V	Outputs 24 V DC. (Available only under [Voltage output 1])

Select [12 V] when providing power to the optional Z2000 Humidity Sensor.

Voltage output terminal specifications

Output voltage	OFF, 5 V $\pm 10\%$, 12 V $\pm 10\%$, 24 V $\pm 10\%$ (user-selectable)
Supplied current	Max. 100 mA

8.2 Configuring Alarm Output (ALARM)

This section describes how to set the voltage level for the signal that is output when an alarm condition is satisfied.

For more information about alarms, see “4 Alarm (Alarm Output)” (p. 129).

SET > **System** > **External**

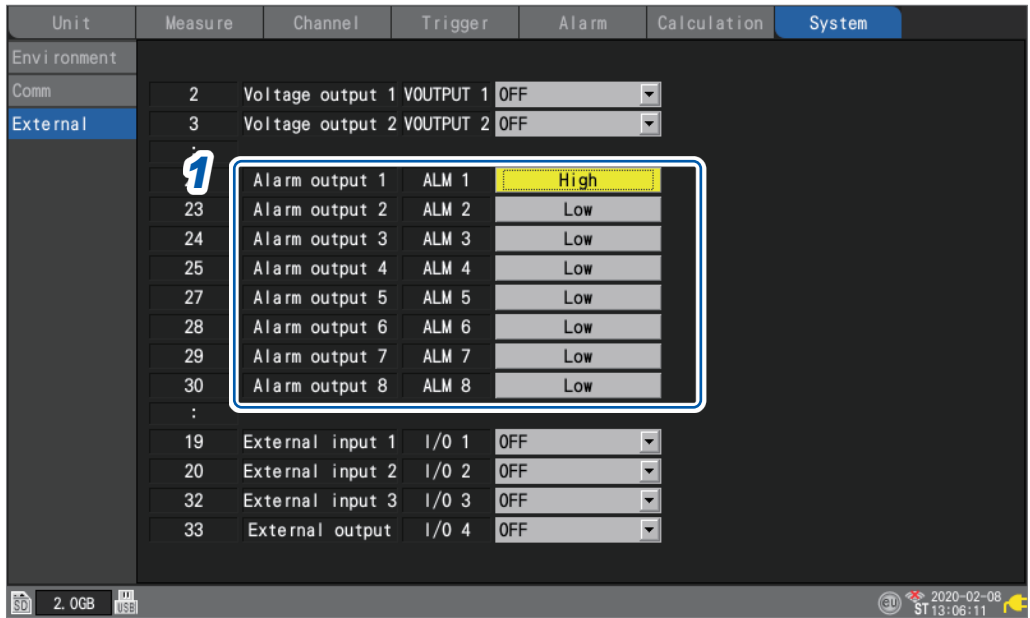

1 Under [Alarm output 1] to [Alarm output 8], select the voltage level you wish to output when outputting an alarm.

Low <input checked="" type="checkbox"/>	Outputs the alarm at low level (0 V to 0.5 V).
High	Outputs the alarm at high level (4.0 V to 5.0 V).

Alarm output terminal specifications

Output type	Open-drain output (with 5 V voltage output)
Output voltage	High level: 4.0 to 5.0 V; low level: 0 to 0.5 V Switchable between high and low level output
Output response time	(Recording interval or data refresh interval, whichever is longer) × 2 + 1 ms + analog response time*1 *1: Varies with filter setting (U8554: 5 ms, with 120 Hz low pass filter)
Maximum switching capacity	5 to 30 V DC, 200 mA
Output pulse width	10 ms or greater

Alarm output terminal circuit diagram and example connection

Select the relay with the contact configuration to perform the desired operation.

The example connection illustrates a circuit in which the relay will operate when the alarm output is low.

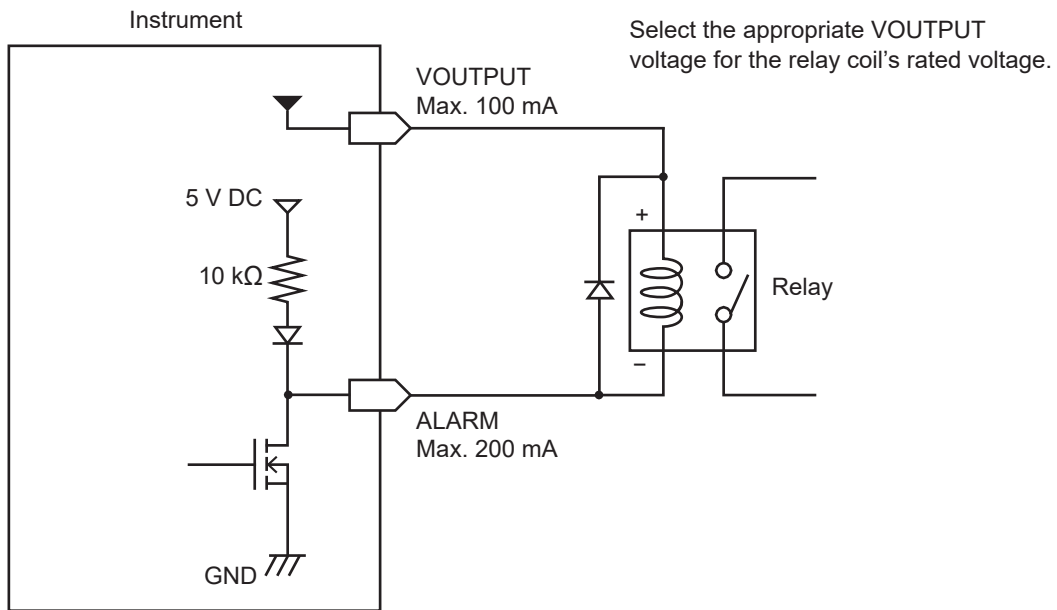

8.3 Configuring External Input/Output (I/O) Terminals

This section describes how to select functionality for the external I/O terminals.

There are four external I/O terminals: I/O 1 to I/O 4.

You can control the instrument to start and stop measurement or input trigger signals.

I/O 1 to I/O 3 are input terminals, while I/O 4 is an output terminal.

SET > System > External

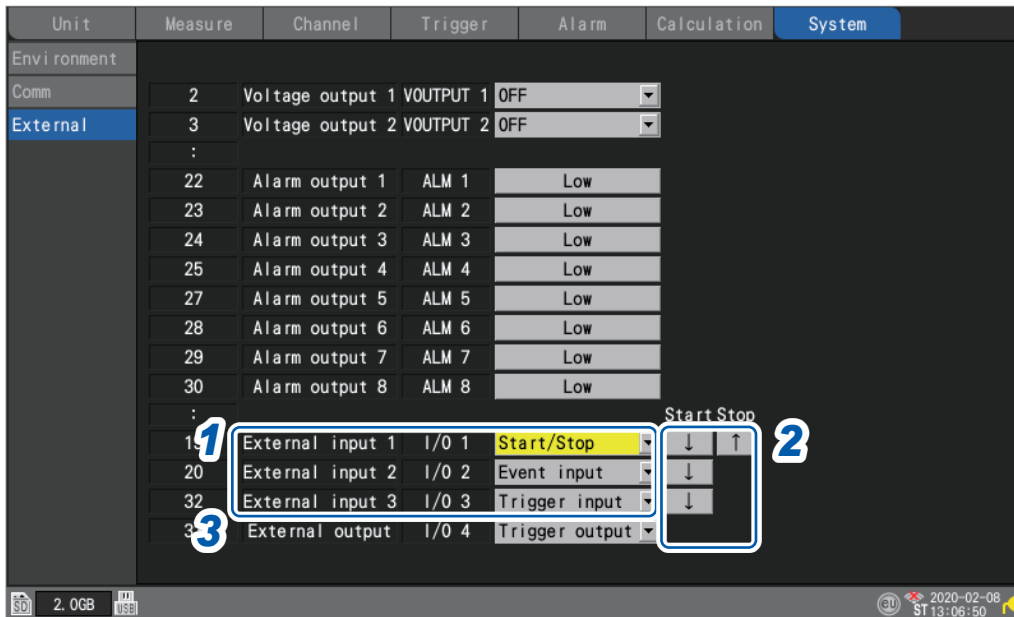

- Under **[External input 1]**, **[External input 2]**, and **[External input 3]**, select the terminal functionality.

OFF <input checked="" type="checkbox"/>	Disables the terminal.
Start	Starts measurement. (Same operation as the START key) This setting is not available for [External input 3] .
Stop	Stops measurement. (Same operation as the STOP key) This setting is not available for [External input 3] .
Start/Stop	Stops or start measurement when the signal level changes. This setting is not available for [External input 3] .
Trigger input	Activates a trigger. This setting is not available for [External input 1] or [External input 2] .
Event input	Assigns an event mark.

- Select the edge.

↑	Operates at the rising edge when changing from low level to high level.
↓ <input checked="" type="checkbox"/>	Operates at the falling edge when changing from high level to low level.

- Under **[External output]**, select the terminal functionality.

OFF <input checked="" type="checkbox"/>	Disables the terminal.
Trigger output	Outputs a low-level signal when a trigger activates.

External input terminal (I/O 1, I/O 2, I/O 3) input specifications

Input voltage	0 V to 10 V DC High level: 2.5 V to 10 V; low level: 0 V to 0.8 V
Slope	Rising/falling (user-selectable)
Response pulse width	High level period: 2.5 ms or greater; low level period: 2.5 ms or greater

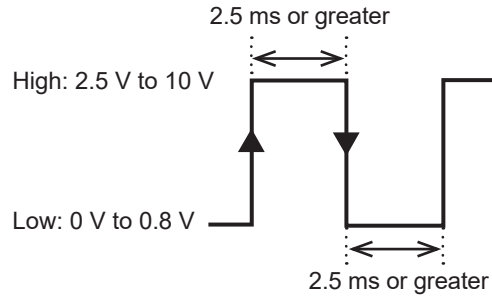
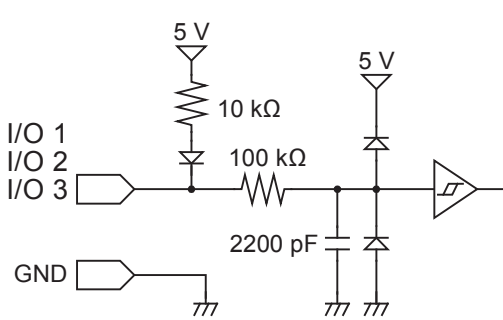

The function will activate at the rising or falling edge, depending on the edge setting.

External output terminal (I/O 4) output specifications

Output type	Open-drain output (with 5 V voltage output)
Output voltage	High level: 4.0 V to 5.0 V; low level: 0 V to 0.5 V Switchable between high and low level output
Maximum switching capacity	5 V to 10 V DC, 200 mA
Output pulse width	10 ms or greater (trigger output)

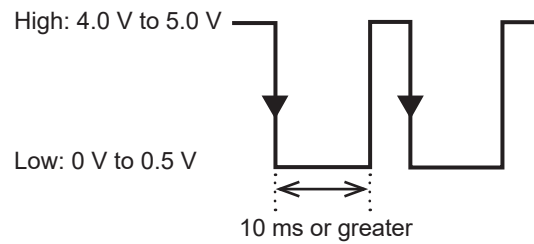
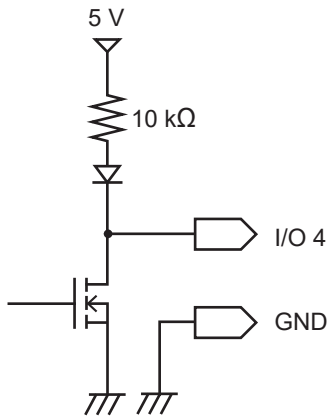

External trigger input

This section describes how to input a signal from an external source to activate a trigger. You can use a signal from another device to start measurement with the instrument. The external input I/O 3 terminal is used for this functionality.

SET > **System** > **External**

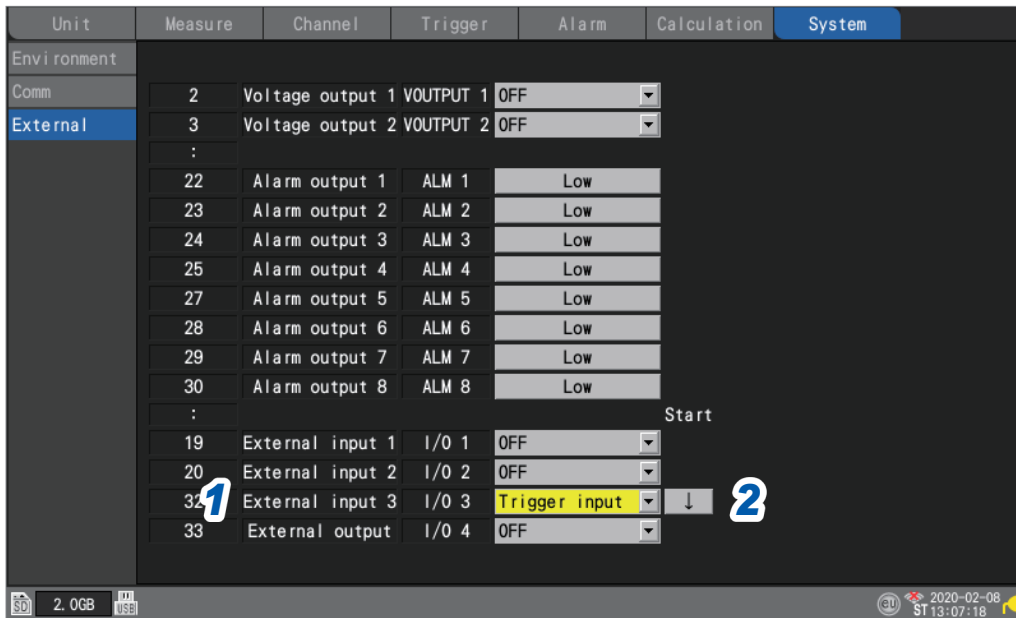

1 Under **[External input 3]**, set the terminal functionality to **[Trigger input]**.

When **[External trigger]** is set to **[ON]**, the parameter will be set to **[Trigger input]**. See “2.5 Applying Triggers Based on External Sources” (p.94).

2 Select the edge at which to activate the trigger.

↑	Activates the trigger at the rising edge when changing from low level to high level.
↓ <input checked="" type="checkbox"/>	Activates the trigger at the falling edge when changing from high level to low level. The trigger will also activate if the I/O 3 and GND terminals are shorted.



It is recommended to actually input the signal and verify whether the external trigger operates.

Trigger output

This section describes how to output a low-level signal when a trigger activates. You can use this capability to notify another device that the instrument has started recording. The external output I/O 4 terminal is used for this functionality.

SET > **System** > **External**

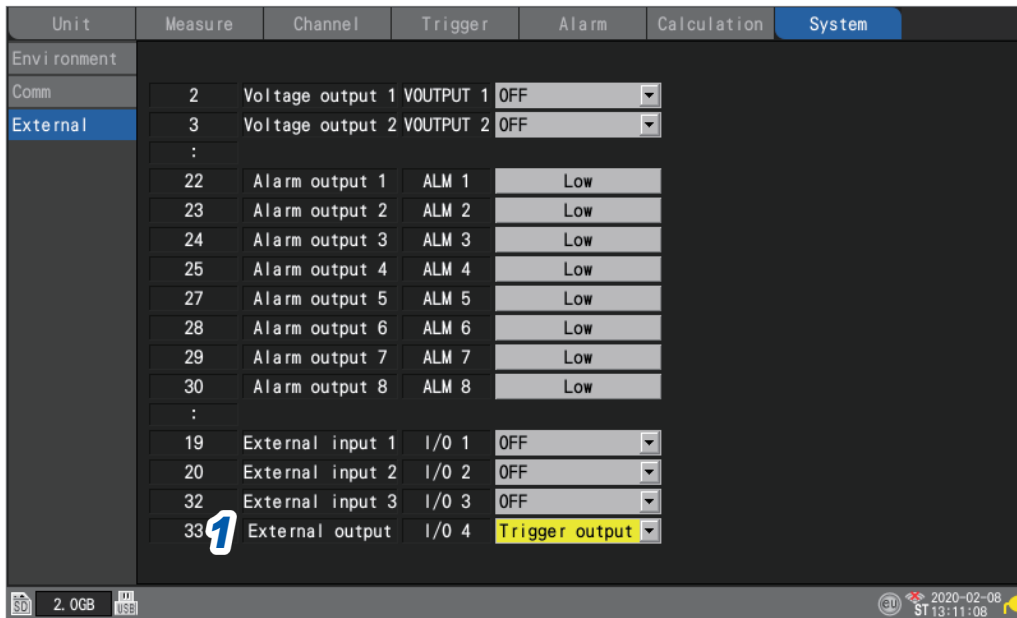

- 1 Under **[External output]**, set the terminal functionality to **[Trigger output]**. A low-level signal will be output when a trigger activates.

Trigger output timing

The timing at which signals appear in trigger output varies with the [Timing] setting. See “2.2 Enabling the Trigger Function” (p.84).

Start

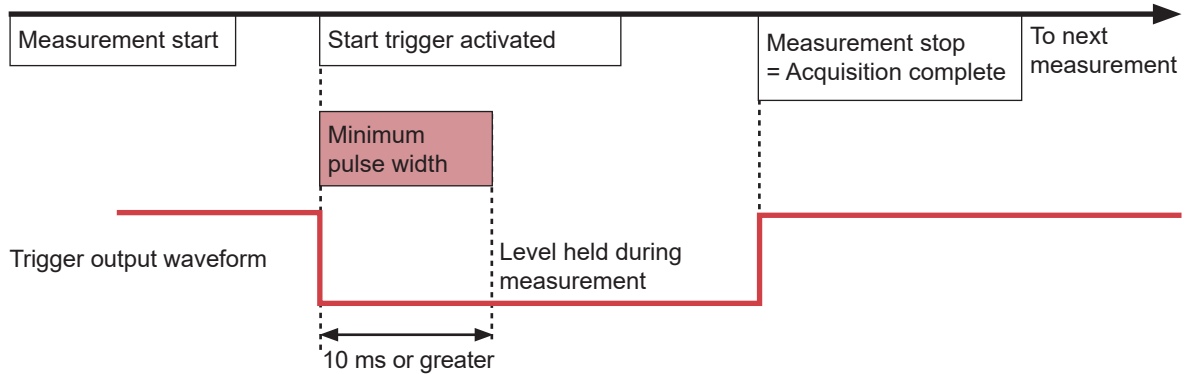

- Trigger output will switch to active when the start trigger activates.
- The pulse will be output for at least 10 ms and held while measurement continues.
- Trigger output will switch to non-active when measurement stops.

Stop

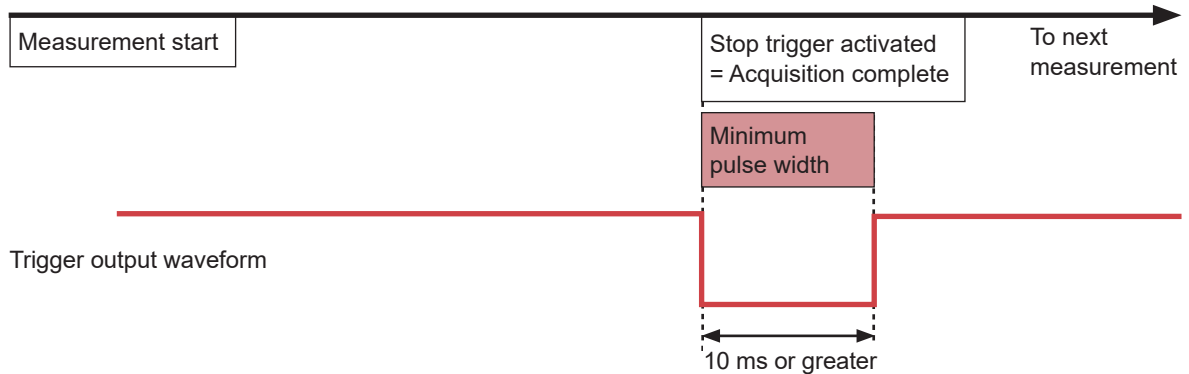

- Trigger output will switch to active when the stop trigger activates.
- The pulse will be output for at least 10 ms, and then trigger output will switch to non-active.

Start & stop

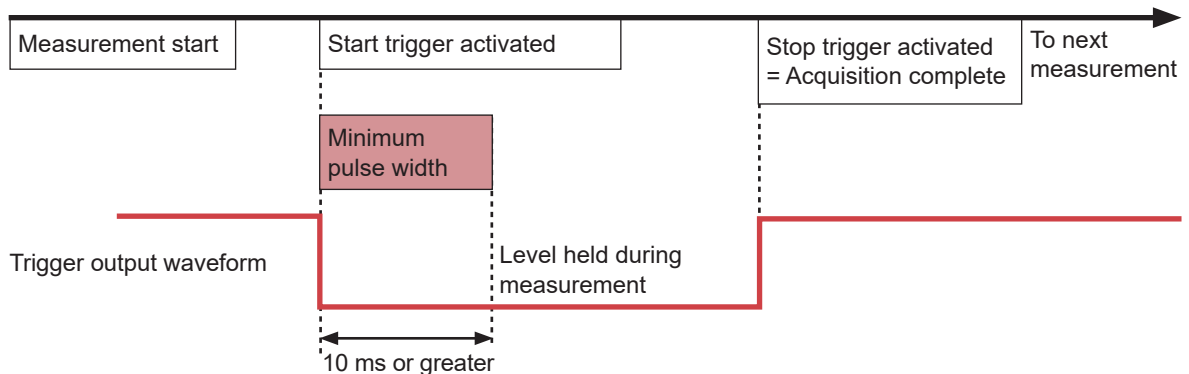

- Trigger output will switch to active when the start trigger activates.
- The pulse will be output for at least 10 ms and held while measurement continues.
- Trigger output will switch to non-active when the stop trigger activates.

Simultaneously starting measurement using external triggers

This section describes how to synchronize the measurement start time for multiple instruments using trigger input and trigger output.

Since each instrument generates its own sampling clock, data acquisition times will diverge if measurement is continued for an extended period of time.

There are two methods for synchronizing measurement start times: daisy chain operation and parallel synchronized operation.

Daisy chain operation

When a trigger activates for any instrument, triggers will also activate for other instruments. When a large number of instruments are connected, divergence among individual devices' trigger times will increase.

Connection method

Connect one instrument's trigger output (I/O 4) to the next instrument's trigger input (I/O 3). Repeat this connection until all the instruments have been connected.

Configuration method

- Set **[Trigger]** to **[ON]** for all the instruments. (p.84)
- Set **[External trigger]** to **[ON]** for all the instruments. (p.94)
- Set **[External input 3]** to **[Trigger input]** and the edge to **[↓]** for all the instruments. (p.179)
- Set **[External output]** to **[Trigger output]** for all the instruments. (p.180)

Example connections

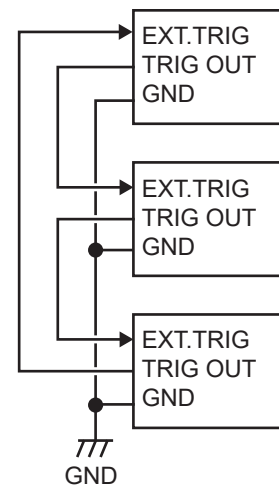

Parallel synchronized operation

Use one instrument as the master (trigger monitoring) and the rest as subordinates.

When a trigger activates for the master instrument, triggers will also activate for the subordinate instruments.

Divergence in trigger times can be minimized using this method, even when the number of connected instruments increases.

Connection method

Connect the master instrument's trigger output (I/O 4) to all subordinate instruments' trigger input (I/O 3).

Configuration method

- Set **[Trigger]** to **[ON]** for all the instruments. (p.84)
- Set **[External trigger]** to **[ON]** for all the subordinate instruments. (p.94)
- Set **[External input 3]** to **[Trigger input]** and the edge to **[↓]** for all the subordinate instruments. (p.179)
- Set **[External output]** to **[Trigger output]** for the master instrument. (p.180)

Example connections

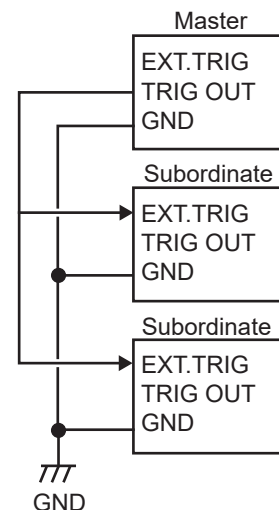

Communicating with a Computer (PC)



This chapter describes how to connect the instrument to a computer.

The instrument and computer must be connected using either a LAN cable or a USB cable.

9.1 Using the Logger Utility	p. 185
9.2 Configuring and Establishing a USB Connection	p. 186
9.3 Configuring and Establishing a LAN Connection	p. 189
9.4 Exporting Acquired Data to a Computer Over Wireless LAN	p. 201
9.5 Performing Remote Measurement with the HTTP Server.....	p. 201
9.6 Acquiring Data Using the FTP Server.....	p. 206
9.7 Sending Data Using the FTP Client	p. 210
9.8 Controlling the Instrument with Communication Commands.....	p. 229

Available functionality

✓: Yes; --: No

Description	LAN	USB	Reference page
Remote operation using the HTTP server function	✓*1	--	p.201
Manual acquisition of data using the FTP server function	✓	--	p.206
Automatic sending of data using the FTP client function	✓	--	p.210
Measurement using programs written in languages such as Visual Basic®	✓*2	✓	p.229

*1: Not available during measurement using programs written in languages such as Visual Basic®.

*2: Real-time data cannot be acquired at a recording interval of less than 1 s. Data can be acquired after measurement has stopped, even when using a recording interval of less than 1 s. For more information about creating measurement programs, see the “Communication Commands User Manual” on the included CD (application disc).



9.1 Using the Logger Utility

A software application called Logger Utility comes with the instrument.

- You can analyze measurement data.
- You can convert measurement data (from binary format to CSV format).

Supported models

LR8450, LR8450-01, LR8400, LR8401, LR8402, LR8410, LR8416, LR8431, LR8432, 8423

For more information about how to install and use the Logger Utility, see “Logger Utility User Manual” (PDF file) on the included CD.



Communicating with a Computer (PC)



9.2 Configuring and Establishing a USB Connection

This section describes how to connect the instrument to a computer with the accompanying USB cable.

- You can load data from an SD Memory Card to a computer. (p. 126)
- You can control the instrument using communication commands. (p. 229)

Install the USB driver before connecting the instrument to the computer for the first time.

Installing the USB driver

Install the USB driver as described below.

1 Execute an install file of the USB driver. (Windows 7 or Windows 8)

Run **[DriverSetupWin7Win8.msi]** on the CD.

If you have already installed the Logger Utility, you can run the file from the following location:
[c:\Program Files(x86)\HIOKI\LoggerUtility\Driver\DriverSetupWin7Win8.msi] *

(Windows 10)

Run **[DriverSetupWin10.msi]** on the CD.

If you have already installed the Logger Utility, you can run the file from the following location:
[c:\Program Files(x86)\HIOKI\LoggerUtility\Driver\DriverSetupWin10.msi] *

*: Follow the procedure to install the Logger Utility. It will be installed in the **[Program Files(x86)]** on the C drive.



2 Click **[Next]**.

To change the installation location (not usually necessary)

Click **[Browse...]** and change the folder into which to install the driver.

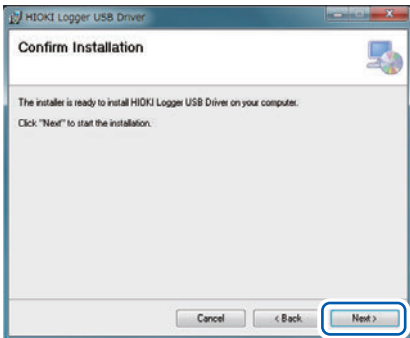

3 Click **[Next]**.

The installation will begin.

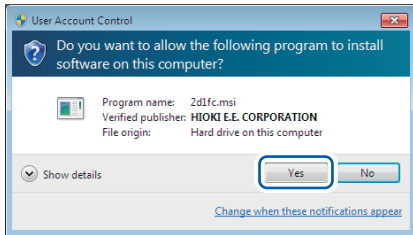
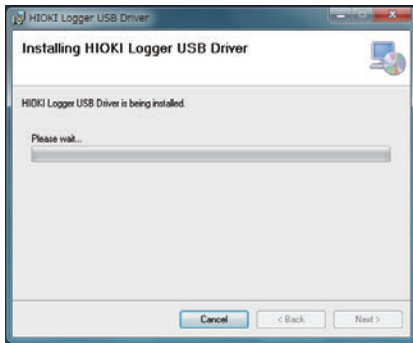

Windows 7, Windows 8, or Windows 10

A dialog asking for permission to continue will be displayed. Click **[Yes]** to continue.

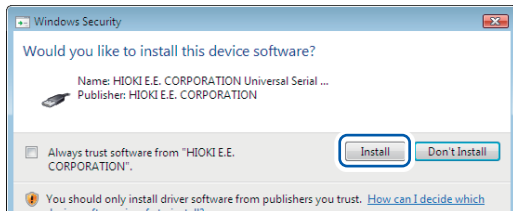

A dialog box asking for permission to install the software will be displayed.

Select the **[Always trust software from "HIOKI E.E. CORPORATION".]** checkbox and click **[Install]**.

The installation will complete, and a dialog box will be displayed.

4 Click [Close].

This completes installation of the USB driver.

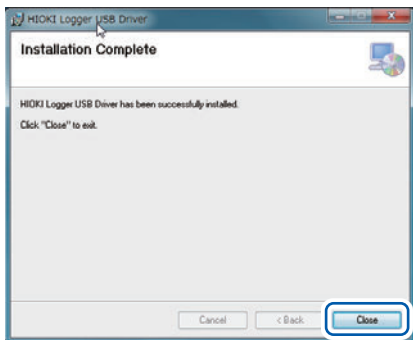

Connecting the instrument to the computer with a USB cable

This section describes how to connect the instrument to a computer with a USB cable.

NOTICE



- **Do not unplug the USB cable while the instrument is sending or receiving data.**
Doing so could damage the instrument.

- **Turn off the instrument and computer before connecting or disconnecting the USB cable.**



Failure to do so could cause the instrument to malfunction or damage it.

- **Ensure the instrument and computer are grounded at the same potential.**

Connecting the USB cable while the ground potentials differ between the instrument and computer could cause the instrument to malfunction or damage it.

Instructions

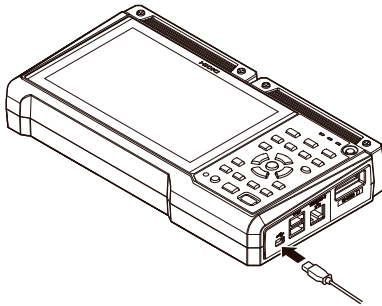

- 1** Insert the USB cable plug into the instrument's USB cable connector, exercising care to ensure that the plug is oriented properly.

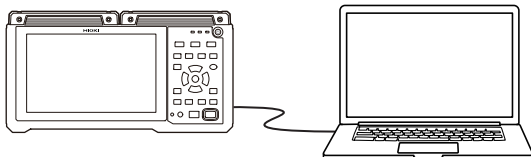

- 2** Connect the other end of the USB cable to the computer's USB connector.

You cannot use both the Logger Utility and communication commands at the same time over the USB connection. Allow at least 30 s to switch between the Logger Utility and communication commands.

9.3 Configuring and Establishing a LAN Connection

- This section describes how to connect the instrument to a computer with a LAN cable.
- You can remotely control the instrument (to configure settings, acquire data, or monitor its screen) using a standard web browser such as Internet Explorer®. (HTTP server) (p.201)
 - You can download files from storage media (an SD Memory Card or USB Drive) to a computer. (FTP server) (p.206)
 - You can set up the system so that waveform files stored on instrument media (in binary format) are automatically sent over the network or to the FTP server on a remotely located computer. (FTP client) (p.206)
 - You can control the instrument using communication commands. (p.229)

IMPORTANT

- Be sure to configure the LAN settings before connecting the instrument to a network.
- Changing the settings while the instrument is connected to a network could cause the instrument to be assigned the same IP address as another device on the LAN or incorrect address data to be sent to the network.

Checking settings before connecting the instrument

Different settings are used depending on whether you wish to connect the instrument to an existing network or to connect the instrument to a single computer.

Connecting the instrument to an existing network

You will need to have your network system administrator (department) assign the following settings in advance. Be sure that the instrument is not using the same IP address as any other device on the network.

DHCP	DHCP: Use or not use
Host name IP address Subnet mask	Hostname IP address Subnet mask: _____._____._____._____ (The IP address and subnet mask are unnecessary if using DHCP.)
Port number	TCP/IP port number to use: ____X (default setting: 880x) (Specify at least the first 3 digits of the 4- or 5-digit port number. The last digit is reserved for use by the instrument. Specify when the default setting of 8800 to 8809 cannot be used.)
Gateway	Gateway: Use or not use IP address (if using): _____._____._____._____ (Will be acquired from the DHCP server if using DHCP.)
DNS	DNS: Use or not use IP address (if using): _____._____._____._____ (Will be acquired from the DHCP server if using DHCP.)

Connecting the instrument to a single computer (local network with no external connections)

The following addresses are recommended if there is no network administrator or if you are responsible for configuring the settings yourself:

Example settings

DHCP		OFF
Host name		Set as desired (unique setting required).
IP address	Computer	192.168.1.1
	Logger 1	192.168.1.2
	Logger 2	192.168.1.3 (assign sequentially)
	↓	↓
Subnet mask		255.255.255.0
Port number		880X
Gateway		OFF
DNS		OFF

Settings

Using DHCP (Dynamic Host Configuration Protocol)	DHCP allows the instrument to automatically acquire and configure its IP address and other settings. When DHCP is enabled, the instrument will automatically acquire and configure the IP address, subnet mask, and gateway if it finds an operating DHCP server on the network.
Host name	Indicates the name of the instrument on the network. Be sure that the instrument's hostname is not being used by any other device on the network. Since the instrument does not support dynamic DNS, the set hostname will not be registered in the DNS.
IP address	Indicates the address used to distinguish individual devices connected to the network. Be sure that the instrument's IP address is not being used by any other device on the network. If DHCP is enabled, the IP address will be set automatically.
Subnet mask	Divides the IP address into one part that indicates the network and another that indicates the instrument. Use the same setting as other devices that are connected to the same network. If DHCP is enabled, the subnet mask will be set automatically.
Gateway IP address	<ul style="list-style-type: none"> Connecting the instrument to a network If the computer (communications device) is connected to a different network than the instrument, set to [ON] and specify the device that will serve as the gateway. If the computer is on the same network, the same setting as the default gateway in the computer's settings can generally be used. Connecting the instrument to a single computer If connecting the instrument to the same hub, set to [OFF]. If DHCP is enabled, the setting will be acquired from DHCP.
DNS (Domain Name System)	When DNS is enabled, you can specify the device you wish to communicate with by name instead of IP address. (IP addresses consist of a series of numbers and are difficult to remember. Devices can be specified using names instead of IP addresses to make the setup process more intuitive.) If a server that can convert names to IP addresses is operating on the network, IP addresses can be checked based on names by querying the server. If DHCP is enabled, the setting will be acquired from DHCP.

Username and password for authentication purposes

You can impose limitations on connections when you log into the FTP of the instrument and use a web browser of a computer.

See "FTP server connection limitations (FTP authentication)" (p.208).



Configuring the computer's network settings

These settings are configured in the same way, regardless of whether you are connecting the instrument to one computer or multiple instruments to a single computer via a hub.

This explanation envisions the following network:

- IP address: 192.168.1.0/24 (network address)
or 192.168.1.1 (private IP address*)
- Subnet mask: 255.255.255.0

*: The IP address can be set as desired, but use of a private IP address is recommended.

Windows 7, Windows 8, or Windows 10

1 Under [Control Panel] > [Network and Sharing Center] > [Change adapter settings], display the computer's network connections.

2 Right-click the network adapter icon (with a name such as [Local area connection] or [Ethernet]) and select [Properties].

3 Select [Internet Protocol Version 4 (TCP/IPv4)] and click [Properties].

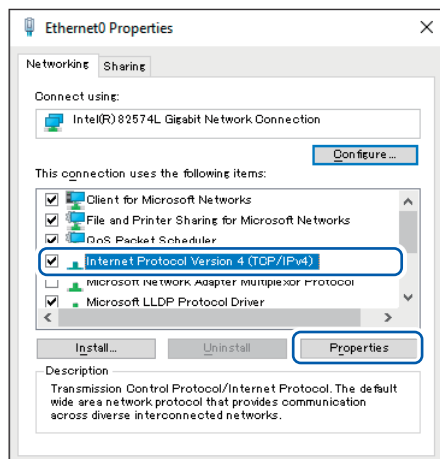

4 Enter the [IP address] and [Subnet mask] and click [OK].

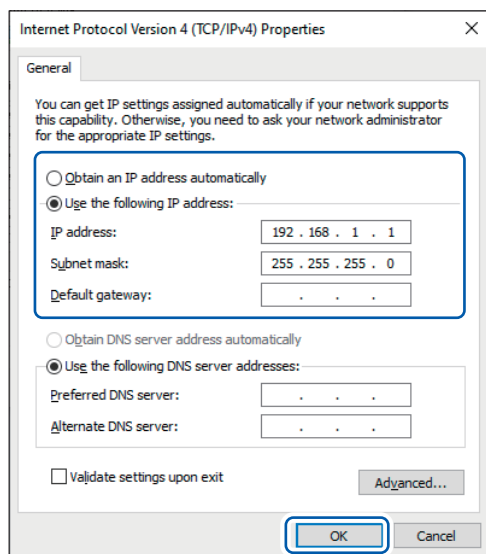

Configuring the instrument's LAN settings

SET > System > Comm

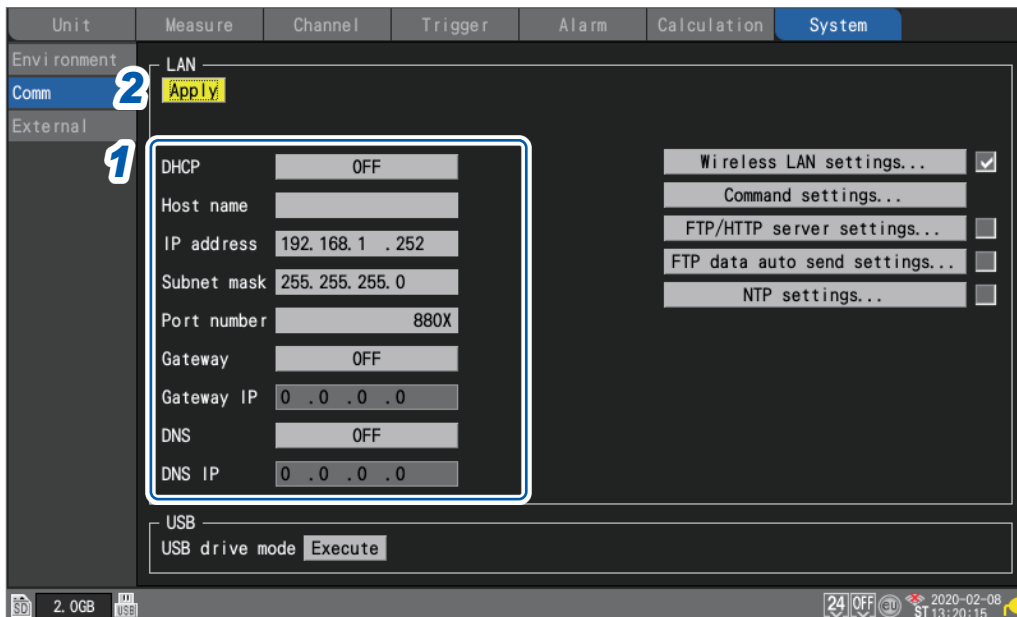

1 Configure the settings.

See “Configuring LAN settings” (p.194).

2 Press the **ENTER** key while **[Apply]** is selected.

The LAN connection will be enabled (the USB connection may be interrupted).

LAN configuration process

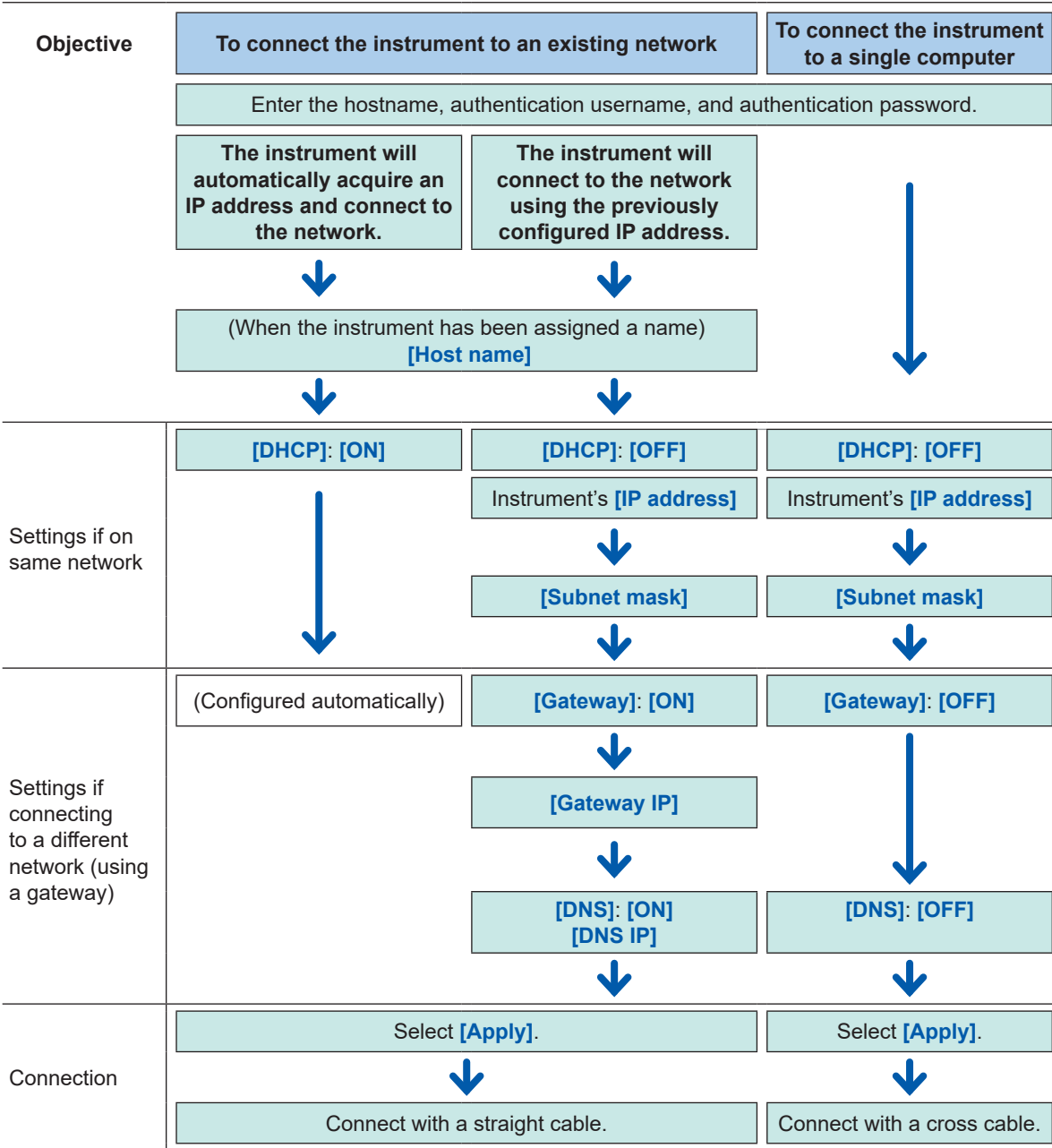

Communicating with a Computer (PC)

Configuring LAN settings

To communicate with the instrument over the LAN, configure the following settings:

- **[DHCP]**

If **[DHCP]** is set to **[ON]**, the instrument will automatically acquire the IP address and subnet mask.

OFF <input checked="" type="checkbox"/>	Disables the DHCP function.
ON	Enables the DHCP function.

- **[Host name]**

Specify the instrument's hostname.

String of up to 12 single-byte characters (example: **LOGGER**)

- **[IP address]**

Set the instrument's IP address.

_. _ . _ . _ (_ : 0 to 255) (example: **192.168.1.2**)

- **[Subnet mask]**

_. _ . _ . _ (_ : 0 to 255) (example: **255.255.255.0**)

- **[Port number]**

Set the number of the TCP/IP port used by the instrument.

The last digit cannot be set as it is used by the instrument's firmware.

____ (_ : 0 to 9) (example: **880X**)

- **[Gateway]**

If **[DHCP]** is set to **[ON]**, the gateway will be set automatically.

OFF , **ON**

- **[Gateway IP]**

If **[Gateway]** is set to **[ON]**, set the IP address of the device that will serve as the gateway.

_. _ . _ . _ (_ : 0 to 255)

- **[DNS]**

Select whether to use DNS.

OFF , **ON**

- **[DNS IP]**

If **[DNS]** is set to **[ON]**, set the DNS server's IP address.

_. _ . _ . _ (_ : 0 to 255)

Example settings

- Connecting the instrument to a single computer

DHCP	OFF
Host name	LOGGER
IP address	192.168.1.2
Subnet mask	255.255.255.0
Port number	880X
Gateway	OFF
DNS	OFF

- Connecting multiple instruments to a computer via a hub

This section describes how to connect the instrument to a local network without any external connections.

It is recommended to use a private IP address.

Configure the settings as follows so that only one device uses a given hostname and IP address.

Device 1

Host name	LOGGER
IP address	192.168.1.2

Device 2

Host name	LOGGER2
IP address	192.168.1.3

Device 3

Host name	LOGGER3
IP address	192.168.1.4

Shared settings

DHCP	OFF
Subnet mask	255.255.255.0
Port number	880X
Gateway	OFF

Connecting the instrument to a computer with a LAN cable

This section describes how to connect the instrument to a computer with a LAN cable.

NOTICE



■ **Do not unplug the LAN cable while the instrument is sending or receiving data.**
Doing so could damage the instrument.

■ **Turn off the instrument and computer before connecting or disconnecting the LAN cable.**

Failure to do so could cause the instrument to malfunction or damage it.

■ **Ensure the instrument and computer are grounded at the same potential.**

Connecting the LAN cable while the ground potentials differ between the instrument and computer could cause the instrument to malfunction or damage it.



■ **Connect the LAN cable securely.**

Failure to do so could cause the instrument to malfunction or damage it.

■ **If routing the LAN cable outdoors or over a distance of more than 30 m, attach a LAN surge protector or other suitable protective device.**

Failure to do so could cause damage to the instrument due to increased susceptibility to the effects of induced lightning.

LAN connector on the instrument

Right side

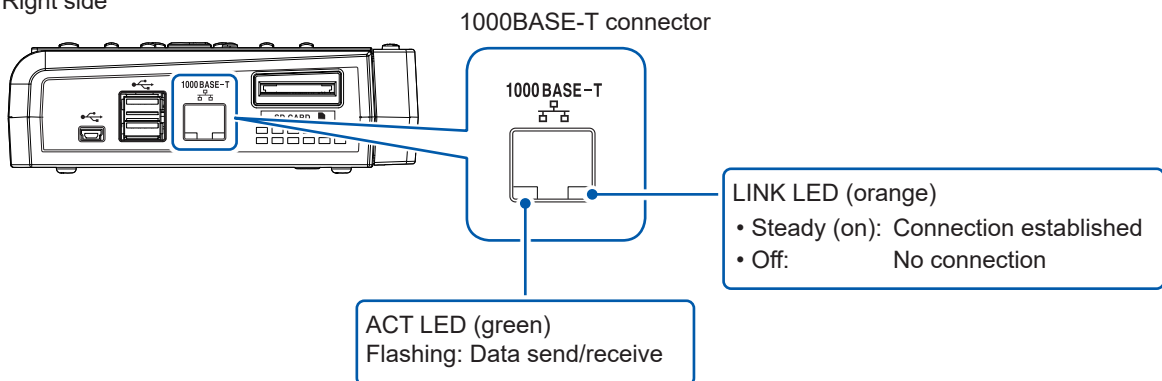

The LINK LED will light up when the instrument has connected to the network, indicating that the connection can be used. If the LED fails to illuminate, there may be a malfunction of the instrument or connected device or a wire break in the LAN cable.

Connecting the instrument to a single computer

You will need: 9642 LAN Cable (×1)

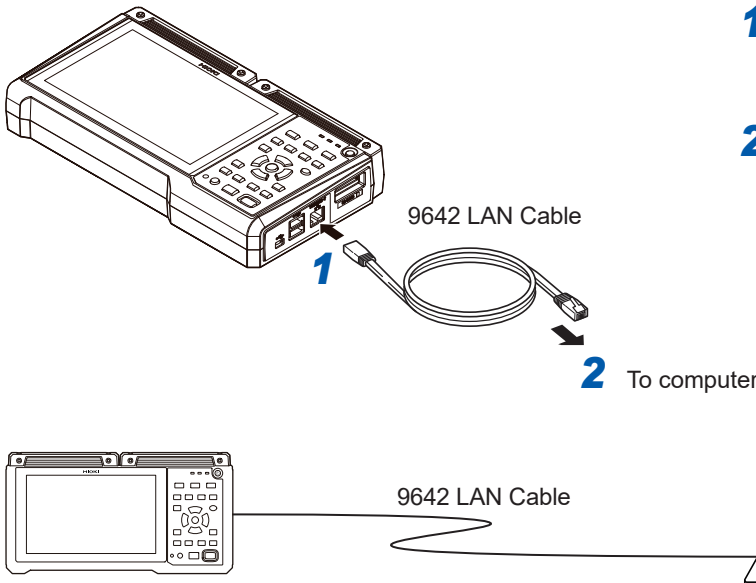

- 1** Connect the 9642 LAN Cable to the LAN connector on the instrument.
- 2** Connect the other end of the cable to the computer's LAN connector.

Connecting multiple instruments to a computer via a hub

You will need: 9642 LAN Cable (×2), hub

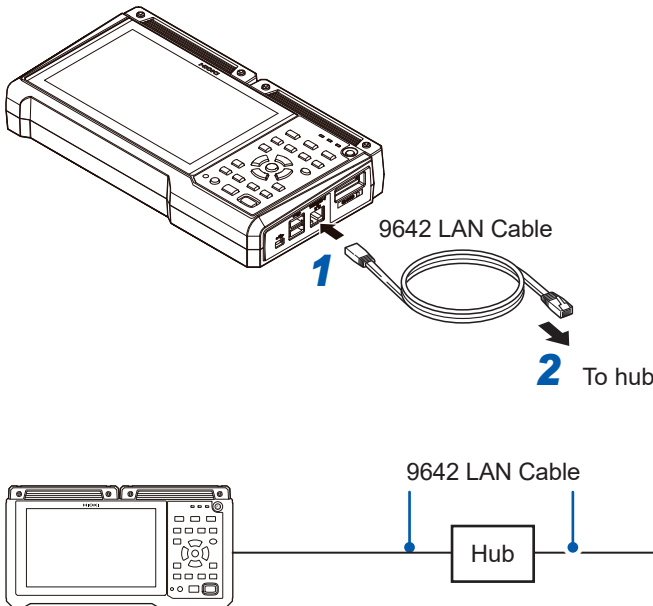

- 1** Connect the 9642 LAN Cable to the LAN connector on the instrument.
- 2** Connect the other end of the cable to one of the hub's LAN connectors.

Communicating with a Computer (PC)

Troubleshooting LAN connections

Are the cables connected properly?

- There may be a faulty contact in the connector. Disconnect and reconnect the cable.
- The LINK LED on the instrument's LAN connector will light up once a connection has been established.

Has the computer's IP address been set properly?

- Check the IP address, subnet mask, and gateway address set for the computer's network interface.

1 Press the **Windows** key and the **R** key at the same time.

The **[Run...]** dialog box will be displayed.

2 Enter **CMD** and press the **ENTER** key.

The **[CMD.exe]** window will open.

3 When the cursor starts flashing, enter **ipconfig/all** and press the **ENTER** key.

Can the instrument and computer communicate?

- If the instrument and computer's IP addresses have been set properly, you can check whether the computer can communicate with the instrument using the ping protocol.

1 Press the **Windows** key and the **R** key at the same time.

The **[Run...]** dialog box will be displayed.

2 Enter **CMD** and press the **ENTER** key.

The **[CMD.exe]** window will open.

3 Once the cursor starts flashing, enter **ping XXX.XXX.X.X** (using the IP address you wish to verify) and press the **ENTER** key.

If an IP address can be obtained from the hostname using DNS, you may also enter the hostname.

For example, if the instrument's IP address is 192.168.1.2, enter **ping 192.168.1.2**.

4 Check the computer's display.

Output like the following indicates normal connectivity. The expression *time* indicates the amount of time required for the operation to complete.

Pinging 192.168.1.2 with 32 bytes of data:

Reply from 192.168.1.2: bytes=32 time<10ms TTL=32

Reply from 192.168.1.2: bytes=32 time<10ms TTL=32

Reply from 192.168.1.2: bytes=32 time<10ms TTL=32

Reply from 192.168.1.2: bytes=32 time=1ms TTL=32

Output such as the following indicates a connectivity issue. Check the cable connection.

Pinging 192.168.1.2 with 32 bytes of data:

Reply from 192.168.1.2: Host is down.

Reply from 192.168.1.2: Host is down.

Reply from 192.168.1.2: Host is down.

Reply from 192.168.1.2: Host is down.

9.4 Exporting Acquired Data to a Computer Over Wireless LAN

Configuring and Establishing a Wireless LAN Connection (LR8450-01 only)

The LR8450-01 is equipped with various features that take advantage of wireless LAN communications.

When you select the station function, the following functions will be enabled:

- Setting configuration and recording control using communication commands
- Manual data acquisition using the FTP server
- Automatic data sending using FTP (FTP client)
- Remote operation using the HTTP server
- NTP client function

SET > System > Comm

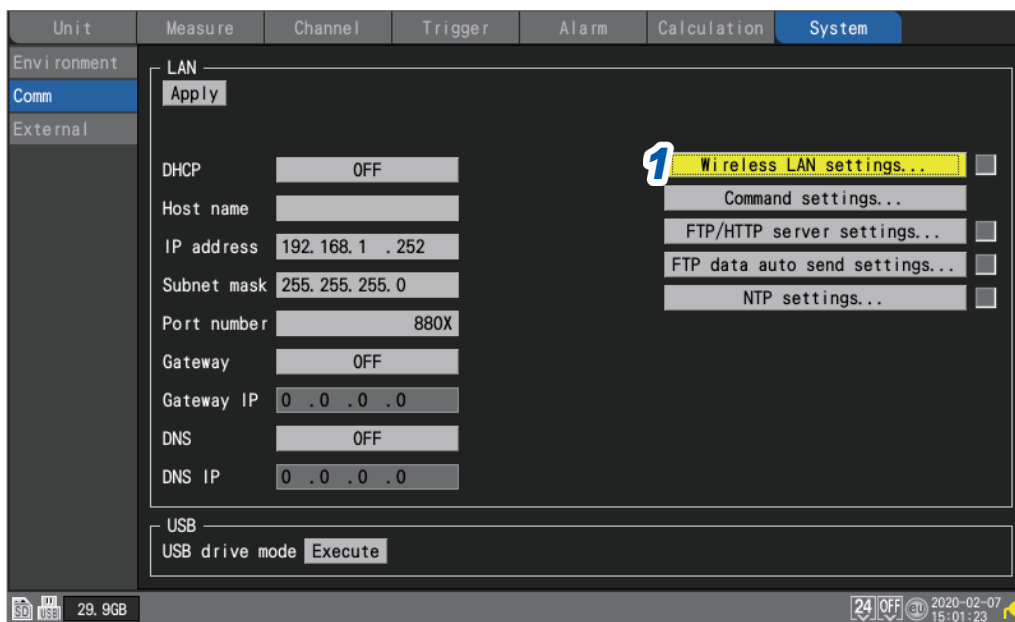

- 1 Press the **ENTER** key while **[Wireless LAN settings...]** is selected. The setting window will open.



- 2** Select the **[Use wireless function]** check box.
- 3** Under **[Mode]**, select a setting.

Station <input checked="" type="checkbox"/>	Works as a terminal that can connect to an access point in the wireless LAN.
--	--

The setting cannot be changed from **[Station]**. New functions will be available in the future.

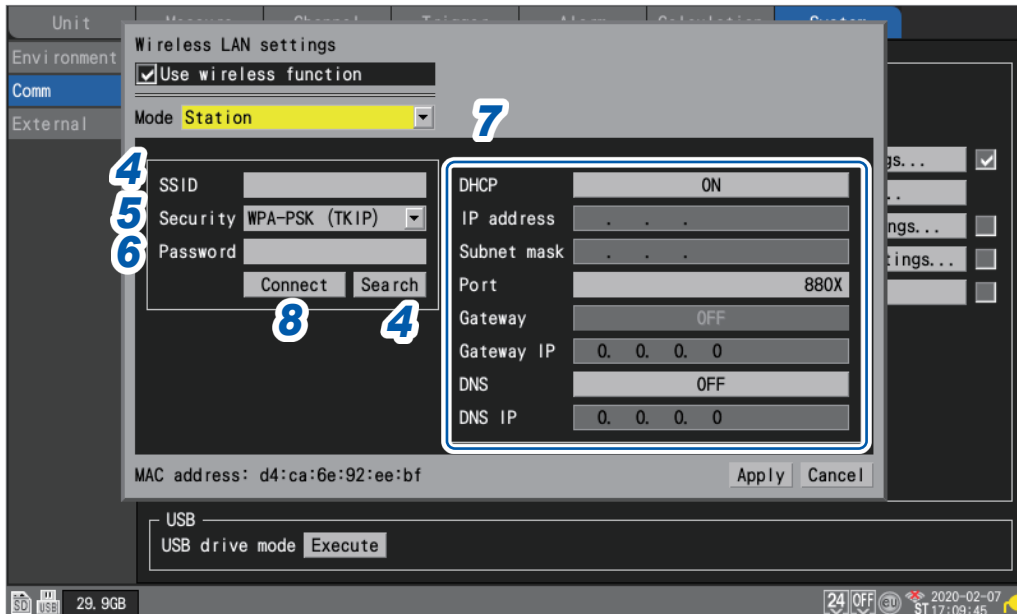

- 4** Under **[SSID]**, set an identification name for an access point.
Press the **ENTER** key while **[Search]** is selected to search wireless equipment close to the instrument for their SSIDs. Choose the SSID you wish to connect to.

- 5** Under **[Security]**, select an encryption protocol.

Off	Does not encrypt data.
WPA-PSK (TKIP) <input checked="" type="checkbox"/>	Encrypts data with WPA.
WPA2-PSK (AES)	Encrypts data using WPA2.

- 6** When encryption is enabled, set a password to connect to the access point.

- 7** Configure each setting.
See "Configuring LAN settings" (p. 194).

- 8** Press the **ENTER** key while **[Connect]** or **[Disconnect]** is selected.
You can manually connect the instrument to or disconnect it from the access point.

9.5 Performing Remote Measurement with the HTTP Server

This section describes how to use the instrument's HTTP server function to control it remotely using a computer.

You can configure instrument settings and monitor screens using a standard browser such as Internet Explorer®.

To perform remote measurement using the HTTP server function, you must configure LAN settings and use a LAN connection.

Remote measurement using the HTTP server function is not available when performing measurement using a program written in a language such as Visual Basic®.

Connecting to the HTTP server

This section describes how to connect to the HTTP server using a computer.

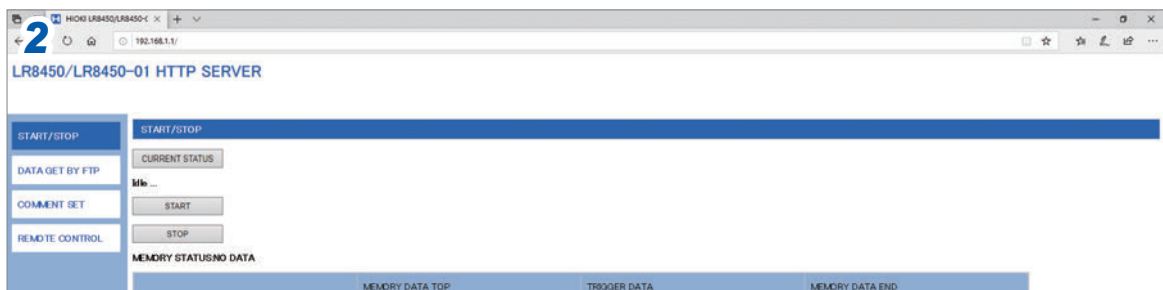

- 1** Launch Internet Explorer® on the computer.
- 2** Enter the instrument's address into the address bar (for example, <http://192.168.1.2>).
- 3** (When the instrument's [\[FTP/HTTP authentication settings\]](#) setting is [\[ON\]](#)) Enter the username and password to log in.

Set a username and password to prevent inadvertent operation of the HTTP function by other users.

If you plan to access the instrument frequently from multiple computers, set the [\[FTP/HTTP authentication settings\]](#) setting to [\[OFF\]](#).

See "FTP server connection limitations (FTP authentication)" (p.208).

It is recommended to use Internet Explorer® 11 or later.
Set the security level to [\[Medium\]](#) or [\[Medium-high\]](#).

If nothing appears on the HTTP screen

Perform the following steps.

- 1** Under the Internet Explorer® settings, click **[Tools] > [Internet options]**.
- 2** Enable **[Use HTTP1.1]** on the **[Advanced]** tab and disable **[Use HTTP1.1 through proxy connections]**.
- 3** Under **[LAN settings]** on the **[Connections]** tab, disable the **[Proxy server]** setting.

Check whether you can communicate with the instrument over the LAN connection.

See “Troubleshooting LAN connections” (p.198).

If the remote control screen alone is not displayed

Unexpected operation may result if you attempt to control the instrument from multiple computers at the same time.

Operate the instrument from one computer at a time.

Remote control using a browser

This section describes how to display the instrument's screen in a browser.

You can control the instrument remotely by clicking keys shown in the browser. However, power key operation and attempts to engage the key lock (pressing and holding the **ESC** key) are ignored.



- 1** Launch Internet Explorer® on the computer.
- 2** Enter the instrument's address into the address bar (for example, <http://192.168.1.2>).
- 3** Click **[REMOTE CONTROL]**.

The instrument screen will be displayed. The keys provided by the instrument will be shown on the screen.

- 4** Use the mouse to click keys to control the instrument remotely.

You can perform the same operations as by pressing the instrument's keys.

You can select three screen refresh intervals:

1 s, 10 s, 30 s

Starting and stopping measurement

This section describes how to start and stop measurement from a browser.

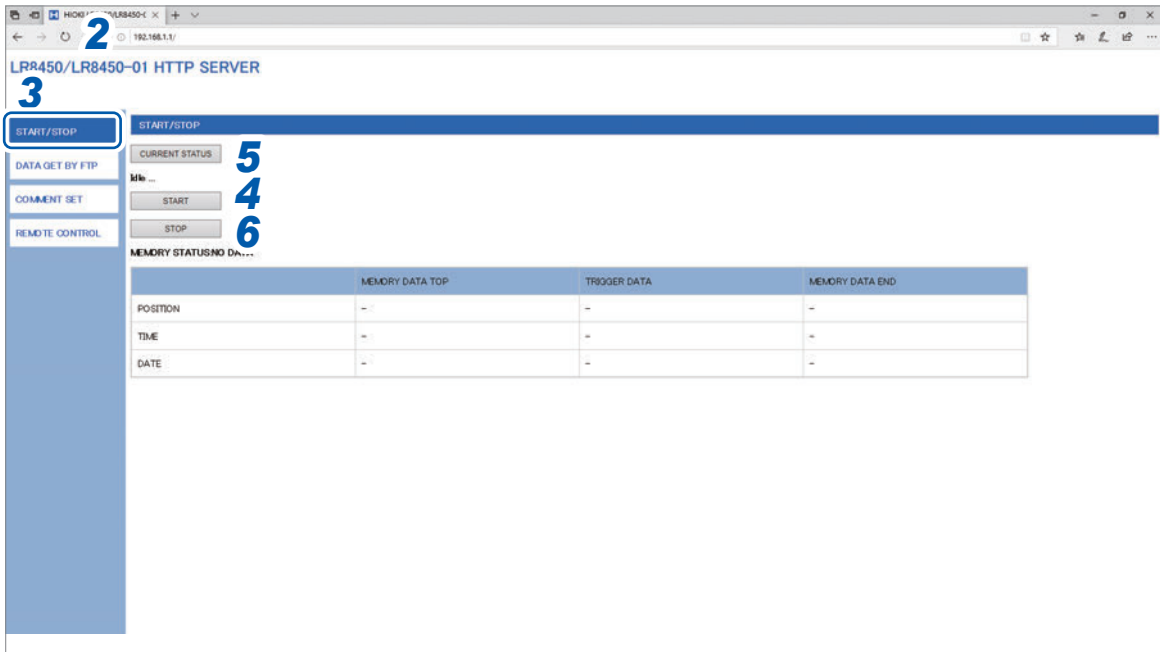

- 1** Launch Internet Explorer® on the computer.
- 2** Enter the instrument's address into the address bar (for example, <http://192.168.1.2>).
- 3** Click **[START/STOP]**.
The **[START/STOP]** screen will be displayed.
- 4** Click **[START]**.
Measurement will start.
- 5** Click **[CURRENT STATUS]** (as necessary).
The status of measurement on the instrument will be displayed.
- 6** Click **[STOP]**.
Measurement will stop.

Entering comments

This section describes how to enter title and channel comments from a browser.

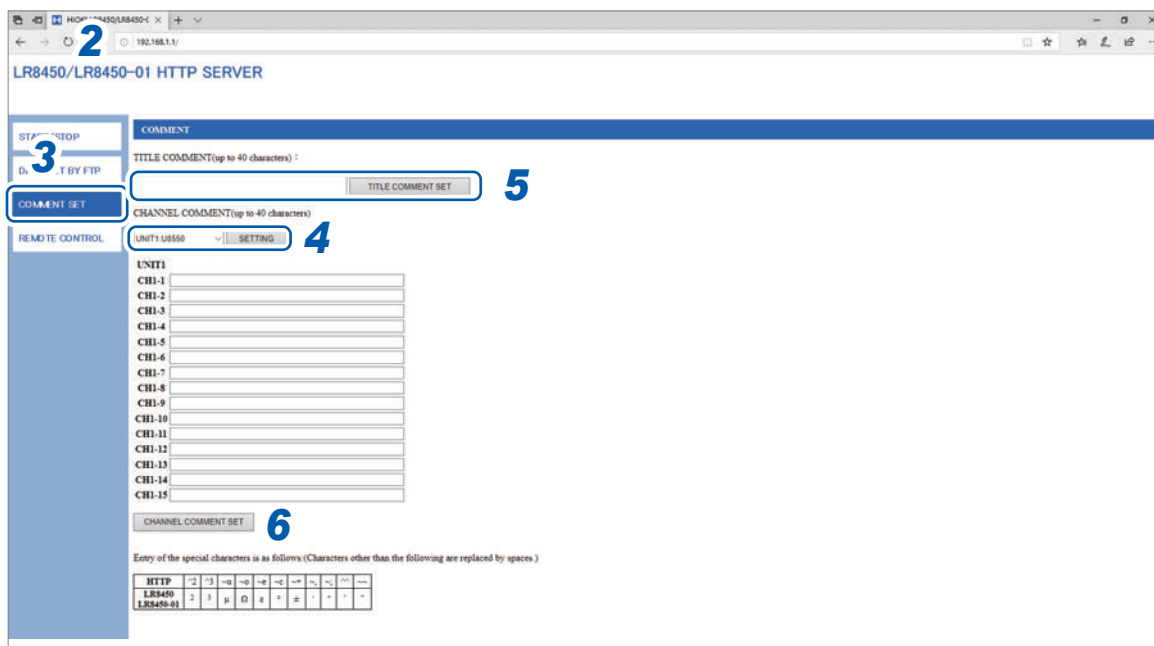

- 1** Launch Internet Explorer® on the computer.
 - 2** Enter the instrument's address into the address bar (for example, <http://192.168.1.2>).
 - 3** Click **[COMMENT SET]**.
Comments that have been entered on the instrument will be displayed.
 - 4** Select the module for which to display comments and click **[SETTING]**.
Channel comments for the selected module will be displayed.
 - 5** Enter a title comment and click **[TITLE COMMENT SET]**.
The title comment entered in the browser will be applied to the instrument.
 - 6** Enter channel comments and click **[CHANNEL COMMENT SET]**.
The channel comments entered in the browser will be applied to the instrument.
- The instrument's comments cannot be changed while measurement is in progress.
 - ASCII characters and JIS No. 1 standard *kanji* characters will be displayed properly on the instrument. Other characters may not be displayed properly on the instrument.

9.6 Acquiring Data Using the FTP Server

This section describes how to use the instrument's FTP server function to acquire files from the instrument using a computer.

The file transfer protocol (FTP) is a protocol for sending files over a network.

You can use an FTP client on a computer to download files from an SD Memory Card or USB Drive connected to the instrument.

You'll connect to the HTTP server from a computer.

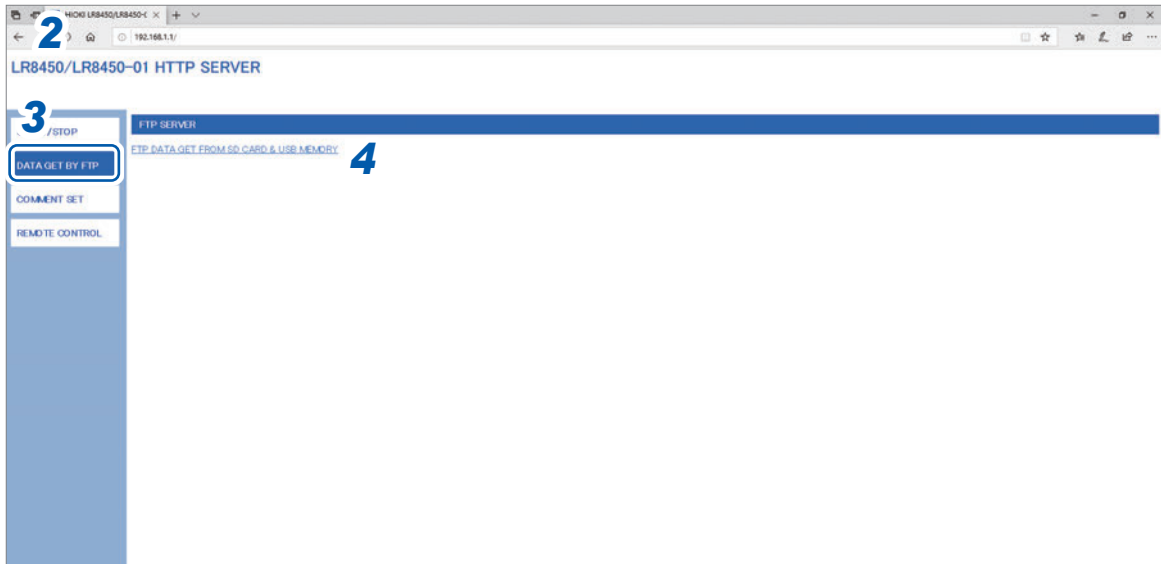

- 1** Launch Internet Explorer® on the computer.
- 2** Enter the instrument's address into the address bar (for example, **http://192.168.1.2**).
- 3** Click **[DATA GET BY FTP]**.
- 4** Click **[FTP DATA GET FROM SD CARD & USB MEMORY]**.

A list of folders on the SD Memory Drive and USB Drive connected to the instrument will be displayed.

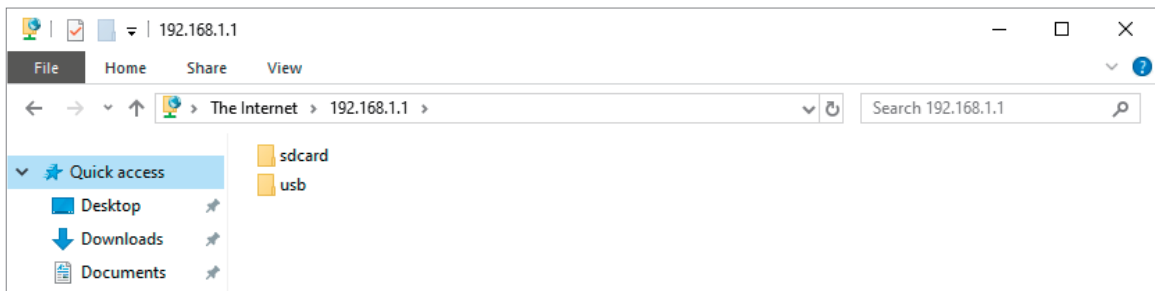

5 Click the type of data you wish to download.



sdcard	SD Memory Card
usb	USB Drive

The folder will open.

6 Right-click a filename and click [Copy To Folder].

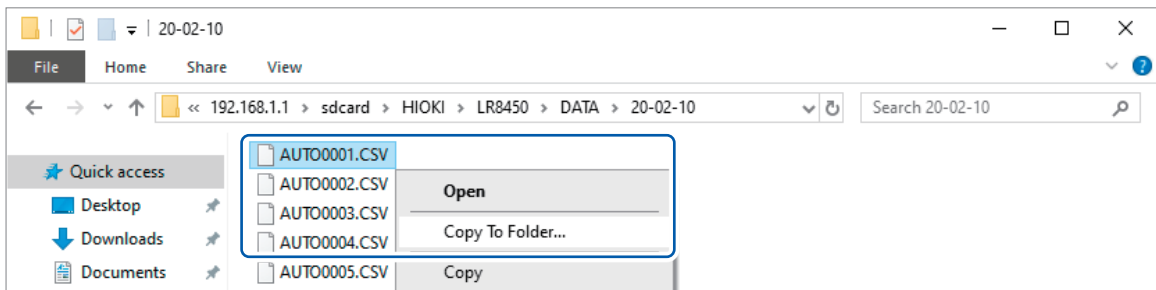

The file will be copied.

IMPORTANT

Depending on the computer's FTP client and browser, some software may delete a file or folder that is being moved if the operation is canceled while still in progress. Exercise care when moving files and folders.

It is recommended to copy the data and then delete the file or folder in question, instead of moving it.

- If **[ON]** is selected under the instrument's **[FTP/HTTP authentication settings]** setting, enter a username and password to log in.
Set a username and password to prevent files from being inadvertently deleted by other users. See "FTP server connection limitations (FTP authentication)" (p.208).
- If connection limits have been set to **[OFF]** under the instrument's **[FTP/HTTP authentication settings]** setting, you cannot perform any file operation (including deletion of files) but file download.
- The instrument's FTP server only supports one connection. You cannot access it from multiple computers at the same time.
- The FTP connection will be closed if no commands are sent for one minute or more. If this happens, open a new FTP connection.
- You may be unable to open a new FTP connection immediately after an FTP connection is closed. If this happens, wait about one minute and then open a new connection.
- Close the FTP connection when switching the SD Memory Card or USB Drive.
- You can externally access the instrument's SD Memory Card or USB Drive using the FTP function. Do not attempt to manipulate files simultaneously using FTP and the instrument. Doing so may result in unintended operation.
- File modification times and dates shown in Internet Explorer® may not match those shown on the instrument.

- Internet Explorer® may not acquire the most recent data if older data from the last access has been stored in temporary Internet files. If the instrument's data has been updated, use FTP after relaunching Internet Explorer®. (Shareware software such as FFFTP may be used instead of Internet Explorer®.)
- The instrument may not be able to access FTP depending on the type and version of an HTTP browser. In this case, use another FTP client program, such as FFFTP.

FTP server connection limitations (FTP authentication)

This section describes how to impose limitations on FTP/HTTP server connections.

Ordinarily, all devices on the network can access the instrument's FTP server because it uses anonymous authentication.

To restrict connections to the FTP server, set **[FTP/HTTP authentication settings]** to **[ON]** and set a username and password.

It is recommended to set a username and password to prevent files from being inadvertently deleted by other users.

SET > **System** > **Comm**

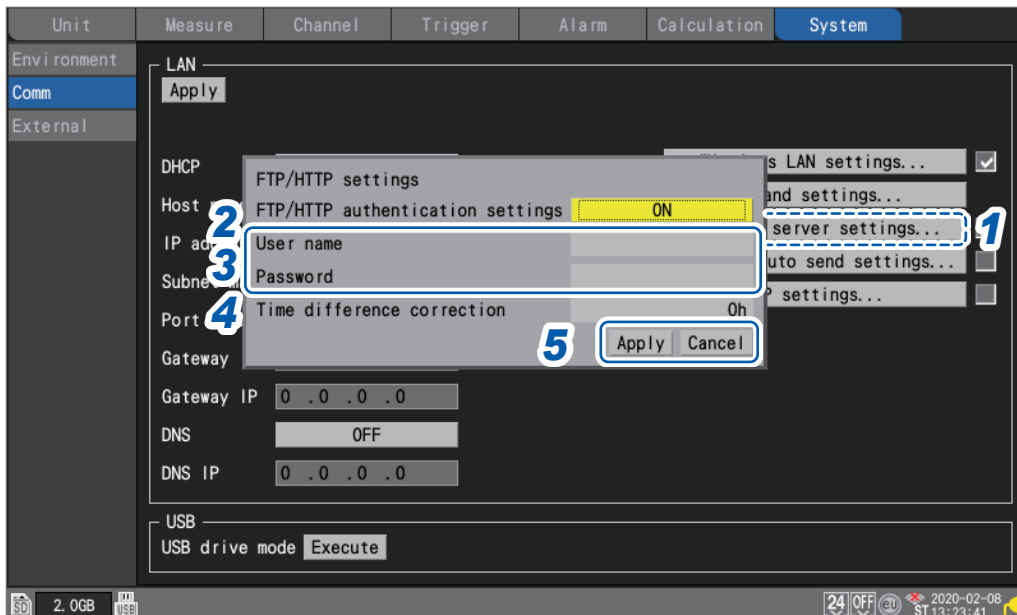

1 Press the **ENTER** key while **[FTP/HTTP server settings...]** is selected.

The settings window will open.

2 Under **[FTP/HTTP authentication settings]**, select whether to restrict FTP/HTTP connections.

OFF , **ON**

3 (When **[FTP/HTTP authentication settings]** is set to **[ON]**)

Configure the following settings:

See “Text entry method” (p.8).

- **[User name]**

Username used when connecting to the instrument from an FTP client or HTTP user agent

String of up to 12 single-byte characters

- **[Password]**

Password used when connecting to the instrument from an FTP client or HTTP user agent

String of up to 12 single-byte characters

The password will be displayed as [●●●●●].

4 Under **[Time difference correction]**, select the difference between the computer’s time and instrument’s time.

-12 h to 12 h; Default setting: 0 h

5 Press the **ENTER** key while **[Apply]** is selected.

The entered settings will be applied, and the settings window will close.

Press the **ENTER** key while **[Cancel]** is selected to close the window without changing any settings.

9.7 Sending Data Using the FTP Client

This section describes how to send files saved automatically on instrument media (SD Memory Card and USB Drive) to an FTP server on a computer.

To do so, specify the IP address of a computer on which an FTP server is running.

You'll need to register the instrument's username and password with the FTP server. For more information, see the Windows® FTP server's help file.

You can use the Windows® FTP server or another server.

Apart from the Windows® FTP server, you can use shareware such as FileZilla Server. Windows 10 Home Edition does not include an FTP server. If you're using Windows 10, use other software such as FileZilla server.

- Under **[Format]** in the **[Waveform data]** area, set the auto saving type to **[Binary]** or **[Text]**.
- Under **[Format]** in the **[Numerical calculation results]** area, set the auto saving type to **[Text]**.
- To send data at a regular interval, set the segmentation method to **[Enable]** under the auto saving **[File splitting]** setting.
- To continue sending data even if the SD Memory Card runs out of space, set the processing method to use when the media runs out of space to **[ON]** under **[Deleting]**.

See "Auto save (real-time save)" (p. 106).

1 Configure the LAN settings and establish a LAN connection. (p.189)

2 Configure the FTP server on the computer. (p.211)

3 Enable automatic sending of files via FTP on the instrument. (p.225)

4 Configure auto saving on the instrument. (p.106)

5 Start measurement on the instrument.

When data is automatically saved by the instrument, the file will be automatically sent to the computer's FTP server.

6 Check the communications. (p.228)

Example computer FTP server settings

Settings vary with the operating system and software being used. Consult the FTP server's help file and your network administrator.

Enabling FTP (Windows 7)

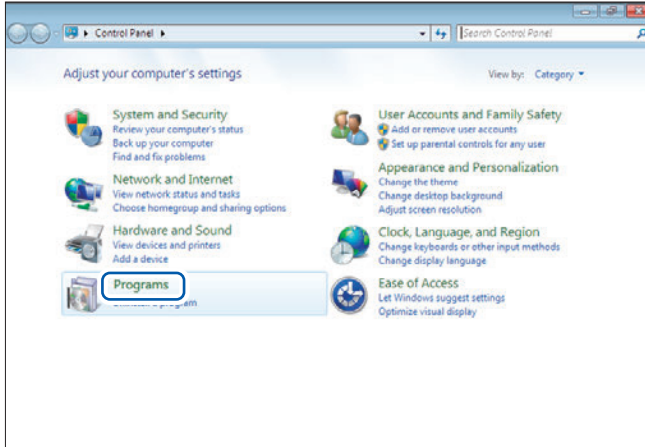

1 Click **[Control Panel]** > **[Programs]**.

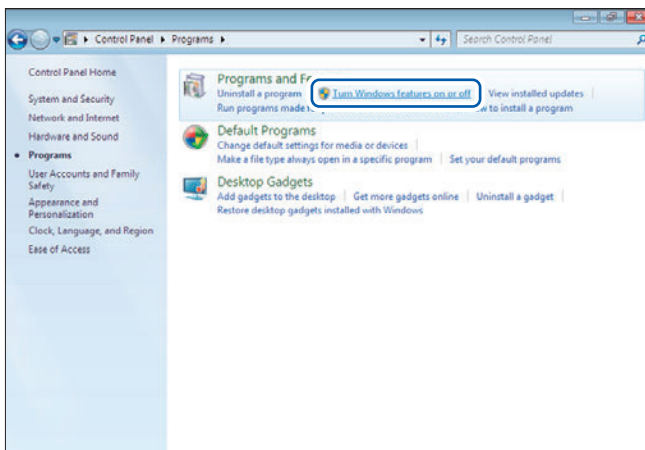

2 Click **[Turn Windows features on or off]**.

The **[Windows Features]** dialog box will be displayed.

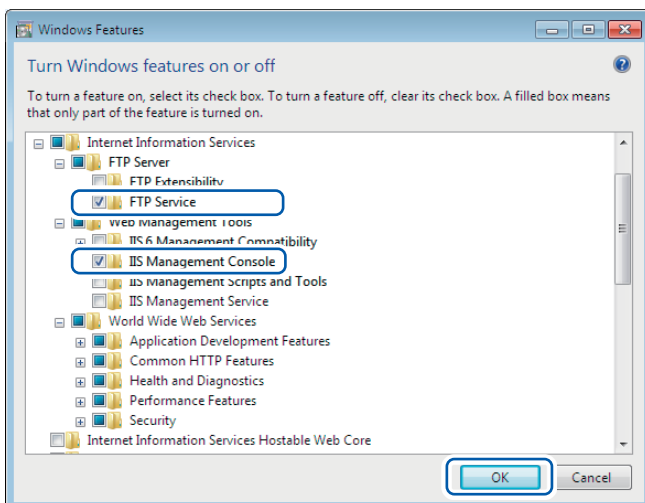

3 Click **[+]** on the left side of **[Internet Information Services]** to expand the view.

Click **[+]** on the left side of **[FTP Server]** to expand the view and select **[FTP Service]**.

Click **[+]** on the left side of **[Web Management Tools]** to expand the view and select **[IIS Management Console]**.

Click **[OK]**.

This completes the FTP installation process.

Once the server has been installed, a folder named **[inetpub]** will be created in drive C's root folder.

Configuring FTP (Windows 7)

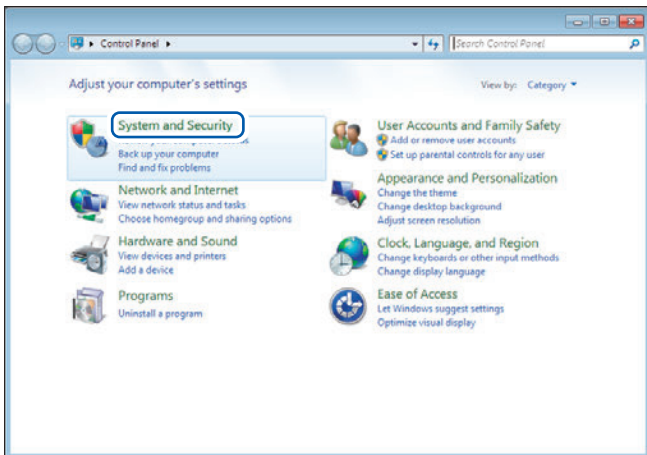

1 Click [Control Panel] > [System and Security].

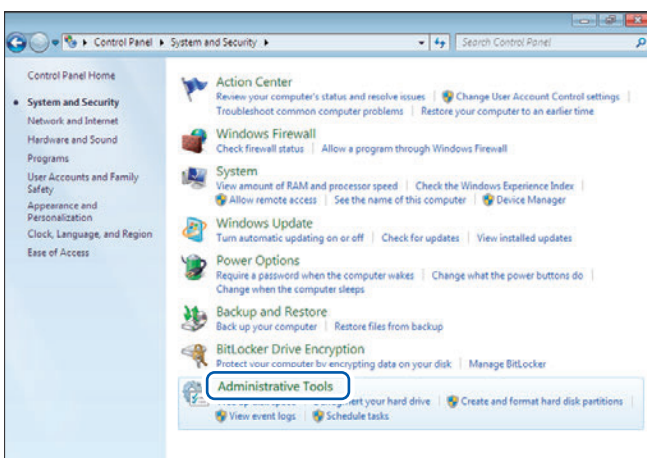

2 Click [Administrative Tools].

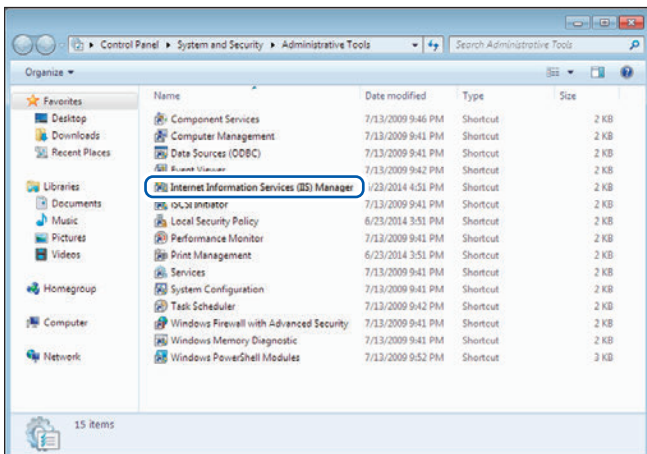

3 Double-click [Internet Information Services (IIS) Manager].

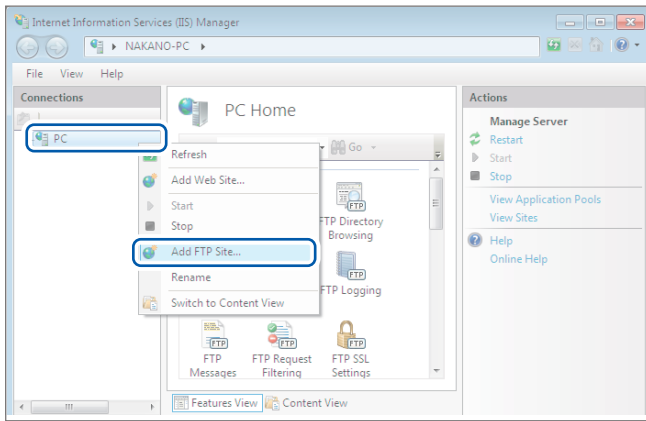

4 Right-click the item displayed under **[Connections]** on the left pane and click **[Add FTP Site...]** on the shortcut menu.

Communications may be blocked depending on how any security software (for example, a firewall) has been configured.

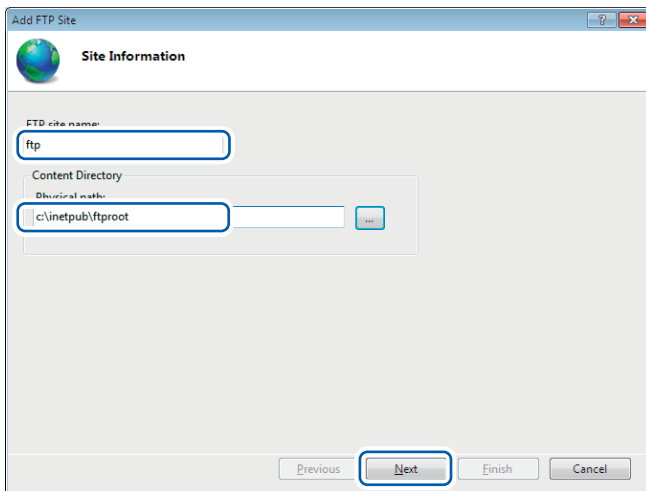

5 Enter the **[FTP site name]**.
Example: ftp

In **[Physical path]** under **[Content Directory]**, specify the location where data from FTP clients should be saved.
Example: C:\inetpub\ftproot

Click **[Next]**.

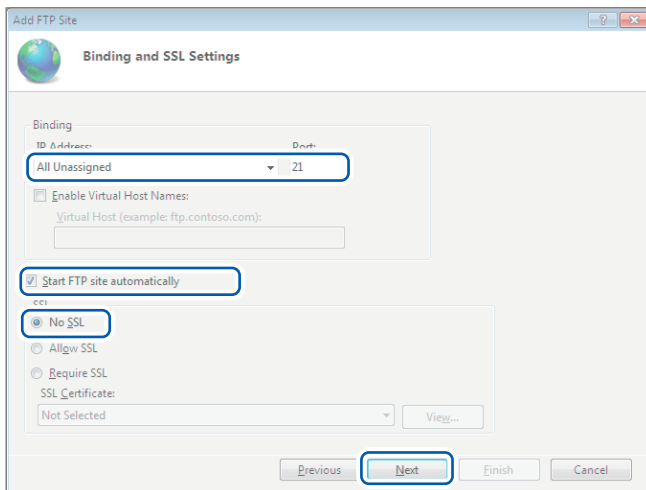

6 Set **[Binding]** and **[SSL]** as follows:

[IP Address]	[All Unassigned]
[Port]	[21]
[Start FTP site automatically]	Select.
[SSL]	[No_SSL]

Click **[Next]**.

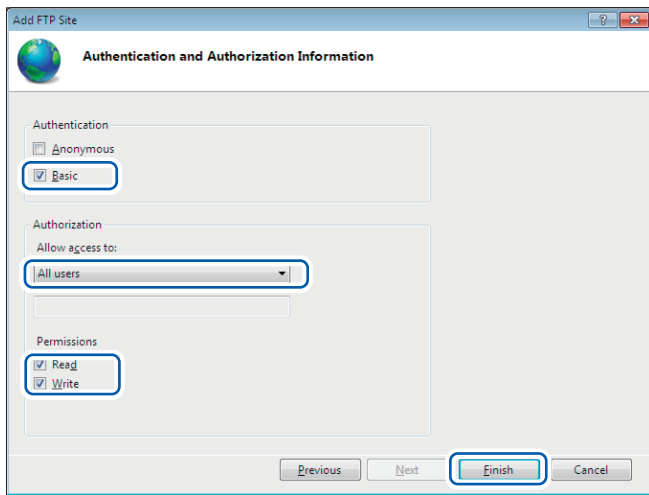

7 Set [Authentication and Authorization Information] as follows:

[Authentication]	Select [Basic].
[Authorization]	[All users]
[Permissions]	Select both [Read] and [Write].

Click [Finish].

Enabling FTP traffic with the firewall (Windows 7)

1 Click [Control Panel] > [System and Security].

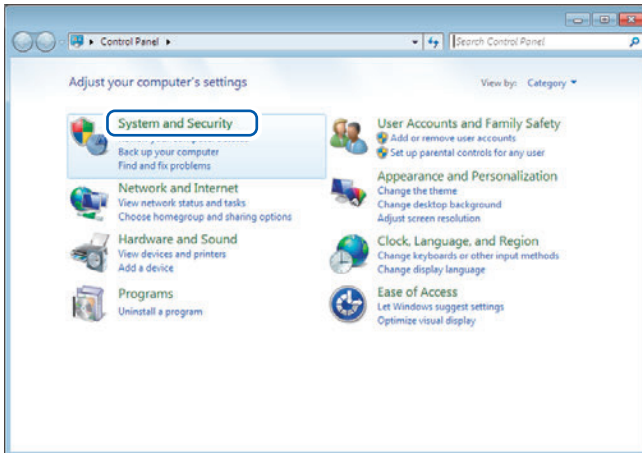

2 Click [Windows Firewall].

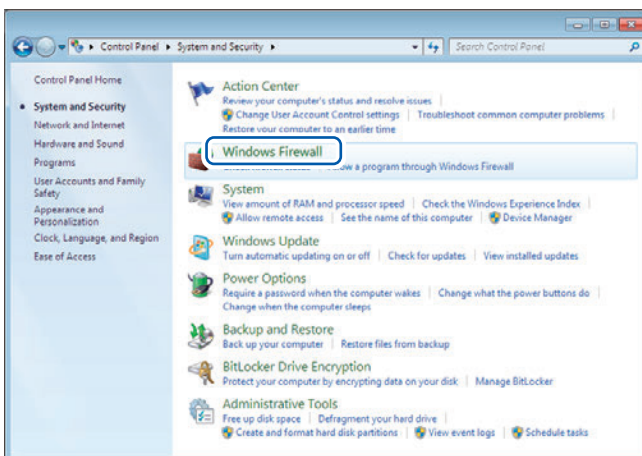

3 Click [Advanced settings].

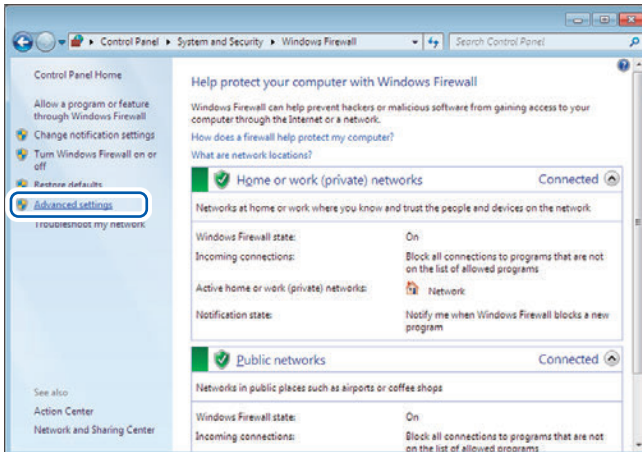

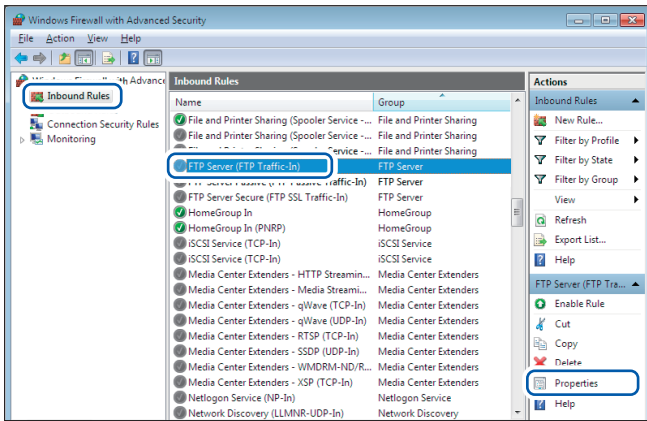

4 Click [Inbound Rules] on the left pane, right-click [FTP server (FTP Traffic-In)], and click [Properties] in the shortcut menu.

The [FTP Server (FTP Traffic-In) Properties] dialog box will be displayed.

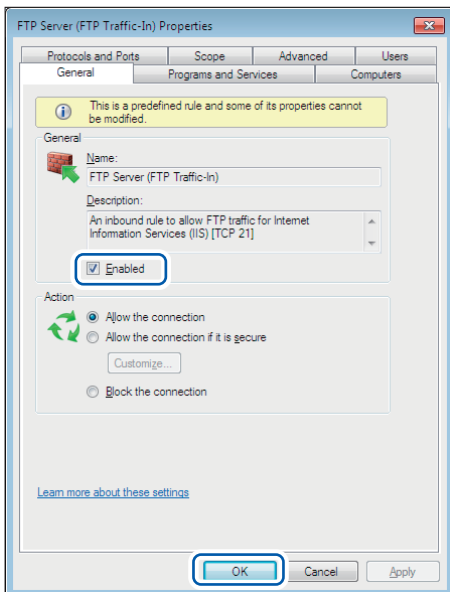

5 Select [Enables] on the [General] tab and then click [OK].

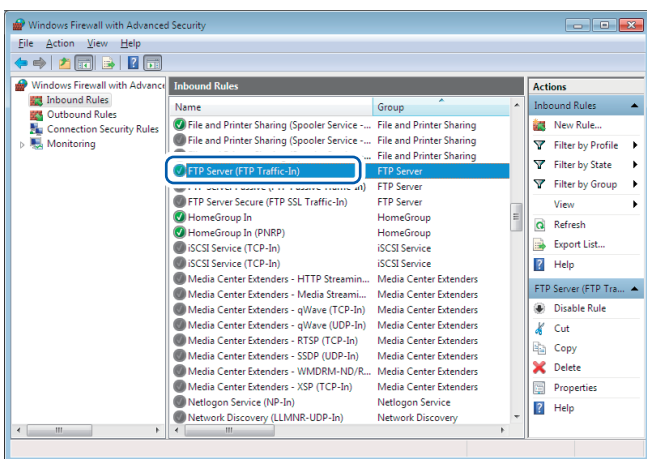

6 Verify that [FTP Server (FTP Traffic-In)] is enabled and click [X] (the [Close] button).

Configuring accessing users (Windows 7)

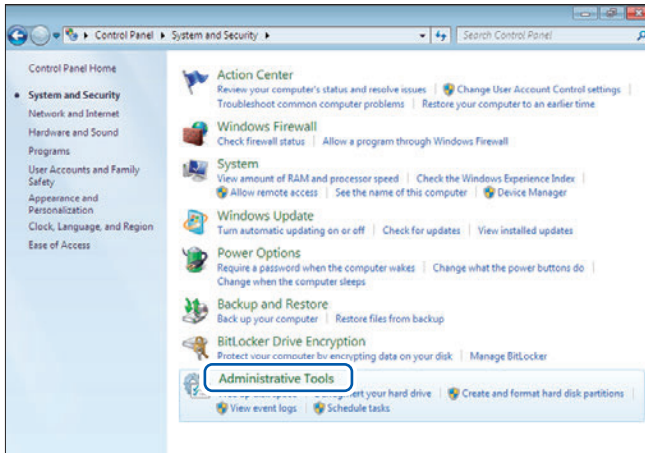

1 Click [Control Panel] > [System and Security] > [Administrative Tools].

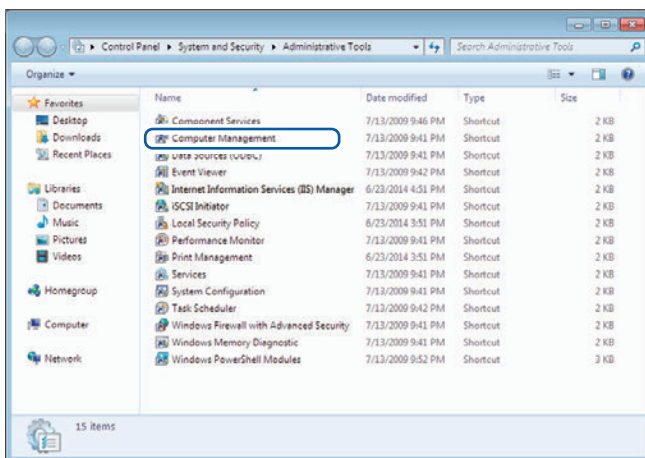

2 Double-click [Computer Management].

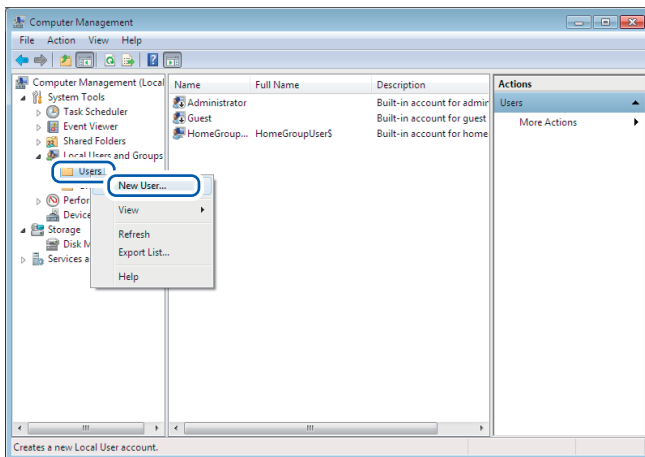

3 Right-click [Users] under [Local Users and Groups] and select [New User...] from the shortcut menu.

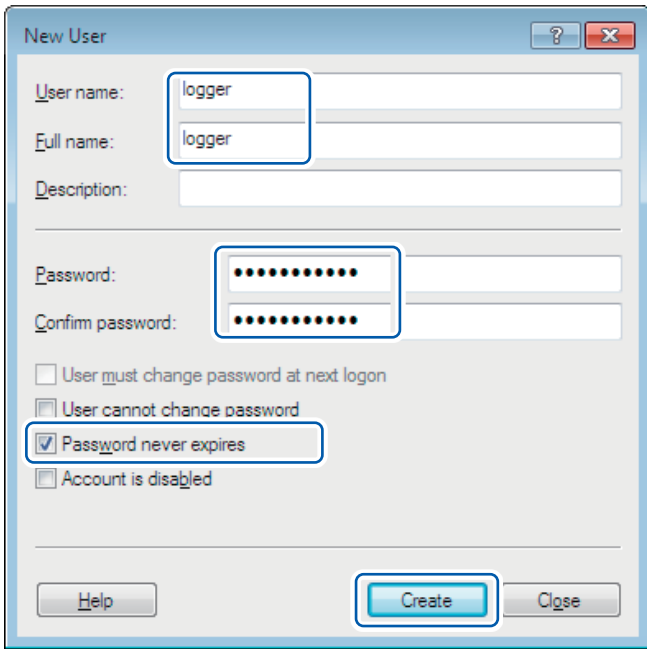

4 Enter the username in the [User name] and [Full name] fields and the password in the [Password] and [Confirm password] fields.

Select the [Password never expires] checkbox.

Click [Create].

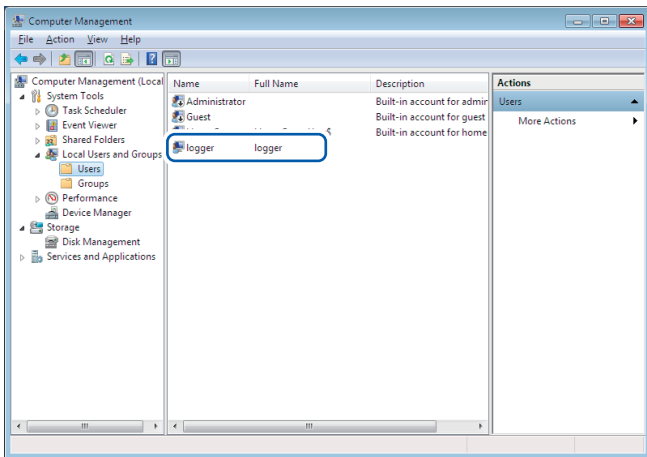

5 Verify that the set username has been registered and click [x] (the [Close] button).

Enabling access to the FTP folder (Windows 7)

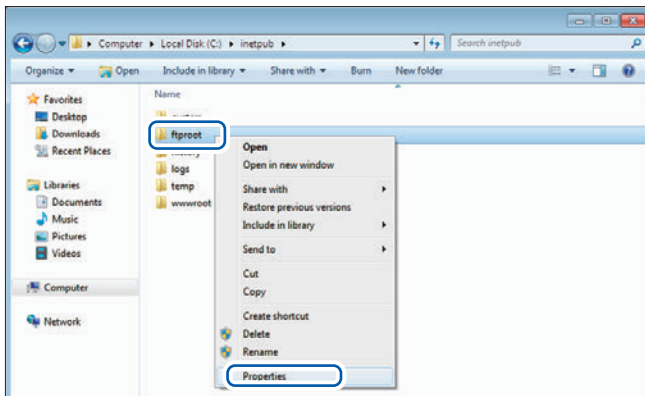

- 1 Right-click the folder specified in **[Physical path]** under **[Content Directory]** in the FTP site settings and select **[Properties]**.

Example: C:\inetpub\ftproot

The **[ftproot Properties]** dialog box will open.

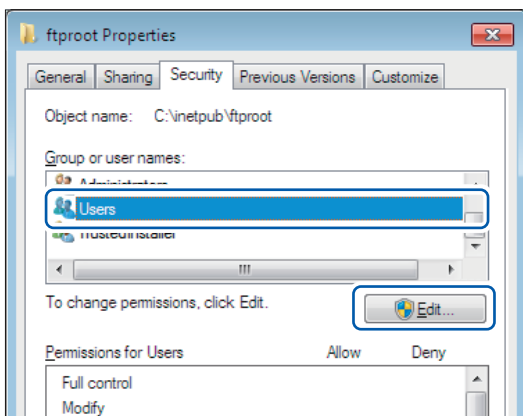

- 2 Select **[Users]** under **[Group or user names]** on the **[Security]** tab and click **[Edit]**.

The **[Permissions for ftproot]** dialog box will open.

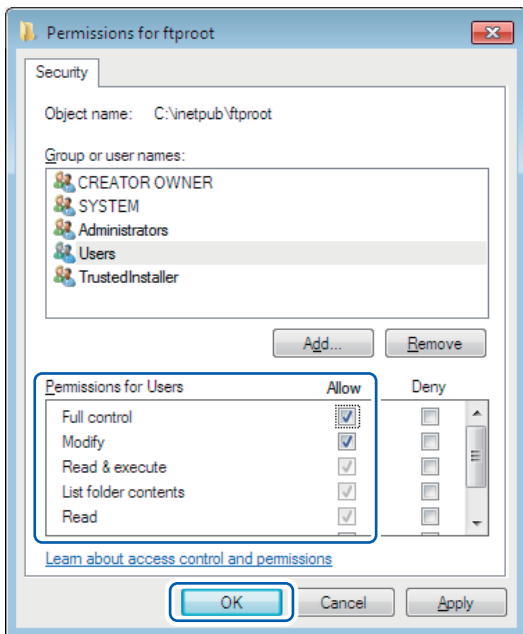

- 3 Select **[Allow]** for **[Full control]** under **[Permissions for Users]** and click **[OK]**.

The **[Permissions for ftproot]** dialog box will close.

- 4 Click **[OK]**.

The **[ftproot Properties]** dialog box will close.

Restarting the FTP server

Restart Microsoft® FTP Service under **[Control Panel] > [System and Security] > [Administrative Tools] > [Services]**.

This completes the FTP configuration process for Windows 7.

Enabling FTP (Windows 10)

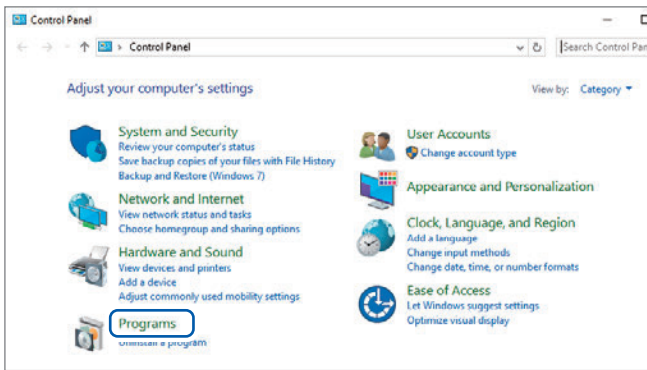

1 Click **[Control Panel]** > **[Programs]**.

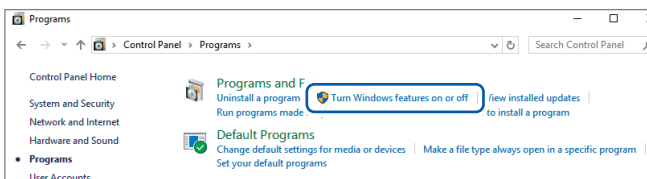

2 Click **[Turn Windows features on or off]**.

The **[Windows Features]** dialog box will be displayed.

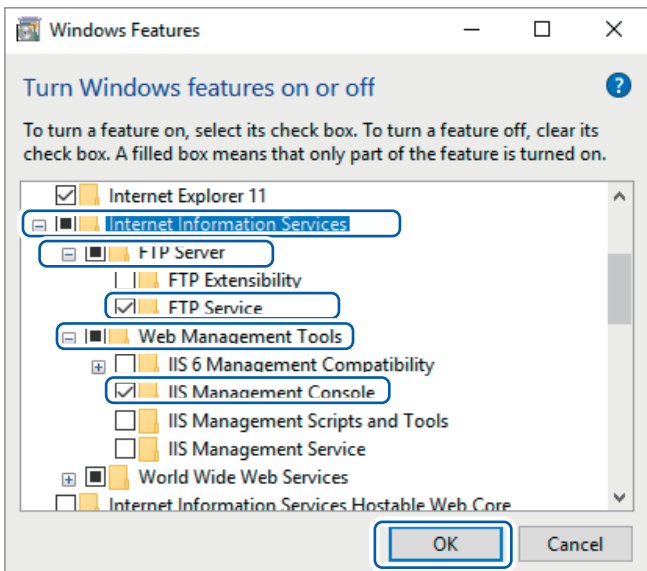

3 Click **[+]** on the left side of **[Internet Information Services]** to expand the view.

Click **[+]** on the left side of **[FTP Server]** to expand the view and select **[FTP Service]**.

Click **[+]** on the left side of **[Web Management Tools]** to expand the view and select **[IIS Management Console]**.

Click **[OK]**.

This completes the FTP installation process.

Once the server has been installed, a folder named **[inetpub]** will be created in drive C's root folder.

Configuring FTP (Windows 10)

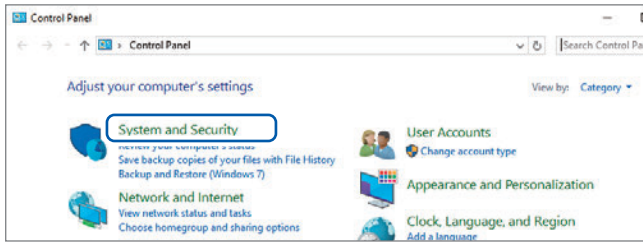

1 Click **[System and Security]** under **[Control Panel]**.

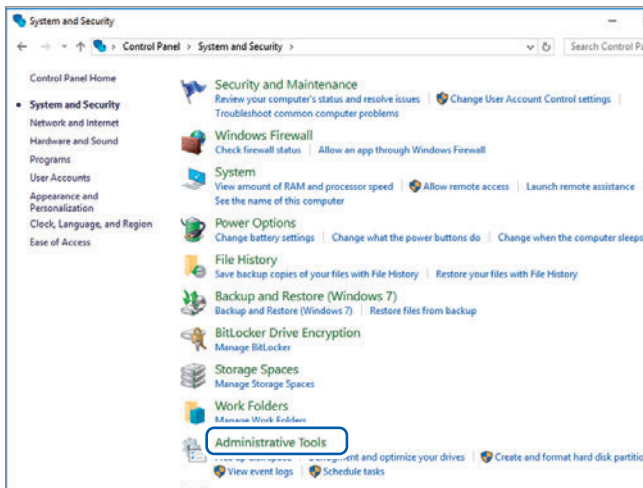

2 Click **[Administrative Tools]**.

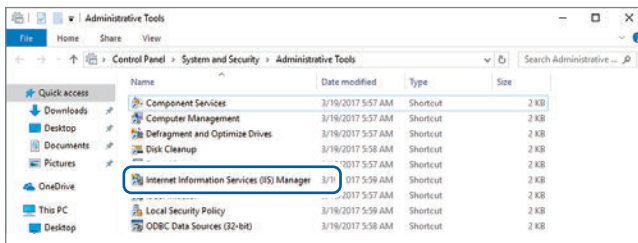

3 Double-click **[Internet Information Services (IIS) Manager]**.

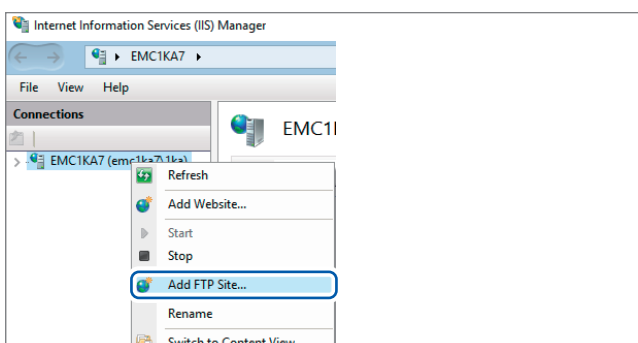

4 Right-click the item displayed under **[Connections]** on the left side of the screen and click **[Add FTP Site...]** on the shortcut menu.

Communications may be blocked depending on how any security software (for example, a firewall) has been configured.

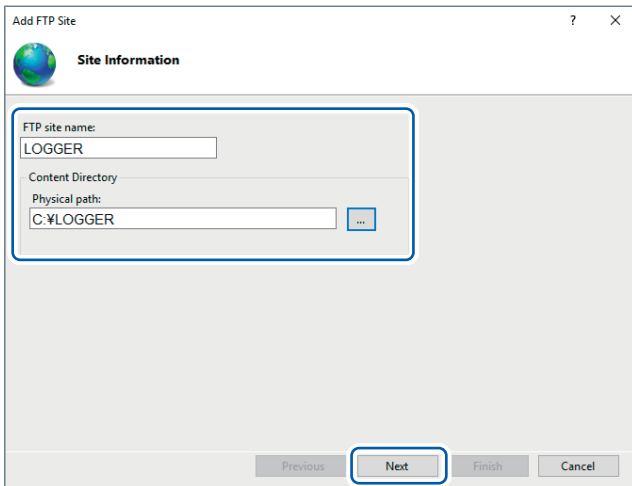

5 Enter **[Site Information]**.

Example:

[FTP site name]: **LOGGER**
In [Physical path] under [Content Directory], specify the location where data from FTP clients should be saved.

Click **[Next]**.

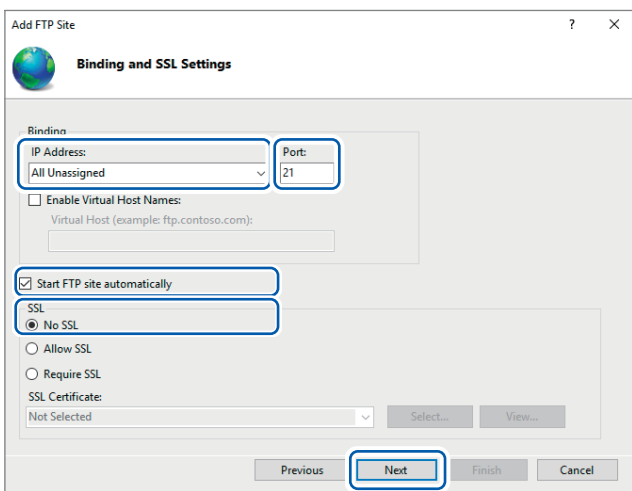

6 Set **[Binding]** and **[SSL]** as follows:

[IP Address]	[All Unassigned]
[Port]	[21]
[Start FTP site automatically]	Select.
[SSL]	[No SSL]

Click **[Next]**.

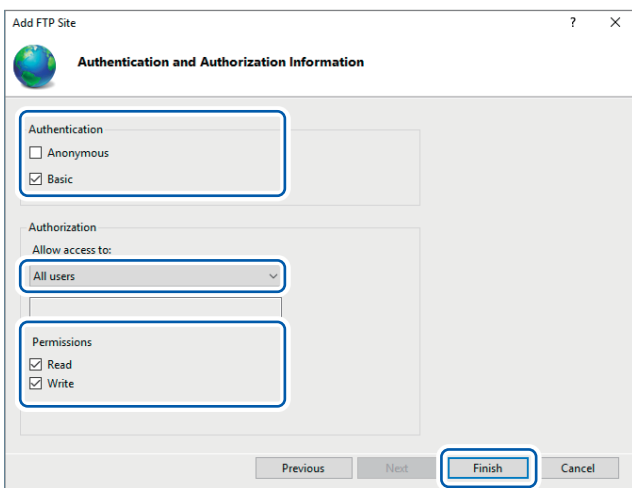

7 Set **[Authentication and Authorization Information]** as follows:

[Authentication]	Select [Basic] .
[Authorization]	[All users]
[Permissions]	Select both [Read] and [Write] .

Click **[Finish]**.

Configuring accessing users (Windows 10)

Enter the username and password for using FTP.

Enter the username and password set here in the **[User name]** and **[Password]** fields on the instrument's FTP client settings screen. (See "2 Configure the settings." [p.226].)

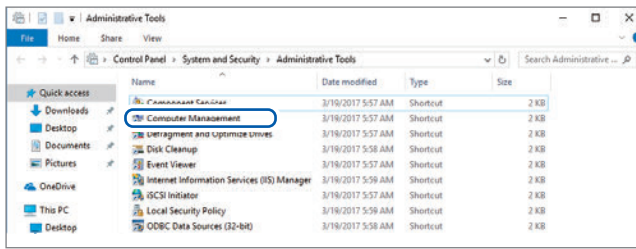

- 1 Select **[Computer Management]** from **[Administrative Tools]** in Step 5 (p.221).

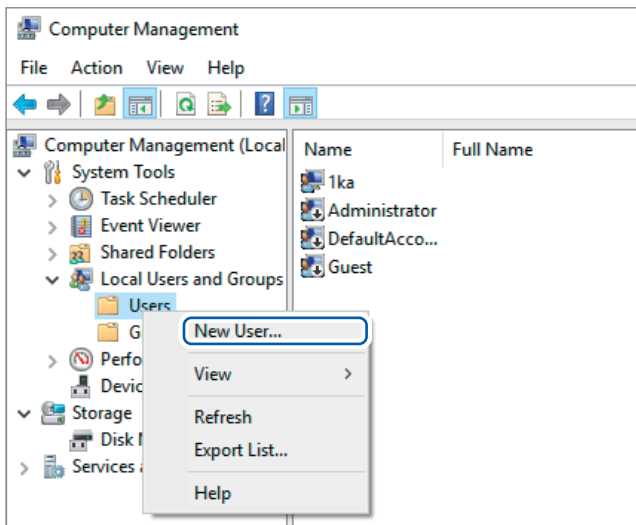

- 2 Right-click **[Users]** under **[Local Users and Groups]** and select **[New User...]** from the shortcut menu.

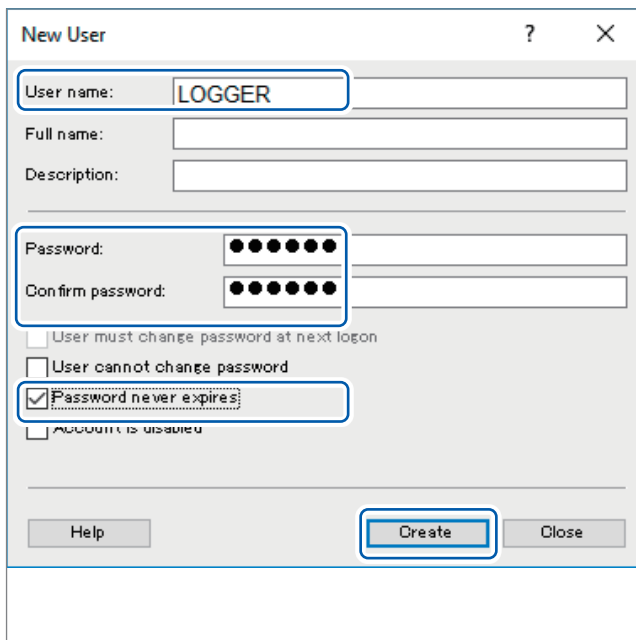

- 3 Enter the username in the **[User name]** field and the password in the **[Password]** and **[Confirm password]** fields and select the **[Password never expires]** checkbox.

Click **[Create]**.

Configuring the firewall (Windows 10)

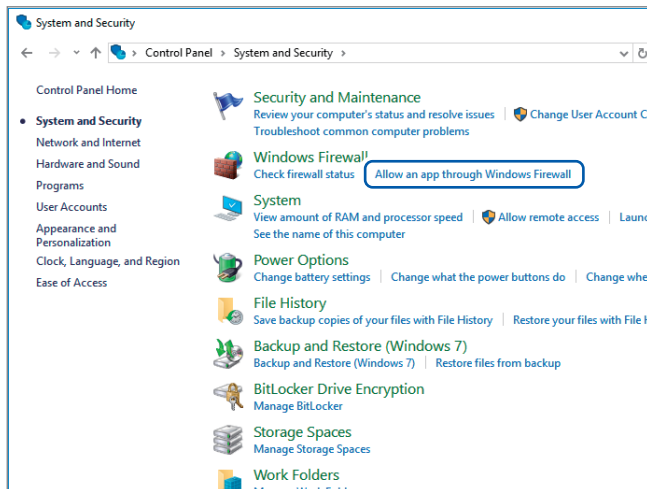

4 Click **[Allow an app through Windows Firewall]** under **[System and Security]** in step **1** (p.221).

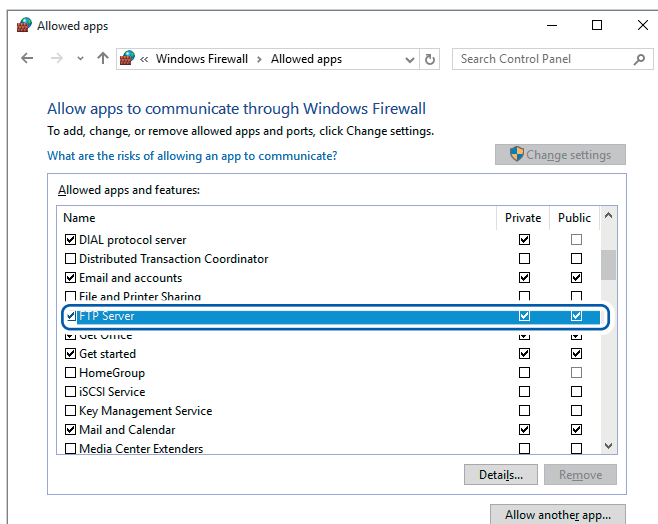

5 Select **[FTP Server]**.
Select whether you are using a private or public connection to the instrument.

Restarting the FTP server

Restart Microsoft® FTP Service under **[Control Panel] > [System and Security] > [Administrative Tools] > [Service]**.

This completes the FTP configuration process for Windows 10.

Configuring automatic sending of data

This section describes how to send files saved automatically on instrument media to an FTP server on a computer.

Instructions

This examples describes how to send data to an FTP server with the IP address 192.168.1.1.

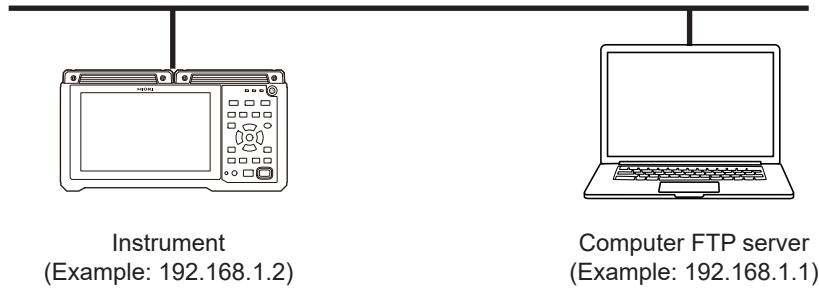

SET > **System** > **Comm**

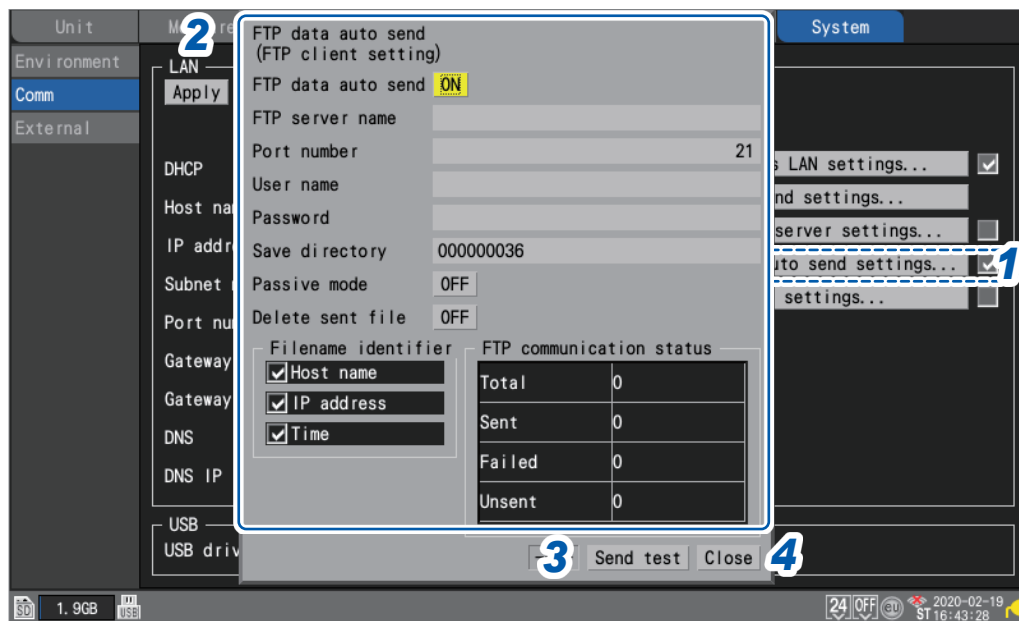

- 1** Press the **ENTER** key while **[FTP data auto send settings...]** is selected. The settings window will open.

2 Configure the settings.

- Under **[FTP data auto send]**, set the function to **[ON]**.
- **[FTP server name]**
Set the hostname or IP address of the FTP server.
See “Configuring the computer’s network settings” (p. 191).

String of up to 32 single-byte characters (examples: **LOGGER**, **192.168.1.1**)

- **[Port number]**
Set the FTP server’s port number.

1 to **65535**; Default setting: **21**

- **[User name]**
Set the username to use when logging in to the FTP server.
Set to the instrument’s username that was registered with the computer’s FTP server.

String of up to 32 single-byte characters (example: **LOGGER**)

- **[Password]**
Set the password to use when logging in to the FTP server.
Set to the instrument’s password that was registered with the computer’s FTP server.

String of up to 32 single-byte characters (example: **LOGGER**)

The password will be displayed as **[•••••]**.

- **[Save directory]**
Specify the directory on the FTP server in which to save data.
(Default setting: serial number of the instrument)

String of up to 32 single-byte characters (example: **data**)

- **[Passive mode]**
Select whether to use PASV mode when sending data.

OFF , **ON**

- **[Delete sent file]**

OFF , **ON**

- **[Filename identifier]**
Select the identifier(s) to add to filenames by selecting the desired checkbox(es).

Host name, IP address, Time

Example:

Hostname	LOGGER
Port number	21
Time	'20-01-10 08:30:05
Auto save filename	AUTO0001.MEM

According to the above settings, the filename when the **[Host name]**, **[IP address]**, and **[Time]** checkboxes have all been selected will be **[LOGGER_192-168-1-2_200110-083005_AUTO0001.MEM]**. This functionality helps identify files when using multiple loggers.

3 Once you’re finished configuring the FTP settings, send a test file.

See “Sending a test file” (p.227).

4 Press the **ENTER** key while **[Close]** is selected.

The settings window will close.



Sending a test file

This section describes how to check whether the instrument can send a file using FTP.

SET > **System** > **Comm**

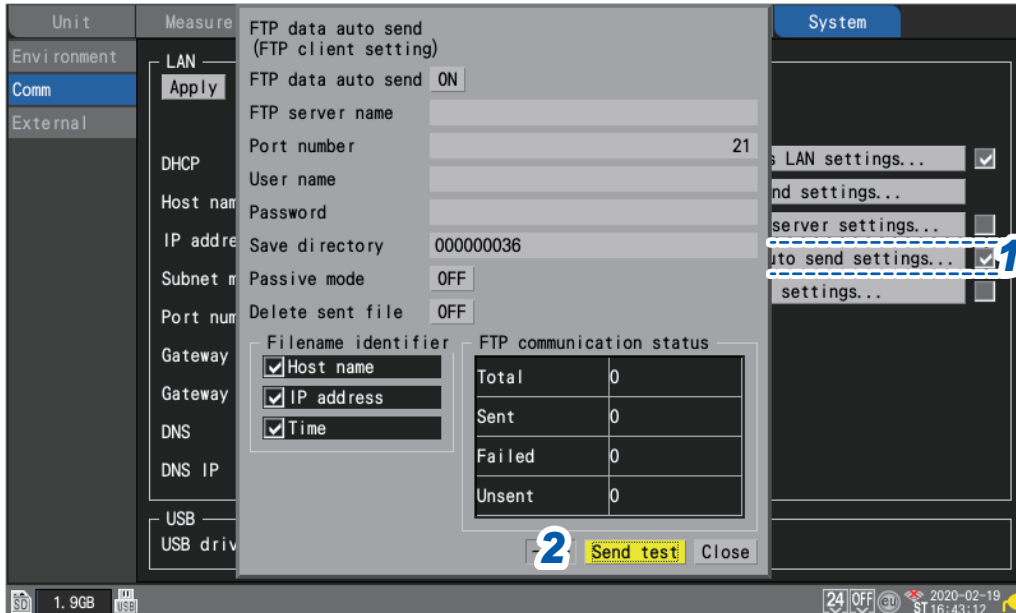

- 1** Press the **ENTER** key while **[FTP data auto send settings...]** is selected.
The settings window will open.
The identifiers whose checkboxes are selected under **[Filename identifier]** will be added to the filename.
- 2** Press the **ENTER** key while **[Send test]** is selected.
The test file **[FTP_TEST.TXT]** will be sent to **[C:\Intpublftproof]**.

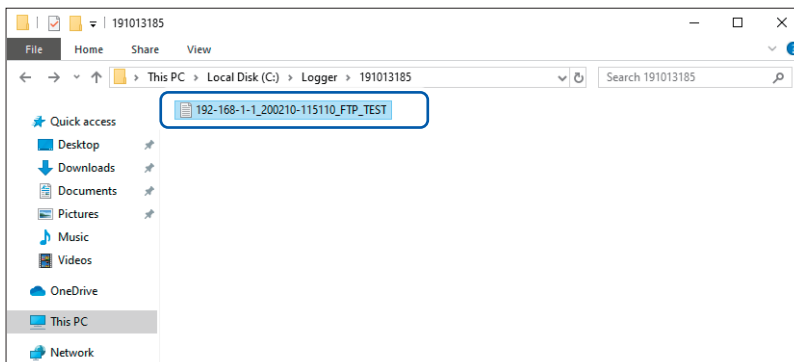

If you are unable to send the test file, check the instrument's automatic send settings and the computer's FTP settings.
If you find no issues when sending the test file, start measurement.
Measured waveform data will be automatically sent to the computer's FTP server.

Data transmission times

Transfer time (s) = File size (KB) / transfer speed (KB/s) + transfer preparation time (s)

For more information about file sizes, see “11.8 File Size” (p.289).

Use 4 MB/s as a rough transfer speed and 3 s as a rough transfer preparation time.

Example: For a 40 MB file

$$\text{Transfer time} = 40 \text{ MB} / 4 \text{ (MB/s)} + 3 \text{ (s)} = 10 + 3 \text{ (s)} = 13 \text{ (s)}$$

Checking FTP communications status

This section describes how to check the FTP communications status.

You can display the number of files sent by FTP, the number of transmission errors, and other statistics.

SET > **System** > **Comm**

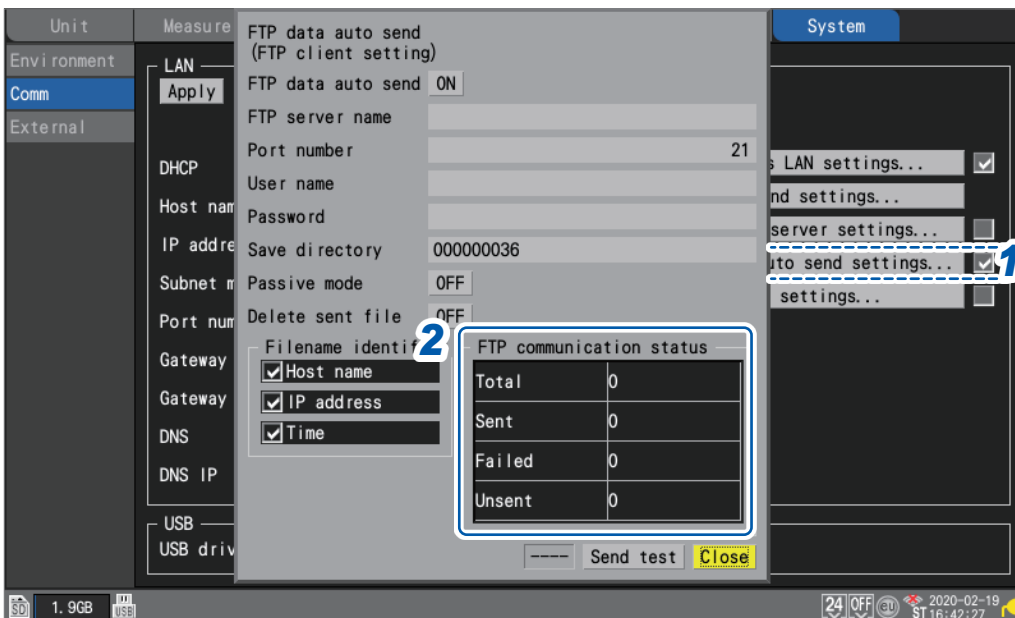

- 1 Press the **ENTER** key while **[FTP data auto send settings...]** is selected.

The settings window will open.

- 2 Under **[FTP communication status]**, check the file counters.

Total, Sent, Failed, Unsent

The counters will be reset to 0 under the following circumstances:

- When measurement is started by pressing the **START** key
- When the LAN settings are changed
- When the wireless LAN settings are changed
- When the FTP client settings are changed

9.8 Controlling the Instrument with Communication Commands

This section describes how to control and communicate with the instrument by sending communication commands from a computer.

The instrument and computer must be connected using either a USB cable or a LAN cable.

See “Connecting the instrument to the computer with a USB cable” (p. 188).

See “Connecting the instrument to a computer with a LAN cable” (p. 196).

The instrument must be configured in order to control it using communication commands.

SET > System > Comm

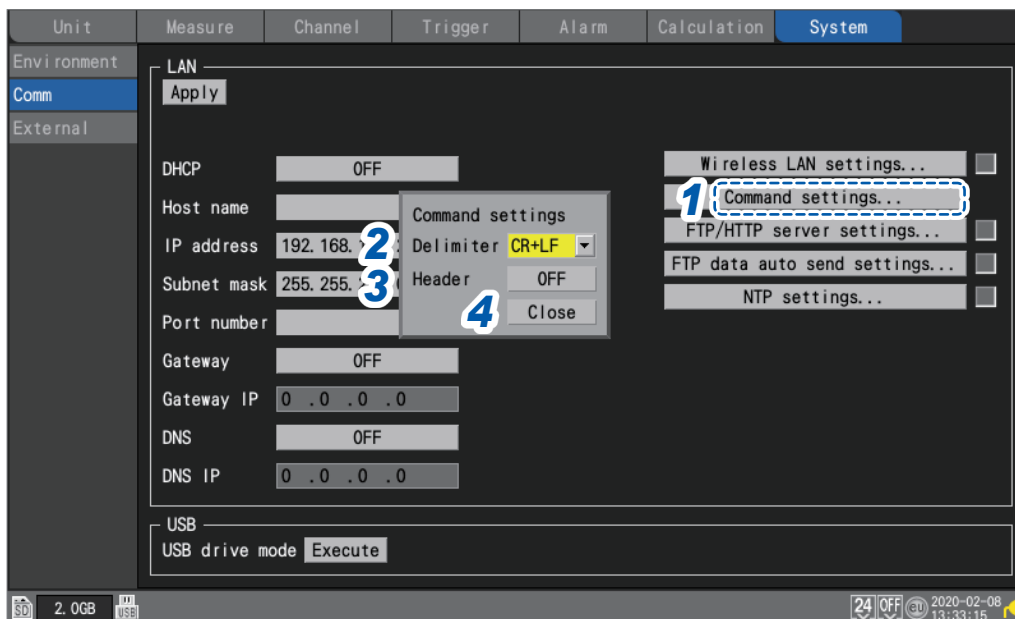

- 1 Press the **ENTER** key while **[Command settings...]** is selected.

The settings window will open.

- 2 Under **[Delimiter]**, select the communication command line feed code.

LF, CR+LF

- 3 Under **[Header]**, select whether to add a header to command responses.

OFF , ON

- 4 Press the **ENTER** key while **[Close]** is selected.

The settings window will close.

For more information about communication commands, see the “Communication Command User Manual” on the included CD.



10 Specifications

10.1 Basic Specifications

LR8450/LR8450-01 Memory HiLogger

1. General specifications

-1. Basic specifications

Product warranty period	3 years
Accuracy guarantee period	1 year
Maximum number of connectable modules	4 plug-in modules + 7 wireless modules* *: LR8450-01 only
Connectable modules (Plug-in modules)	U8550 Voltage/Temp Unit U8551 Universal Unit U8552 Voltage/Temp Unit U8553 High Speed Voltage Unit U8554 Strain Unit
Connectable modules (Wireless modules) (LR8450-01 only)	LR8530 Wireless Voltage/Temp Unit LR8531 Wireless Universal Unit LR8532 Wireless Voltage/Temp Unit LR8533 Wireless High Speed Voltage Unit LR8534 Wireless Strain Unit
Internal buffer memory	Volatile memory, 256 Mwords
Clock functionality	Auto-calendar, automatic leap year recognition, 24-hour clock
Clock precision (Precision of clock displayed by instrument as well as start/stop times)	±1.0 s/day (at 23°C) Time can be synchronized with an NTP server to which instrument is connected.
Time axis accuracy	±0.2 s/day (at 23°C)
Backup battery service life	At least 10 years for clock (reference value at 23°C)
Operating environment	Indoors, Pollution Degree 2, altitude up to 2000 m (6562 ft.)
Operating temperature and humidity range	-10°C to 50°C (14°F to 122°F), 80% RH or less (non-condensing) (Charging temperature range: 5°C to 35°C [41°F to 95°F])
Storage temperature and humidity range	-20°C to 60°C (-4°F to 140°F), 80% RH or less (non-condensing)
Dimensions	Without any modules: 272W × 145H × 43D mm (10.72"W × 5.71"H × 1.69"D) (excluding protrusions) With 2 modules: 272W × 198H × 63D mm (10.71"W × 7.8"H × 2.78"D) (excluding protrusions) With 4 modules: 272W × 252H × 63D mm (10.71"W × 9.92"H × 2.48"D) (excluding protruding parts)
Mass	Approx. 1.1 kg (38.8 oz.)
Standards	Safety EN61010 EMC EN61326 Class A

Vibration resistance	JIS D 1601:1995 5.3 (1) Class 1: Passenger vehicles; conditions: Class A equivalent (4 h along X-axis and 2 h along Y- and Z-axes at a vibration acceleration of 45 m/s ² [4.6 G])	
-2. Display		
Display	7-inch TFT color LCD (WVGA 800 × 480 dots)	
Display resolution (with waveform display selected)	Max. 20 divisions (horizontal axis) × 10 divisions (vertical axis) (1 division = 36 dots [horizontal axis] × 36 dots [vertical axis])	
Display language	Japanese and English	
Backlight service life	Approx. 100,000 h (reference value at 23°C)	
Backlight saver	Turns off backlight when no key is operated for a set amount of time. (Choose from Off, 30 s, 1 min., 2 min., 5 min., 10 min.)	
Backlight brightness	5 levels (user-selectable)	
Waveform background color	Dark/light (user-selectable)	
-3. Power supply		
Power supply	AC adapter	Z1014 AC Adapter (12 V DC ±10%) AC Adapter rated supply voltage 100 V to 240 V AC (assuming voltage fluctuation of ±10%) AC Adapter rated power supply frequency 50 Hz/60 Hz
	Battery	LR8450 accommodates 2 batteries. Z1007 Battery Pack (When used with AC Adapter, AC Adapter has priority.) Li-ion, 7.2 V, 2170 mAh
	External power supply	10 V to 30 V DC
Power consumption	Normal power consumption	Using Z1014 AC Adapter or 12 V DC external power supply, without Battery Pack With LCD at maximum brightness: 8.5 VA (instrument only) With LCD backlight off: 7 VA (instrument only)
	Maximum rated power	When using the Z1014 AC Adapter 95 VA (including AC Adapter) When using a 30 V DC external power supply 28 VA (while charging battery with LCD at maximum brightness) When using the Z1007 Battery Pack 20 VA (with LCD at maximum brightness)
Continuous operating time	Battery	With one Z1007 Battery Pack: Approx. 2 h (reference value at 23°C) With two Z1007 Battery Packs: Approx. 4 h (reference value at 23°C) Conditions: With one U8551 Universal Unit connected, backlight on, voltage output off, and Z4006 connected
Charging functionality	Charging is available when the Z1007 Battery Pack is attached and the AC Adapter is connected. Charging time: Approx. 7 h (reference value at 23°C)	

-4. Interface specifications

The LAN interface and USB interface (function) cannot be used at the same time.

LAN interface	LAN	IEEE 802.3 Ethernet, automatic 100Base-TX/1000Base-T detection Auto MDI-X, DHCP, DNS support
	Connector	RJ-45
	Maximum cable length	100 m
	LAN functionality	Configuring settings and controlling recording using communications commands Manually acquiring data using the FTP server Acquiring files from a connected SD Memory Card or USB Drive Automatically sending data via FTP (FTP client) Transferring files saved on a connected SD Memory Card or USB Drive While measurement is in progress: Waveform files (binary, text) After measurement has finished: Waveform files (binary, text) Remote operation using the HTTP server Screen display and remote operation, starting and stopping measurement, acquiring data via FTP, setting comments NTP client function Time synchronization with an NTP server Regular synchronization intervals: 1 h, 1 day Pre-measurement synchronization function
Wireless LAN interface (LR8450-01 only)	Wireless LAN	IEEE 802.11b/g/n Communications range: 30 m, line of sight Encryption function: WPA-PSK/WPA2-PSK, TKIP/AES Usable channels: 1 to 11 Auto-connect function Wireless LAN function can be toggled on and off.
	Supporting mode	Station
	Connectable devices	Computer / tablet computer
	Wireless LAN functionality	Configuring settings and controlling recording using communications commands Manually acquiring data using the FTP server Acquiring files from a connected SD Memory Card or USB Drive Automatically sending data via FTP (FTP client) Transferring files saved on a connected SD Memory Card or USB Drive While measurement is in progress: Waveform files (binary, text) After measurement has finished: Waveform files (binary, text) Remote operation using the HTTP server Screen display and remote operation, starting and stopping measurement, acquiring data via FTP, setting comments NTP client function Time synchronization with an NTP server Regular synchronization intervals: 1 h, 1 day Pre-measurement synchronization function
USB interface (host)	Standard compliance	USB 2.0 compliant
	Connectors	Series A receptacle × 2
	Guaranteed-operation options	Z4006 USB Drive (16 GB) File system: FAT16, FAT32
	Connectable devices	Keyboard, hub (1 layer), USB Drive (1 port only)

USB interface (function)	USB standard	USB 2.0 compliant
	Connector	Series mini-B receptacle
	USB functionality	Configuring settings and controlling recording using communications commands USB drive mode: Transferring data from a connected SD Memory Card to a computer
SD card slot	Standard compliance	SD standard-compliant slot × 1 (with SD Memory Card/SDHC Memory Card support)
	Guaranteed-operation options	Z4001 (2 GB), Z4003 (8 GB) File system: FAT16, FAT32

-5. External control terminals

Terminal block	Push-button type terminal block	
External I/O		
Number of terminals	4	
	Non-isolated (same GND as instrument)	
Input	Input voltage	0 V to 10 V DC High level: 2.5 V to 10 V; low level: 0 V to 0.8 V
	Slope	Rising/falling (user-selectable)
	Response pulse width	High period: 2.5 ms or greater; low period: 2.5 ms or greater
	Functionality	Choose from off, start, stop, start/stop, trigger input, event input.
	Output	Output format
	Output voltage	High level: 4.0 V to 5.0 V; low level: 0 V to 0.5 V High output/low output (user-selectable)
	Maximum switching capacity	5 V to 10 V DC, 200 mA
	Output pulse width (Trigger output)	10 ms or greater
	Functionality	Trigger output
Alarm output	Output format	Open-drain output (with 5 V voltage output)
	Output voltage	High level: 4.0 V to 5.0 V; low level: 0 V to 0.5 V Triggered by alarm High output/low output (user-selectable)
	Maximum switching capacity	5 V to 30 V DC, 200 mA
	Output pulse width	10 ms or greater
	Number of terminals	8 Non-isolated (same GND as instrument)
Voltage output	Output voltage	Off, 5 V ±10%, 12 V ±10%, 24 V* ±10% (user-selectable) Supply current: Max. 100 mA each *: 24 V output can be selected for the VOUTPUT1 terminal only.
	Number of terminals	2 Non-isolated (same GND as instrument)
GND terminal	Number of terminals	10 (common GND)

2. Recording

Recording mode	Normal	
Recording intervals	1 ms*, 2 ms*, 5 ms*, 10 ms, 20 ms, 50 ms, 100 ms, 200 ms, 500 ms, 1 s, 2 s, 5 s, 10 s, 20 s, 30 s, 1 min., 2 min., 5 min., 10 min., 20 min., 30 min., 1 h *: Setting available only when using a module with data refresh intervals including 1 ms.	
Data refresh interval	Automatically- or user-selected value per module Automatically-selected value: The optimal data refresh interval is automatically selected based on the recording interval setting. User-selected value: Available settings depend on module specifications.	
Repeat recording	Off/On (user-selectable) On: Recording resumes after recording stops (due to stop trigger conditions or the completion of measurement for the set recording time). Recording repeats until the STOP key is pressed. Off: Recording is performed once until it stops.	
Specified time/continuous	Specified time	The recording time is set in days, hours, minutes, and seconds. The time can be set up to the maximum capacity of the internal buffer memory (total of 256 M data points).
	Continuous	Recording is performed once until it is stopped. If the maximum capacity of the internal buffer memory is exceeded, the memory will be overwritten.
Waveform recording	The last 256 M data points (when recording 1 analog channel; if recording n channels, 256 M/ n data points) are saved in the internal buffer memory. The user can scroll through and view data stored in the internal buffer memory. Alarm source data recording can be toggled on and off. Number of occupied channels (n) When alarm source data recording is enabled $n = \text{Number of analog channels} + \text{number of pulse channels} \times 2 + \text{number of logic channels} \times 1 + \text{number of waveform calculation channels} \times 4 + 26$ When alarm source data recording is disabled $n = \text{Number of analog channels} + \text{number of pulse channels} \times 2 + \text{number of logic channels} \times 1 + \text{number of waveform calculation channels} \times 4$	
Backup of recorded data	None	

3. Display

Sheet function	Display sheets can be switched between all channels and individual modules. All-channel display sheet: Maximum 120 analog channels, 30 waveform calculation channels, 8 pulse/logic channels, 8 alarm channels	
Waveform display screen	Time-axis waveform display	Simultaneous display of gages and settings (channel representative settings and display settings)
	Simultaneous display of time-axis waveforms and values	Instantaneous values, cursor values, or numerical calculation values (user-switchable)
	Numerical display	Simultaneous display of instantaneous values and statistical values
	Alarm display	Display of alarm status and alarm history
Display format	Time-axis waveform display: 1 screen	
Numerical display format	SI units, decimal, or exponent (user-selectable) When decimal is selected, the number of decimal places to display can be set (values will then be rounded to the set number of places).	
Waveform colors	24 colors	
Zooming in and out on the waveform display	Horizontal axis	2 ms, 5 ms, 10 ms, 20 ms, 50 ms, 100 ms, 200 ms, 500 ms, 1 s, 2 s, 5 s, 10 s, 20 s, 30 s, 1 min., 2 min., 5 min., 10 min., 20 min., 30 min., 1 h, 2 h, 5 h, 10 h, 12 h, 1 day/division
	Vertical axis	Number of divisions per screen: 10 Setting method Select position or upper and lower limits for each channel. (Waveform calculation channels: upper and lower limits only) • When setting by position: Set zoom factor and zero position. Zoom factor: 1/2×, 1×, 2×, 5×, 10×, 20×, 50×, 100× Zero position: -50% to 150% (with a zoom factor of 1×) • When setting by upper/lower limit: Set the upper and lower limit.
Waveform scrolling	The display can be scrolled left and right both during recording and while recording is stopped (during waveform rendering only).	
Monitor display	The user can check instantaneous values and waveforms without recording data to memory (values and waveforms can be displayed while waiting for a trigger).	

4. Files

-1. Saving

Save destinations	SD Memory Card/USB Drive (user-selectable)
Filenames	Up to 8 single-byte characters Automatic numbering/dating (user-selectable)
Auto saving	Waveform data (real-time saving) Off, binary format, or text format (user-selectable) Numerical calculation results (saved after recording) Off or text format (user-selectable) When text format is selected, the user can choose whether to save all calculations in one file or to save each calculation in its own file.
Priority save destination	SD Memory Card/USB Drive (user-selectable) The user can choose whether to give priority to the SD Memory Card or the USB Drive for saving data when both are inserted.
Delete and save	On/Off (user-selectable) Off: The system will stop saving data when the SD Memory Card or USB Drive starts to run out of available space. On: When the SD Memory Card or USB Drive starts to run out of available space, the system will delete the oldest waveform file (binary or text) and then continue saving data. When both an SD Memory Card and USB Drive are inserted, the system will perform delete and save on the media that has been set as the priority save destination only.
Folder segmentation	No segmentation, 1 day, 1 week, or 1 month (user-selectable)
File segmentation	Enable/disable (user-selectable) Disabled: Data for each recording session is saved in its own file. Enabled: Data for each set period of time is saved in its own file, starting with the start of measurement. Segmentation time: Day, hour, or minute (user-selectable)
External media eject (SD Memory Card/USB Drive)	External media can be ejected during real-time saving by activating a button on the screen and confirming a message. • When both an SD Memory Card and USB Drive are inserted and the media set as the priority save destination is ejected, the system will continue to save data on the other media. • When either an SD Memory Card or a USB Drive is inserted and the media set as the priority save destination is ejected, the system will stop saving data. If external media is reinserted under these conditions, the system will continue saving data remaining in the internal buffer memory to a different file.
Data protection	Yes (valid only when the Z1007 Battery Pack is installed) If the remaining battery life declines during real-time saving, the system will close the file and stop saving data (although measurement operation will continue).
Manual saving	Data is saved when the SAVE key is pressed. The user can choose either selective save or immediate save as the operation to perform when the SAVE key is pressed.
Selective save	The user will be prompted to choose what to save: settings, waveform data (binary format), waveform data (text format), numerical calculation results (all calculations in one file or each calculation in its own file), display image (PNG format).
Immediate save	Data will be saved immediately when the SAVE key is pressed. The type of data to save is set in advance along with the format and range. Filenames can be entered when saving data.

Decimation (text format only)	Decimate and save	Off or a value from 1/2 to 1/100,000 (user-selectable)
--	-------------------	--

-2. Loading data

Loading saved data	The user can specify a position and then load up to 256 M data points of previously saved text-format data (when recording 1 analog channel; if recording <i>n</i> channels, 256 M/ <i>n</i> data points).	
---------------------------	--	--

5. Calculations

Numerical calculations	Number of calculations	Up to 10 calculations simultaneously
	Calculation content	Average value, peak-to-peak value, maximum value, maximum value time, minimum value, minimum value time, integral* ¹ , integration* ¹ , moving average* ² , on time* ² , off time* ² , on count* ² , off count* ² *1: Total, positive, negative, or absolute value (user-selectable) *2: Threshold values can be set for individual channels.
	Calculation range	During recording: Calculations performed for all data during recording After recording has stopped: Calculations performed for all data in the internal buffer memory, or for data in a calculation range specified by the A/B cursors (on the vertical axis)
	Time segmentation calculations	Enable/disable (user-selectable) Disabled: Calculations performed for all data during recording Enabled: Data for each segment of time, starting with the start of measurement Segmentation time: Set DD HH:MM format
Waveform calculations	Calculation content	The following calculations can be set: <ul style="list-style-type: none"> • Four arithmetic operations* among channels • Moving average, simple average, integral, and integration of any channel Calculated values are recorded as data for the calculation channels (W1 through W30). (Calculations are performed at the same time as measurement. Values cannot be recalculated after measurement.) *: Calculation expression (A*CHa □ B*CHb □ C*CHc □ D*CHd) ■ E where A, B, C, D, E: User-specified constants CHa, CHb, CHc, CHd: User-specified measurement channels □: Plus (+), minus (-), multiplication (*), or division(/) (one operation) ■: Plus (+), minus (-), multiplication (*), division(/), or exponentiation (^) (one operation)

6. Triggers

Trigger method	Digital comparison method	
Trigger timing	Start, stop, or start & stop	
Trigger conditions	AND/OR operation performed on trigger source, interval trigger, or external trigger When triggers are disabled, free run	
Trigger sources	Analog, pulse, logic, waveform calculations	
Trigger types	Analog, pulse, waveform calculations	Level triggers Trigger activated by rising or falling edge at set level Window triggers Set by trigger level upper limit and lower limit Trigger activated when value leaves area or when value enters area
	Logic	Trigger activated when patterns of 1/0/X match (where "X" indicates either)
Interval triggers	Trigger activated for set recording interval after setting days/hours/minutes/seconds	
External triggers	Trigger activated by rising or falling edge at set level in external input signal Rising/falling (user-selectable)	
Trigger response time	With plug-in module(s)	(Recording interval or data refresh interval, whichever is longer) $\times 2 + 1$ ms + (analog response time)* *: Depending on filter settings (U8554 with a data refresh interval of 5 ms and low-pass filter of 120 Hz).
Trigger level resolution	Analog	0.1% f.s. (f.s. = 10 divisions)
	Pulse	Integration 1c, rotational speed 1/n (where n = pulse count per rotation setting)
Pre-triggers	Set day/hours/minutes/seconds. Can be set during real-time saving.	

7. Alarms

Alarm conditions	Set separately for ALM1 to ALM8 The system will output an alarm when any of the following conditions are satisfied: <ul style="list-style-type: none"> • AND/OR operation performed on alarm sources • Low battery • Thermocouple wire break 	
Alarm sources	Analog, pulse, logic, waveform calculations	
Low remaining battery life	The system will output an alarm when the instrument's remaining battery life declines.	
Thermocouple wire break	The system will output an alarm when a thermocouple wire break occurs (when the thermocouple wire break detection setting is enabled).	
Types of alarms	Analog, pulse, waveform calculations	<p>Level The system will output an alarm following a rising or falling edge at set level.</p> <hr/> <p>Window Set upper limit and lower limit. The system will output an alarm when value leaves area or when value enters area.</p> <hr/> <p>Slope The system will output an alarm when the rate of change exceeds the set value.</p>
	Logic	The system will output an alarm when patterns of 1/0/X match (where "X" indicates either).
	Alarm filter	Apply a filter to the results of AND/OR operations performed on alarm sources. Set based on sample count (Off, 2 to 1000). The system will output an alarm if the alarm state continues for the set number of samples.
	Alarm setting resolution	<p>Analog 0.1% f.s. (f.s. = 10 divisions)</p> <hr/> <p>Pulse Integration 1c, rotational speed 1/n (where n = pulse count per rotation setting)</p>
Alarm retention	On/Off (user-selectable) Clear alarms: When alarm retention is On, alarms will be cleared without stopping recording.	
Alarm tone	On/Off (user-selectable)	
Alarm output response time	With plug-in module(s) (Recording interval or data refresh interval, whichever is longer) × 2 + 1 ms + (analog response time)*	
	*: Depending on filter settings (U8554 with a data refresh interval of 5 ms and low-pass filter of 120 Hz).	

8. Other functionality

Even mark function	Even mark entry method	Perform the following operation during recording: <ol style="list-style-type: none"> (1) Pressing the START key (2) With [Mark] chosen on the screen, pressing the ENTER key. (3) Inputting a signal to an external input terminal Alternatively, configuring the event mark setting so that an event mark is entered responding to alarm (can be toggled on and off).
	Number of inputs	Up to 1000 inputs per measurement

Waveform search function	Search waveforms and display target location in the center of the waveform screen.	
	Search conditions	Search by choosing level, window, maximum value, minimum value, local maximum value, or local minimum value.
	Search range	All data in the internal buffer memory or data between the A/B cursors (on the vertical axis)
	Search targets	Analog, pulse, logic, waveform calculations
Jump function	Specify the event mark, A/B cursor position, trigger point, or waveform display position to display in the center of the waveform screen.	
Cursor measurement function	Cursor display	All channels or specified channels (user-selectable)
	Cursor movement	A, B, or simultaneous (user-selectable)
	Types of cursors	Vertical or horizontal (user-selectable) Vertical Display of the following values: <ul style="list-style-type: none"> • Time values at the A and B cursors • Measured values of waveforms at the A and B cursors • Difference between time values or measured values of waveforms at the A and B cursors. Horizontal Display of the following value: <ul style="list-style-type: none"> • Values at the A and B cursor • Difference between values at the A and B cursors.
Scaling function	Scaling settings can be configured separately for each channel.	
	Analog	Set by conversion rate, by 2 points, by strain gage rating (Strain Unit only), or by sensitivity (user-selectable)
	Pulse (integration)	Set by physical value per pulse or number of pulses per physical value (user-selectable)
	Pulse (rotational speed)	Set by conversion rate or by 2 points (user-selectable)
	Temperature display in degrees Fahrenheit	When display language is set to English, Fahrenheit temperature scaling is available.
Comment entry function	Enter titles and channel-specific comments (values, alphabetical characters, and symbols).	
Start state retention function	On/Off (user-selectable) When enabled, the system will enter the re-start state and automatically start recording if the power is turned off during recording and then turned back on (or the trigger standby state if using a trigger).	
Prevention of inadvertent START/ STOP key operation	When the START or STOP key is pressed, the system will display a message asking whether the user wishes to start or stop measurement. Confirmation message: Enable/disable (user-selectable)	
Key lock function	Disables operation keys (enabled/disabled by pressing and holding the ESC key for 3 s or more).	
Beep tone	On/Off (user-selectable)	
Self-check function	Can check keys, LCD, ROM/RAM, LAN, media, and modules.	
Display of horizontal axis (time values)	Horizontal axis (time value) display can be set to time, date, or data point count. Setting is applied when text data is saved.	
Configuration navigation (Quick Set) function	Connection diagram display (Strain gage, external terminals)	
Power supply frequency filter function	50 Hz/60 Hz selection	

9. Input

Pulse/logic input	Number of channels	8 channels (common GND, non-isolated) Exclusive setting for pulse/logic input for individual channels	
	Terminal block	Push-button type terminal block	
	Adaptive input format	Non-voltage contact, open collector (PNP open collector requires external resistor), or voltage input	
	Maximum input voltage	0 V to 42 V DC	
	Input resistance	1.1 M Ω \pm 5%	
	Detection level	2 levels (user-selectable) High: 1.0 V or greater; low: 0 to 0.5 V High: 4.0 V or greater; low: 0 to 1.5 V	
	Pulse input	Measurement range, resolution	
	Measurement target	Range	Maximum resolution
	Integration	1000 M pulse f.s.	1 pulse
	Rotational speed	5000/n (r/s) f.s.	1/n (r/s)
		300,000/n (r/min.) f.s.	1/n (r/min.)
	n: Number of pulses per rotation (1 to 1000)		
	Pulse input period	With filter off: 200 μ s or greater (100 μ s or greater during high and low interval) With filter on: 100 ms or greater (50 ms or greater during high and low interval)	
	Slope	Set rising/falling for each channel.	
	Measurement mode	Integration (addition, instantaneous), rotational speed	
	Integration	Addition: Counts the number of pulses input from start of measurement. Instantaneous: Counts the number of pulses input within each recording interval (integrated value is reset for each rotational interval).	
	Rotational speed	r/s: Counts the number of input pulses during 1 s and calculates the rotational speed. r/min.: Counts the number of input pulses during 1 min. and calculates the rotational speed.	
	Smoothing function	Select value from 1 s to 60 s (valid only when set to rotational speed and r/min.).	
	Chatter prevention filter	Set to On/Off for each channel.	
Logic input	Measurement mode	Records 1 or 0 for each recording interval.	

10. Accessories and options

Accessories	See "Accessories" in the Quick Start Manual.
Options	See "Options (sold separately)" in the Quick Start Manual.

10.2 Plug-in Module Specifications

U8550 Voltage/Temp Unit

1. General specifications

Compatible logger	LR8450/LR8450-01 Memory HiLogger
Operating environment	Indoors, Pollution Degree 2, altitude up to 2000 m (6562 ft.)
Operating temperature and humidity range	-10°C to 50°C (14°F to 122°F), 80% RH or less (non-condensing)
Storage temperature and humidity range	-20°C to 60°C (-4°F to 140°F), 80% RH or less (non-condensing)
Standards	Safety: EN 61010 EMC: EN 61326, Class A
Standard compliance	Thermocouples: JIS C1602:2015, IEC 60584-1:2013
Vibration resistance	JIS D 1601:1995:1995 5.3 (1) Class 1: Passenger vehicles; conditions: Class A equivalent (4 h along X-axis and 2 h along Y- and Z-axes at a vibration acceleration of 45 m/s ² [4.6 G])
Dimensions	Approx. 134W × 70H × 63D mm (5.28"W × 2.76"H × 2.48"D) (including cover)
Mass	Approx. 345 g (12.2 oz.)
Product warranty period	3 years
Accessories	Instruction Manual Installation screws × 2
Options	Z2000 Humidity Sensor

2. Input, output, and measurement specifications

-1. Basic specifications

Number of input channels	15 (Set voltage, thermocouple, or humidity for each channel.)
Input terminals	M3 screw-type terminal block (2 terminals per channel), outfitted with terminal block cover
Measurement target	Voltage Thermocouples (K, J, E, T, N, R, S, B, C) Humidity (using the Z2000 Humidity Sensor)
Input type	Scanning by semiconductor relays, floating unbalanced input All channels isolated
A/D resolution	16 bits
Maximum input voltage	±100 V DC
Maximum channel-to-channel voltage	300 V DC
Maximum rated terminal-to-ground voltage	300 V AC, DC (Measurement Category II) Between any input channel (+, -) and the instrument (LR8450/LR8450-01) or between any two modules Anticipated transient overvoltage: 2500 V

Input resistance	10 MΩ or greater (10 mV f.s. to 2 V f.s. voltage ranges, all thermocouple ranges) 1 MΩ ±5% (10 V f.s. to 100 V f.s. voltage range, 1-5 V f.s. voltage range, humidity range)
Allowable signal source resistance	1 kΩ or less
Reference junction compensation	Internal/external (user-selectable) (during thermocouple measurement)
Thermocouple wire break detection	The system will check for wire breaks each data refresh interval during thermocouple measurement. On/Off (user-selectable) (set for entire module) Detection current: 5 μA ±20% No current flows while acquiring measurement data. (Setting not available when the data refresh interval is set to 10 ms.)
Data refresh interval	10 ms*, 20 ms, 50 ms, 100 ms, 200 ms, 500 ms, 1 s, 2 s, 5 s, 10 s *: Setting available when thermocouple wire break detection is disabled.
Digital filters	The digital filter cutoff frequency is automatically set as described in the following table according to the data refresh interval, Wire break detection setting, and power supply frequency filter setting:

–: Setting not available

Power supply frequency filter setting	Wire break detection setting	Data refresh interval									
		10 ms	20 ms	50 ms	100 ms	200 ms	500 ms	1 s	2 s	5 s	10 s
60 Hz	Off	20.8 k	6.94 k	2.98 k	2.37 k	739	60	60	60	60	60
	On	–	20.8 k	6.94 k	2.98 k	2.37 k	739	60	60	60	60
50 Hz	Off	20.8 k	6.94 k	2.98 k	2.37 k	739	50	50	50	50	50
	On	–	20.8 k	6.94 k	2.98 k	2.37 k	739	50	50	50	50

Unit: Hz

-2. Accuracy specifications

Accuracy guarantee conditions	Accuracy guarantee period	1 year
	Accuracy guarantee period after adjustment made by Hioki	1 year
	Accuracy guarantee temperature and humidity range	23°C ±5°C (73°F±9°F), 80% RH or less
	Warm-up time	At least 30 min. after connecting to the LR8450/LR8450-01 Memory HiLogger and turning on the instrument
The conditions have been specified with after zero-adjustment finished and the cutoff frequency set to 50 Hz/60 Hz (see cutoff frequency table in “Digital filters” [p.244]).		

Measurement range, maximum resolution, measurable range, and measurement accuracy figures

Measurement target	Type	Range	Maximum resolution	Measurable range	Measurement accuracy
Voltage	–	10 mV f.s.	500 nV	–10 mV to 10 mV	±10 µV
		20 mV f.s.	1 µV	–20 mV to 20 mV	±20 µV
		100 mV f.s.	5 µV	–100 mV to 100 mV	±50 µV
		200 mV f.s.	10 µV	–200 mV to 200 mV	±100 µV
		1 V f.s.	50 µV	–1 V to 1 V	±500 µV
		2 V f.s.	100 µV	–2 V to 2 V	±1 mV
		10 V f.s.	500 µV	–10 V to 10 V	±5 mV
		20 V f.s.	1 mV	–20 V to 20 V	±10 mV
		100 V f.s.	5 mV	–100 V to 100 V	±50 mV
		1-5 V f.s.	500 µV	1 V to 5 V	±5 mV
Thermocouple (Not including accuracy of reference junction compensation)	K	100°C f.s.	0.01°C	Greater than or equal to –100°C and less than 0°C	±0.7°C
				Greater than or equal to 0°C and less than or equal to 100°C	±0.5°C
		500°C f.s.	0.05°C	Greater than or equal to –200°C and less than –100°C	±1.4°C
				Greater than or equal to –100°C and less than 0°C	±0.7°C
				Greater than or equal to 0°C and less than or equal to 500°C	±0.5°C
		2000°C f.s.	0.1°C	Greater than or equal to –200°C and less than –100°C	±1.4°C
				Greater than or equal to –100°C and less than 0°C	±0.7°C
				Greater than or equal to 0°C and less than 500°C	±0.5°C
	Greater than or equal to 500°C and less than or equal to 1350°C			±0.7°C	
	Greater than or equal to 0°C and less than or equal to 1200°C			±0.5°C	
	J	100°C f.s.	0.01°C	Greater than or equal to –100°C and less than 0°C	±0.7°C
				Greater than or equal to 0°C and less than or equal to 100°C	±0.5°C
		500°C f.s.	0.05°C	Greater than or equal to –200°C and less than –100°C	±0.9°C
				Greater than or equal to –100°C and less than 0°C	±0.7°C
				Greater than or equal to 0°C and less than or equal to 500°C	±0.5°C
		2000°C f.s.	0.1°C	Greater than or equal to –200°C and less than –100°C	±0.9°C
Greater than or equal to –100°C and less than 0°C				±0.7°C	
Greater than or equal to 0°C and less than or equal to 1200°C				±0.5°C	

Measurement target	Type	Range	Maximum resolution	Measurable range	Measurement accuracy	
Thermocouple (Not including accuracy of reference junction compensation)	E	100°C f.s.	0.01°C	Greater than or equal to -100°C and less than 0°C	±0.7°C	
				Greater than or equal to 0°C and less than or equal to 100°C	±0.5°C	
		500°C f.s.	0.05°C	Greater than or equal to -200°C and less than -100°C	±0.9°C	
				Greater than or equal to -100°C and less than 0°C	±0.7°C	
				Greater than or equal to 0°C and less than or equal to 500°C	±0.5°C	
		2000°C f.s.	0.1°C	Greater than or equal to -200°C and less than -100°C	±0.9°C	
				Greater than or equal to -100°C and less than 0°C	±0.7°C	
				Greater than or equal to 0°C and less than or equal to 1000°C	±0.5°C	
		T	100°C f.s.	0.01°C	Greater than or equal to -100°C and less than 0°C	±0.7°C
					Greater than or equal to 0°C and less than or equal to 100°C	±0.5°C
			500°C f.s.	0.05°C	Greater than or equal to -200°C and less than -100°C	±1.4°C
					Greater than or equal to -100°C and less than 0°C	±0.7°C
	Greater than or equal to 0°C and less than or equal to 400°C				±0.5°C	
	2000°C f.s.		0.1°C	Greater than or equal to -200°C and less than -100°C	±1.4°C	
				Greater than or equal to -100°C and less than 0°C	±0.7°C	
				Greater than or equal to 0°C and less than or equal to 400°C	±0.5°C	
	N		100°C f.s.	0.01°C	Greater than or equal to -100°C and less than 0°C	±1.1°C
					Greater than or equal to 0°C and less than or equal to 100°C	±0.9°C
			500°C f.s.	0.05°C	Greater than or equal to -200°C and less than -100°C	±2.1°C
					Greater than or equal to -100°C and less than 0°C	±1.1°C
		Greater than or equal to 0°C and less than or equal to 500°C			±0.9°C	
		2000°C f.s.	0.1°C	Greater than or equal to -200°C and less than -100°C	±2.1°C	
				Greater than or equal to -100°C and less than 0°C	±1.1°C	
				Greater than or equal to 0°C and less than or equal to 1300°C	±0.9°C	

Measurement target	Type	Range	Maximum resolution	Measurable range	Measurement accuracy		
Thermocouple (Not including accuracy of reference junction compensation)	R	100°C f.s.	0.01°C	0°C to 100°C	±4.4°C		
				500°C f.s.	0.05°C	Greater than or equal to 0°C and less than 100°C	±4.4°C
						Greater than or equal to 100°C and less than 300°C	±2.9°C
		Greater than or equal to 300°C and less than or equal to 500°C	±2.2°C				
		2000°C f.s.	0.1°C	Greater than or equal to 0°C and less than 100°C	±4.4°C		
				Greater than or equal to 100°C and less than 300°C	±2.9°C		
				Greater than or equal to 300°C and less than or equal to 1700°C	±2.2°C		
		S	100°C f.s.	0.01°C	0°C to 100°C	±4.4°C	
					500°C f.s.	0.05°C	Greater than or equal to 0°C and less than 100°C
	Greater than or equal to 100°C and less than 300°C						±2.9°C
	Greater than or equal to 300°C and less than or equal to 500°C		±2.2°C				
	2000°C f.s.		0.1°C	Greater than or equal to 0°C and less than 100°C	±4.4°C		
				Greater than or equal to 100°C and less than 300°C	±2.9°C		
				Greater than or equal to 300°C and less than or equal to 1700°C	±2.2°C		
	B		2000°C f.s.	0.1°C	Greater than or equal to 400°C and less than 600°C	±5.4°C	
					Greater than or equal to 600°C and less than 1000°C	±3.7°C	
		Greater than or equal to 1000°C and less than or equal to 1800°C			±2.4°C		
	C	100°C f.s.	0.01°C	0°C to 100°C	±1.7°C		
500°C f.s.		0.05°C	0°C to 500°C	±1.7°C			
2000°C f.s.		0.1°C	0°C to 2000°C	±1.7°C			

Measurement target	Type	Range	Maximum resolution	Measurable range	Measurement accuracy
Humidity	–	100% RH f.s.	0.1% RH	5.0% RH to 95.0% RH	As per measurement accuracy of the Z2000 Humidity Sensor
<p>The graph plots Relative Humidity (% RH) on the y-axis (0 to 100) against Temperature (°C) on the x-axis (-40 to 85). A central shaded region indicates the guaranteed accuracy range from 0% to 100% RH. The accuracy is divided into three horizontal bands: the top band (80-100% RH) has ±10% RH accuracy; the middle band (60-80% RH) has ±8% RH accuracy; and the bottom band (0-60% RH) has ±6% RH accuracy. Vertical labels 'Outside guarantee range' are present for temperatures below 0°C and above 85°C.</p>					

Accuracy of reference junction compensation	±0.5°C (with input terminal temperature balancing) Reference junction compensation: Add thermocouple measurement accuracy when set to <i>internal</i> .
Temperature characteristics	Add (measurement accuracy × 0.1) per degree (for humidity, see humidity accuracy table).
Normal mode rejection ratio	50 dB or greater (With 50 Hz input, power supply frequency filter of 50 Hz, and a data refresh interval of 5 s) (With 60 Hz input, power supply frequency filter of 60 Hz, and a data refresh interval of 5 s) (With thermocouple wire break detection disabled)
Common mode rejection ratio	Signal source resistance of 100 Ω or less 100 dB or greater (With 50 Hz/60 Hz input and a data refresh interval of 10 ms) 140 dB or greater (With 50 Hz input, power supply frequency filter of 50 Hz, and a data refresh interval of 5 s in the 10 mV f.s. range) (With 60 Hz input, power supply frequency filter of 60 Hz, and a data refresh interval of 5 s in the 10 mV f.s. range) (With thermocouple wire break detection disabled)
Effect of radiated radio-frequency electromagnetic field	±5% f.s. (80 MHz to 1 GHz: 10 V/m; 1 GHz to 6 GHz: 3 V/m) (in the 10 V f.s. voltage range)
Effect of conducted radio-frequency electromagnetic field	±5% f.s. at 10 V (in the 10 V f.s. voltage range)

U8551 Universal Unit

1. General specifications

Compatible logger	LR8450/LR8450-01 Memory HiLogger
Operating environment	Indoors, Pollution Degree 2, altitude up to 2000 m (6562 ft.)
Operating temperature and humidity range	-10°C to 50°C (14°F to 122°F), 80% RH or less (non-condensing)
Storage temperature and humidity range	-20°C to 60°C (-4°F to 140°F), 80% RH or less (non-condensing)
Standards	Safety: EN 61010 EMC: EN 61326, Class A
Standard compliance	Thermocouples: JIS C1602:2015, IEC 60584-1:2013 Resistance temperature detector (Pt100, Pt1000): JIS C1604:2013, IEC 60751:2008 Resistance temperature detector (JPt100): JIS C1604:1989
Vibration resistance	JIS D 1601:1995 5.3 (1) Class 1: Passenger vehicles; conditions: Class A equivalent (4 h along X-axis and 2 h along Y- and Z-axes at a vibration acceleration of 45 m/s ² [4.6 G])
Dimensions	Approx. 134W × 70H × 63D mm (5.28"W × 2.76"H × 2.48"D) (including cover)
Mass	Approx. 318 g (11.2 oz.)
Product warranty period	3 years
Accessories	Instruction Manual Installation screws × 2
Options	Z2000 Humidity Sensor

2. Input, output, and measurement specifications

-1. Basic specifications

Number of input channels	15 (Set voltage, thermocouple, humidity, resistance temperature detector, or resistor for each channel.)
Input terminals	Push-button type terminal block (4 terminals per channel), outfitted with terminal block cover
Measurement target	Voltage Thermocouples (K, J, E, T, N, R, S, B, C) Humidity (using the Z2000 Humidity Sensor) Resistance temperature detector (Pt100, Jpt100, Pt1000) (Connection: 3-wire/4-wire) (Measurement current: 1 mA ±5% [Pt100 and Jpt100 measurement]; 0.1 mA ±5% [Pt1000 measurement]) (During Pt1000 measurement, setting available when the data refresh interval is greater than 100 ms.) Resistor (connection: 4-wire; measurement current: 1 mA ±5%)
Input type	Scanning by semiconductor relays, floating unbalanced input All channels isolated (The SoL terminals used to measure resistance temperature detectors and resistors are not isolated as they are shorted for all channels internally.)
A/D resolution	16 bits
Maximum input voltage	±100 V DC
Maximum channel-to-channel voltage	300 V DC (The SoL terminals used to measure resistance temperature detectors and resistors are not isolated as they are shorted for all channels internally.)

Maximum rated terminal-to-ground voltage	300 V AC, DC (Measurement Category II) Between any input channel (SoH, SoL, +, -) and the instrument (LR8450/LR8450-01) or between any two modules Anticipated transient overvoltage: 2500 V
Input resistance	10 MΩ or greater (10 mV f.s. to 2 V f.s. voltage ranges, all thermocouple ranges, all resistance bulb and resistor ranges) 1 MΩ ±5% (10 V f.s. to 100 V f.s. voltage range, 1-5 V f.s. voltage range, humidity range)
Allowable signal source resistance	1 kΩ or less
Reference junction compensation	Internal/external (user-selectable) (during thermocouple measurement)
Thermocouple wire break detection	The system will check for wire breaks each data refresh interval during thermocouple measurement. On/Off (user-selectable) (set for entire module) Detection current: 5 μA ±20% (No current flows while acquiring measurement data.) (Setting not available when the data refresh interval is set to 10 ms.)
Data refresh interval	10 ms*1, 20 ms*2, 50 ms*2, 100 ms, 200 ms, 500 ms, 1 s, 2 s, 5 s, 10 s *1: Setting available when thermocouple wire break detection is disabled and not set for Pt1000 measurement. *2: Setting available when not set for Pt1000 measurement.
Digital filters	The digital filter cutoff frequency is automatically set as described in the following table according to the data refresh interval, Wire break detection setting, and power supply frequency filter setting: --: Setting not available

Power supply frequency filter setting	Wire break detection setting	Data refresh interval									
		10 ms*3	20 ms*3	50 ms*3	100 ms	200 ms	500 ms	1 s	2 s	5 s	10 s
60 Hz	Off	20.8 k	6.94 k	2.98 k	2.37 k	739	60	60	60	60	60
	On	--	20.8 k	6.94 k	2.98 k	2.37 k	739	60	60	60	60
50 Hz	Off	20.8 k	6.94 k	2.98 k	2.37 k	739	50	50	50	50	50
	On	--	20.8 k	6.94 k	2.98 k	2.37 k	739	50	50	50	50

Unit: Hz

*3: Setting not available when mixed with Pt1000 measurement.

-2. Accuracy specifications

Accuracy guarantee conditions	Accuracy guarantee period	1 year
	Accuracy guarantee period after adjustment made by Hioki	1 year
	Accuracy guarantee temperature and humidity range	23°C ±5°C (73°F±9°F), 80% RH or less
	Warm-up time	At least 30 min. after connecting to the LR8450/LR8450-01 Memory HiLogger and turning on the instrument
The conditions have been specified with zero-adjustment finished and the cutoff frequency set to 50 Hz/60 Hz (see cutoff frequency table in "Digital filters" [p.250]).		

Measurement range, maximum resolution, measurable range, and measurement accuracy figures

Measurement target	Type	Range	Maximum resolution	Measurable range	Measurement accuracy
Voltage	–	10 mV f.s.	500 nV	–10 mV to 10 mV	±10 µV
		20 mV f.s.	1 µV	–20 mV to 20 mV	±20 µV
		100 mV f.s.	5 µV	–100 mV to 100 mV	±50 µV
		200 mV f.s.	10 µV	–200 mV to 200 mV	±100 µV
		1 V f.s.	50 µV	–1 V to 1 V	±500 µV
		2 V f.s.	100 µV	–2 V to 2 V	±1 mV
		10 V f.s.	500 µV	–10 V to 10 V	±5 mV
		20 V f.s.	1 mV	–20 V to 20 V	±10 mV
		100 V f.s.	5 mV	–100 V to 100 V	±50 mV
		1-5 V f.s.	500 µV	1 V to 5 V	±5 mV
Thermocouple (Not including accuracy of reference junction compensation)	K	100°C f.s.	0.01°C	Greater than or equal to –100°C and less than 0°C	±0.7°C
				Greater than or equal to 0°C and less than or equal to 100°C	±0.5°C
		500°C f.s.	0.05°C	Greater than or equal to –200°C and less than –100°C	±1.4°C
				Greater than or equal to –100°C and less than 0°C	±0.7°C
				Greater than or equal to 0°C and less than or equal to 500°C	±0.5°C
		2000°C f.s.	0.1°C	Greater than or equal to –200°C and less than –100°C	±1.4°C
				Greater than or equal to –100°C and less than 0°C	±0.7°C
				Greater than or equal to 0°C and less than 500°C	±0.5°C
	Greater than or equal to 500°C and less than or equal to 1350°C			±0.7°C	
	J	100°C f.s.	0.01°C	Greater than or equal to –100°C and less than 0°C	±0.7°C
				Greater than or equal to 0°C and less than or equal to 100°C	±0.5°C
		500°C f.s.	0.05°C	Greater than or equal to –200°C and less than –100°C	±0.9°C
				Greater than or equal to –100°C and less than 0°C	±0.7°C
				Greater than or equal to 0°C and less than or equal to 500°C	±0.5°C
		2000°C f.s.	0.1°C	Greater than or equal to –200°C and less than –100°C	±0.9°C
Greater than or equal to –100°C and less than 0°C				±0.7°C	
Greater than or equal to 0°C and less than or equal to 1200°C				±0.5°C	

Measurement target	Type	Range	Maximum resolution	Measurable range	Measurement accuracy	
Thermocouple (Not including accuracy of reference junction compensation)	E	100°C f.s.	0.01°C	Greater than or equal to -100°C and less than 0°C	±0.7°C	
				Greater than or equal to 0°C and less than or equal to 100°C	±0.5°C	
		500°C f.s.	0.05°C	Greater than or equal to -200°C and less than -100°C	±0.9°C	
				Greater than or equal to -100°C and less than 0°C	±0.7°C	
				Greater than or equal to 0°C and less than or equal to 500°C	±0.5°C	
		2000°C f.s.	0.1°C	Greater than or equal to -200°C and less than -100°C	±0.9°C	
				Greater than or equal to -100°C and less than 0°C	±0.7°C	
				Greater than or equal to 0°C and less than or equal to 1000°C	±0.5°C	
		T	100°C f.s.	0.01°C	Greater than or equal to -100°C and less than 0°C	±0.7°C
					Greater than or equal to 0°C and less than or equal to 100°C	±0.5°C
			500°C f.s.	0.05°C	Greater than or equal to -200°C and less than -100°C	±1.4°C
					Greater than or equal to -100°C and less than 0°C	±0.7°C
	Greater than or equal to 0°C and less than or equal to 400°C				±0.5°C	
	2000°C f.s.		0.1°C	Greater than or equal to -200°C and less than -100°C	±1.4°C	
				Greater than or equal to -100°C and less than 0°C	±0.7°C	
				Greater than or equal to 0°C and less than or equal to 400°C	±0.5°C	
	N		100°C f.s.	0.01°C	Greater than or equal to -100°C and less than 0°C	±1.1°C
					Greater than or equal to 0°C and less than or equal to 100°C	±0.9°C
			500°C f.s.	0.05°C	Greater than or equal to -200°C and less than -100°C	±2.1°C
					Greater than or equal to -100°C and less than 0°C	±1.1°C
		Greater than or equal to 0°C and less than or equal to 500°C			±0.9°C	
		2000°C f.s.	0.1°C	Greater than or equal to -200°C and less than -100°C	±2.1°C	
				Greater than or equal to -100°C and less than 0°C	±1.1°C	
				Greater than or equal to 0°C and less than or equal to 1300°C	±0.9°C	

Measurement target	Type	Range	Maximum resolution	Measurable range	Measurement accuracy
Thermocouple (Not including accuracy of reference junction compensation)	R	100°C f.s.	0.01°C	0°C to 100°C	±4.4°C
				Greater than or equal to 0°C and less than 100°C	±4.4°C
				Greater than or equal to 100°C and less than 300°C	±2.9°C
		500°C f.s.	0.05°C	Greater than or equal to 300°C and less than or equal to 500°C	±2.2°C
				Greater than or equal to 0°C and less than 100°C	±4.4°C
				Greater than or equal to 100°C and less than 300°C	±2.9°C
		2000°C f.s.	0.1°C	Greater than or equal to 300°C and less than or equal to 1700°C	±2.2°C
				Greater than or equal to 0°C and less than 100°C	±4.4°C
				Greater than or equal to 100°C and less than 300°C	±2.9°C
	S	100°C f.s.	0.01°C	0°C to 100°C	±4.4°C
				Greater than or equal to 0°C and less than 100°C	±4.4°C
				Greater than or equal to 100°C and less than 300°C	±2.9°C
		500°C f.s.	0.05°C	Greater than or equal to 300°C and less than or equal to 500°C	±2.2°C
				Greater than or equal to 0°C and less than 100°C	±4.4°C
				Greater than or equal to 100°C and less than 300°C	±2.9°C
		2000°C f.s.	0.1°C	Greater than or equal to 300°C and less than or equal to 1700°C	±2.2°C
				Greater than or equal to 0°C and less than 100°C	±4.4°C
				Greater than or equal to 100°C and less than 300°C	±2.9°C
B	2000°C f.s.	0.1°C	Greater than or equal to 400°C and less than 600°C	±5.4°C	
			Greater than or equal to 600°C and less than 1000°C	±3.7°C	
			Greater than or equal to 1000°C and less than or equal to 1800°C	±2.4°C	
C	100°C f.s.	0.01°C	0°C to 100°C	±1.7°C	
	500°C f.s.	0.05°C	0°C to 500°C	±1.7°C	
	2000°C f.s.	0.1°C	0°C to 2000°C	±1.7°C	
Humidity	-	100% RH f.s.	0.1% RH	5.0% RH to 95.0% RH	As per measurement accuracy of the Z2000 Humidity Sensor

Measurement target	Type	Range	Maximum resolution	Measurable range	Measurement accuracy
Resistance temperature detector	Pt100	100°C f.s.	0.01°C	-100°C to 100°C	±0.5°C
		500°C f.s.	0.05°C	-200°C to 500°C	±0.7°C
		2000°C f.s.	0.1°C	-200°C to 800°C	±0.9°C
	JPt100	100°C f.s.	0.01°C	-100°C to 100°C	±0.5°C
		500°C f.s.	0.05°C	-200°C to 500°C	±0.7°C
		2000°C f.s.	0.1°C	-200°C to 500°C	±0.9°C
	Pt1000	100°C f.s.	0.01°C	-100°C to 100°C	±0.5°C
		500°C f.s.	0.05°C	-200°C to 500°C	±0.7°C
		2000°C f.s.	0.1°C	-200°C to 800°C	±0.9°C
Resistance	-	10 Ω f.s.	0.5 mΩ	0 Ω to 10 Ω	±10 mΩ
		20 Ω f.s.	1 mΩ	0 Ω to 20 Ω	±20 mΩ
		100 Ω f.s.	5 mΩ	0 Ω to 100 Ω	±100 mΩ
		200 Ω f.s.	10 mΩ	0 Ω to 200 Ω	±200 mΩ

Accuracy of reference junction compensation	±0.5°C (with input terminal temperature balancing) Reference junction compensation: Add thermocouple measurement accuracy when set to <i>internal</i> .
Temperature characteristics	Add (measurement accuracy × 0.1) per degree (for humidity, see humidity accuracy table).
Normal mode rejection ratio	50 dB or greater (With 50 Hz input, power supply frequency filter of 50 Hz, and a data refresh interval of 5 s) (With 60 Hz input, power supply frequency filter of 60 Hz, and a data refresh interval of 5 s) (With thermocouple wire break detection disabled)
Common mode rejection ratio	Signal source resistance of 100 Ω or less 100 dB or greater (With 50 Hz/60 Hz input and a data refresh interval of 10 ms) 140 dB or greater (With 50 Hz input, power supply frequency filter of 50 Hz, and a data refresh interval of 5 s in the 10 mV f.s. range) (With 60 Hz input, power supply frequency filter of 60 Hz, and a data refresh interval of 5 s in the 10 mV f.s. range) (With thermocouple wire break detection disabled)
Effect of radiated radio-frequency electromagnetic field	±5% f.s. (80 MHz to 1 GHz: 10 V/m; 1 GHz to 6 GHz: 3 V/m) (Pt100 resistance temperature detector, 100°C f.s. range, 4-wire connection)
Effect of conducted radio-frequency electromagnetic field	±5% f.s. at 10 V (Pt100 resistance temperature detector, 100°C f.s. range, 4-wire setup)

U8552 Voltage/Temp Unit

1. General specifications

Compatible logger	LR8450/LR8450-01 Memory HiLogger
Operating environment	Indoors, Pollution Degree 2, altitude up to 2000 m (6562 ft.)
Operating temperature and humidity range	-10°C to 50°C (14°F to 122°F), 80% RH or less (non-condensing)
Storage temperature and humidity range	-20°C to 60°C (-4°F to 140°F), 80% RH or less (non-condensing)
Standards	Safety: EN 61010 EMC: EN 61326, Class A
Standard compliance	Thermocouples: JIS C1602:2015, IEC 60584-1:2013
Vibration resistance	JIS D 1601:1995 5.3 (1) Class 1: Passenger vehicles; conditions: Class A equivalent (4 h along X-axis and 2 h along Y- and Z-axes at a vibration acceleration of 45 m/s ² [4.6 G])
Dimensions	Approx. 134W × 70H × 63D mm (5.28"W × 2.76"H × 2.48"D) (including cover)
Mass	Approx. 319 g (11.3 oz.)
Product warranty period	3 years
Accessories	Instruction Manual Installation screws × 2
Options	Z2000 Humidity Sensor

2. Input, output, and measurement specifications

-1. Basic specifications

Number of input channels	30 (Set voltage, thermocouple, or humidity for each channel.)
Input terminals	Push-button type terminal block (2 terminals per channel), outfitted with terminal block cover
Measurement target	Voltage Thermocouples (K, J, E, T, N, R, S, B, C) Humidity (using the Z2000 Humidity Sensor)
Input type	Scanning by semiconductor relays, floating unbalanced input All channels isolated
A/D resolution	16 bits
Maximum input voltage	±100 V DC
Maximum channel-to-channel voltage	300 V DC
Maximum rated terminal-to-ground voltage	300 V AC, DC (Measurement Category II) Between any input channel (+, -) and the instrument (LR8450/LR8450-01) or between any two modules Anticipated transient overvoltage: 2500 V
Input resistance	10 MΩ or greater (10 mV f.s. to 2 V f.s. voltage ranges, all thermocouple ranges) 1 MΩ ±5% (10 V f.s. to 100 V f.s. voltage range, 1-5 V f.s. voltage range, humidity range)
Allowable signal source resistance	1 kΩ or less

Reference junction compensation	Internal/external (user-selectable) (during thermocouple measurement)
Thermocouple wire break detection	The system will check for wire breaks each date refresh interval during thermocouple measurement. On/Off (user-selectable) (set for entire module) Detection current: 5 μ A \pm 20% (No current flows while acquiring measurement data.) Setting not available when the data refresh interval is set to 10 ms. Setting not available when the data refresh interval is set to 20 ms and 16 or more channels are being used.
Data refresh interval	10 ms ^{*1} , 20 ms ^{*2} , 50 ms, 100 ms, 200 ms, 500 ms, 1 s, 2 s, 5 s, 10 s ^{*1} : Setting available when thermocouple wire break detection is disabled and the number of channels in use ranges from 1 to 15. ^{*2} : Setting available when thermocouple wire break detection is disabled and the number of channels in use ranges from 16 to 30. Alternatively, setting available when thermocouple wire break detection is enabled and the number of channels in use ranges from 1 to 15.

Digital filters The digital filter cutoff frequency is automatically set as described in the following table according to the number of channels in use, data refresh interval, Wire break detection setting, and power supply frequency filter setting:

(1) When the number of channels in use is 15 or less

–: Setting not available

Power supply frequency filter setting	Wire break detection setting	Data refresh interval									
		10 ms	20 ms	50 ms	100 ms	200 ms	500 ms	1 s	2 s	5 s	10 s
60 Hz	Off	20.8 k	6.94 k	2.98 k	2.37 k	739	60	60	60	60	60
	On	–	20.8 k	6.94 k	2.98 k	2.37 k	739	60	60	60	60
50 Hz	Off	20.8 k	6.94 k	2.98 k	2.37 k	739	50	50	50	50	50
	On	–	20.8 k	6.94 k	2.98 k	2.37 k	739	50	50	50	50

Unit: Hz

(2) When the number of channels in use is 16 to 30

–: Setting not available

Power supply frequency filter setting	Wire break detection setting	Data refresh interval									
		10 ms	20 ms	50 ms	100 ms	200 ms	500 ms	1 s	2 s	5 s	10 s
60 Hz	Off	–	20.8 k	6.94 k	2.98 k	2.37 k	739	60	60	60	60
	On	–	–	20.8 k	6.94 k	2.98 k	2.37 k	739	60	60	60
50 Hz	Off	–	20.8 k	6.94 k	2.98 k	2.37 k	739	50	50	50	50
	On	–	–	20.8 k	6.94 k	2.98 k	2.37 k	739	50	50	50

Unit: Hz

-2. Accuracy specifications

Accuracy guarantee conditions	Accuracy guarantee period	1 year
	Accuracy guarantee period after adjustment made by Hioki	1 year
	Accuracy guarantee temperature and humidity range	23°C ±5°C (73°F±9°F), 80% RH or less
	Warm-up time	At least 30 min. after connecting to the LR8450/LR8450-01 Memory HiLogger and turning on the instrument
The conditions have been specified with zero-adjustment finished and cutoff frequency set to 50 Hz/60 Hz (see cutoff frequency table in "Digital filters" [p.256]).		

Measurement range, maximum resolution, measurable range, and measurement accuracy figures

Measurement target	Type	Range	Maximum resolution	Measurable range	Measurement accuracy
Voltage	-	10 mV f.s.	500 nV	-10 mV to 10 mV	±10 µV
		20 mV f.s.	1 µV	-20 mV to 20 mV	±20 µV
		100 mV f.s.	5 µV	-100 mV to 100 mV	±50 µV
		200 mV f.s.	10 µV	-200 mV to 200 mV	±100 µV
		1 V f.s.	50 µV	-1 V to 1 V	±500 µV
		2 V f.s.	100 µV	-2 V to 2 V	±1 mV
		10 V f.s.	500 µV	-10 V to 10 V	±5 mV
		20 V f.s.	1 mV	-20 V to 20 V	±10 mV
		100 V f.s.	5 mV	-100 V to 100 V	±50 mV
		1-5 V f.s.	500 µV	1 V to 5 V	±5 mV
Thermocouple (Not including accuracy of reference junction compensation)	K	100°C f.s.	0.01°C	Greater than or equal to -100°C and less than 0°C	±0.7°C
				Greater than or equal to 0°C and less than or equal to 100°C	±0.5°C
		500°C f.s.	0.05°C	Greater than or equal to -200°C and less than -100°C	±1.4°C
				Greater than or equal to -100°C and less than 0°C	±0.7°C
				Greater than or equal to 0°C and less than or equal to 500°C	±0.5°C
		2000°C f.s.	0.1°C	Greater than or equal to -200°C and less than -100°C	±1.4°C
				Greater than or equal to -100°C and less than 0°C	±0.7°C
				Greater than or equal to 0°C and less than 500°C	±0.5°C
	Greater than or equal to 500°C and less than or equal to 1350°C			±0.7°C	
	J	100°C f.s.	0.01°C	Greater than or equal to -100°C and less than 0°C	±0.7°C
				Greater than or equal to 0°C and less than or equal to 100°C	±0.5°C
		500°C f.s.	0.05°C	Greater than or equal to -200°C and less than -100°C	±0.9°C
				Greater than or equal to -100°C and less than 0°C	±0.7°C
				Greater than or equal to 0°C and less than or equal to 500°C	±0.5°C
		2000°C f.s.	0.1°C	Greater than or equal to -200°C and less than -100°C	±0.9°C
				Greater than or equal to -100°C and less than 0°C	±0.7°C
Greater than or equal to 0°C and less than or equal to 1200°C				±0.5°C	

Measurement target	Type	Range	Maximum resolution	Measurable range	Measurement accuracy
Thermocouple (Not including accuracy of reference junction compensation)	E	100°C f.s.	0.01°C	Greater than or equal to -100°C and less than 0°C	±0.7°C
				Greater than or equal to 0°C and less than or equal to 100°C	±0.5°C
		500°C f.s.	0.05°C	Greater than or equal to -200°C and less than -100°C	±0.9°C
				Greater than or equal to -100°C and less than 0°C	±0.7°C
				Greater than or equal to 0°C and less than or equal to 500°C	±0.5°C
		2000°C f.s.	0.1°C	Greater than or equal to -200°C and less than -100°C	±0.9°C
				Greater than or equal to -100°C and less than 0°C	±0.7°C
				Greater than or equal to 0°C and less than or equal to 1000°C	±0.5°C
		T	100°C f.s.	0.01°C	Greater than or equal to -100°C and less than 0°C
	Greater than or equal to 0°C and less than or equal to 100°C				±0.5°C
	500°C f.s.		0.05°C	Greater than or equal to -200°C and less than -100°C	±1.4°C
				Greater than or equal to -100°C and less than 0°C	±0.7°C
				Greater than or equal to 0°C and less than or equal to 400°C	±0.5°C
	2000°C f.s.		0.1°C	Greater than or equal to -200°C and less than -100°C	±1.4°C
				Greater than or equal to -100°C and less than 0°C	±0.7°C
				Greater than or equal to 0°C and less than or equal to 400°C	±0.5°C
	N		100°C f.s.	0.01°C	Greater than or equal to -100°C and less than 0°C
		Greater than or equal to 0°C and less than or equal to 100°C			±0.9°C
		500°C f.s.	0.05°C	Greater than or equal to -200°C and less than -100°C	±2.1°C
				Greater than or equal to -100°C and less than 0°C	±1.1°C
				Greater than or equal to 0°C and less than or equal to 500°C	±0.9°C
2000°C f.s.		0.1°C	Greater than or equal to -200°C and less than -100°C	±2.1°C	
			Greater than or equal to -100°C and less than 0°C	±1.1°C	
			Greater than or equal to 0°C and less than or equal to 1300°C	±0.9°C	

Measurement target	Type	Range	Maximum resolution	Measurable range	Measurement accuracy		
Thermocouple (Not including accuracy of reference junction compensation)	R	100°C f.s.	0.01°C	0°C to 100°C	±4.4°C		
				500°C f.s.	0.05°C	Greater than or equal to 0°C and less than 100°C	±4.4°C
						Greater than or equal to 100°C and less than 300°C	±2.9°C
		Greater than or equal to 300°C and less than or equal to 500°C	±2.2°C				
		2000°C f.s.	0.1°C	Greater than or equal to 0°C and less than 100°C	±4.4°C		
					Greater than or equal to 100°C and less than 300°C	±2.9°C	
					Greater than or equal to 300°C and less than or equal to 1700°C	±2.2°C	
				Greater than or equal to 0°C and less than or equal to 100°C	±4.4°C		
					Greater than or equal to 100°C and less than 300°C	±2.9°C	
	Greater than or equal to 300°C and less than or equal to 500°C				±2.2°C		
	S	100°C f.s.	0.01°C	Greater than or equal to 0°C and less than or equal to 100°C	±4.4°C		
				500°C f.s.	0.05°C	Greater than or equal to 0°C and less than 100°C	±4.4°C
						Greater than or equal to 100°C and less than 300°C	±2.9°C
		Greater than or equal to 300°C and less than or equal to 500°C	±2.2°C				
		2000°C f.s.	0.1°C	Greater than or equal to 0°C and less than 100°C	±4.4°C		
					Greater than or equal to 100°C and less than 300°C	±2.9°C	
					Greater than or equal to 300°C and less than or equal to 1700°C	±2.2°C	
				Greater than or equal to 400°C and less than 600°C	±5.4°C		
					Greater than or equal to 600°C and less than 1000°C	±3.7°C	
	Greater than or equal to 1000°C and less than or equal to 1800°C				±2.4°C		
	C	100°C f.s.	0.01°C	0°C to 100°C	±1.7°C		
500°C f.s.				0.05°C	0°C to 500°C	±1.7°C	
					2000°C f.s.	0.1°C	0°C to 2000°C

Measurement target	Type	Range	Maximum resolution	Measurable range	Measurement accuracy
Humidity	–	100% RH f.s.	0.1% RH	5.0% RH to 95.0% RH	As per measurement accuracy of the Z2000 Humidity Sensor

Accuracy of reference junction compensation	±0.5°C (with input terminal temperature balancing) Reference junction compensation: Add thermocouple measurement accuracy when set to <i>internal</i> .
Temperature characteristics	Add (measurement accuracy × 0.1) per degree (for humidity, see humidity accuracy table).
Normal mode rejection ratio	50 dB or greater (With 50 Hz input, power supply frequency filter of 50 Hz, and a data refresh interval of 5 s) (With 60 Hz input, power supply frequency filter of 60 Hz, and a data refresh interval of 5 s) (With thermocouple wire break detection disabled and 15 or fewer channels in use)
Common mode rejection ratio	Signal source resistance of 100 Ω or less 100 dB or greater (With 50 Hz/60 Hz input and a data refresh interval of 10 ms) 140 dB or greater (With 50 Hz input, power supply frequency filter of 50 Hz, and a data refresh interval of 5 s in the 10 mV f.s. range) (With 60 Hz input, power supply frequency filter of 60 Hz, and a data refresh interval of 5 s in the 10 mV f.s. range) (With thermocouple wire break detection disabled and 15 or fewer channels in use)
Effect of radiated radio-frequency electromagnetic field	±5% f.s. (80 MHz to 1 GHz: 10 V/m; 1 GHz to 6 GHz: 3 V/m) (in the 10 V f.s. voltage range)
Effect of conducted radio-frequency electromagnetic field	±5% f.s. at 10 V (in the 10 V f.s. voltage range)

U8553 High Speed Voltage Unit

1. General specifications

Compatible logger	LR8450/LR8450-01 Memory HiLogger
Operating environment	Indoors, Pollution Degree 2, altitude up to 2000 m (6562 ft.)
Operating temperature and humidity range	-10°C to 50°C (14°F to 122°F), 80% RH or less (non-condensing)
Storage temperature and humidity range	-20°C to 60°C (-4°F to 140°F), 80% RH or less (non-condensing)
Standards	Safety: EN 61010 EMC: EN 61326, Class A
Vibration resistance	JIS D 1601:1995 5.3 (1) Class 1: Passenger vehicles; conditions: Class A equivalent (4 h along X-axis and 2 h along Y- and Z-axes at a vibration acceleration of 45 m/s ² [4.6 G])
Dimensions	Approx. 134W × 70H × 63D mm (5.28"W × 2.76"H × 2.48"D) (including cover)
Mass	Approx. 237 g (8.4 oz.)
Product warranty period	3 years
Accessories	Instruction Manual Installation screws × 2

2. Input and measurement specifications

-1. Basic specifications

Number of input channels	5 (voltage only)
Input terminals	M3 screw-type terminal block (2 terminals per channel), outfitted with terminal block cover
Measurement target	Voltage
Input type	Scanning by semiconductor relays, floating unbalanced input All channels isolated
A/D resolution	16 bits
Maximum input voltage	±100 V DC
Maximum channel-to-channel voltage	300 V DC
Maximum rated terminal-to-ground voltage	300 V AC, DC (Measurement Category II) Between any input channel (+, -) and the instrument (LR8450/LR8450-01) or between any two modules Anticipated transient overvoltage: 2500 V
Input resistance	1 MΩ ±5%
Allowable signal source resistance	100 Ω or less
Data refresh interval	1 ms, 2 ms, 5 ms, 10 ms, 20 ms, 50 ms, 100 ms, 200 ms, 500 ms, 1 s, 2 s, 5 s, 10 s

Digital filters The digital filter cutoff frequency is automatically set as described in the following table according to the data refresh interval and power supply frequency filter setting:

Power supply frequency filter setting	Data refresh interval												
	1 ms	2 ms	5 ms	10 ms	20 ms	50 ms	100 ms	200 ms	500 ms	1 s	2 s	5 s	10 s
60 Hz	50 k	5 k	2.6 k	1.0 k	400	200	100	60	60	10	5	5	5
50 Hz	50 k	5 k	2.6 k	1.0 k	400	200	100	50	50	10	5	5	5

Unit: Hz

-2. Accuracy specifications

Accuracy guarantee conditions	Accuracy guarantee period	1 year
	Accuracy guarantee period after adjustment made by Hioki	1 year
	Accuracy guarantee temperature and humidity range	23°C ±5°C (73°F±9°F), 80% RH or less
	Warm-up time	At least 30 min. after connecting to the LR8450/LR8450-01 Memory HiLogger and turning on the instrument

The conditions have been specified with zero-adjustment finished and cutoff frequency set to 5 Hz, 10 Hz, 50 Hz, or 60 Hz (see cutoff frequency table in “Digital filters” [p.263]).

Measurement range, maximum resolution, measurable range, and measurement accuracy figures

Measurement target	Type	Range	Maximum resolution	Measurable range	Measurement accuracy
Voltage	-	100 mV f.s.	5 µV	-100 mV to 100 mV	±100 µV
		200 mV f.s.	10 µV	-200 mV to 200 mV	±200 µV
		1 V f.s.	50 µV	-1 V to 1 V	±1 mV
		2 V f.s.	100 µV	-2 V to 2 V	±2 mV
		10 V f.s.	500 µV	-10 V to 10 V	±10 mV
		20 V f.s.	1 mV	-20 V to 20 V	±20 mV
		100 V f.s.	5 mV	-100 V to 100 V	±100 mV
		1-5 V f.s.	500 µV	1 V to 5 V	±10 mV

Temperature characteristics Add (measurement accuracy × 0.1) per degree.

Normal mode rejection ratio 50 dB or greater
 (With 50 Hz input, power supply frequency filter of 50 Hz, and a data refresh interval of 5 s)
 (With 60 Hz input, power supply frequency filter of 60 Hz, and a data refresh interval of 5 s)

Common mode rejection ratio Signal source resistance of 100 Ω or less
 100 dB or greater
 (With 50 Hz/60 Hz input and a data refresh interval of 1 ms)
 140 dB or greater
 (With 50 Hz input, power supply frequency filter of 50 Hz, and a data refresh interval of 5 s in the 100 mV f.s. range)
 (With 60 Hz input, power supply frequency filter of 60 Hz, and a data refresh interval of 5 s in the 100 mV f.s. range)

Effect of radiated radio-frequency electromagnetic field	$\pm 5\%$ f.s. (80 MHz to 1 GHz: 10 V/m; 1 GHz to 6 GHz: 3 V/m) (in the 10 V f.s. voltage range)
---	--

Effect of conducted radio-frequency electromagnetic field	$\pm 5\%$ f.s. at 10 V (in the 10 V f.s. voltage range)
--	---

U8554 Strain Unit

1. General specifications

Compatible logger	LR8450/LR8450-01 Memory HiLogger
Operating environment	Indoors, Pollution Degree 2, altitude up to 2000 m (6562 ft.)
Operating temperature and humidity range	-10°C to 50°C (14°F to 122°F), 80% RH or less (non-condensing)
Storage temperature and humidity range	-20°C to 60°C (-4°F to 140°F), 80% RH or less (non-condensing)
Standards	Safety: EN 61010 EMC: EN 61326, Class A
Vibration resistance	JIS D 1601:1995 5.3 (1) Class 1: Passenger vehicles; conditions: Class A equivalent (4 h along X-axis and 2 h along Y- and Z-axes at a vibration acceleration of 45 m/s ² [4.6 G])
Dimensions	Approx. 134W × 70H × 63D mm (5.28"W × 2.76"H × 2.48"D) (including cover)
Mass	Approx. 236 g (8.3 oz.)
Product warranty period	3 years
Accessories	Instruction Manual Installation screws × 2 Connection confirmation label

2. Input, output, and measurement specifications

-1. Basic specifications

Number of input channels	5 (Set voltage or strain for each channel.)	
Input terminals	Push-button type terminal block (5 terminals per channel), outfitted with terminal block cover Set DIP switches according to measurement target.	
Measurement target	Voltage	
	Strain	Strain gage-type converter Strain gage 1-gage method (2-wire setup), 1-gage method (3-wire setup), 2-gage method (adjacent sides), 4-gage method
Adaptive gage resistance	1-gage method, 2-gage method: 120 Ω (external bridge box required for 350 Ω) 4-gage method: 120 Ω to 1 kΩ	
Gage factor	Fixed to 2.0	
Bridge voltage	2 V ±0.05 V DC	
Balance adjustment	Method	Electronic auto-balancing
	Range	Voltage: ±20 mV or less (1 mV f.s. to 20 mV f.s. range), ±200 mV or less (50 mV f.s. to 200 mV f.s. range) Strain: ±20,000 με or less (1000 με f.s. to 20,000 με f.s. range), ±200,000 με or less (50,000 με f.s. to 200,000 με f.s. range)
Input type	Balanced differential input, non-isolated channels, simultaneous sampling of all channels	
A/D resolution	16 bits	
Maximum input voltage	±0.5 V DC	

Maximum channel-to-channel voltage	Non-isolated (all channels share common GND)											
Maximum rated terminal-to-ground voltage	30 V rms AC or 60 V DC (between analog input channels and the instrument [LR8450/LR8450-01]) Anticipated transient overvoltage: 330 V											
Input resistance	2 MΩ ±5%											
Data refresh interval	1 ms, 2 ms, 5 ms, 10 ms, 20 ms, 50 ms, 100 ms, 200 ms, 500 ms, 1 s, 2 s, 5 s, 10 s											
Low-pass filter	Cutoff frequency -3 dB ±30%	Auto, 120, 60, 30, 15, 8, 4 (Hz) Auto: The low-pass filter's cutoff frequency is automatically set as described in the following table based on the set data refresh interval:										
Data refresh interval												
1 ms	2 ms	5 ms	10 ms	20 ms	50 ms	100 ms	200 ms	500 ms	1 s	2 s	5 s	10 s
120 Hz	60 Hz	30 Hz	15 Hz	8 Hz	4 Hz	4 Hz	4 Hz	4 Hz	4 Hz	4 Hz	4 Hz	4 Hz
		Attenuation characteristics										
		5th-order Butterworth filter, -30 dB/oct										

-2. Accuracy specifications

Accuracy guarantee conditions	Accuracy guarantee period	1 year
	Accuracy guarantee period after adjustment made by Hioki	1 year
	Accuracy guarantee temperature and humidity range	23°C ±5°C (73°F±9°F), 80% RH or less
	Warm-up time	At least 30 min. after connecting to the LR8450/LR8450-01 Memory HiLogger and turning on the instrument
The conditions have been specified with auto-balance finished and the low-pass filter set to 4 kHz.		

Measurement range, maximum resolution, measurable range, and measurement accuracy figures

Measurement target	Range	Maximum resolution	Measurable range	Measurement accuracy*
Voltage	1 mV f.s.	50 nV	-1 mV to 1 mV	±9 µV
	2 mV f.s.	100 nV	-2 mV to 2 mV	±10 µV
	5 mV f.s.	250 nV	-5 mV to 5 mV	±25 µV
	10 mV f.s.	500 nV	-10 mV to 10 mV	±50 µV
	20 mV f.s.	1 µV	-20 mV to 20 mV	±100 µV
	50 mV f.s.	2.5 µV	-50 mV to 50 mV	±250 µV
	100 mV f.s.	5 µV	-100 mV to 100 mV	±500 µV
	200 mV f.s.	10 µV	-200 mV to 200 mV	±1 mV
Strain	1,000 µε f.s.	0.05 µε	-1,000 µε to 1,000 µε	±9 µε
	2,000 µε f.s.	0.1 µε	-2,000 µε to 2,000 µε	±10 µε
	5,000 µε f.s.	0.25 µε	-5,000 µε to 5,000 µε	±25 µε
	10,000 µε f.s.	0.5 µε	-10,000 µε to 10,000 µε	±50 µε
	20,000 µε f.s.	1 µε	-20,000 µε to 20,000 µε	±100 µε
	50,000 µε f.s.	2.5 µε	-50,000 µε to 50,000 µε	±250 µε
	100,000 µε f.s.	5 µε	-100,000 µε to 100,000 µε	±500 µε
	200,000 µε f.s.	10 µε	-200,000 µε to 200,000 µε	±1000 µε

Temperature characteristics*

Gain ±0.05% f.s. per °C
 Zero position
 Voltage: ±1.5 µV per °C
 Strain: ±1.5 µε per °C

Built-in bridge resistance precision

Tolerance: ±0.01%
 Temperature characteristics: ±2 ppm per °C

Common mode rejection ratio

100 dB or greater with a signal source resistance of 300 Ω or less (for 50 Hz/60 Hz input)

Effect of radiated radio-frequency electromagnetic field

±50% f.s.
 (80 MHz to 1 GHz: 10 V/m; 1 GHz to 6 GHz: 3 V/m)
 (in the 5000 µε f.s. strain range with low-pass filter enabled at 4 Hz)

Effect of conducted radio-frequency electromagnetic field

±5% f.s. at 10 V
 (in the 5000 µε f.s. strain range with low-pass filter enabled at 4 Hz)

*: Does not include built-in bridge resistance tolerance and temperature characteristics.

11.1 Measuring Temperature

This section provides precautionary information related to thermocouples, which are widely used to measure temperature.

Choosing the right thermocouple

The following thermocouples can be used with the instrument:

Thermocouple	Temperature range for which tolerance is defined by JIS C 1602 (°C)	Characteristics
K	-40 to 1200	Has a linear relationship between temperature and thermal electromotive force; the most widely used in industrial applications.
J	-40 to 750	Has the second-highest electromotive force per degree of temperature, after E thermocouples.
E	-40 to 900	Has the highest thermal electromotive force per degree of temperature, which allows effects of noise to be reduced.
T	-40 to 350	Has high electromotive force in the low-temperature domain (-40°C to 350°C). Is used to make precise measurements in the low-temperature domain.
N	-40 to 1200	Exhibits stable thermal electromotive force from low to high temperatures. Is used to make measurements in the high-temperature domain at low cost.
R	0 to 1600	Is used to make measurements in the high-temperature domain. Offers excellent oxidation and chemical resistance, but at high cost.
S		
B	600 to 1700	Is used to make measurements in higher temperature domains than R and S thermocouples. Cannot make measurements in the low- and medium-temperature domain due to its extremely low electromotive force.
C	426 to 2315	Can make measurements at the highest temperatures.

K and E thermocouples exhibit a physical phenomenon known as short range ordering in which thermal electromotive force increases gradually from 250°C to 600°C, producing a large error in a comparatively short period of time (1 hr. or less). This unavoidable phenomenon is caused by the device's physical characteristics. Once a thermocouple's thermal electromotive force has increased, it will not return to its normal value, even if the temperature falls. In order to return to the original thermal electromotive force curve, the temperature must rise to at least 650°C.

Choose the appropriate thermocouple after checking with the manufacturer.

Error caused by thermocouple heat dissipation

When a thermocouple is applied to a surface, heat dissipates (is conducted) from the measurement target via the thermocouple. If a large amount of heat is conducted to the thermocouple, the reading will be lower than the actual temperature.

Of K and T thermocouples, the latter is characterized by higher heat dissipation due to its superior thermal conductivity.

The larger the thermocouple's diameter, the greater its heat dissipation.

When measuring the temperature of small components, it is recommended to use a small-diameter K thermocouple.

Ensuring the thermocouple is securely affixed to the measurement target

To measure temperature with a high degree of precision, ensure that the tip of the thermocouple is securely affixed to the measurement target.

If there is little contact between the tip of the thermocouple and the measurement target, little heat will be conducted to the thermocouple, resulting in a reading that is lower than the actual temperature.

When measuring a large measurement target, you can reduce the amount of heat dissipated from the thermocouple by ensuring that more than just the tip of the thermocouple is in contact with the measurement target.

11.2 Measuring Strain

Tension and compression on a single axis

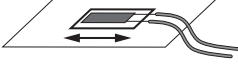
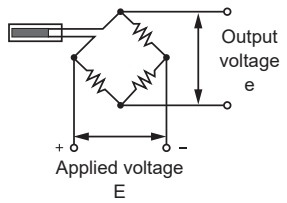
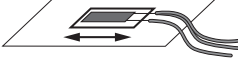
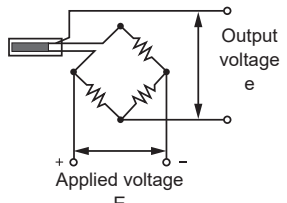
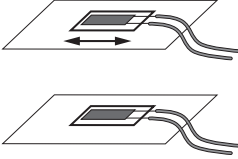
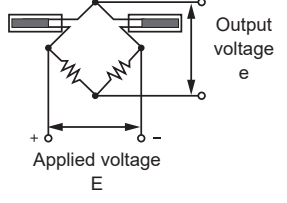
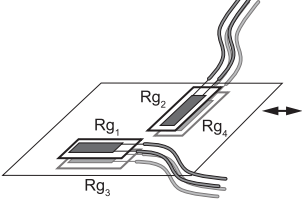
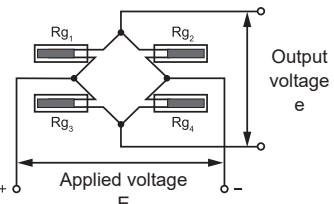
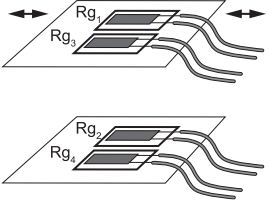
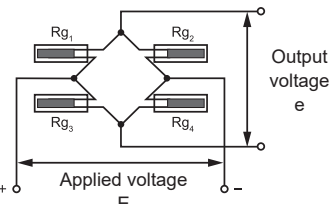
Gage method	Bridge circuit diagram	Output	Remarks
1-gage method (2-wire)* ¹ 		$e = \varepsilon$ ε : Strain	This is the most typical connection method.
1-gage method (3-wire)* ¹ 			This connection method cancels the effects of temperature on the strain gage wiring.
2-gage method (adjacent side) (active dummy method)* ¹ 			In this connection method, a reference strain gage is affixed to a specimen made of the same material as the measurement target that is not being subjected to stress. Apparent strain resulting from temperature changes is measured using the reference gage and canceled out.
4-gage method (perpendicular placement) 		$e = 2(1 + \text{Poisson's ratio}) \times \varepsilon$	This connection method cancels the effects of temperature changes of the measurement target. Use the scaling conversion ratio slope described below. $1 / \{2 \times (1 + \text{Poisson's ratio})\}$
4-gage method (active dummy method) 		$e = 2\varepsilon$	This connection method is not affected by temperature changes of the measurement target or bending strain. * ²

*1: Must be corrected using $(1,000,000 \times \text{measured value}) / (1,000,000 - \text{measured value})$. The scaling function cannot be used to perform correction. Instead, perform correction using the waveform calculation function.

Example: True strain value if the instrument measures a strain value of 50,000 $\mu\epsilon$ while using the 1-gage/2-wire method

$$\epsilon_i = \frac{(1,000,000 \times \epsilon)}{(1,000,000 - \epsilon)} = \frac{(1,000,000 \times 50,000)}{(1,000,000 - 50,000)} = \frac{50,000 \times 10^6}{950,000} \approx 52632 (\mu\epsilon)$$

ϵ_i : True strain value
 ϵ : Strain value measured by instrument

*2: Must be corrected using $(2,000,000 \times \text{measured value}) / (4,000,000 - 2 \times \text{measured value})$. The scaling function cannot be used to perform correction. Instead, perform correction using the waveform calculation function.

Example: True strain value if the instrument measures a strain value of 100,000 $\mu\epsilon$ while using the active dummy (4-wire) method

$$\epsilon_i = \frac{(2,000,000 \times \epsilon)}{(4,000,000 - 2 \times \epsilon)} = \frac{(2,000,000 \times 100,000)}{(4,000,000 - 2 \times 100,000)} = \frac{200,000 \times 10^6}{3,800,000} \approx 52632 (\mu\epsilon)$$

ϵ_i : True strain value
 ϵ : Strain value measured by instrument

Example waveform calculation settings

For footnote *1

$$W1 = (-1 * U1-1) + 1M$$

$$W2 = (1M * U1-1) / (1 * W1)$$

W2 indicates the calculation result. The above calculations cannot be combined into a single setting.

Bending stress

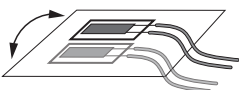
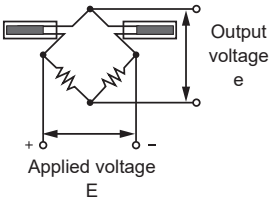
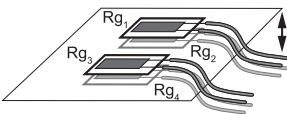
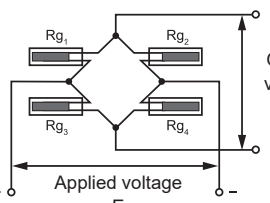
Gage method	Bridge circuit diagram	Output	Remarks
2-gage method (adjacent sides) (bending strain) 		$e = 2\epsilon$	In this connection method, the strain gage is affixed to the top and bottom surfaces. This approach makes it possible to measure bending strain alone, without the effects of tension or compression strain. Use a scaling conversion ratio slope of 1/2.
4-gage method (bending strain) 		$e = 4\epsilon$	This connection method is not affected by temperature changes of the measurement target or tension/compression strain. Use a scaling conversion ratio slope of 1/4.

Torsional stress

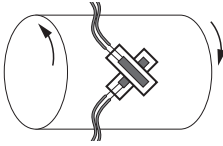
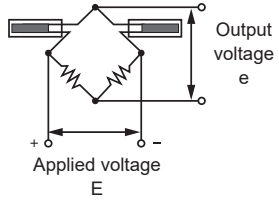
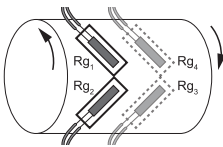
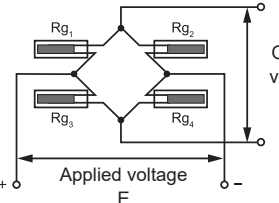
Gage method	Bridge circuit diagram	Output	Remarks
<p>2-gage method (adjacent side) (torsion strain)</p> 		$e = 2\varepsilon$	<p>When measuring strain in the rotational direction, two strain gages are offset so that they intersect at an angle of 90°. Use a scaling conversion ratio slope of $1/2$.</p>
<p>4-gage method (torsion strain)</p> 		$e = 4\varepsilon$	<p>This connection method is not affected by temperature changes of the measurement target or tension/compression/bending strain. Use a scaling conversion ratio slope of $1/4$.</p>



Even in measurements that are affected by temperature, you can compensate for temperature by using a self-temperature-compensated strain gage. Longer wires are more susceptible to the effects of temperature. Long wiring runs make lead wires susceptible to the effects of temperature. You can make measurements with a high degree of precision by using wireless modules to shorten wiring lengths. For information about self temperature-compensated strain gages, contact your strain gage's manufacturer.

Converting values to stress

Multiply Young's modulus by the measured value.

$$\sigma \text{ (stress)} = E \text{ (Young's modulus)} \times \varepsilon \text{ (measured value)}$$

Example: When measuring compression stress

For an aluminum measurement target being measured using the 1-gage method, the following table indicates a Young's modulus value of 73 (GPa).

$$\begin{aligned} \sigma &= 73 \times 10^9 \times \text{measured value} \times 10^{-6} \text{ (measured value unit: } \mu\varepsilon\text{)} \\ &= 73 \times \text{measured value (unit: kPa)} \\ &= 7.44^* \times \text{measured value (unit: gf/mm}^2\text{)} \\ &^*: 1 \text{ Pa} = 1.01971621 \times 10^{-7} \text{ kgf/mm}^2 \end{aligned}$$

Conversion ratio = 7.44; unit: gf/mm²

Set the scaling conversion ratio's slope to this value.

See "1.5 Using the Scaling Function" (p.42).

Mechanical properties of industrial materials

Material	Longitudinal elasticity modulus (Young's modulus) E (GPa)	Poisson's ratio ν
Carbon copper (C 0.1% to 0.25%)	205	0.28 to 0.3
Carbon copper (C >0.25%)	206	0.28 to 0.3
Spring steel (tempered)	206 to 211	0.28 to 0.3
Nickel steel	205	0.28 to 0.3
Cast iron	98	0.2 to 0.29
Brass (cast)	78	0.34
Phosphor bronze	118	0.38
Aluminum	73	0.34
Concrete	20 to 29	0.1

See "1.5 Using the Scaling Function" (p.42).

Auto-balancing

You can execute auto-balance (correcting the input at zero) for strain gage channels.

See p.28.

Correcting for wiring resistance

When using long strain gage wires, measurement is affected by their wiring resistance. True strain values and strain values measured by the instrument are related as shown below. You can use the scaling function to correct strain values. Set the conversion ratio slope to $(R + rL) / R$.

$$\varepsilon_i = \frac{R + rL}{R} \times \varepsilon$$

ε_i : True strain value
 ε : Strain value measured by instrument
 R : Strain gage resistance value (Ω)
 r : Round-trip resistance value per 1 m of wire (Ω/m)
 For 3-wire setup, one-way resistance value (Ω/m)
 L : Wire length (m)

Example settings

If using a strain gage with a wiring length of 5 m and a round-trip resistance value of 0.07 Ω per meter (with a gage resistance of 120 Ω and a gage ratio of 2.00) with a 1-gage method/2-wire connection

$$\varepsilon_i = \frac{120 + 0.07 \times 5}{120} \times \varepsilon = \frac{120.35}{120} \times \varepsilon \approx 1.003 \times \varepsilon$$

ε_i : True strain value
 ε : Strain value measured by instrument

Set the scaling conversion ratio's slope to 1.003.
 See "1.5 Using the Scaling Function" (p.42).

Tips If the instrument (LR8450, -01) and measurement target are located far apart, necessitating long wiring, you can reduce error caused by wiring resistance by placing a Wireless Strain Module (LR8534) close to the measurement target to minimize wiring length.

Correcting for gage factor

If using a strain gage with a gage factor other than 2.0

The U8554 and LR8534 measure strain with a gage factor of 2.0. If using a strain gage with a gage factor other than 2.0, perform the following conversion to set the scaling function's conversion ratio slope:

$$\varepsilon_i = \frac{2.00}{K_a} \times \varepsilon$$

ε_i : True strain value
 ε : Strain value measured by instrument
 K_a : Gage factor of strain gage being used

Example settings

If using a strain gage with a gage factor of 2.10

$$\varepsilon_i = \frac{2.00}{K_a} \times \varepsilon = \frac{2.00}{2.10} \times \varepsilon = 0.952 \times \varepsilon$$

Set the scaling conversion ratio's slope to 0.952.

11.3 Digital filter characteristics

The U8550, U8551, U8552, U8553, LR8530, LR8531, LR8532, and LR8533 have a digital filter. The cutoff frequency is set automatically based on the measurement module type, number of channels in use, data refresh interval, power supply frequency filter, and wire break detection setting.

If you need to reject the power supply's line frequency, you can obtain a high level of noise rejection performance by setting the cutoff frequency so that it matches the power supply's line frequency. For more information about the cutoff frequency, see the sections about individual modules' digital filters in "10.2 Plug-in Module Specifications" (p.243).

The following figures offer a typical example of the digital filter characteristics for the U8550 Voltage/Temp Module when using a data refresh interval of 10 s:

Cutoff frequency: 50 Hz

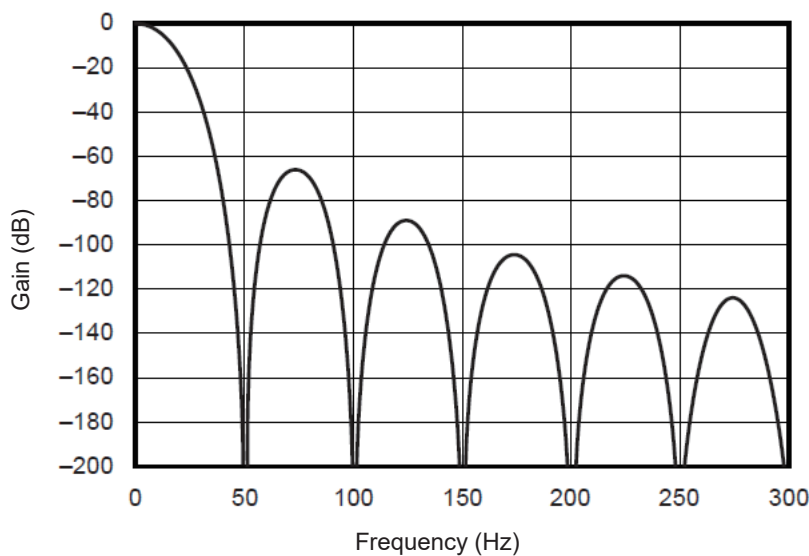

Cutoff frequency: 60 Hz

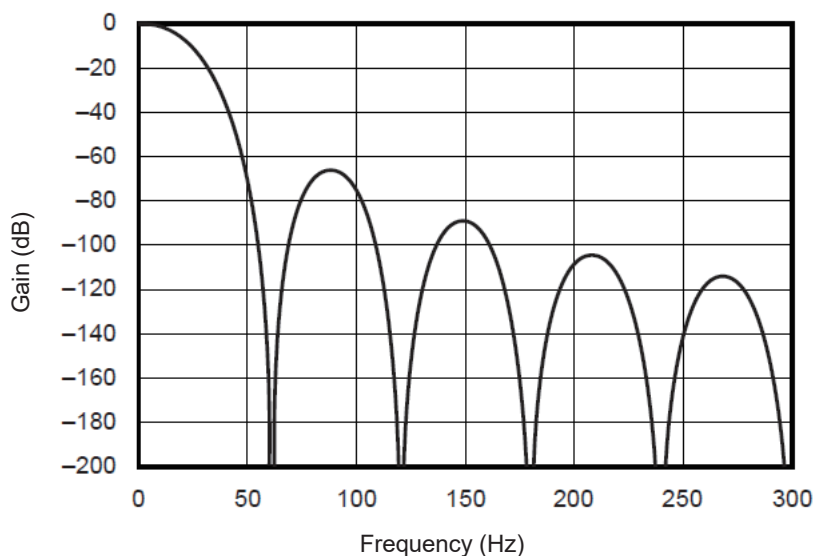

11.4 Noise Countermeasures

This section describes how to deal with a noisy environment.

Noise contamination mechanisms

Noise sources

Manufacturing plants use large currents at 50 Hz/60 Hz as a source of power. Many loads are characterized by an inductive load, for example motors and solenoids. Equipment such as inverters and high-frequency induction furnaces uses capacitor input-type switching power supplies that carry large pulsed currents. Fundamental frequency component leakage currents, harmonic currents, and other components flow together on ground lines.

Noise propagation routes

- Routes by which common-mode voltage between the measurement target and instrument ground leaks to input signal lines
- Routes by which an alternating field is coupled to a loop in the input signal line by the power supply line current
- Routes created by coupling due to capacitance between the input signal lines and power supply lines

Common-mode noise

Noise occurring between the instrument's positive and negative input terminals and ground

Normal-mode noise

Line noise occurring between the instrument's positive and negative input terminals

Example of a connection that is susceptible to the effects of noise

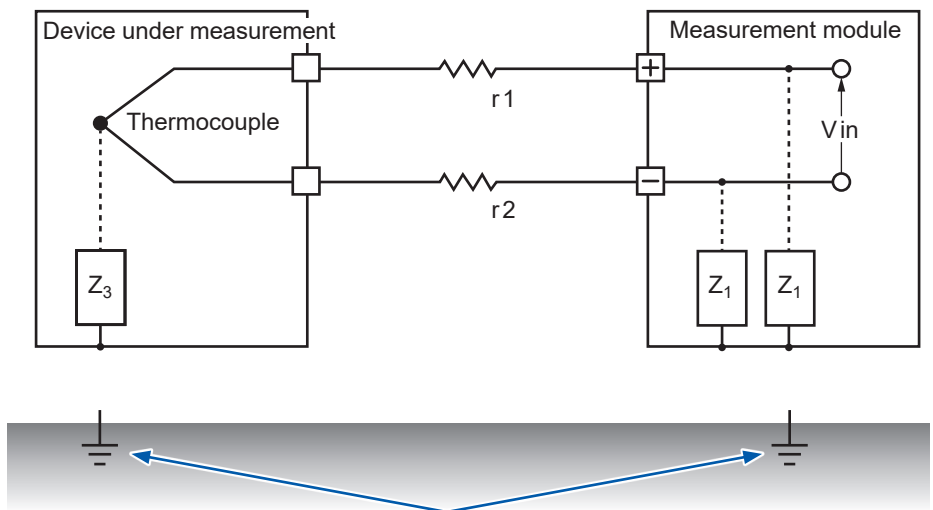

When measuring temperature with a thermocouple, the circuit will be susceptible to noise unless both the device under measurement and the measurement module have been grounded. This is not an issue when powering the measurement module with the battery, but ground the measurement module if using the AC Adapter.

Equivalent circuit for a noise contamination route

Noise such as the following directly affects measured values as normal-mode voltage.

- Electromagnetic induction noise that occurs when an alternating field generated by an inverter or commercial power line is coupled with an instrument's input line loop
- Electrostatic induction noise caused by capacitive coupling between wires

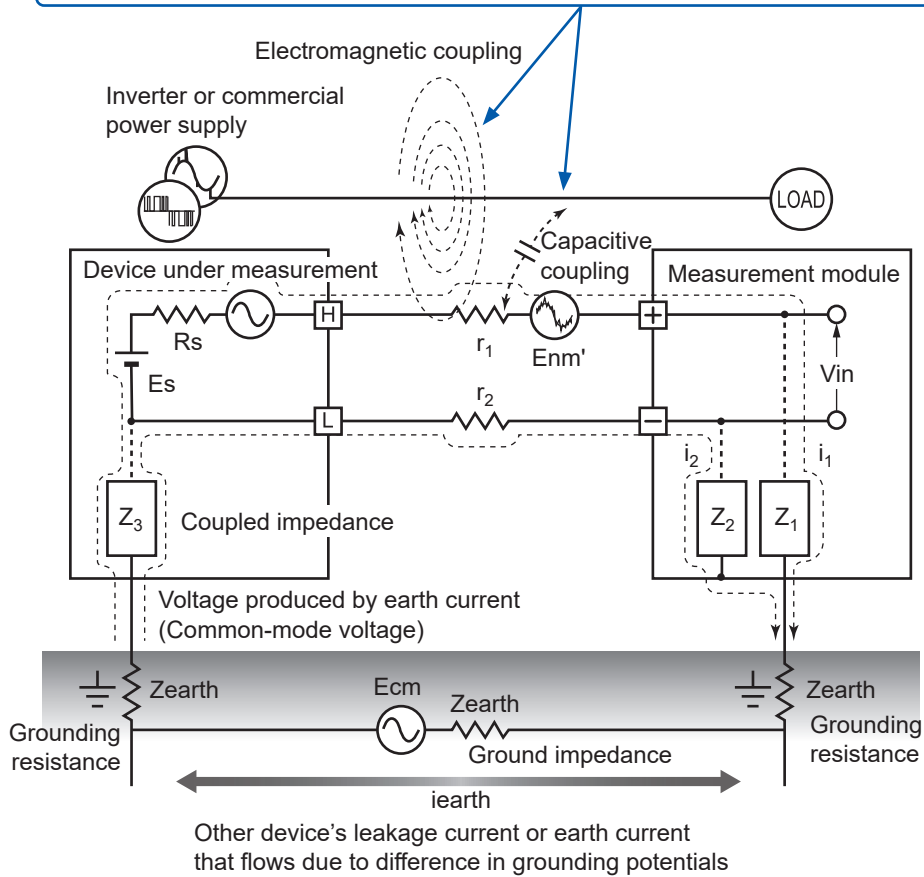

Common-mode noise is caused by ground impedance that is interposed between the ground points of the device under measurement and the measurement module and capacitive coupling between ground lines and noise sources.

Common-mode noise is converted into a normal-mode voltage (E_{nm}) between the instrument's positive and negative input terminals when noise currents (i_1, i_2) flow to coupled impedances (Z_1, Z_2) between the measurement module's positive and negative input terminals and the ground. Since the voltage occurs between the input terminals, measured values are directly affected.

Example noise countermeasures

Ensuring devices are grounded reliably

- Ground the instrument and wireless modules reliably.
You can ground the chassis by connecting the AC Adapter's grounded two-prong power cord to an outlet with a grounding electrode.
- Ensure the measurement target's chassis is grounded reliably.
Ensure the measurement target's chassis is reliably connected to a suitable ground.

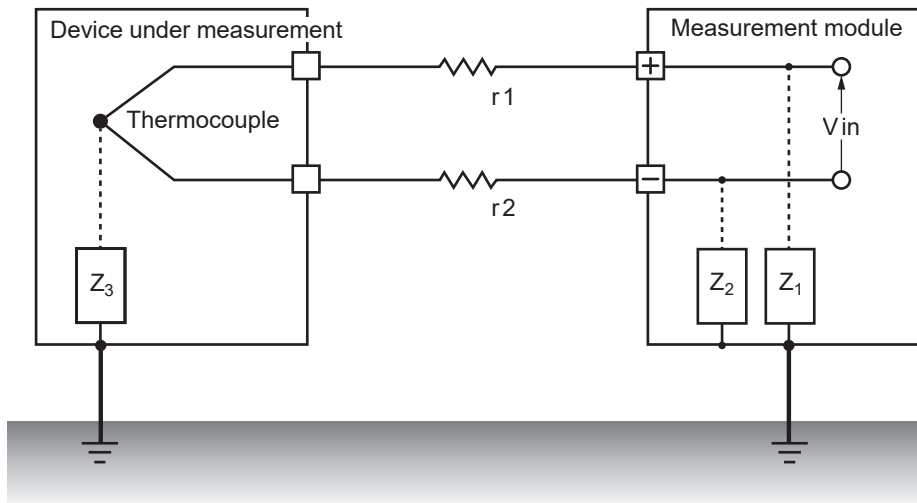

- Power the instrument and wireless modules with batteries.
You can reduce the effects of common-mode noise by powering the devices with batteries (without connecting their AC Adapters) so that the earth current loop is eliminated.

Common-mode noise countermeasures

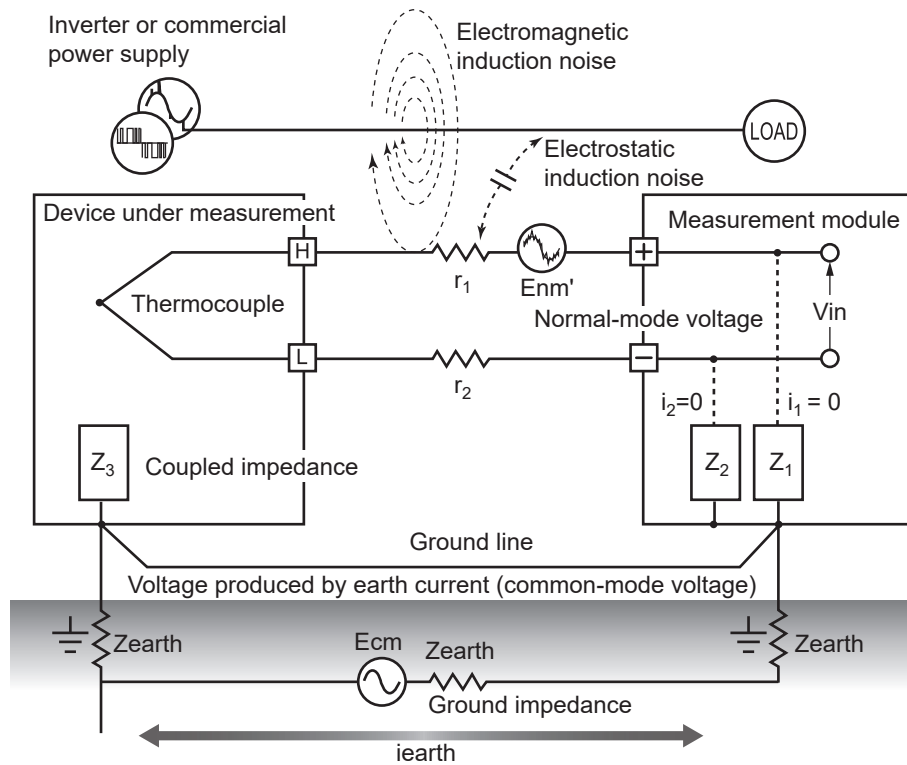

Connect the chassis GND on the signal side to a suitable ground with adequately low grounding resistance.

Either connect to a ground line with low resistance or bypass the grounding electrodes. This will limit the common-mode voltage and reduce noise current (i_1 , i_2). The effect on measured values will be reduced since normal-mode voltage is limited.

Blocking external noise

- Keep signal lines away from noise sources.
Keep input signal lines (thermocouples) away from wires that could serve as sources of noise (power lines, etc.).
Alternatively, install devices so that wires are kept as far apart as possible, for example by running wires through separate ducts.
- Use shielded twisted-pair wire.
One effective way to counteract common-mode noise is to use shielded twisted-pair wires for input signal lines (thermocouples).
Twisted-pair wires prevent electromagnetic induction, while shielded wires prevent electrostatic induction.
Ground shielded wires at the signal source.
For more information about shielded twisted-pair wires for thermocouples, contact the thermocouple manufacturer.

Normal-mode noise countermeasures

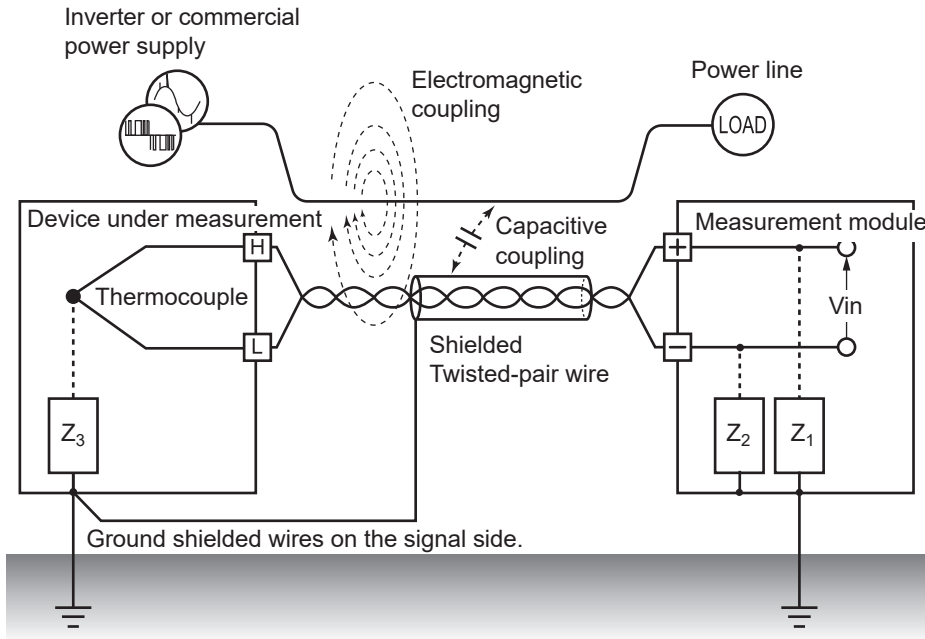

Keep signal lines (thermocouples) away from wires that could serve as sources of noise (power supply lines, etc.). Furthermore, you can block capacitive coupling by shielding and grounding signal lines.

- Isolate circuits from sources of noise (measure temperature using thermocouples).
Input channels are isolated from the enclosure and from each other. You can measure a conductor with a potential by directly affixing a thermocouple, up to the maximum rated terminal-to-ground voltage.
Effective methods for dealing with the effects of noise include wrapping the thermocouple in high-heat-resistance tape to insulate it or isolating input lines with non-grounded thermocouples.
- Use a filter.
You can reject noise that has contaminated input signals by using the power supply frequency filter.
It is recommended to select the same frequency (50 Hz or 60 Hz) as the power supply frequency in the region where the instrument is being used.
See “7.1 Configuring Settings” (p. 164).

The U8554 and LR8534 provide a low-pass filter.

Set the low-pass filter’s cutoff frequency so that it’s lower than the power supply frequency.

Adding capacitors to signal lines

An effective way to address noise caused by superposed signal sources or high-frequency pulses is to insert a capacitor between the positive and negative input terminals. The capacitor will keep the noise out of the device's internal circuitry.

Use a capacitor whose rated voltage is greater than the voltage being input.

Since the filter is applied before channels are scanned, there are no limitations on the data refresh interval.

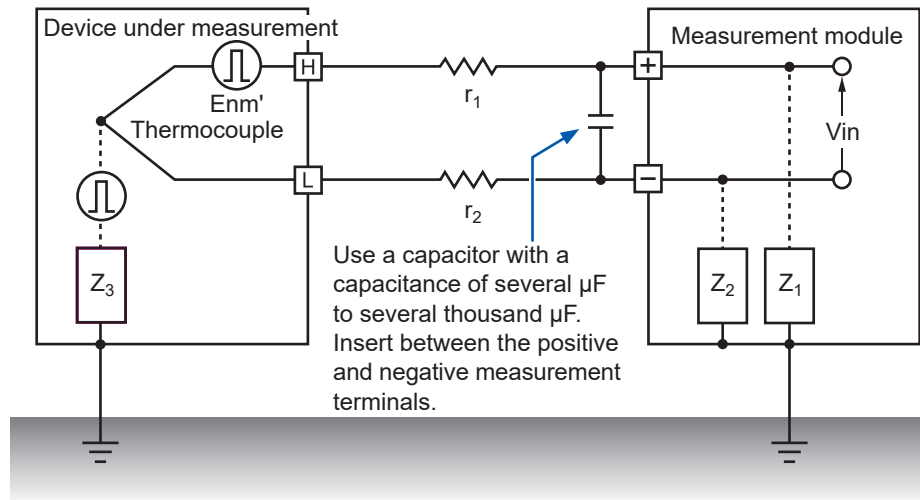

11.5 Scan Timing

The following modules acquire data by using relays to switch and scan input channels:

- U8550 Voltage/Temp Module
- U8551 Universal Module
- U8552 Voltage/Temp Module
- LR8530 Wireless Voltage/Temp Module
- LR8531 Wireless Universal Module
- LR8532 Wireless Voltage/Temp Module
- LR8533 Wireless High Speed Voltage Module

All input channels are scanned within the set data refresh interval.

Scanning starts with CH1 and then proceeds in order through all channels for which measurement is enabled (CH1 → CH2 → CH 3, etc.). Once the next data refresh interval has elapsed, sampling starts with CH1 again.

The scan duration per channel varies with the measurement module type, number of channels in use, data refresh interval, power supply frequency filter, and wire break detection setting.

U8550, U8551, LR8530, and LR8531

The following diagrams provide examples of typical scan timing for the U8550, U8551, LR8530, and LR8531.

Example: Data refresh interval of 10 ms, measurement on for all 15 channels, wire break detection off

Channels 1 to 15 are scanned with a duration of approximately 0.5 ms per channel. The scan starts again with CH1 after the data refresh interval of 10 ms has elapsed.

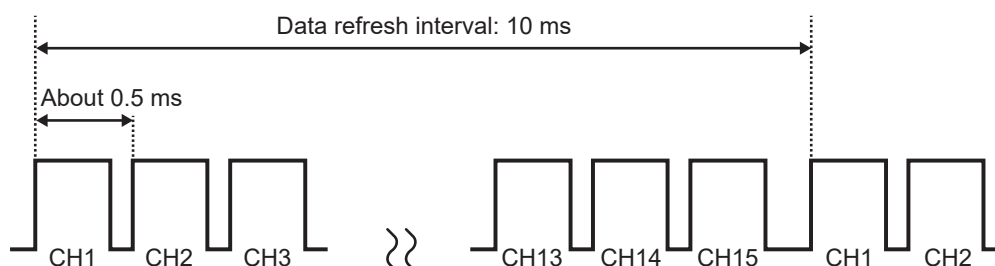

Example: Data refresh interval of 10 ms; measurement on for CH1, CH5, and CH15; wire break detection off

Only channels for which measurement is enabled are scanned; channels for which measurement is disabled are not scanned.

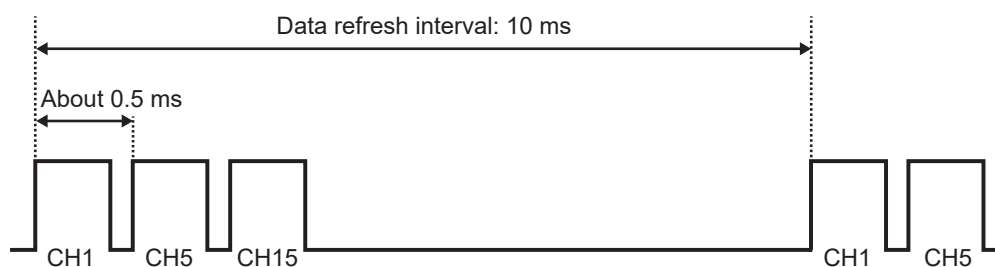

Example: Data refresh interval of 5 s, measurement on for all 15 channels, wire break detection off

Channels 1 to 15 are scanned with a duration of approximately 160 ms or 180 ms per channel, depending on the power supply frequency filter setting.

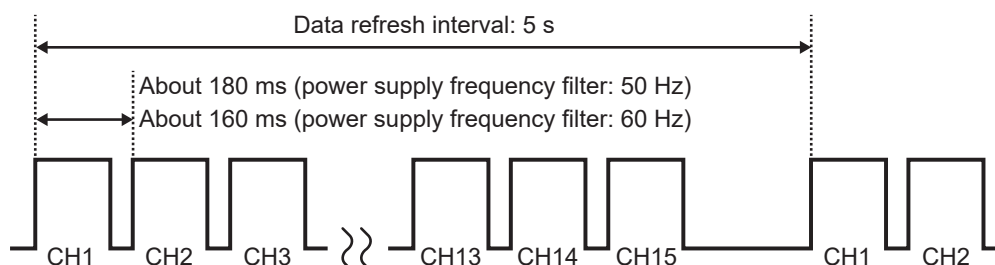

U8552 and LR8532

The following diagrams provide examples of typical scan timing for the U8552 and LR8532 when using from 16 to 30 channels. If the number of channels in use is 15 or less, the scan timing is the same as for the U8550, U8551, LR8530, and LR8531.

Example: Data refresh interval of 20 ms, measurement on for all 30 channels, wire break detection off

Channels 1 to 30 are scanned with a duration of approximately 0.5 ms per channel.

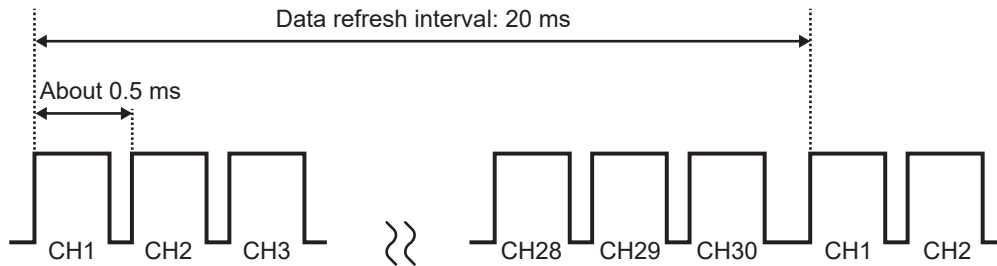

Example: Data refresh interval of 20 ms; measurement on for CH1 to CH10 and CH21 to CH30; wire break detection off

Only channels for which measurement is enabled are scanned; channels for which measurement is disabled are not scanned.

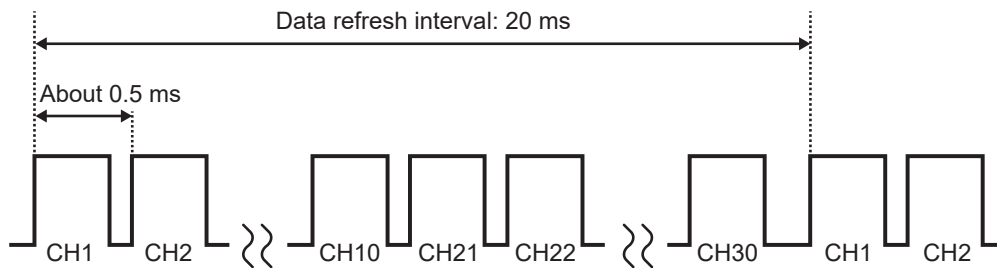

Example: Data refresh interval of 5 s, measurement on for all 30 channels, wire break detection off

Channels 1 to 30 are scanned with a duration of approximately 90 ms or 105 ms per channel, depending on the power supply frequency filter setting.

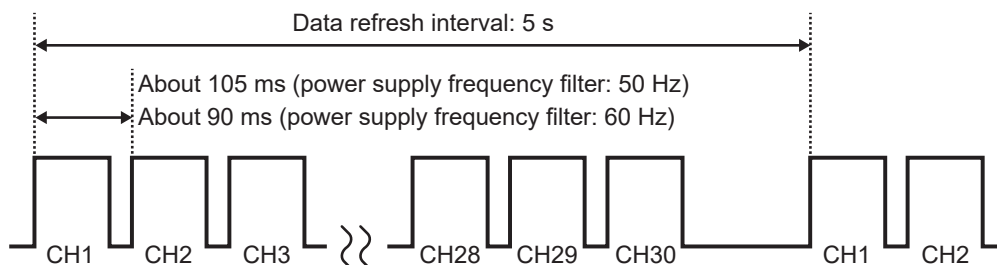

U8553 and LR8533

The following diagrams provide examples of typical scan timing for the U8553 and LR8533.

Example: Data refresh interval of 1 ms, measurement on for all 5 channels

Channels 1 to 5 are scanned with a duration of approximately 0.18 ms per channel.

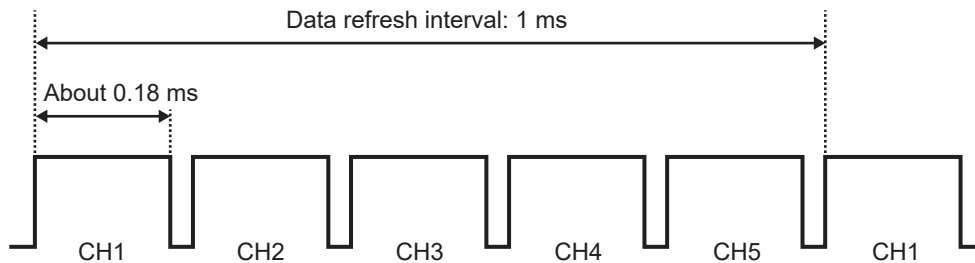

Example: Data refresh interval of 1 ms, measurement on for CH1 and CH5

Only channels for which measurement is enabled are scanned; channels for which measurement is disabled are not scanned.

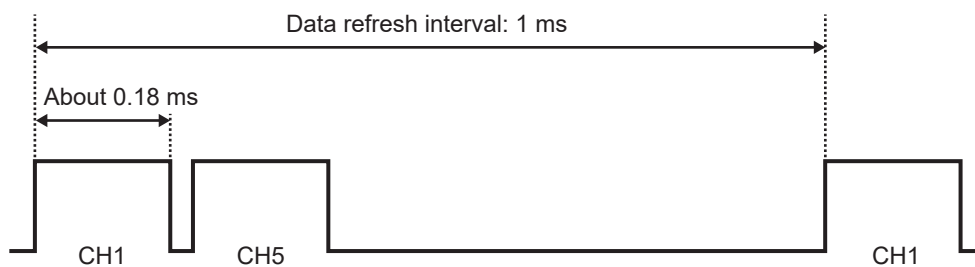

Example: Data refresh interval of 5 s, measurement on for all 5 channels

Channels 1 to 5 are scanned with a duration of approximately 900 ms per channel.

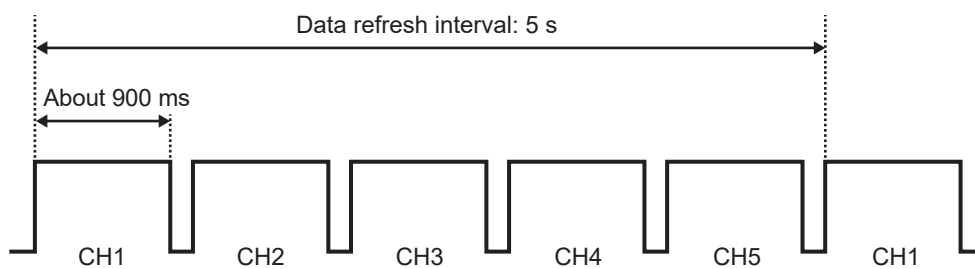

11.6 Filenames

Filenames consist of the following parts:

WAVE0001.MEM

1 2 3

No.	Item
1	File type
2	Automatic numbering
3	Extension

Data type	Folder	File type	Automatic numbering	Extension
Setting conditions	CONFIG	CONF	Starting at 0001	.SET
Waveform data	DATA *1	WAVE *2 AUTO *3	Starting at 0001	.MEM .CSV *4
Numerical calculation results: Without segmentation	MEASUREMENT /ALL	MEAS *2 AUTO *3	Starting at 0001*5	.CSV *4
Numerical calculation results: With segmentation	MEASUREMENT /PART	MEAS *2 AUTO *3	Starting at 0001*5	.CSV *4
Screen images	PICTURE	SCR	Starting at 00001	.PNG

- *1: Dated folders are created automatically. In delete-and-save operation, the oldest waveform files are deleted first.
Once all of the waveform files in the dated folder have been deleted, the folder will be automatically renamed.
Example: 19-12-26 (before update) → 19_12_26_191230_101113 (after update: date_date of update_time)
Hyphens ("-") are changed to underbars ("_"), and the date on which the folder was renamed is added to the end of the name.
(Updated at 10:11:13 am on December 30, 2019)
- *2: If saved manually.
- *3: If saved automatically. If a filename has been specified, that filename will be used.
- *4: If **[Delimiter]** is set to a setting other than **[Comma]**, the extension will be **[.TXT]**.
- *5: If **[File splitting]** under **[Numerical calculation results]** is set to **[Individual calc]**, the number (starting at 0001) will be followed by an underbar ("_") and the calculation number.

11.7 Text Format

Files saved in the text format consist of header and data sections.
The header includes the following information:

- (1) Filename and version number
- (2) Title comment
- (3) Trigger time
- (4) Channel number for each column*¹
- (5) Measurement*²
- (6) Range
- (7) Module identifier
- (8) Comments
- (9) Scaling setting
- (10) Scaling conversion ratio
- (11) Scaling offset
- (12) Channel number*¹ and module for each row
- (13) Data*³

```
"File name","AUTO0001.CSV","V 1.00" ..... (1)
"Title comment" ..... (2)
"Trigger Time","19-12-26 10:15:32" ..... (3)
"CH","U1-1","ALM1","ALM2"," ALM-SOURCE-1-A1"," ALM-SOURCE-2-A1","W1", ..... (4)
"Mode","Voltage","Alarm","Alarm","Alarm Source","Alarm Source","Calculation", ..... (5)
"Range","1V"," "," "," "," "," " ..... (6)
"UnitID"," "," "," "," "," "," " ..... (7)
"Comment"," "," "," "," "," " ..... (8)
"Scaling","OFF", ..... (9)
"Ratio","1.00000E+00", ..... (10)
"Offset","0.00000E+00", ..... (11)
"Time","U1-1[V]","ALM1","ALM2"," ALM-SOURCE-1-A1","ALM-SOURCE-2-A1","W1[V]","Event", ..... (12)
0.000000000E+00, -3.325000000E-02,0,0, "", "", -6.650000000E-02,0, ..... (13)
1.000000000E-01, 2.850000000E-02,1,0, "80000000H","", 5.700000000E-02,0,
2.000000000E-01, 9.600000000E-03,0,0, "", "", 1.920000000E-02,
3.000000000E-01, -2.560000000E-02,0,0, "", "", -5.120000000E-02,0,
4.000000000E-01, 4.560000000E-02,1,1, "80000000H","80000000H", 9.120000000E-02,0,
```

*1: Channel numbers are outputted on a data type by data type basis as follows:

Analog (Ux-xx), pulse (Py), logic (Ly), alarm (ALMy), alarm source (ALM-SOURCE y-z), and waveform calculation (Wxx).

(x: 1 to 11, xx: 1 to 30, y: 1 to 8, z: A1 to A11/P/L/W/OTHER)

*2: Outputted according to the measurement target as follows:

Voltage (Voltage), thermocouple (Tc), resistance temperature detector (Rtd), humidity (Humidity), resistance (Resistance), strain (Strain), count (Count), revolving speed (Revolve), logic (Logic), alarm (Alarm), alarm source (Alarm Source), and waveform calculation (Calculation).

*3: Outputted according to the measured data type as follows.

Data type	Output format
Analog	Exponential notation (six significant figures)
Pulse, waveform calculation	Exponential notation (10 significant figures)
Logic	0: Low, 1: High
Alarm	0: Not issued, 1: Issued
Alarm source	Hexadecimal notation (blank character when no alarm is issued)*4
Event mark	0: No mark assigned, 1 or greater: Marks assigned

*4: Varies depending on the data type

Data type	Description
Analog, pulse, waveform calculation	<p>Alarm onset statuses are outputted with channels assigned to each bit. (CH1 is assigned to the most significant bit [MSB].) An analog output and waveform calculation output are represented by eight characters (32 bits); pulse output and logic output are represented by two characters (8 bits). The letter H is added at the end.</p> <p>Example: When U1-1 issues an alarm, the alarm source output is represented by <i>0x80000000H</i>.</p>
Logic	<p>When a channel generates an alarm the output is represented by <i>1</i>; otherwise, represented by <i>0</i>. No letter is added at the end.</p> <p>Example: When a logic channel issues an alarm, the output is represented by <i>1</i>.</p>
Break in thermocouple, wireless communication error, low battery	<p>An alarm source output is represented by 12 characters (11 modules and a spare bit), in which a character (4 bits) is assigned to each module with an alarm status incorporated.</p> <p>A break in a thermocouple, wireless communication error, and low battery state are in order beginning from the MSB (for plug-in modules, broken thermocouple only). The letter <i>H</i> is added at the end.</p> <p>Example: When broken thermocouples are found in U2 and U4, the output is represented by <i>0x080800000000H</i>.</p>

11.8 File Size

This section describes how to calculate the size of binary format files.
Unit: bytes

File size

Header size + data size

Header size

Shared header size + text header size + binary header size

Shared header size

512

Text header size

$512 \times (10 + \text{number of measurement module channels} \times 5 + \text{number of pulse channels} \times 5 + \text{number of logic channels} \times 4 + \text{number of waveform calculation channels} \times 7 + \text{number of alarm headers}^{*1})$

*1: If alarms are enabled, 16; if not, 0.

Binary header size

$512 \times (1609 + \text{number of alarm headers}^{*2})$

*2: If alarms are enabled, 176; if not, 0.

Data size

$(\text{Number of measurement module channels} \times 2 + \text{number of pulse channels} \times 4 + \text{number of waveform calculation channels} \times 8 + \text{Logic data size}^{*3} + \text{alarm data size}^{*4}) \times \text{number of data points}$

*3: If any logic channel is enabled, 2; if not, 0.

*4: If alarms are enabled and alarm source data recording is enabled, 450;
if alarms are enabled but alarm source data recording is disabled, 2;
if alarms are off, 0.

11.9 Settings after Initialization (System Reset)

This section describes the settings (for the U8550) at the time of shipment from the factory and following initialization (system reset).

Screen		Setting		
Main	Sub	Setting	Default setting	
Measure	Record	Recording mode	Normal	
		Recording interval	10 ms	
		Repetitive recording	OFF	
		Recording time	Continuous	
		Alarm source	OFF	
	Auto save	File name		–
			Add trigger date/time	<input type="checkbox"/> (OFF)
		Media	SD card	
		Waveform data	Format	OFF
			Downsampling	OFF
			Deleting	OFF
			Folder splitting	Disable
		File splitting	File splitting	Disable
		Numerical calculation results	Format	OFF
			File splitting	Single file
		Text format	Decimal symbol*	Period
			Delimiter*	Comma
			Date format	yy-MM-dd hh:mm:ss.0
		Manual save	SAVE key settings	Select & Save
	File name			–
			Add trigger date/time	<input type="checkbox"/> (OFF)
	Media		SD card	
	Type		Waveform	
			Format	Binary
			Range	All
		Downsampling	OFF	
	Display	Horizontal axis	10 s	
		Display horizontal axis	Time	
		Number display format	Standard	

Screen		Setting			
Main	Sub	Setting	Default setting		
Channel	Individual	Input (for U8550)	Measurement	<input checked="" type="checkbox"/> (ON)	
			Input type	Voltage	
			Range	10 mV	
		Display	Position		
			Zoom	×1	
			Zero position	50%	
		Scaling	OFF		
		Comment	–		
		Numerical threshold	0		
Trigger	Common	Trigger	OFF		
		Timing	Start		
		Pre-trigger	Time	0 Days 00:00:00	
		Condition	Start	OR	
		External trigger	OFF		
		Interval trigger	OFF		
	Module n (n = 1, 2, . .)	Type	Start	OFF	
			Stop	OFF	
Alarm	Common	Alarm	OFF		
		Alarm hold	OFF		
		Alarm buzzer	OFF		
		Event mark	OFF		
	Alarm 1-8	ALM1 to ALM8	Filter	OFF	
			Comment	–	
Module	ALM	OFF			
Calculation	Numerical	Numerical calculation	OFF		
	Waveform	Waveform calculation	OFF		
System	Environment	Start backup	OFF		
		Backlight saver	OFF		
		Backlight brightness	3		
		Language*	English		
		Waveform background color	Dark		
		Beep sound	ON		
		Operation error prevention	ON		
		Power frequency filter	60 Hz		
	External	Voltage output1, 2	OFF		
		Alarm output1to 8	Low		
		External input1 to 3	OFF		
		External output	OFF		

*: Not restored by initialization. (Indicates the factory default setting here.)

11.10 Maximum Recording Times

The maximum amount of time during which data can be stored in the instrument’s internal buffer memory or on its storage media can be calculated as shown below.

If saving data in binary format, the maximum recording time can be calculated using the following formula:

$$\text{Maximum recording time} = \text{Recording capacity}^{*1} \times \text{recording interval (s)} / \text{data size}^{*2}$$

*1: For the instrument’s internal buffer memory (256 Mwords), $512 \times 1024 \times 1024$.

*2: Data size as described in “11.8 File Size” (p.289).

Maximum recording times (rough estimates)

Example: Measuring 30 analog channels with 2 modules (no alarm output, no waveform calculations)

Reduce the times shown in the following table by about 10% since they do not take into account the size of waveform file headers. The fewer channels are recorded, the greater the maximum recording time.

Recording interval	Internal buffer memory (512 MB)	Z4001 (2 GB)
100 ms	10 d 8 hr.	38 d 18 hr.
200 ms	20 d 17 hr.	77 d 12 hr.
500 ms	51 d 18 hr.	193 d 19 hr.
1 s	103 d 13 hr.	387 d 15 hr.
5 s	500 d	1162 d 21 hr.
10 s	500 d	3876 d 8 hr.

11.11 Application Measurement

Recording instrumentation signals (4-20 mA)

This section introduces a method for recording current output (4-20 mA) from instrumentation devices.

Average values for each minute can also be recorded using numerical calculations.

- Applicable modules: U8550, U8551, U8552, U8553, LR8530, LR8531, LR8532, LR8533
- You will need: An input cable and a 250 Ω shunt resistor

Instructions

- 1** Connect the input cable and the 250 Ω shunt resistor to the channel being measured.
Connect the shunt resistor between the positive and negative input terminals.
See “Connecting voltage cables and thermocouples” in the Quick Start Manual.
- 2** Connect the input cable to the instrumentation device’s current output (4-20 mA) terminal.
- 3** On the [Unit] screen, set the data refresh interval to [Auto].

SET > Measure > Record

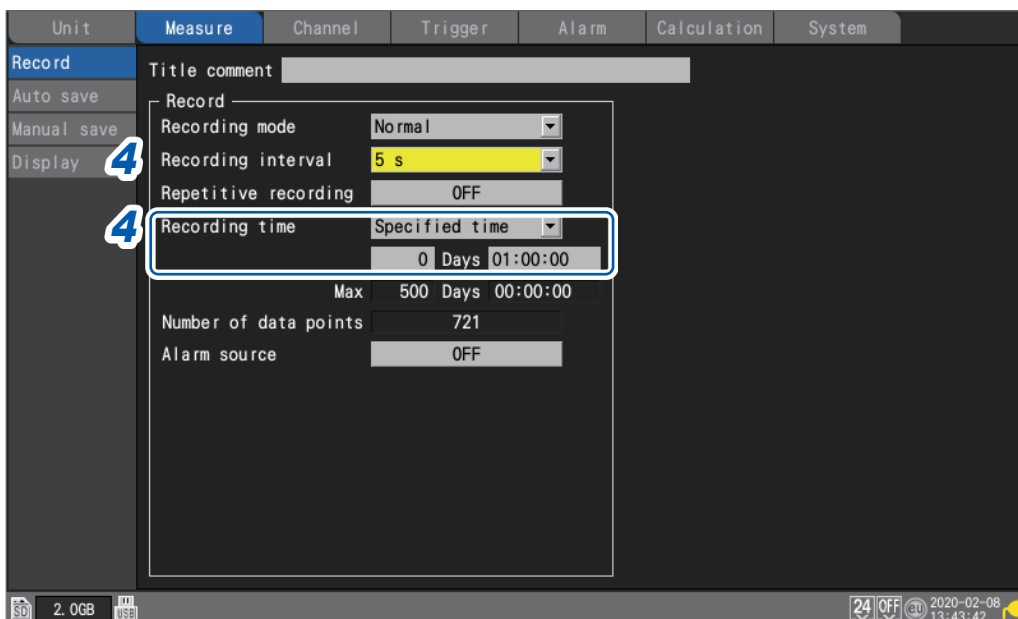

- 4** Configure the settings as follows:

Recording interval	5 s
Recording time	Specified time, 1 hour (0 Days 01:00:00)

SET > **Measure** > **Auto save**

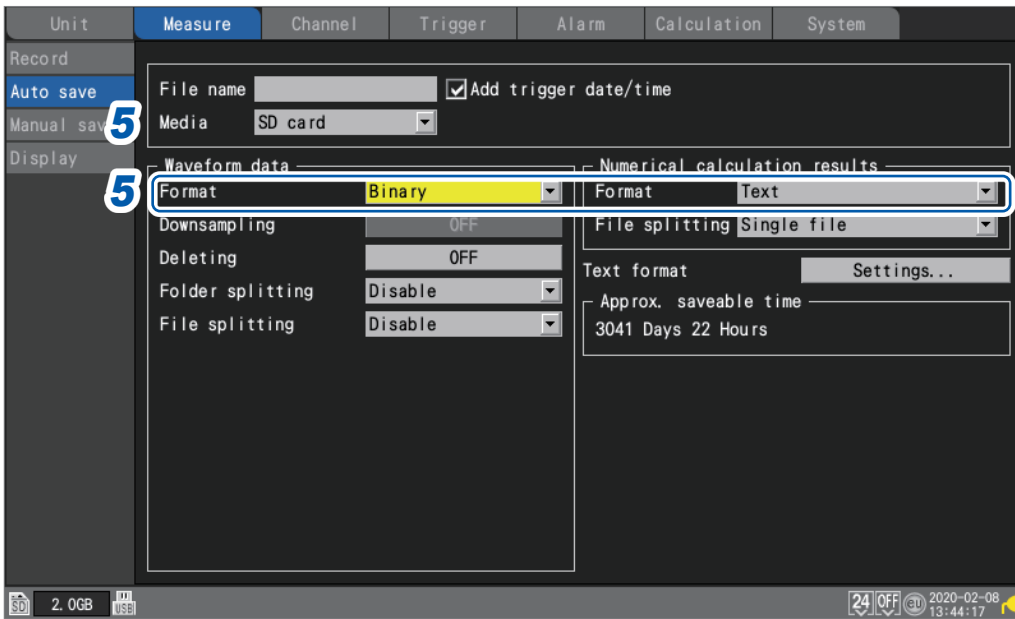

5 Configure the settings as follows:

Media	SD card
Format (Waveform data)	Binary
Format (Numerical calculation results)	Text

6 On the **[Calculation] > [Numerical]** screen, configure the settings as follows:

Numerical calculation	ON
Time split calculation	Enable
Split time	1 minute (0 Days 00:01)
Type	Average

SET > Channel > [Module n] (n = 1, 2, ...)

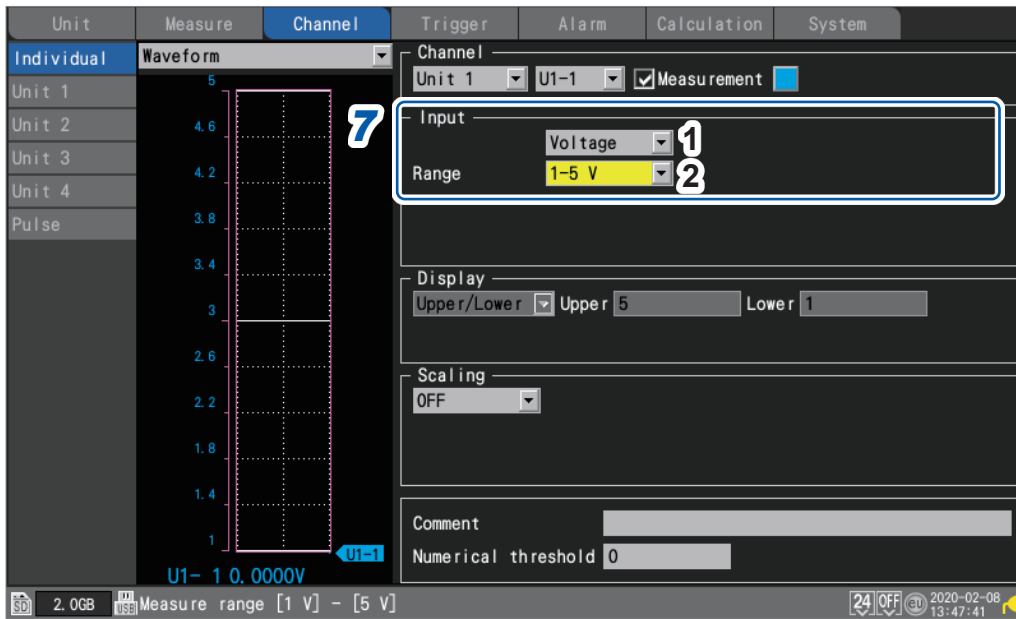

7 Configure the settings as follows in the [Input] area for the channel being measured:

1	Input type	Voltage
2	Range	1-5 V

Since a 250 Ω resistor has been connected to the input terminals, 4 mA will be recorded as 1 V, and 20 mA will be recorded as 5 V. The 1-5 V range is a range in which the 10 V range's display range lower and upper limits are set to 1 V and 5 V, respectively. If you wish to change the upper and lower limit values, use 10 V range.

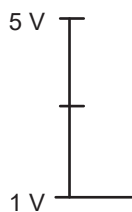

8 Press the **START** key to start measurement.

Data will be recorded at a 5 s interval for one hour. In addition, the average value numerical calculation will be performed every minute and the results saved to the SD Memory Card. Recording will stop 1 hr. after it starts. If you wish to end recording sooner, press the **STOP** key.

Measuring power consumption using pulse output from a watt-hour meter

This section introduces a method for measuring pulses from a watt-hour meter and converting them to power consumption.

The method involves measuring the pulse output from a watt-hour meter (50,000 pulses per kWh) and recording the power consumption every 30 min. and every month (30 days) on the SD Memory Card.

- You will need: An input cable

Instructions

- 1** Connect the pulse output from the watt-hour meter to the instrument's PULSE1 pulse input terminal.

SET > **Measure** > **Record**

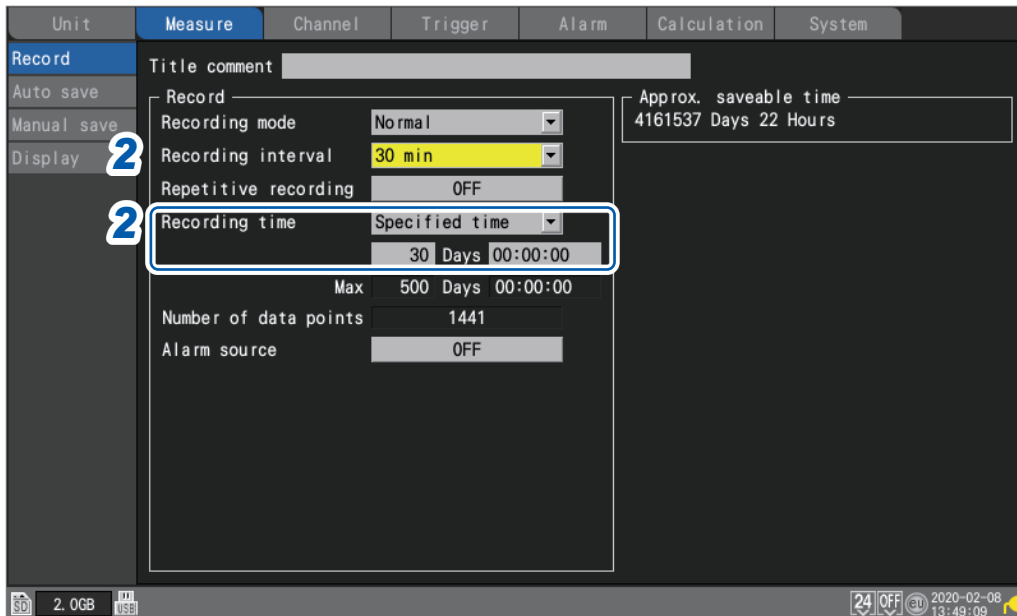

- 2** Configure the settings as follows:

Recording interval	30 min
Recording time	Specified time, 30 days (30 Days 00:00:00)

SET > Measure > Auto save

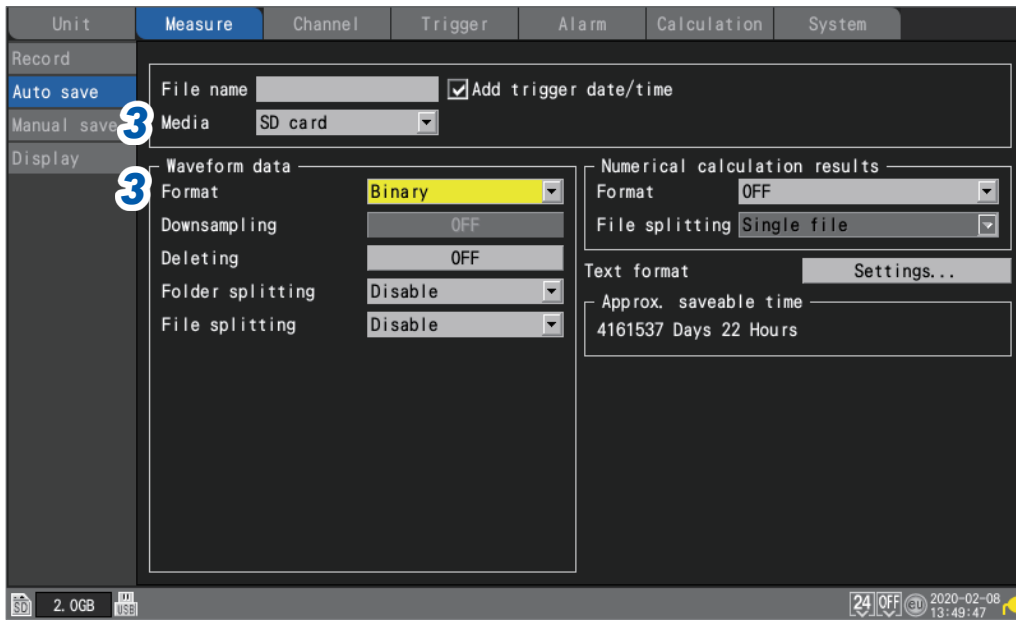

11

Knowledge and Information

3 Configure the settings as follows:

Media	SD card
Format	Binary

SET > Channel > Pulse

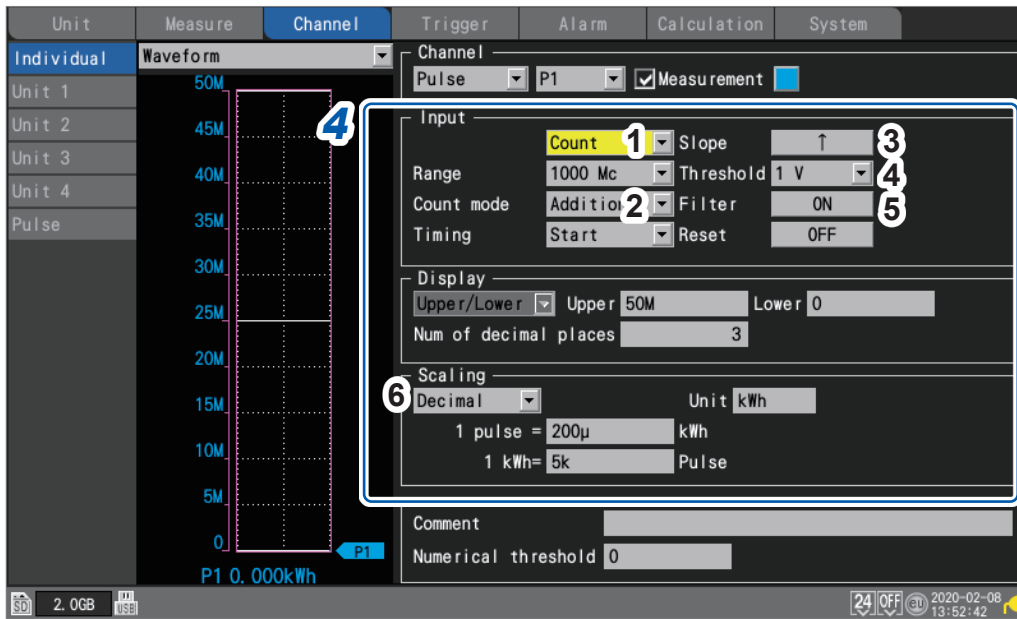

4 Under [P1] in [Pulse], configure the settings as follows:

1	Input type	Count
2	Count mode	Addition
3	Slope	↑ (depends on the specifications of watt-meter)
4	Threshold	1 V (depends on the specifications of watt-meter)
5	Filter	ON *
6	Scaling	Decimal, 1 kWh = 5000 (5 k), Unit: kWh

*To prevent false counting caused by chatter.

You can use the scaling function to convert the pulse count to energy (kWh).

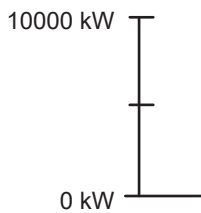

5 Press the **START** key to start measurement.

Data will be recorded at a 30 min. interval for 30 days, and waveform data will be saved on the SD Memory Card.

Recording will stop 30 days after it starts.

If you wish to end recording sooner, press the **STOP** key.

11.12 Input Circuit Schematics

This section provides input circuit schematics for the instrument.

Analog input circuit: U8550, U8551, U8552, LR8530, LR8531, LR8532

- Voltage (10 mV f.s. to 2 V f.s. ranges), thermocouple

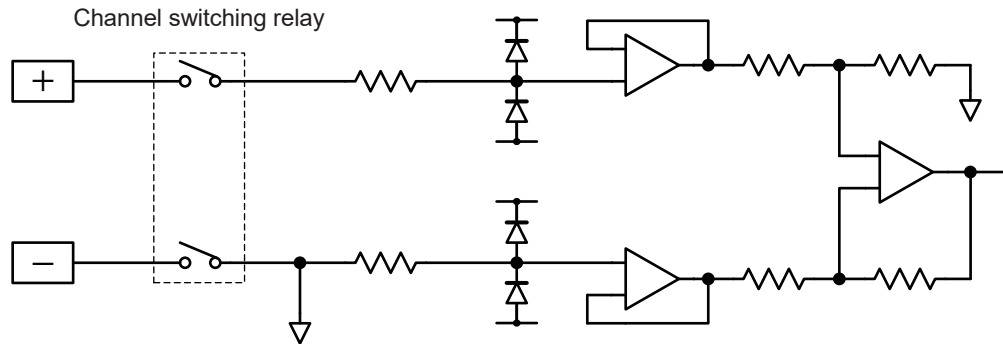

- Voltage (10 V f.s. to 100 V f.s. ranges, 1-5 V f.s. range), humidity

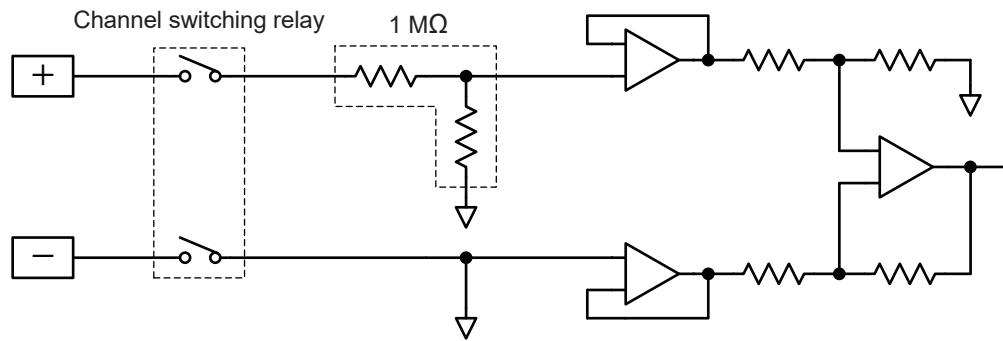

- Resistance temperature detector (4-wire), resistance

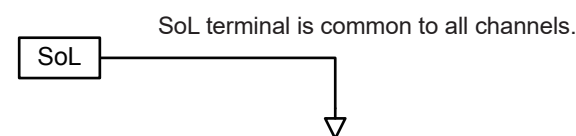
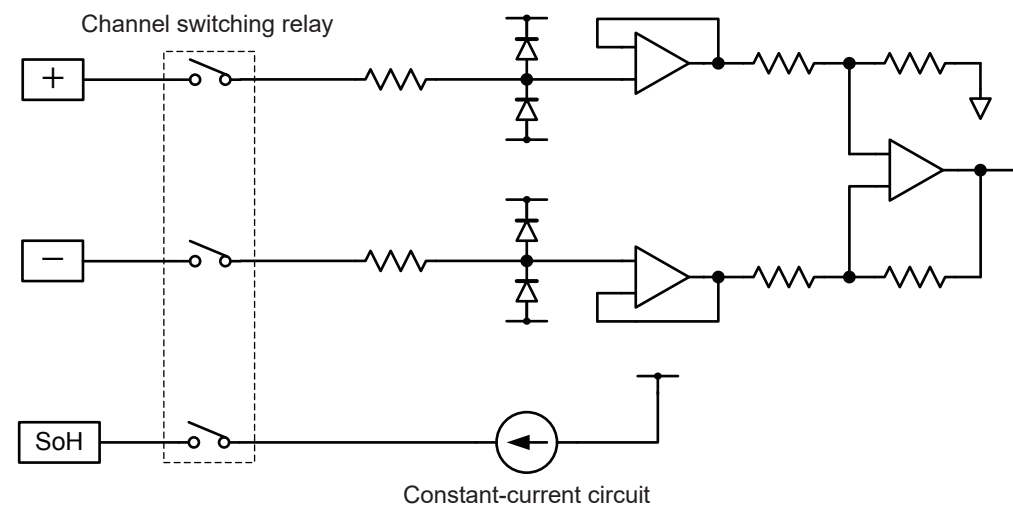

- Resistance temperature detector (3-wire)

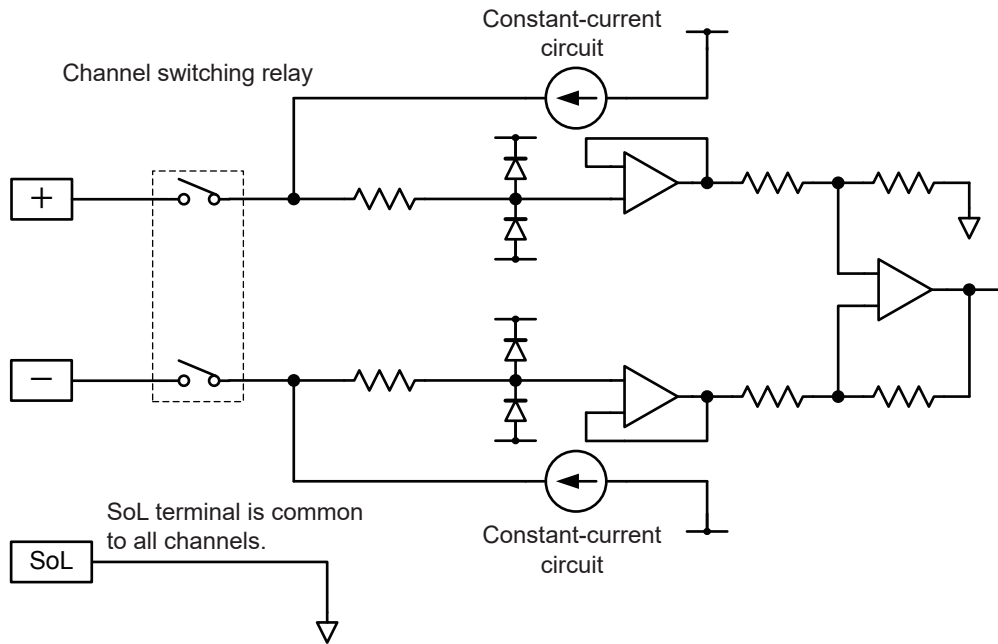

Analog input circuit: U8553, LR8533

- Voltage (100 mV f.s. to 2 V f.s. ranges)

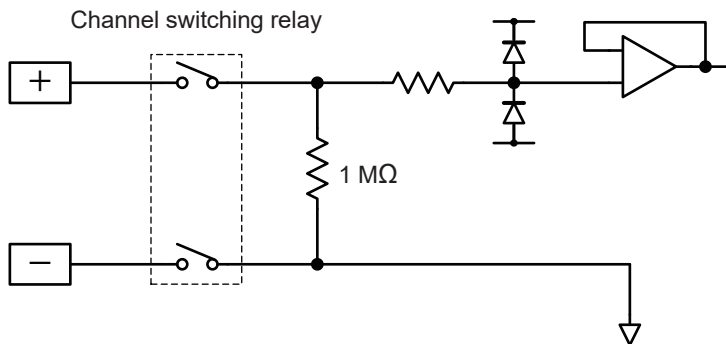

- Voltage (10 V f.s. to 100 V f.s. ranges)

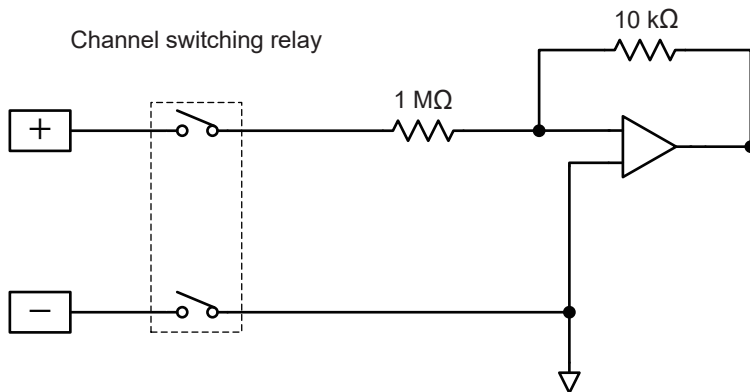

Analog input circuits: U8554, LR8534

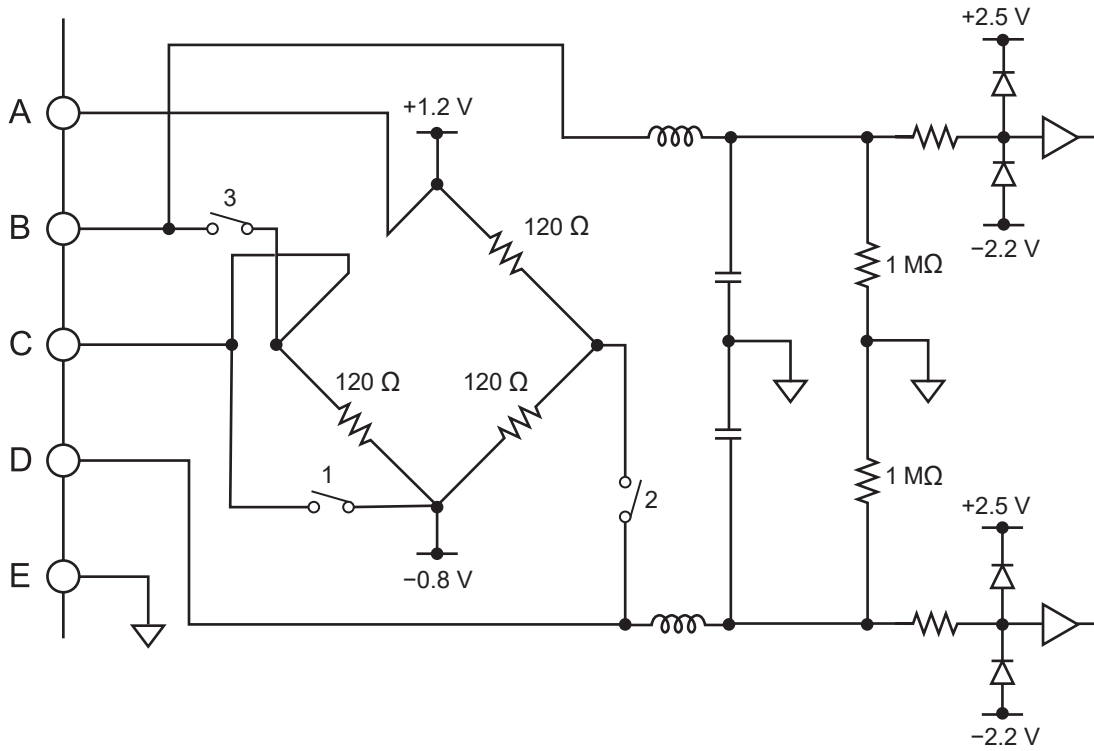

Pulse input circuit

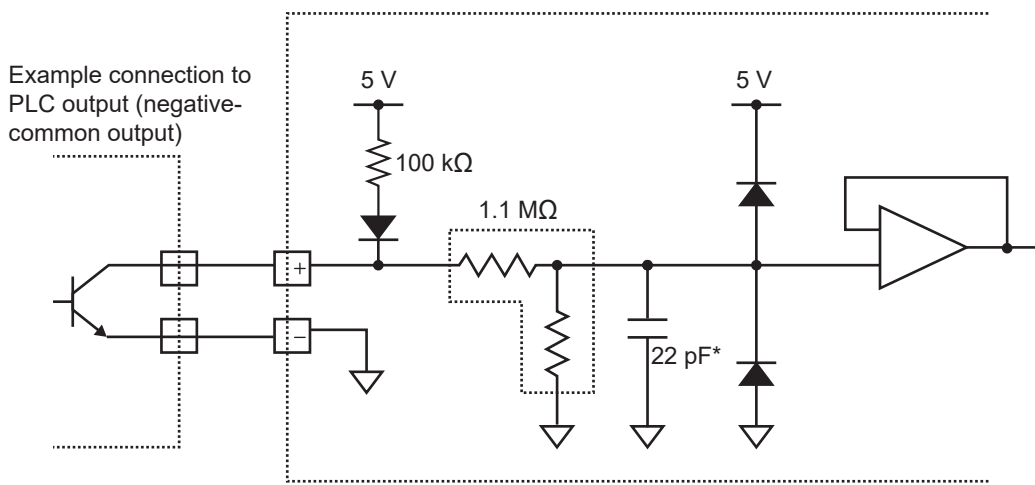

*If the chatter prevention filter is on, 0.047 μF.

11.13 Data Handling

In the following circumstances, calculated values and saved data are treated as shown in the table below:

- When the waveform significantly exceeds the range's measurable range (+OVER, -OVER)
- When communications are temporarily interrupted (NO DATA)
- When the instrument detects a thermocouple wire break during temperature measurement (wire break detection)

Input type	Input range	+OVER	-OVER	NO DATA	Wire break detection
Voltage	1 mV	0.00163835	- 0.0016384	0.00163825	-
	2 mV	0.0032767	- 0.0032768	0.0032765	-
	5 mV	0.00819175	- 0.008192	0.00819125	-
	10 mV	0.0163835	- 0.016384	0.0163825	-
	20 mV	0.032767	- 0.032768	0.032765	-
	50 mV	0.0819175	- 0.08192	0.0819125	-
	100 mV	0.163835	- 0.16384	0.163825	-
	200 mV	0.32767	- 0.32768	0.32765	-
	1 V	1.63835	- 1.6384	1.63825	-
	2 V	3.2767	- 3.2768	3.2765	-
	10 V	16.3835	- 16.384	16.3825	-
	20 V	32.767	- 32.768	32.765	-
	100 V	163.835	- 163.84	163.825	-
	1-5 V	16.3835	- 16.384	16.3825	-
Thermocouple	100°C	327.67	- 327.68	327.65	327.66
	500°C	1638.35	- 1638.4	1638.25	1638.3
	2000°C	3276.7	- 3276.8	3276.5	3276.6
Resistance temperature detector	100°C	327.67	- 327.68	327.65	-
	500°C	1638.35	- 1638.4	1638.25	-
	2000°C	3276.7	- 3276.8	3276.5	-
Humidity	100% RH	3276.7	- 3276.8	3276.5	-
Resistance	10 Ω	16.3835	- 16.384	16.3825	-
	20 Ω	32.767	- 32.768	32.765	-
	100 Ω	163.835	- 163.84	163.825	-
	200 Ω	327.67	- 327.68	327.65	-
Strain	1000 με	1638.35	- 1638.4	1638.25	-
	2000 με	3276.7	- 3276.8	3276.5	-
	5000 με	8191.75	- 8192	8191.25	-
	10000 με	16383.5	-16384	16382.5	-
	20000 με	32767	-32768	32765	-
	50000 με	81917.5	-81920	81912.5	-
	100000 με	163835	-163840	163825	-
	200000 με	327670	-327680	327650	-
Integration	1000 Mc	2147483647	-	-	-

Input type	Input range	+OVER	-OVER	NO DATA	Wire break detection
Rotational speed	5000 r/s	2147483647	–	–	–
	300000 r/min	2147483647	–	–	–

When performing calculations, the values in the table above are treated as follows:

✓: Included in calculation; –: Not included in calculation

Calculation type	+OVER	-OVER	NO DATA	Wire break detection
Numerical calculations	✓	✓	–	✓
Waveform calculations	✓	✓	✓	✓
Waveform screen (numerical value display)	✓*	✓*	–	–

*: Not included in average value calculations.

11.14 Displaying the Certification Number

This section describes how to display the certification number built into the instrument.

Instructions

- 1 Press and hold the QUICK SET key for at least 3 s and release.**
The certification number will be displayed.
The instrument cannot display the certification screen during measurement.
- 2 Press the ENTER key.**
The display will close.

Index

A

A/B cursors	75
Accessories	Quick
Aggregation (numerical calculation)	
ABS	153
Negative	153
Positive	153
Total	153
Alarm	129
Confirmation	137
Alarm output	175
Alarm source	12
Auto-balancing	28
Automatic calculations	150
Auto save	105, 106
Average	153

B

Backlight brightness	165
Backlight saver	164
Battery pack	102, Quick
Beep sound	165
Binary	106

C

Calculation formula	153
Channel comments	48
Channel list	50
Chatter prevention filter	30
Clock	167
Comments	47
Communication commands	229
Configuration navigator	78
Configuring settings	164
Connecting a LAN cable	196
Connecting a USB cable	125, 188
Contact correction	22
Continuous	12
Copy	55, 123, 161
Copying calculation formulas	161
Copying data	123
Copying settings	55
Cursor icon	61

D

Data protection	106
Data refresh interval	13
Date format	110
Decimal symbol	109
Delete	121
Deleting (delete and save)	108
Delimiter	109
Digital filter characteristics	275

Display colors	19, 21
Downsampling (thin and save)	108, 113, 115

E

Ejecting media	111
Event marks	140
Searching	143
External control	173
External control connections	79, Quick
External trigger input	179
External triggers	94
EXT. I/O	173

F

FILE key	103, 117, 119
File mode	118
Filenames	286
File size	289
File splitting	109, 113, 116
Filters	20
Folder splitting	108
Formatting media	103
FTP client	210
FTP server	206

G

Gage (scale)	65
--------------------	----

H

Horizontal axis cursors	75
Horizontal axis display	40
HTTP server	201
Humidity	25

I

Immediate save	105, 112
Individual settings screen	17
Individual settings window	18, 133
Initialization	169, 290
Input channels	16
Input circuits	299
Input/output terminals	177
Integrating pulses	29
Integration	
ABS	154
Negative	154
Positive	154
Total	154
Interval triggers	95

J

Jump 74

K

Key lock 6, Quick

L

Language 165
 LAN settings
 Computer 189
 LR8450 (-10) 192
 Level triggers 83, 89
 Loading data 99, 117
 Logger Utility 185
 Logic signals 34
 Logic triggers 92

M

Manual calculations 151
 Manual save 112
 Marking 139
 Maximum 153
 Measuring strain 27
 Measuring voltage 19
 Media (priority save destination) 107, 112
 Minimum 153
 Monitor 58
 MONITOR key 58
 Moving between folders 120
 Moving waveforms 69

N

Network settings 191
 Noise countermeasures 276
 NTP client function 168
 Numerical calculation equations 153
 Numerical calculations 146
 Numerical value display 66
 Numerical value display format 41

O

Observing waveforms 60
 Operation 6
 Operation error prevention 165
 Options Quick

P

Partial numerical calculations 152

Part names and functions, screens Quick
 Pattern triggers 83, 92
 Plug-in modules 243, Quick
 Position 36
 Power frequency filter 166
 P-P (peak-to-peak value) 153
 Prefix 7
 Pre-trigger 84
 Pulses 29

Q

QUICK SET 78

R

Ranges 19
 Range specification 77
 Real-time numerical calculations 150
 Real-time save 106
 Recording interval 11, 14
 Recording mode 11
 Recording time 12
 Reference junction compensation (RJC) 22
 Refresh interval 13
 Remote operation 203
 Rename 122
 Repetitive recording 11
 Replacing media (ejecting media) 111
 Resetting the system 169
 Resistance 26
 Resistance temperature detector (RTD) 24
 Rotational speed 31

S

Save 99
 Auto save 105, 106
 Immediate save 105, 112
 Selective save 105, 114
 Saving data 105
 Scale 65
 Scaling 42
 Scanning 282
 Scroll bar 71
 SCROLL/CURSOR key 69
 Scroll icon 61
 Scrolling 69
 Search 72
 Searching waveforms 72
 Selective save 105, 114
 SELECT key 70, 121
 Self-check 171
 Serial No. 170, Quick
 Setting measurement conditions 10
 Settings at once 56, 162
 Settings list screen 18, 133

Setting the time.....	167
Simultaneously starting measurement	182
SI prefixes.....	7
Smoothing	32
Sorting files.....	124
Specifications	231
Plug-in modules	243
Specified time	12
Start.....	59
Start back up	164
Start backup (start state retention)	164
Stop	59
Strain	270
Strain gage connections	78, Quick
Switching media	119
Synchronizing the time	168
System.....	163
System configuration.....	170
System reset (initializing the system).....	169, 290

T

Temperature measurement	269
Temperature (resistance temperature detector)	24
Temperature (thermocouple)	21
Text.....	106, 287
Text entry.....	8
Thermocouple connections	Quick
Thermocouple (Tc).....	21
Time split calculation	147
Time values	
Time to max	153
Time to min	153
Time zone.....	167
Timing (Trigger timing).....	84
Title comments	47
Trigger function.....	81
Trigger output	180
Trigger output timing.....	181
Trigger points.....	81

U

Unit identifiers.....	49
Upper and lower limits	39
USB drive mode	126
USB driver	186
USB settings.....	186

V

Value entry.....	7
Vertical axis cursors.....	75
Vertical axis display	36
Voltage cable connections.....	Quick
Voltage output.....	174
Voltage output connections	Quick

W

Waveform background color.....	165
Waveform calculations	155
Waveform display	36, 62
Waveform display colors	19, 21
Waveform screen	60
WAVE key.....	60
Window triggers.....	83, 91
Wire break detection (Burn out).....	22
Wireless LAN.....	199
Wiring method	24

Z

Zero adjustment.....	57
Zero position.....	37
Zoom	36