

LR8450

LR8450-01

HIOKI

Quick Start Manual

MEMORY HILOGGER



**Test Equipment
Depot**
1-800-517-8431

99 Washington Street
Melrose, MA 02176
Phone 781-665-1400
Toll Free 1-800-517-8431

▶ Visit us at www.TestEquipmentDepot.com

! Be sure to read this manual before using the instrument.

▶ p.6

✓ When using the instrument for the first time

Introduction to Convenient Functionality	▶ p.14
Part Names and Functions; Screens	▶ p.23
Making Connections (Preparing for Measurement)	▶ p.37
Settings and Operation	▶ p.69

📖 Troubleshooting

Maintenance and Service	▶ p.79
Error messages	▶ p.83
FAQ	▶ p.91

Contents

Introduction.....	1
About the Notations Used in This Manual.....	2
Checking Package Contents.....	4
Options (sold separately)	5
Safety	6
Operating Precautions	8
How to Use This Manual	13
Introduction to Convenient Functionality	14

1 Overview 21

1.1 Instrument Overview and Features.....	21
1.2 Part Names and Functions; Screens.....	23
LR8450/LR8450-01 Memory HiLogger	23
Plug-in modules	29
Wireless modules	30
1.3 Options.....	32
Plug-in modules	32
Wireless modules	32
Other options.....	33
1.4 Measurement Process.....	35

2 Making Connections (Preparing for Measurement) 37

2.1 Connecting Plug-in Modules.....	38
2.2 Installing a Battery Pack.....	40
2.3 Connecting the AC Adapter.....	45
2.4 Connecting the Cables	47
Pre-use inspection	47
Connecting voltage cables and thermocouples	50
Connecting resistance bulbs	52
Connecting the Humidity Sensor	53
Connecting a resistor	55
Connecting a strain gage or strain gage-type converter.....	56
Connecting pulse input.....	59
Connecting alarm output.....	60
Connecting voltage output.....	61
Connecting external control signals	63
2.5 Turning the Instrument On and Off	64
2.6 SD Memory Card and USB Drive	65
Inserting and removing SD Memory Cards	67
Inserting and removing USB Drives	68

3 Settings and Operation 69

3.1 Configuration Process	70
3.2 Basic Operation	71
Switching among the main tabs.....	71
Switching among the sub tabs.....	71
Changing and accepting settings.....	72
Starting and stopping measurement	73
Saving data	73
Resetting the system (initialization).....	74
Key lock (disabling keys).....	74

4 Specifications 75

4.1 Memory HiLogger Basic Specifications.....	75
4.2 Plug-in Module Specifications	76
U8550 Voltage/Temp Unit.....	76
U8551 Universal Unit.....	76
U8552 Voltage/Temp Unit.....	77
U8553 High Speed Voltage Unit.....	77
U8554 Strain Unit	78

5 Maintenance and Service 79

5.1 Repairs, Inspections, and Cleaning.....	79
5.2 Troubleshooting	81
Before sending the instrument to be repaired	81
Error messages	83
5.3 Disposing of the Instrument.....	90
5.4 FAQ (Frequently Asked Questions)	91
5.5 Open-source software	93

Index 95

Warranty

Introduction

Thank you for choosing the Hioki LR8450/LR8450-01 Memory HiLogger. To ensure your ability to get the most out of this instrument over the long term, please read this manual carefully and keep it available for future reference.

The LR8450-01 Memory HiLogger adds wireless LAN functionality to the LR8450. Hioki plans to launch wireless modules and a Wireless LAN Adapter in the near future.

This instrument comes with the following documentation. Please refer to these resources as necessary in light of your specific application. Please review the separate “Operating Precautions” before using the instrument.

Model	Manual contents	Printed edition	CD edition
Operating Precautions	Information to ensure safe use of the instrument	✓	–
Precautions Concerning Use of Equipment That Emits Radio Waves (LR8450-01 only)	Precautions relating to use of equipment that emits radio waves, countries in which the instrument has been certified, etc.	✓	–
Quick Start Manual (this manual)	Basic connection and operating instructions for the instrument	✓	✓
Instruction Manual	Detailed information about the instrument and specifications	–	✓
Logger Utility* ¹ User Manual	Information about how to install and use the computer application	–	✓
Communications Commands* ² User Manual	Explanation of communications commands for controlling the instrument	–	✓

*1: For information about how to install and use the Logger Utility computer application, see “Logger Utility User Manual” on the included CD (application disc).

*2: The instrument can be controlled by a LAN- or USB-connected computer. For more information about the communications commands used to control the instrument, see “Communications Commands User Manual” on the included CD (application disc).

Intended audience

This manual has been written for use by individuals who use the product or provide information about how to use the product.

In explaining how to use the product, it assumes electrical knowledge (equivalent of the knowledge possessed by a graduate of an electrical program at a technical high school).

Trademarks

- Microsoft, Windows, Excel, Internet Explorer, and Visual Basic are the registered trademarks or trademarks of Microsoft Corporation in the U.S., Japan, and other countries.
- SD, SDHC Logos are trademarks of SD-3C LLC.
- Wi-Fi® is a registered trademark of the Wi-Fi Alliance®.
- Other products and company names are trade names, registered trademarks or trademarks of their respective owners.







Screen font

- The typefaces included herein are solely developed by DynaComware Taiwan Inc.







About the Notations Used in This Manual

Safety notations



This manual classifies seriousness of risks and hazard levels as described below.

 DANGER	Indicates an imminently hazardous situation that, if not avoided, will result in death of or serious injury to the operator.
 WARNING	Indicates a potentially hazardous situation that, if not avoided, could result in death of or serious injury to the operator.
 CAUTION	Indicates a potentially hazardous situation that, if not avoided, could result in minor or moderate injury to the operator.
NOTICE	Indicates the possibility of equipment damage.
IMPORTANT	Indicates information or content that is particularly important from the standpoint of operating or maintaining the instrument.
	Indicates a high-voltage hazard. Failure to verify safety or improper handling of the instrument could lead to electric shock, burns, or death.
	Indicates an action that must not be performed.
	Indicates action that must be performed.

Symbols on equipment

	Indicates the need for caution or the presence of a hazard. For more information about locations where this symbol appears on instrument components, see “Operating Precautions” (p.8), warning messages listed at the beginning of operating instructions, and the document entitled “Operating Precautions” that comes with the instrument.
	Indicates an instrument that has been protected throughout.
	Indicates whether the power is on or off.
	Indicates the ground terminal.
	Indicates direct current (DC).
	Indicates alternating current (AC).

Notations related to standards compliance

	Indicates compliance with the Waste Electrical and Electronic Equipment (WEEE) Directive in EU member nations.
 Li-ion	Indicates that the instrument is targeted for recycling under the Act on the Promotion of Effective Utilization of Resources.
	Indicates that the instrument complies with standards imposed by EU directives.

Other notations

	Indicates useful advice concerning instrument performance and operation.
*	Instructs the reader to see below for additional information.
<input checked="" type="checkbox"/>	Indicates the default setting. When initialized, the instrument will revert to this value.
(p.)	Indicates the page number to reference.
Bold	The names of control keys are printed in bold.
[]	The names of user interface elements on the screen are enclosed in brackets ([]).
Windows	Unless otherwise noted, the term “Windows” is used generically to refer to Windows 7, Windows 8, and Windows 10.
S/s	For this instrument, the number of times the analog input signal is digitized is indicated in samples per second (S/s). Example: 20 Ms/s (20 megasamples per second) signifies 20×10^6 samples per second.

Accuracy

Hioki defines tolerances for measured values in terms of f.s. (full scale), as indicated below.

f.s.	Maximum display value, scale magnitude Indicates the maximum display value or scale magnitude. Generally speaking, the f.s. figure indicates the range in current use. Example: f.s. for the 1 V range = 1 V
------	---

Checking Package Contents

When you receive the instrument, inspect it to ensure that no damage occurred during shipment. Pay particular attention to included accessories, panel keys and switches, and terminals. If you find any damage or discover that the instrument does not perform as indicated in its specifications, please contact your authorized Hioki distributor or reseller.

Check to ensure proper package contents.

The instrument

- LR8450/LR8450-01 Memory HiLogger

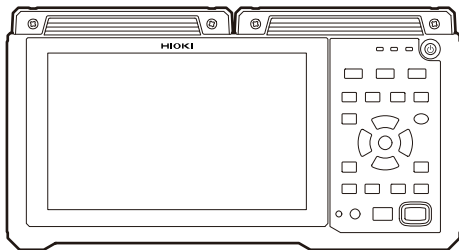

Accessories

- Z1014 AC Adapter (with power cord)
See "2.3 Connecting the AC Adapter" (p. 45).
- Operating Precautions (0990A903)
- Precautions Concerning Use of Equipment That Emits Radio Waves (0990A962)
(LR8450-01 only)
- Quick Start Manual (this manual)
- LOGGER Application Disc (CD)*
 - Quick Start Manual
 - Instruction Manual
 - Logger Utility
 - Logger Utility Instruction Manual
 - Communications Commands Instruction Manual
- USB cable
See "3.6 Acquiring Data with a Computer (PC)" in the Instruction Manual.

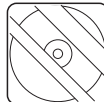
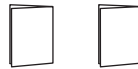
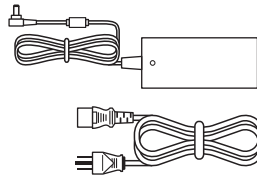

*: The most recent version is available for download from Hioki's website.

Options (sold separately)

The options listed below are available for the instrument. To order an option, please contact your authorized Hioki distributor or reseller. Options are subject to change. Check Hioki's website for the latest information.

U8550 Voltage/Temp Unit
U8551 Universal Unit
U8552 Voltage/Temp Unit
U8553 High Speed Voltage Unit
U8554 Strain Unit
LR8530 Wireless Voltage/Temp Unit (available soon)
LR8531 Wireless Universal Unit (available soon)
LR8532 Wireless Voltage/Temp Unit (available soon)
LR8533 Wireless High Speed Voltage Unit (available soon)
LR8534 Wireless Strain Unit (available soon)
Z1014 AC Adapter (accessory)
Z1007 Battery Pack
Z5040 Fixed Stand
C1012 Carrying Case
Z4001 SD Memory Card (2 GB)
Z4003 SD Memory Card (8 GB)
Z4006 USB Drive (16 GB)
9642 LAN Cable

Safety

The instrument and modules designed for use with the instrument have been designed in accordance with the IEC 61010 safety standard, and their safety has been verified by means of testing prior to shipment. However, failure to follow the information in this manual could render safety-related functionality provided by the instrument ineffective.

Please review the safety information below before using the instrument.

DANGER



- **Read this manual carefully and ensure you understand its contents before using the instrument.**

Improper use of the instrument could result in serious bodily injury or damage to the instrument.

WARNING



- **If using an electrical measuring instrument for the first time, seek instruction from an individual with electrical measurement experience first.**

Failure to do so may lead to electric shock, overheating, fire, arcing due to a short-circuit, or other hazards.

Measurement categories

IEC 61010 defines measurement categories to facilitate safe use of measuring instruments. Test and measurement circuits designed to be connected to a main power supply circuit are classified into three categories depending on the type of main power supply circuit.

DANGER

- Do not use an instrument to measure a main power supply circuit whose category exceeds the instrument's rated measurement category.



- Do not use an instrument that does not have a rated measurement category to measure a main power supply circuit.

Doing so may result in serious bodily injury or damage to the instrument or other equipment.

CAT II Applicable to test and measuring circuits connected directly to utilization points (socket outlets and similar points) of the low-voltage mains installation.
Examples: Measurements on household appliances, portable tools, and similar equipment, and on the consumer side only of socket-outlets in the fixed installation.

CAT III Applicable to test and measuring circuits connected to the distribution part of the building's low-voltage mains installation.
Examples: Measurements on distribution boards (including secondary meters), photovoltaic panels, circuit breakers, wiring, including cables, bus-bars, junction boxes, switches, socket-outlets in the fixed installation, and equipment for industrial use and some other equipment such as stationary motors with permanent connection to the fixed installation.

CAT IV Applicable to test and measuring circuits connected at the source of the building's low-voltage mains installation.
Examples: Measurements on devices installed before the main fuse or circuit breaker in the building installation.

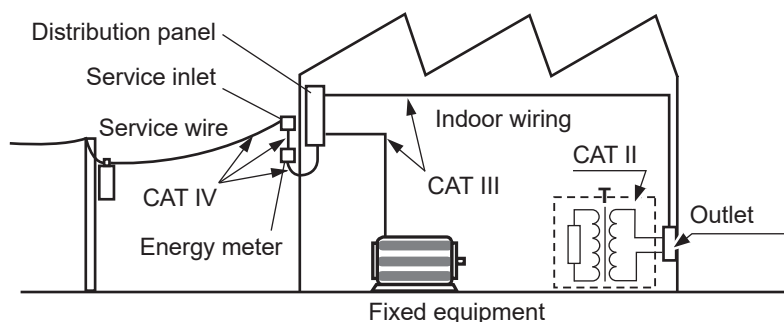

Operating Precautions

Be sure to follow the precautions listed below in order to use the instrument safely and in a manner that allows it to function effectively.

Use of the instrument should conform not only to its specifications, but also to the specifications of all accessories, options, and other equipment in use.

Checking safety prior to use

DANGER

■ **Inspect the instrument and verify proper operation before use.**



Use of the instrument while malfunctioning could result in serious bodily injury. If you find any damage, contact your authorized Hioki distributor or reseller. For more information about inspections, see “Inspection of the instrument” (p.47).

Installing the instrument

For more information about the instrument’s operating temperature and humidity range and its storage temperature and humidity range, see “4 Specifications” (p.75).

WARNING

■ **Do not install the instrument in locations such as the following:**



- In locations where it would be subject to direct sunlight or high temperatures
- In locations where it would be exposed to corrosive or explosive gases
- In locations where it would be exposed to powerful electromagnetic radiation or close to objects carrying an electric charge
- Close to inductive heating devices (high-frequency inductive heating devices, IH cooktops, etc.)
- In locations characterized by a large amount of mechanical vibration
- In locations where it would be exposed to water, oil, chemicals, or solvents
- In locations where it would be exposed to high humidity or condensation
- In locations with an excessive amount of dust

Doing so could damage the instrument or cause it to malfunction, resulting in bodily injury.

CAUTION

■ **Do not place the instrument on an unstable stand or angled surface.**

Doing so could cause the instrument to fall or overturn, resulting in bodily injury or damage to the instrument.



■ **Do not bend or pull on cables at temperatures of 0°C or lower.**

Since cables become rigid, doing so could damage the insulation or cause a wire break, resulting in electric shock.

Installing the instrument (continued)

NOTICE

- **Do not unplug data cables while the instrument is sending or receiving data.**

Doing so could damage the instrument.



- **Turn off the instrument and computer before connecting or disconnecting data cables.**

Failure to do so could cause the instrument to malfunction or damage it.

- **Use the same ground for the instrument and computer.**

Connecting data cables while there is a potential difference between the instrument and computer's ground levels could cause the instrument to malfunction or damage it.

IMPORTANT

- Ensure that the ambient temperature near the terminal blocks does not change. In particular, ensure that air from a ventilation fan, air conditioner, or similar device does not flow directly onto the instrument. When using thermocouple input, the resulting change in ambient temperature could introduce measurement error.
- When moving the instrument to a location with a significantly different temperature, allow the instrument to sit for at least 60 minutes before starting measurement.

Do not block vent openings. (Leave at least 5 cm of space on the left and right sides of the instrument in order to keep its temperature from rising.)

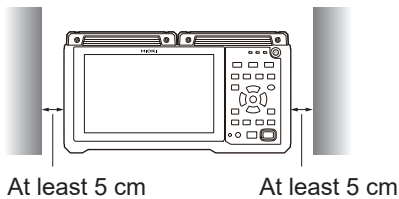

The instrument is classified as a Class A device under the EN 61326 standard. Use of the instrument in a residential setting such as a neighborhood could interfere with reception of radio and television broadcasts. If you encounter this issue, take steps as appropriate to address it.

Measurement precautions

DANGER

- **Do not input a voltage that exceeds the measurement module's maximum input voltage, maximum rated terminal-to-ground voltage, or maximum rated channel-to-channel voltage to any channel.**

- **Do not input a voltage to a resistance measurement terminal.**

Measurement modules have different maximum input voltages, maximum rated terminal-to-ground voltages, and maximum rated channel-to-channel voltages. For more information about maximum input voltages, maximum rated terminal-to-ground voltages, and maximum rated channel-to-channel voltages, see "Specifications" (p. 75).



Doing so could cause electric shock or damage the instrument.

- **Do not use the instrument or measurement modules to measure a main power supply circuit.**

The U8550, U8551, U8552, U8553, LR8530, LR8531, LR8532, and LR8533 measurement modules have terminal-to-ground voltages that qualify as CAT II, but they cannot be used to perform CAT II, CAT III, or CAT IV measurement. Never input a CAT II, CAT III, or CAT IV voltage across measurement terminals. Doing so could cause electric shock or damage the instrument.



- **Turn off power to the circuit under measurement before performing measurement.**

Failure to do so could cause electric shock or damage the instrument.

WARNING

- **Do not allow the instrument to get wet.**



- **Do not operate the instrument with wet hands.**

Doing so could cause electric shock.



Displayed values can frequently fluctuate due to induction potential even when no voltage is applied. This, however, is not a malfunction.

Shipping precautions

Store packaging materials for future use. You will need the packaging materials when shipping the instrument.

NOTICE



- **Do not subject the instrument to vibration or mechanical shock while transporting or handling it.**
- **Do not drop the instrument.**
Doing so could damage the instrument.

When transporting the Z1007 Battery Pack on an aircraft

- The Z1007 Battery Pack uses rechargeable lithium-ion batteries.
- The transport of lithium-ion batteries by air is subject to regulations in accordance with United Nations recommendations.
- If you need to repair or calibrate any device that uses the Z1007 Battery Pack or to transport such devices by air, contact your authorized Hioki distributor or reseller.

Precautions related to disc usage

- Exercise care to keep the recording surface of the disc free of dirt and damage. If you need to label the disc, for example with text, use a marker with a soft tip.
- Store discs in protective cases. Avoid exposing discs to direct sunlight, high temperatures, or high humidity.
- Hioki is not liable for any computer system issues that arise in connection with the use of this disc.

Wireless LAN

The LR8450-01 Memory HiLogger and Z3230 Wireless LAN Adapter use radio communications in the 2.4 GHz band. No regulatory permit is necessary to use the product, but caution should be exercised with regard to the following:

DANGER



- **Do not use the instrument in proximity to medical devices such as pacemakers.**

Radio waves from the instrument may affect operation of the pacemaker or other medical device, causing it to malfunction or damaging it.

WARNING



- **Do not use the instrument with medical equipment, nuclear power equipment or devices, aerospace equipment, transport equipment or devices, or other equipment or devices being used in applications that affect human life, or with equipment, devices, or systems that require an advanced level of reliability.**

Hioki is not liable for any bodily injury or infrastructure interruptions that arise as a result of the use of the product in such applications.

NOTICE



- **Do not use the LR8450-01 or its wireless modules in proximity to other devices that use the same frequency band, for example Wi-Fi® or Bluetooth® devices.**

Doing so may result in communications instability or affect the operation of other devices.



- **Install the LR8450-01 and any wireless modules (Z3230 Wireless LAN Adapters) so that there are no obstructions (walls, metal materials, etc.) between them.**

Failure to do so may result in communications instability or reduce the communications range.

- Communications between the LR8450-01 and its wireless modules (Z3230 Wireless LAN Adapters) are encrypted, but the confidentiality of information sent and received is not guaranteed. Hioki is not liable for any leaks of measured values caused by wireless communications.
- The LR8450-01 and its wireless modules (Z3230 Wireless LAN Adapters) give off radio-wave radiation. Use of radio communications requires a permit in the country of use. Use of the instrument outside the countries and regions listed in the included "Precautions Concerning Use of Equipment That Emits Radio Waves" may constitute a violation of applicable laws, resulting in penalties.
- Placing the LR8450-01 and its wireless modules (Z3220 Wireless LAN Adapters) on the floor or ground will reduce the communications range. The communications range can be extended by moving the devices away from the floor or ground, for example by placing them on a workbench or stand.

How to Use This Manual

How to open screens

- SET** : SET key
- Channel** : Main tab
- Individual** : Sub tab

Step number

Numbers are the same as those used in the instructions.

Selections and explanations

Indicates the selections that can be made by pressing the **ENTER** key and explains them. The mark indicates the default setting.

Measuring voltage

This section describes how to configure settings on the individual settings screen when measuring voltage.

You can use **[Input]** on the setting list screen to configure the settings. (See p.50.)

Applicable modules: U8550, U8551, U8552, U8553, U8554, LR8530, LR8531, LR8532, LR8533, LR8534

SET > **Channel** > **Individual**

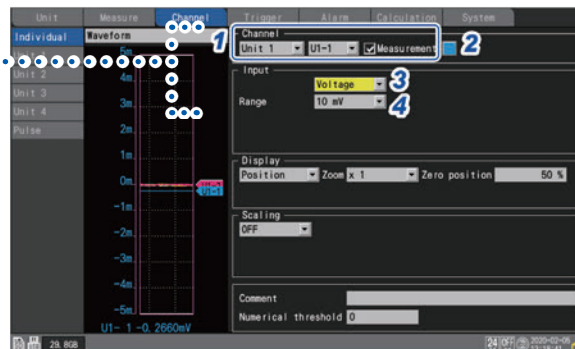

- 1** Select the module and channel to configure and select the checkbox. Measurement will not be performed for channels whose checkboxes are not selected.
- 2** Select the waveform display color.

(OFF), 24 colors
 Select if you wish to measure the channel but not to display its waveform or numerical values on the screen.

- 3** Set the input type to **[Voltage]**.
 For the U8553 and LR8533, the setting cannot be changed from **[Voltage]**.
- 4** Under **[Range]**, select the measurement range as appropriate for the measurement target.

(For the U8550, U8551, U8552, LR8530, LR8531, or LR8532)
 10 mV, 20 mV, 100 mV, 200 mV, 1 V, 2 V, 10 V, 20 V, 100 V, 1 to 5 V

(For the U8553 or LR8533 High Speed Voltage Unit)
 100 mV, 200 mV, 1 V, 2 V, 10 V, 20 V, 100 V, 1 to 5 V

(For the U8554 or LR8534 Strain Unit)
 1 mV, 2 mV, 5 mV, 10 mV, 20 mV, 50 mV, 100 mV, 200 mV

Introduction to Convenient Functionality

This section introduces convenient functionality provided by the instrument and indicates where to look for more information.



When you want to capture sudden phenomena

It's hard to search for anomalies in a long recording. You want to record only anomalies.

▷ Trigger function

See "2 Trigger Function" in the Instruction Manual.

Specify the level that indicates an anomaly so that the instrument starts recording when that condition is satisfied.

You can use the trigger function to control when to start and stop recording.

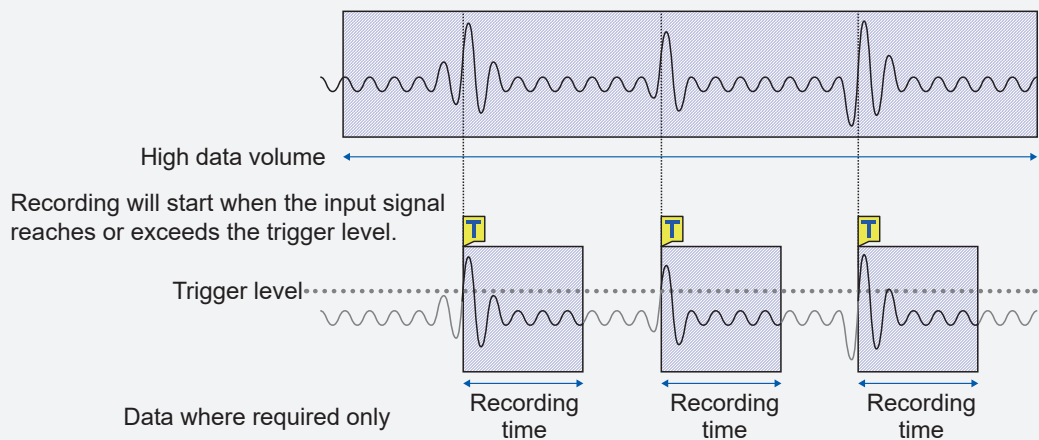

When you want to view data before an issue occurs

Why did the issue occur? You want to view the waveform before an anomaly occurred.

▷ Pre-trigger function

See "2.2 Enabling the Trigger Function" in the Instruction Manual.

You can also record data before trigger conditions are satisfied.

Data preceding an anomaly is useful when you need to analyze the cause of an issue.

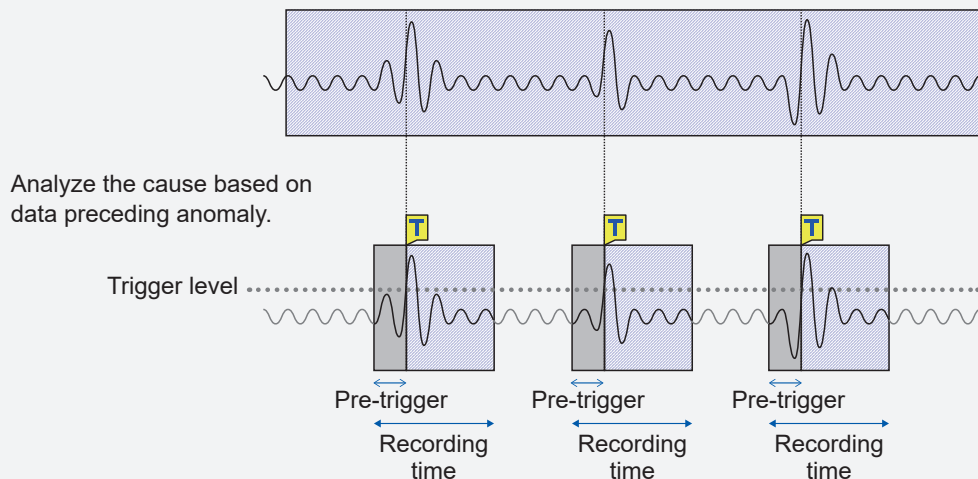



When you want to view waveforms, numerical values, and comments at the same time

You want to view waveforms and numerical values at the same time. You want to display comments that identify the data.

▷ Switching the waveform screen

See “Waveform display” in the Instruction Manual.

You can switch the waveform screen with the **WAVE** key.

This feature also lets you display numerical values and comments along with waveforms.

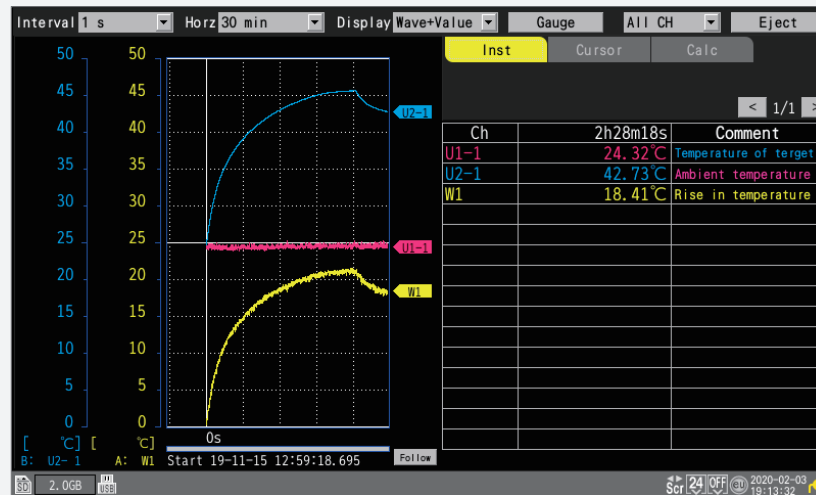

When you want to read values from waveforms

You want to read values from waveforms. You also want to ascertain the potential difference or time difference between two points.

▷ A/B cursors

See “1.12 Using the A/B Cursors” in the Instruction Manual.

The A/B cursors let you read measured values and times from waveforms.

You can also read the potential difference and time difference between the A cursor and the B cursor.

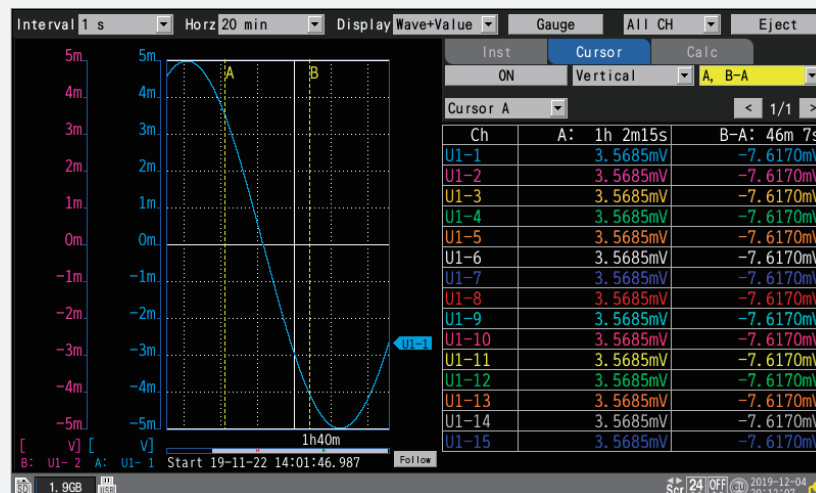



When you want to ascertain the characteristics of the measured waveform

You want to ascertain the characteristics of a waveform, for example its maximum and minimum values.

▷ Numerical calculation function

See “6.1 Performing Numerical Calculations” in the Instruction Manual.

This function lets you ascertain the characteristics of measured waveforms using numerical calculations.

You can calculate any 10 values out of 13 available choices, including maximum value, minimum value, and average value.

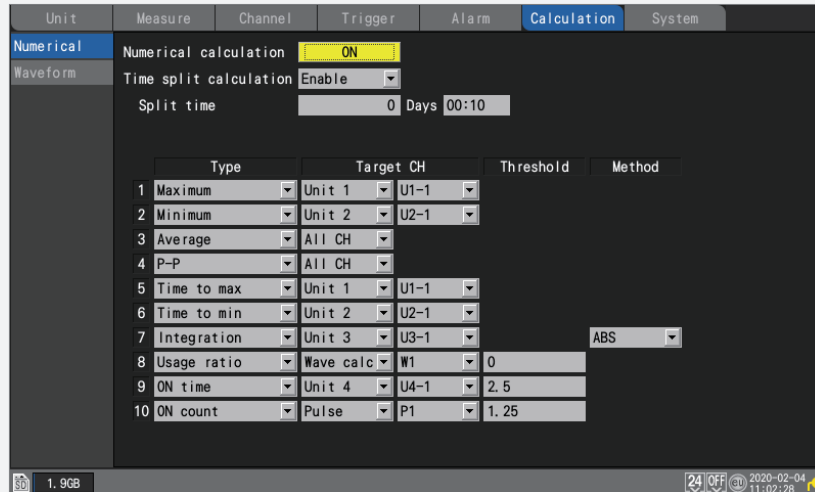

When you want to record only the rise in temperature

You want to know how much a temperature reading rose from the ambient temperature.

▷ Waveform calculation function

See “6.2 Performing Waveform Calculations” in the Instruction Manual.

This function lets you measure the temperature of the measurement target using U1-1 and the ambient temperature using U1-2.

You can record the measurement target’s rise in temperature using the following waveform calculation: $W1 = U1-1 - U1-2$

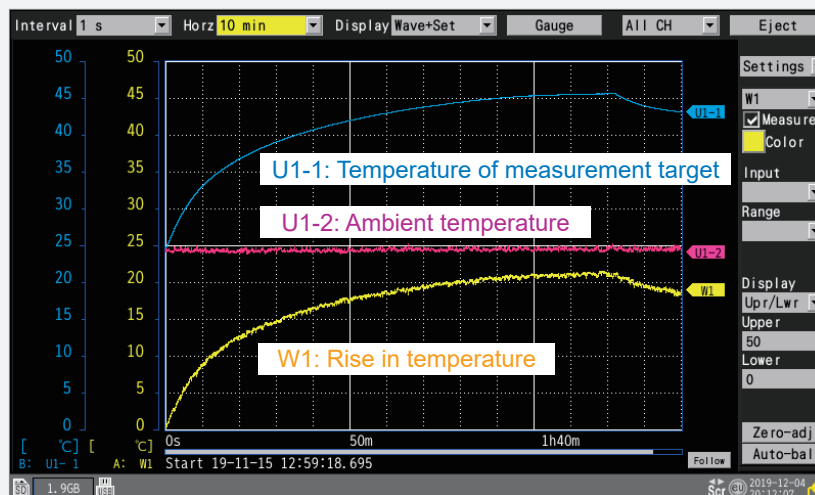



When you want to stop a piece of equipment if it becomes too hot

You want to monitor the temperature of a piece of equipment and halt its operation if it becomes too hot.

▷ Alarm output function

See "4 Alarm (Alarm Output)" in the Instruction Manual.

This function lets you set a threshold and then output an alarm signal if the input signal reaches or exceeds that threshold.

Alarm output can be used to communicate the alarm to a piece of equipment or to control a warning lamp.

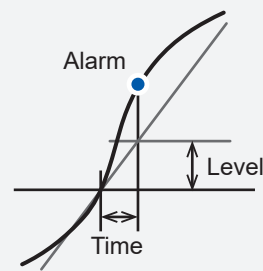
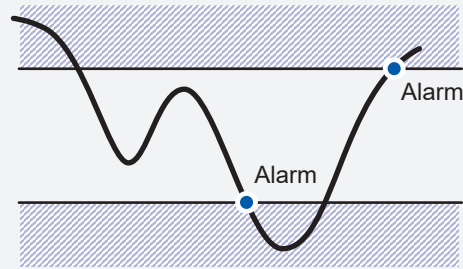

Slope

When the rate of change of the input signal continues to exceed the specified rate of change per time during the period of the set recording time, an alarm will output.



When you want to check the status of measurement from your office

Your measurement site and office are connected by a LAN. You want to check the status of measurement using a computer in your office.

▷ HTTP server

See "9.5 Performing Remote Measurement with the HTTP Server" in the Instruction Manual.

This function lets you control the LR450 remotely using a computer in an office while measurement continues in the field.

You can view data in real time, and you can also capture waveform data.





When you want to embed the LR8450 in another piece of equipment

You want to mount the LR8450 on a wall.

▷ **Z5040 Fixed Stand**

See “Options (sold separately)” (p.5).

You can mount the instrument on another piece of equipment using the optional Z5040 Fixed Stand.

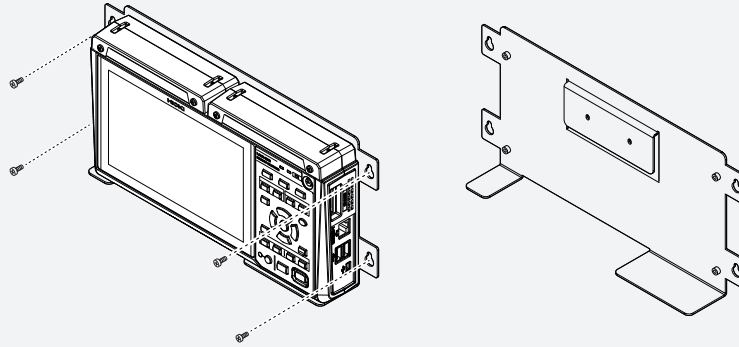

When you want to clear the settings from the previous user

The settings configured by the previous user could cause unintended operation. You want to clear those settings.

▷ **Initialization (system reset)**

See “Initializing (resetting) the system” in the Instruction Manual.

When multiple users are sharing the instrument, it is recommended to configure settings after first initializing the instrument.



When you want to measure temperatures at multiple points using thermocouples

You want to measure 300 or more temperature readings at the same time.

▷ **U8552 Voltage/Temp Unit, LR8532 Wireless Voltage/Temp Unit**

See “1.3 Options” (p.32).

You can measure 330 temperature readings using four U8552 modules and seven LR8532 modules.



When you want to measure temperature with a high degree of precision

You want to measure temperature with a higher degree of precision than is possible with thermocouples.

▷ **U8551 Universal Unit, LR8531 Wireless Universal Unit**

See “1.3 Options” (p.32).

You can measure temperature using a resistance bulb with the U8551 and LR8531.



When you want to measure voltage at a sampling rate of 1 ms

You want to record output from an amp's built-in sensor at high speed.

▷ **U8553 High Speed Voltage Unit, LR8533 Wireless High Speed Voltage Unit**

See "1.3 Options" (p.32).

You can record sensor output at 1 ms sampling and 16-bit high resolution.



When you want to measure strain at a sampling rate of 1 ms

You want to record strain gage-type converter output, for example pressure or acceleration.

▷ **U8554 Strain Unit, LR8534 Wireless Strain Unit**

See "1.3 Options" (p.32).

The U8554/LR8534 has a built-in bridge box. You can record data at 1 ms sampling and 16-bit high resolution.



When you want to make measurements at a location that has no power outlets

You want to make measurements at a location that has no power outlets. You want to power the LR8450 using batteries.

▷ **Z1007 Battery Pack**

See "Z1007 Battery Pack" (p.33).

You can power the instrument or wireless modules with the Z1007 Battery Pack.



When you want to use a sensor that requires a power supply

You want to supply power to the Z2000 Humidity Sensor or other sensor.

▷ **Voltage output terminal**

See "Connecting voltage output" (p.61).

You can output +5 V DC, +12 V DC or +24 V DC as a sensor power supply from the instrument.



When you want to transport the instrument in a case

You want to transport the LR8450 and its accessories in a case.

▷ **C1012 Carrying Case**

See "C1012 Carrying Case" (p.34).

You can store the instrument and seven wireless modules in this case.



When you want to read sensor values directly

You want to display values from the Humidity Sensor, which generates output ranging from 0 V to 5 V, as humidity values (% RH).

▷ **Scaling function**

See “1.5 Using the Scaling Function” in the Instruction Manual.

You can use the scaling function to convert voltage values to humidity values.

By setting the conversion ratio to 20 and the unit to “%RH,” you can display values as humidity values.



When you want to record a current of 4 to 20 mA from an instrumentation device

▷ **When you connect a 250 Ω resistance to the input terminal, you can record 4 mA as 1 V and 20 mA as 5 V.**

See “Connecting wires to a screw-type terminal block” (p.50).



When you want to save waveform data in one-hour increments

▷ **Using the auto save function, you can set [File splitting] to [Enable] and [Split time] to [1 h].**

See “Auto save (real-time save)” in the Instruction Manual.



When you want to save the maximum value, minimum value, and average value every hour

▷ **You can perform calculations as the specified time interval and save the results using the numerical calculation function.**

See “6.1 Performing Numerical Calculations” in the Instruction Manual.



When you want to control the LR8450 with an external signal

▷ **You can control when to start and stop measurement using a signal input to the external control terminal.**

See “8 External Control (EXT. I/O)” in the Instruction Manual.

1.1 Instrument Overview and Features

The LR8450/LR8450-01 is a multichannel logger that can measure physical properties such as temperature, voltage, and strain when used in combination with measurement modules. Two categories of measurement modules are available: plug-in modules that can be plugged directly into the instrument and wireless modules that can send data wirelessly.

● Choose the modules that are right for your application from 10 different types.

The LR8450 can accommodate plug-in modules.

The LR8450-01 can accommodate modules consisting of both plug-in modules and wireless modules.

Recommended modules

Feature	Plug-in modules	Wireless modules
Record temperature at a sampling rate of 10 ms (using thermocouples)	U8550	LR8530
Record temperature with a high degree of precision (using resistance bulbs)	U8551	LR8531
Record multiple channels of temperature data (using thermocouples)	U8552	LR8532
Record voltage data at a sampling rate of 1 ms	U8553	LR8533
Record strain data at a sampling rate of 1 ms	U8554	LR8534

See “Plug-in modules” (p.29) “Wireless modules” (p.30).

● Add or remove modules according to the number of channels.

Both the LR8450 and LR8450-01 can accommodate up to four plug-in modules.

The LR8450-01 can also record data using only wireless modules, even if no plug-in modules have been installed.

Number of modules and channels that can be used

Model number	Plug-in modules	Wireless modules	Number of channels that can be measured
LR8450	4	–	120
LR8450-01	4	7	330 (plug-in: 120; wireless: 210)

See “2.1 Connecting Plug-in Modules” (p.38)

● **Measure signals at a sampling rate of 1 ms, even when modules are added.**

Adding modules, each of which incorporates an A/D converter, does not cause the reduction of the data refresh rate (sampling speed).

You can perform measurement at different data refresh rates appropriate for every module. See “Measurement module data refresh intervals” in the Instruction Manual.

Setting example

- Control signals are recorded at a high sampling rate of 1 ms using the U8553 High Speed Voltage Unit.
- Multi channels of temperatures are recorded at a sampling rate of 1 s using the U8552 Voltage/Temp Unit.

(The U8552 can use a relatively low sampling rate, allowing the filter to set a lower cutoff frequency. Using the U8552 can eliminate lower-frequency noise.)

● **Perform strain measurement.**

You can measure multiple channels of strain data using the Strain Unit.

The instrument has a built-in bridge box, allowing it to support a variety of connection methods.



See “Connecting a strain gage or strain gage-type converter” (p.56)

1.2 Part Names and Functions; Screens



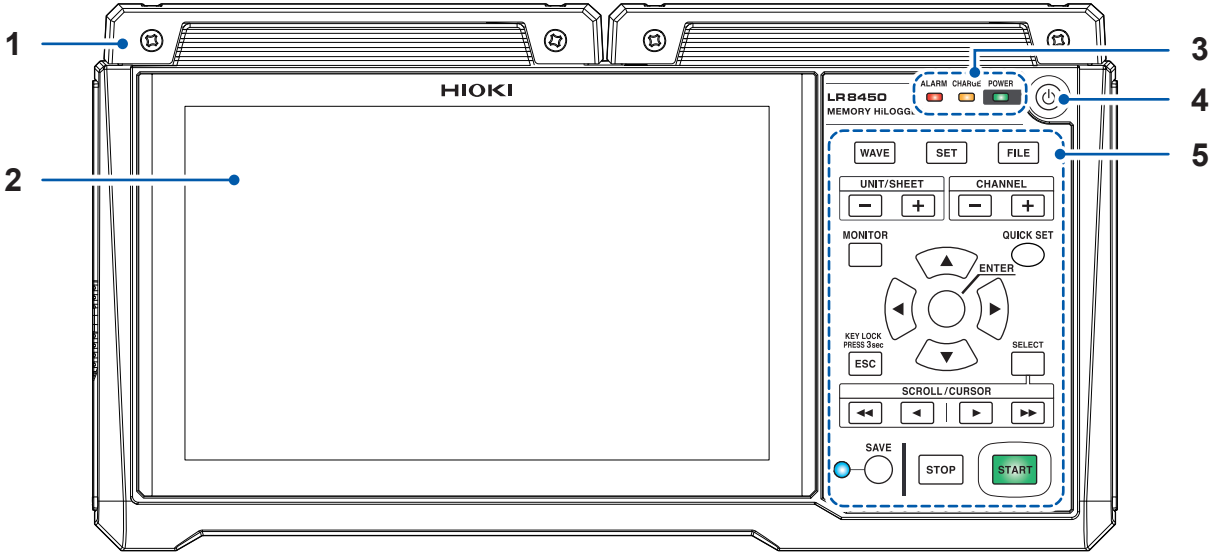





LR8450/LR8450-01 Memory HiLogger

Front

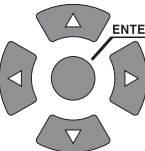

No.	Name	Functionality	See
1	Connector covers	Inside each cover are connectors for plug-in modules. Affix the covers when not installing plug-in modules. The covers can also be used as connector covers for plug-in modules.	p. 38
2	Display	The instrument features a 7-inch TFT color LCD.	–
3	POWER LED	 Lights up when the instrument is on.	p. 64
	CHARGE LED	 Lights up when the instrument is charging.	p. 44
	ALARM LED	 Lights up when an alarm occurs.	Instruction Manual
4	Power key	Turns the instrument on or off.	p. 64
5	Key controls	See following page.	–

Key controls

Key	Name	Functionality	See
	WAVE key	Displays the waveform/value screen. Allows you to view waveforms and numerical values.	Instruction Manual
	SET key	Displays the settings screen. Allows you to configure function settings.	p. 70
	FILE key	Displays the file screen. Allows you to perform file operations.	Instruction Manual
	UNIT/SHEET keys	Allows you to select the module or sheet and switches between sub tabs.	p. 72
	CHANNEL keys	Switches channels.	
	MONITOR key	Displays the monitor. Allows you to check the current input channel.	Instruction Manual
	QUICK SET key	Launches the configuration navigator to display the connection guide.	Instruction Manual
	Left Arrow, Right Arrow, Up Arrow, and Down Arrow keys	Moves the focus* on the screen up and down. *: Refers to the active item. The background of the selected item will turn yellow.	p. 72
	ENTER key	Accepts the settings you have made. Moves down a level.	
	ESC key	Cancels the operation. On the settings screen, moves up a level. You can disable keys by pressing and holding ESC key for at least 3 seconds.	p. 71
	SELECT key	Toggles between waveform scrolling and A/B cursor movement. On the file screen, opens a menu of file operations.	Instruction Manual
	SCROLL/CURSOR keys	Scrolls the waveform or move the A/B cursors.	
	SAVE key	Saves the data. The LED next to the key will turn blue while data is being saved.	p. 73
	START key	Starts measurement. The key will turn green while measurement is in progress.	
	STOP key	Stops measurement.	

Rear

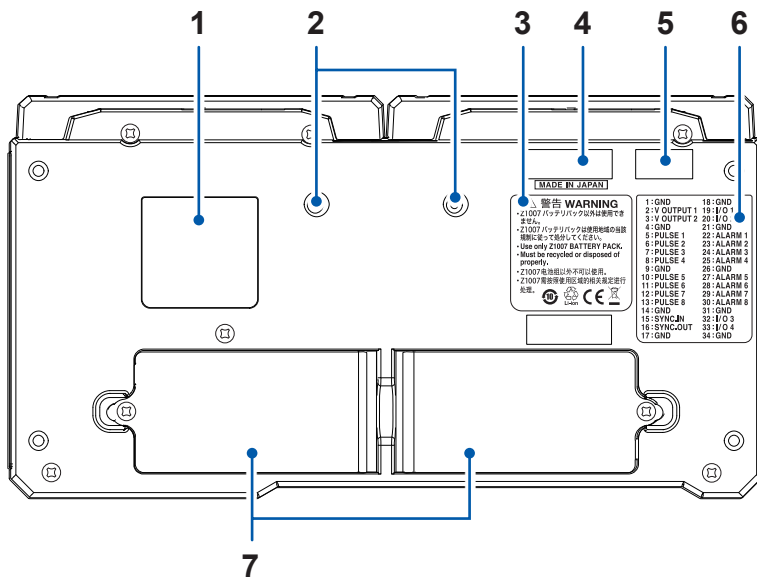

No.	Name	Functionality	See
1	Wireless certification number	Indicates the wireless certification number. (LR8450-01 only)	–
2	Installation screw holes	The screws can be used for attaching the Z5040 Fixed Stand, which allows the product to mount on a wall.	–
3	Warning	Contains important information about the instrument.	p.40
4	Serial number	The serial number consists of nine digits. The first two digits indicate the year of manufacture, while the second two digits indicate the month of manufacture. Do not remove this sticker as the number is important. Communicate this number when you contact your authorized Hioki distributor or reseller. This label also indicates whether the instrument is an LR8450 or an LR8450-01.	–
5	MAC address	Indicates the MAC address assigned to your instrument. Do not remove this sticker as the number is important.	–
6	External control terminal names	Indicates the names of the external control terminals on the left side of the instrument.	p.63
7	Battery compartments	Provides internal space for the Z1007 Battery Pack. (Up to 2)	p.40

Left side

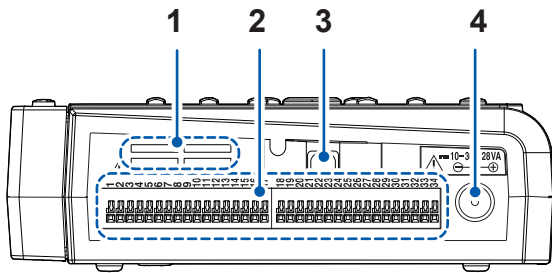

Right side

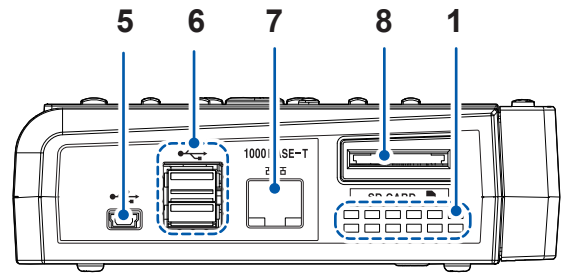

No.	Name	Functionality	See
1	Air vents	Provides ventilation to keep the instrument from reaching too high an internal temperature.	p.9
2	External control terminals*	Allows you to control the instrument using external signals. Outputs alarm signals.	p.63
3	Cable hook	Pass the Z1014 AC Adapter's cable through this hook to keep it from being pulled out.	p.46
4	AC Adapter connection terminal	Connect the included Z1014 AC Adapter here.	p.45
5	USB cable connector	Connect the included USB cable here. (USB 2.0 Mini B)	Instruction Manual
6	USB connector	Connect a USB Drive or keyboard here. (USB 2.0 Type A)	p.68
7	LAN connector	Connect a LAN cable here. (100Base-TX/1000Base-T)	Instruction Manual
8	SD card slot	Insert an optional SD Memory Card here.	p.67

*: How to check the pin assignments of the external control terminals
Press the **QUICK SET** key, and choose **[External control terminal connection guide]**. Names of the external control terminals will be displayed.

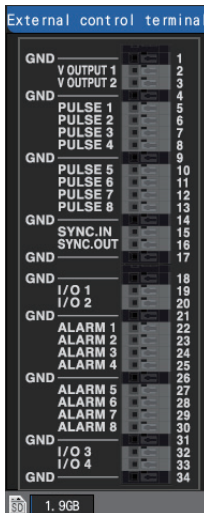

Function name	Pin number	Signal name	See
Pulse input	5, 6, 7, 8, 10, 11, 12, 13	PULSE 1 to PULSE 8	p.59
Warning output	22, 23, 24, 25, 27, 28, 29, 30	ALARM 1 to ALARM 8	p.60
Voltage output	2, 3	V OUTPUT 1 V OUTPUT 2	Instruction Manual
External control	19, 20, 32, 33	I/O 1 to I/O 4	Instruction Manual
GND	1, 4, 9, 14, 17, 18, 21, 26, 31, 34	GND	-
(Reserved)	15, 16	SYNC.IN, SYNC.OUT	-

See "8 External Control (Ext. I/O)" in the Instruction Manual.

Screen and icons

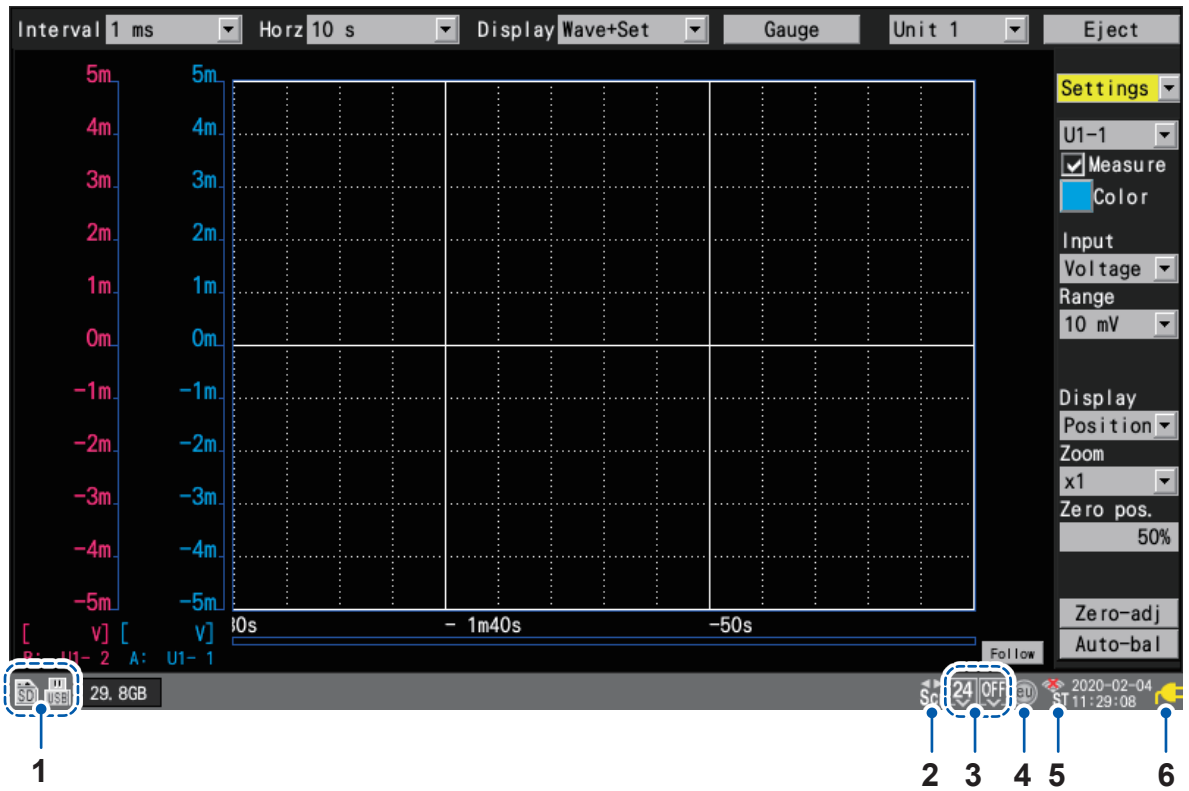









1

Overview

No.	Item	Icon	Description	See
1	Media* ¹		An SD Memory Card has been inserted.	p.67
			A USB Drive has been inserted.	
2	SCROLL CURSOR		Tapping the SCROLL/CURSOR keys moves the waveforms.	Instruction Manual
			Tapping the SCROLL/CURSOR keys moves the A/B cursors.	
3	Voltage output* ²		No voltage is being output from the voltage output terminals.	p.61
			A voltage of 5 V DC is being output from the voltage output terminals.	
			A voltage of 12 V DC is being output from the voltage output terminals.	
			A voltage of 24 V DC is being output from the voltage output terminals.	
4	Scaling		Scaling is enabled for one or more channels.	Instruction Manual

*1: The icon of media chosen as the priority save destination (left) and its available space (right) are displayed.

*2: The left icon indicates the state of the voltage output terminal 1: the right, that of the voltage output terminal 2.

No.	Item	Icon	Description	See
5	Wireless LAN		The modules are connected in station mode.	Instruction Manual
			The modules are disconnected in station mode.	
6	Instrument power* ³		The instrument is being powered by the AC Adapter.	p.45
			The instrument is operating on battery power (fully charged).	p.40
			The instrument is operating on battery power.	
			The instrument is operating on battery power. The battery starts to run out. Connect the AC adapter to charge the battery.	
			The instrument is operating on battery power. The battery has run out. Connect the AC adapter to charge the battery.	
			The instrument is being powered by the AC Adapter. The battery is being charged.	
			A battery anomaly has occurred. Immediately stop the use of the instrument and remove the Battery Packs.	

*3: Two icons will appear if two Z1007 Battery Packs have been inserted.

The icon on the right indicates the status of the Battery Pack on the right when the instrument is viewed from the front (looking at the LCD screen), while the icon on the left indicates the status of the Battery Pack on the left.

Plug-in modules

Figures show the U8550 Voltage/Temp Unit.

Front

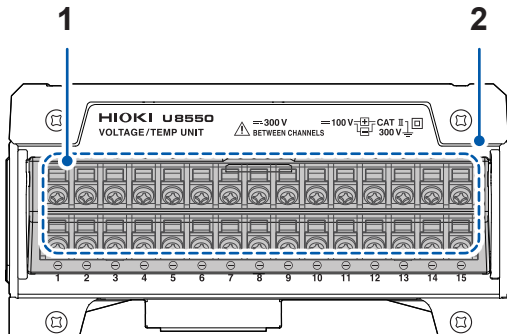

Top

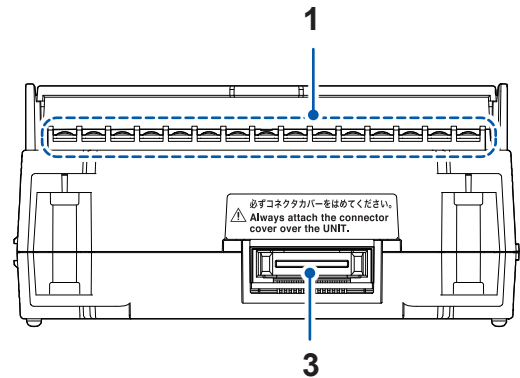

Rear

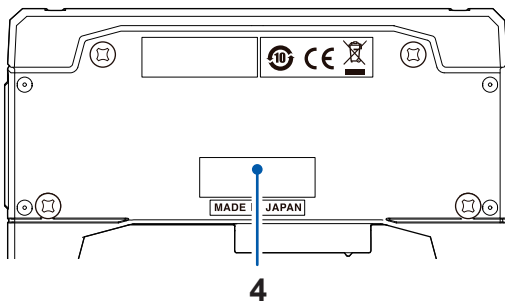

Bottom

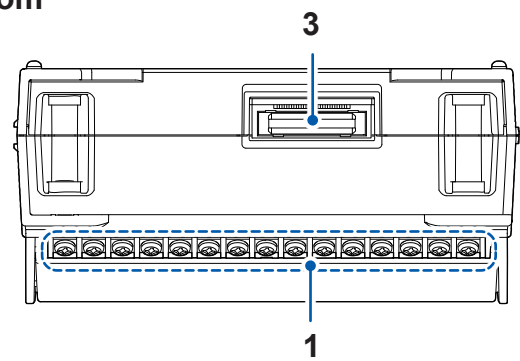

1

Overview

No.	Name	Functionality	See
1	Input terminals	Provides input terminals for each channel.	p.47
2	Terminal block cover	Close the cover during measurement.	—
3	Connector	Used for module expansion. Attach the connector cover to any unused connectors.	p.38
4	Serial number	The serial number consists of nine digits. The first two digits indicate the year of manufacture, while the second two digits indicate the month of manufacture. Do not remove this sticker as the number is important. Communicate this number when you contact your authorized Hioki distributor or reseller.	—

If four plug-in modules have been installed

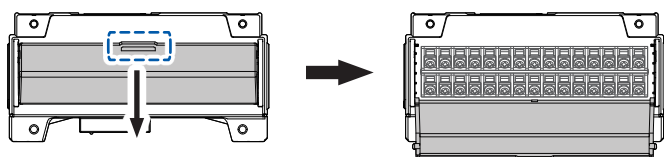
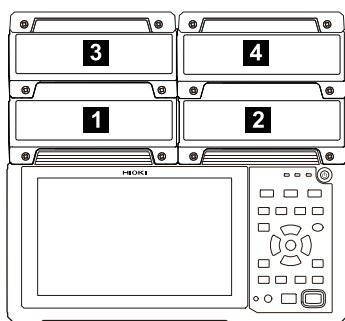

Terminal block covers open toward you.

Wireless modules

Figures show the LR8530 Wireless Voltage/Temp Unit.

Front

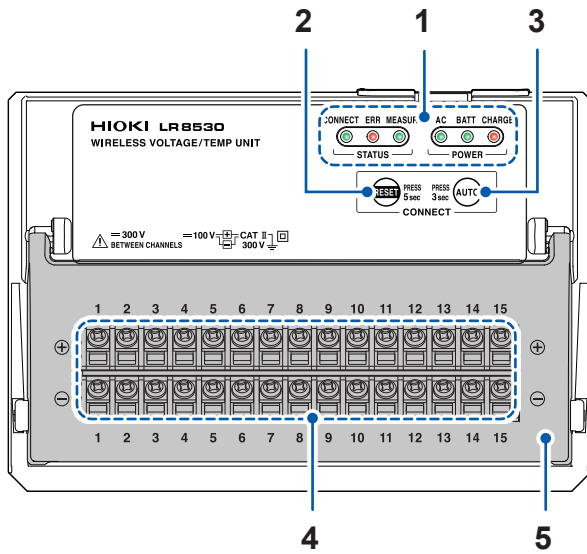

Rear

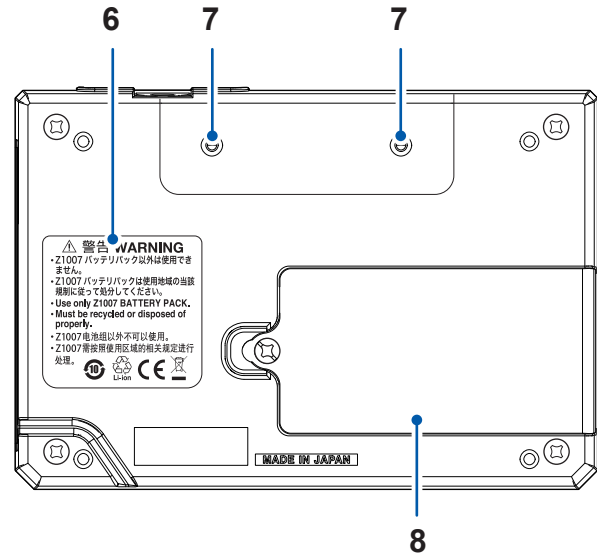

No.	Name	Functionality	See	
1	CONNECT LED	<p>STATUS</p>	Indicates the status of communications with the LR8450-01.	
	ERR LED			Indicates an error state.
	MEASURE LED			Indicates the measurement status.
	AC LED	<p>POWER</p>	Lights up when the instrument is being powered by the AC Adapter or by an external power supply.	
	BATT LED			Lights up when the instrument is operating on battery power.
	CHARGE LED			Lights up when the Battery Pack is being charged.
2	RESET key	<p>CONNECT</p>	Resets the wireless module's communications settings.	
3	AUTO key		Automatically configures communications settings between the LR8450-01 and the wireless modules.	
4	Input terminals	Provides input terminals for each channel.	—	
5	Terminal block cover	Close the cover during measurement.	—	
6	Warning	Contains important information about the instrument.	—	
7	Installation screw holes	Accommodates screws for use in mounting the module on a board or wall.	—	
8	Battery compartment	Provides internal space for the Z1007 Battery Pack.	—	

Top

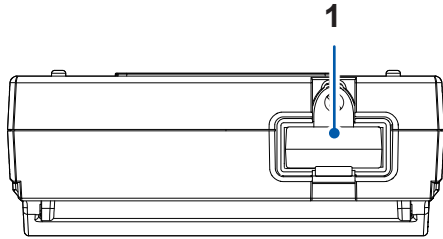

Right side

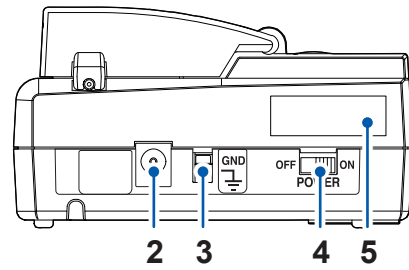

No.	Name	Functionality	See
1	Wireless LAN Adapter	Connect the Z3230 Wireless LAN Adapter (wireless module accessory) here.	-
2	AC Adapter connection terminal	Connect the Z1008 AC Adapter (an included accessory) here.	-
3	GND	Serves as the function ground terminal.	-
4	POWER switch	Turns the instrument on or off.	-
5	Serial number	The serial number consists of nine digits. The first two digits indicate the year of manufacture, while the second two digits indicate the month of manufacture. Do not remove this sticker as the number is important. Communicate this number when you contact your authorized Hioki distributor or reseller.	-

1.3 Options

There are a total of 10 measurement modules, including 5 plug-in modules and 5 wireless modules. For detailed specifications, see “10 Specifications” in the Instruction Manual.

Plug-in modules

Plug-in modules can be used with either the LR8450 or the LR8450-01.

Instrument name		Measurement target	Number of channels	Maximum sampling speed
U8550	Voltage/Temp Unit	Voltage, temperature (thermocouple), humidity	15	10 ms
U8551	Universal Unit	Voltage, temperature (thermocouple/resistance bulb), resistance, humidity	15	10 ms
U8552	Voltage/Temp Unit	Voltage, temperature (thermocouple), humidity	30	20 ms*
U8553	High Speed Voltage Unit	Voltage	5	1 ms
U8554	Strain Unit	Voltage, strain	5	1 ms

*: When using with 15 channels or less, 10 ms.

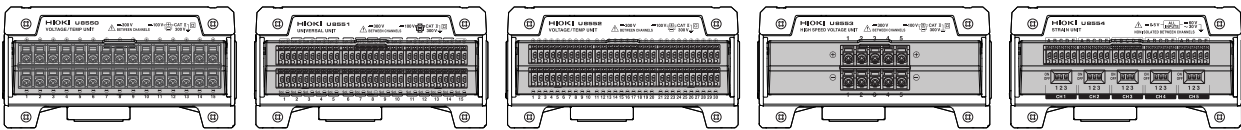

Wireless modules

Wireless modules can only be used with the LR8450-01.

Instrument name		Measurement target	Number of channels	Maximum sampling speed
LR8530	Wireless Voltage/Temp Unit	Voltage, temperature (thermocouple)	15	10 ms
LR8531	Wireless Universal Unit	Voltage, temperature (thermocouple/resistance bulb), resistance, humidity	15	10 ms
LR8532	Wireless Voltage/Temp Unit	Voltage, temperature (thermocouple)	30	20 ms*
LR8533	Wireless High Speed Voltage Unit	Voltage	5	1 ms
LR8534	Wireless Strain Unit	Voltage, strain	5	1 ms

*: When using with 15 channels or less, 10 ms.

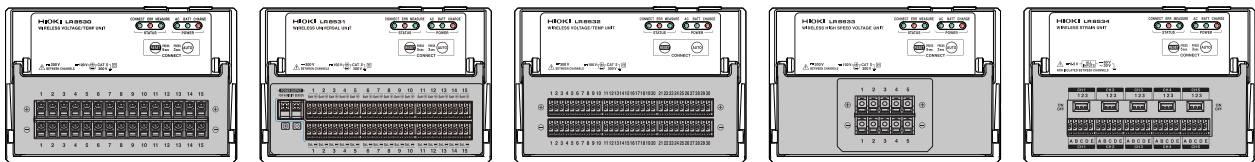

Other options

1

Overview

Z1014 AC Adapter (LR8450/LR8450-01 accessory)

Z1008 AC Adapter (wireless module accessory)

The LR8450/LR8450-01 ships with the Z1014 AC Adapter.

Wireless modules ship with the Z1008 AC Adapter.

These adapters allow the LR8450/LR8450-01 and wireless modules to be powered by commercial power. (AC power)

- Rated supply voltage (100 to 240 V AC)
- Rated power supply frequency (50/60 Hz)

When using both the AC Adapter and Battery Pack, the AC Adapter has priority in powering the instrument or module.

When power from the AC Adapter is interrupted, the instrument or module will immediately switch to battery power.



Z1007 Battery Pack

The optional Z1007 Battery Pack can be used to operate the instrument when commercial power, which enables through the AC Adapter the instrument to operate, cannot be used. In addition, it can be used as a backup power supply in the event of a power outage.

See “Installing a Battery Pack” (p.40).



Z3230 Wireless LAN Adapter (wireless module accessory)

The Wireless LAN Adapter comes with the LR8530, LR8531, LR8532, LR8533, and LR8534.

It is used by attaching it to the wireless module.

Z2000 Humidity Sensor

The Z2000 Humidity Sensor can be connected to the U8550, U8551, U8552, or LR8531 to measure humidity.

The Z2000 requires a power supply.

With the U8550, U8551, and U8552, the instrument’s VOUTPUT 1 and 2 power supply output terminals can be used to supply power to the Z2000. With the LR8531, connect the Z2000 to the module’s Humidity Sensor power supply terminal.

The Z2000 has a cable length of 3 m.



Z5040 Fixed Stand

You can mount the instrument on a wall or other surface using the optional Z5040 Fixed Stand.

For more information about how to install the stand, see the Instruction Manual that comes with the Z5040.

Use the screws that come with the Z5040 (M3×5 mm) to attach the instrument to the stand.



C1012 Carrying Case

The optional C1012 Carrying Case provides a convenient way to transport the instrument. The C1012 can accommodate the logger (with up to four plug-in modules) as well as wireless modules (up to seven).



Z4001 SD Memory Card (2 GB), Z4003 SD Memory Card (8 GB), Z4006 USB Drive (16 GB)

You can save measurement data and settings to an SD Memory Card or USB Drive.

Proper operation of the instrument with SD memory cards and USB drives other than options provided by Hioki is not guaranteed.



SF4101/SF4102 Remote Measurement Service GENNECT Remote

Hioki's SF4101/SF4102 Remote Measurement Service (fees apply) allows you to control and download data from instruments installed in a remote location.

The service offers the following functionality:

- Remote monitor/remote logging function
Download measured values from the instrument to the cloud and review them on a computer or smartphone.
 - License verification function
Check the license expiration date, remaining data allowance, SD Memory Card capacity, and other information.
 - Remote control function (secure HTTP tunnel function)
Use the instrument's HTTP server function to control it remotely.
 - Remote file acquisition function
Remotely acquire measurement files saved on the instrument's SD Memory Card.
-

1.4 Measurement Process

This section describes how to make measurements using the instrument.

1 Prepare to use the instrument. See “2 Making Connections (Preparing for Measurement)” (p.37).

If using one or more plug-in modules, install them in the instrument. Connect either the AC Adapter or a charged Battery Pack and turn on the instrument and any wireless modules.

2 Register any wireless modules (LR8450-01 only).

Register any wireless modules you plan to use with the instrument (up to seven can be registered). Information about registered modules will be retained when the instrument is turned off.

3 Prepare for measurement (placement and wiring). See “2.4 Connecting the Cables” (p.47).

Connect thermocouples, Humidity Sensors, and other components to the measurement modules' terminal blocks.

4 Turn on the instrument.

5 Set the measurement conditions. See “1.2 Setting Measurement Conditions” in the Instruction Manual.

Set the recording interval and recording time on the instrument's measurement settings screen. Press the **SET** key to display the **[Measure]** setting screen.

6 Set the input channels. See “1.3 Configuring Input Channels” in the Instruction Manual.

Configure the input channels for parameters such as voltage and temperature. Press the **SET** key to display the **[Channel]** setting screen.

7 Perform zero adjustment. See “1.8 Performing Zero Adjustment” in the Instruction Manual.

Correct for shift in the input module's potential. Set the instrument's reference potential to 0 V.

8 Stop/start measurement. See “Starting and stopping measurement” (p.73).

Press the **START** key to start measurement.

Press the **STOP** key to stop measurement.

(Measurement can also be stopped automatically at the set recording time.)

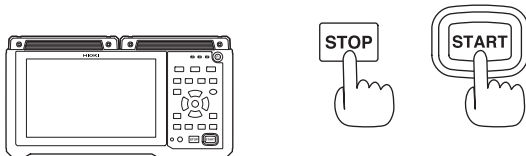

9 Observe waveform data. See “1.11 Observing Waveforms” in the Instruction Manual.

You can move through the waveforms along the time (horizontal) axis with the **SCROLL** keys. You can move through the waveforms even while measurement is in progress. You can check waveforms acquired in the past while measurement is in progress.

10 Read values from waveform data. See “1.12 Using the A/B Cursors” in the Instruction Manual.

The A/B cursors let you read values from waveforms.

11 Save the data. See “3.3 Saving Data” in the Instruction Manual.

You can save measurement data, settings, screen images, and other information with the **SAVE** key.

You can load previously saved data into the instrument. (Screen images cannot be loaded.)

Making Connections (Preparing for Measurement)



This chapter describes how to prepare for measurement. Use either the AC Adapter or Battery Pack to power the instrument. You can rest secure in the event of an abrupt power outage by installing a Battery Pack even while using the AC Adapter.

Install and connect modules and cables according to your measurement targets.

You can choose either an SD Memory Card or a USB Drive as storage media.

2.1 Connecting Plug-in Modules	p. 38
2.2 Installing a Battery Pack	p. 40
2.3 Connecting the AC Adapter.....	p. 45
2.4 Connecting the Cables.....	p. 47
Connecting voltage cables and thermocouples.....	p. 50
Connecting resistance bulbs	p. 52
Connecting the Humidity Sensor.....	p. 52
Connecting a resistor	p. 55
Connecting a strain gage or strain gage-type converter	p. 56
Connecting pulse input.....	p. 59
Connecting alarm output	p. 60
Connecting voltage output.....	p. 61
Connecting external control signals	p. 63
2.5 Turning the Instrument On and Off	p. 64
2.6 SD Memory Card and USB Drive.....	p. 65

2.1 Connecting Plug-in Modules

You can connect up to four optional plug-in modules to one LR8450/LR8450-01. Add modules according to the number of channels necessary for measurement.

WARNING

- Turn off the instrument and disconnect any cables before connecting or removing any plug-in modules.



- When not using a plug-in module slot, secure the connector cover over the instrument's module connector with the screws.

Failure to do so could cause electric shock or damage the instrument or plug-in module.

Compatible modules: U8550, U8551, U8552, U8553, U8554

You will need: A Phillip's head screwdriver (No. 2)

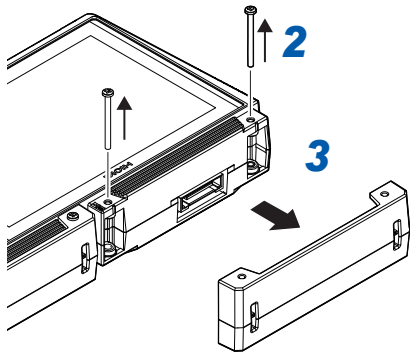

- 1** Turn off the instrument and disconnect the AC Adapter.

- 2** Remove the two screws from the instrument's connector cover.

- 3** Remove the connector cover.
Store the removed connector cover for future use.

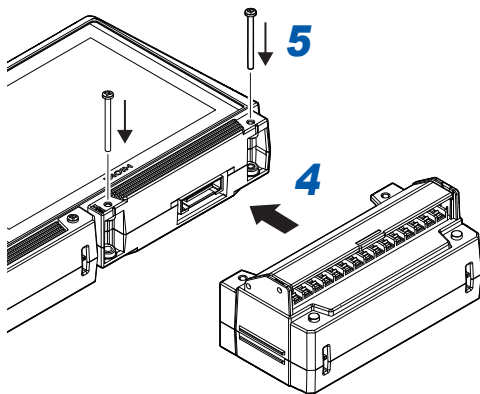

- 4** Connect the plug-in module to the connector on the instrument.

- 5** Insert and tighten the two screws removed in step **2**.

If installing multiple plug-in modules, do so as indicated in the diagram below. Do not remove the connector covers for any plug-in module slots not in use.

When connecting 1 plug-in module

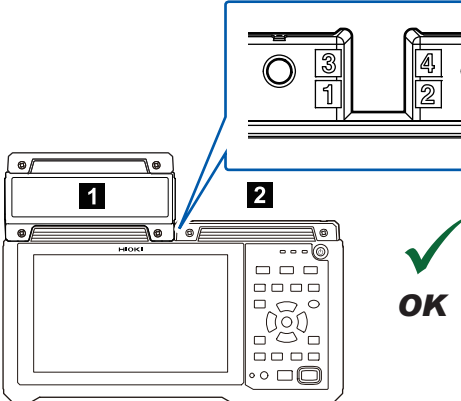

Connect the module to slot **1** or **2**.

When connecting 3 plug-in modules

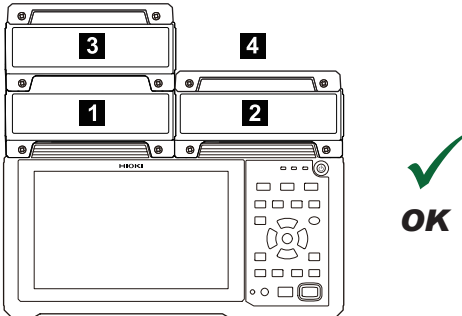

Connect the modules to slots **1**, **2**, and **3** or **1**, **2**, and **4**.

Connecting plug-in modules as shown below will cause an error to be displayed on the screen.

When connecting 2 or more plug-in modules on one side

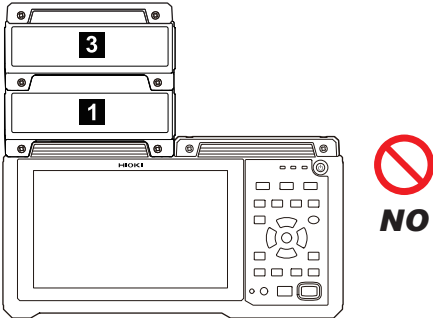

When connecting 5 or more plug-in modules

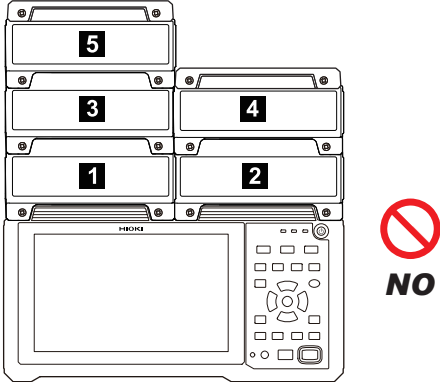

IMPORTANT
Plug-in modules ship with two spare screws (M3×35 mm). Exercise care not to lose them.

2.2 Installing a Battery Pack

You can power the instrument and wireless modules using the optional Z1007 Battery Pack when commercial power is not available.

You can also use the Battery Pack as a backup power supply in the event of a power outage while using commercial power.

DANGER

- Do not attempt to disassemble or modify the Battery Pack.
- Do not incinerate or heat the Battery Pack.
- Do not use the Battery Pack in locations where the temperature is higher than 80°C or leave it in a hot place.
- Do not soak the Battery Pack in liquid or get the Battery Pack wet.
- Do not puncture the Battery Pack with nails, strike it with a hammer, or step on it.
- Do not subject the Battery Pack to mechanical shock or throw the Battery Pack.
- Do not solder a wire or other conductor directly to the Battery Pack.
- Do not connect the Battery Pack to any device not specified by Hioki.
- Do not use any Battery Pack that exhibits exterior damage or whose shape has become deformed.
- Do not place the Battery Pack on top of an electromagnetic cooking device or inside a microwave oven or high-pressure container.
- If you notice that a Battery Pack being stored exhibits an anomaly (for example, unusual odor, heat, discoloration, or deformation in shape), do not use the Battery Pack.



Doing so may cause the Battery Pack to leak liquid, overheat, give off smoke, rupture, or ignite, resulting in serious bodily injury.

- Do not connect the Battery Pack's positive and negative terminals with a metallic object.

- Do not carry or store the Battery Pack together with metal instruments.

A short circuit of the terminals could cause the Battery Pack to leak liquid, overheat, give off smoke, rupture, or ignite, resulting in serious bodily injury. Alternatively, an excessive current could flow through the metal products, causing them to heat up. These hazards could result in serious bodily injury.

⚠ DANGER

- **To operate the instrument or a wireless module on battery power, use only the Z1007 Battery Pack.**

Use of other batteries may damage the instrument or cause the Battery Pack to leak liquid, overheat, give off smoke, rupture, or ignite, resulting in serious bodily injury. Hioki is not liable for any equipment damage or accident resulting from use of a battery pack other than the Z1007.



- **If you get electrolyte that has leaked from the Battery Pack in an eye, immediately wash the eye thoroughly with tap water or other clean water without rubbing and seek immediate medical attention.**

Failure to treat the eye may result in injury to the eye.

⚠ WARNING

- **If the Battery Pack malfunctions during charging, disconnect the AC Adapter from the instrument or measurement module to stop charging.**
- **If the Battery Pack fails to charge fully in the designated charge time, stop charging.**



- **If the Battery Pack malfunctions during use, stop using it immediately.**

Failure to do so may cause the Battery Pack to leak liquid, overheat, give off smoke, rupture, or ignite, resulting in bodily injury.

- **If the Battery Pack is leaking electrolyte or giving off an unusual odor, move it away from fire immediately.**

Failure to do so may cause the leaked electrolyte to ignite, causing bodily injury.

⚠ CAUTION

- **Do not use the Battery Pack in locations where it would be exposed to direct, strong sunlight or where it would become hot, for example inside a vehicle on a hot day.**
- **Do not leave the Battery Pack in hot locations.**
- **When using the Battery Pack for the first time after purchase, avoid use if you notice any rust, unusual odor, overheat, or other anomaly.**



Doing so may cause the Battery Pack to leak liquid, overheat, give off smoke, rupture, or ignite, resulting in bodily injury. It may also lower the Battery Pack's performance and reduce its service life.



- **If you get electrolyte leaked from the Battery Pack on your skin or clothing, immediately rinse with tap water or other clean water.**

Electrolyte may irritate the skin.

NOTICE

- **Be sure to use the included screws to close the cover.**

Use of screws that are longer than the included screws could damage the instrument.

IMPORTANT

- Be sure to charge Battery Packs when using them for the first time after purchase or for the first time after an extended period of non-use. Battery Pack capacity declines due to self-discharge.
- When operating time has become significantly shorter even though the Battery Pack was charged properly, the Battery Pack has reached its service life. Replace it with a new Battery Pack.
- Connect Battery Packs to the instrument or wireless module correctly.
- Charge Battery Packs within the ambient temperature range of 5°C to 35°C. Charging Battery Packs at a low temperature of close to 5°C will result in lower charge than at 23°C. The amount of time the instrument or wireless module can operate on the Battery Pack will decrease as the temperature falls.
- When not using a Battery Pack for an extended period of time, remove it from the instrument or wireless module and store it at about 20°C. Charge each Battery Pack for about 30 min. with the instrument or a wireless module once a year.
- Battery Packs are consumables. Each Battery Pack's service life (defined as the period of time during which its capacity is at least 70% of the initial capacity) is about 300 charge/discharge cycles. (Service life varies with storage method and operating environment.)
- For reasons related to Battery Pack characteristics, the indicated remaining battery life may diverge from the actual remaining battery life due to factors such as settings during use, operating temperature, and the number of battery charge/discharge cycles.

Installing the Battery Pack in the instrument

The instrument can accommodate two Z1007 Battery Packs.
One Battery Pack may be used alone.

You will need: Z1007 Battery Pack, a Phillip's head screwdriver (No. 2)

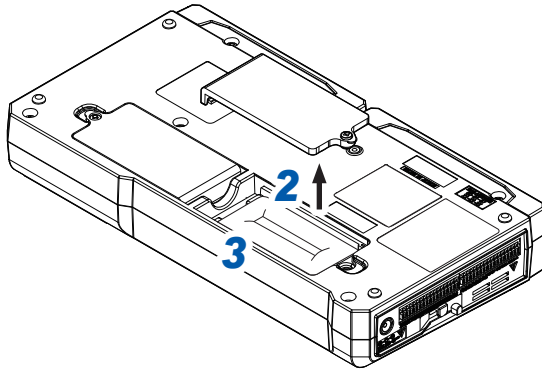

- 1** Turn off the instrument and disconnect the AC Adapter and cable.
- 2** Loosen the screw on the battery compartment on the rear of the instrument and remove the cover.
- 3** Insert the Battery Pack perpendicularly and slide it toward the pins until it pushes up against the pins.
- 4** Tighten the battery compartment screw securely.

Installing the Battery Pack in a wireless module

You will need: Z1007 Battery Pack, a Phillip's head screwdriver (No. 2)

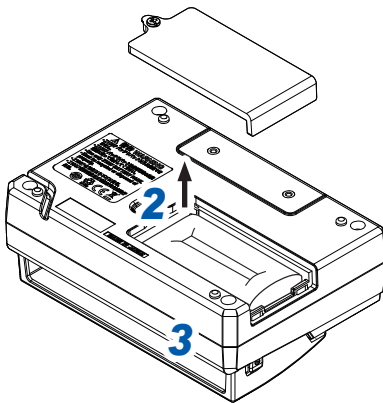

- 1** Turn off the instrument and disconnect the AC Adapter and cable.
- 2** Loosen the screw on the battery compartment on the rear of the wireless module and remove the cover.
- 3** Insert the Battery Pack perpendicularly and slide it toward the pins until it pushes up against the pins.
- 4** Tighten the battery compartment screw securely.

IMPORTANT

When using two Battery Packs, replace both at the same time. If you replace only one Battery Pack during use, the remaining battery life may not be detected correctly.

Charging the Battery Pack

You can charge the Battery Pack by connecting the Z1014 AC Adapter to the instrument or the Z1008 AC Adapter to the wireless module. The Battery Pack will continue to be charged even while the instrument or the wireless module is turned off. (p.46)

The **CHARGE** LED will turn orange while the Battery Pack is being charged. (On the instrument, the **CHARGE** LED will light up about 5 seconds after charging begins.)

Charging will stop once the Battery Pack is fully charged, and the **CHARGE** LED will turn off.

Rough charge time (LR8450/LR8450-01)

- About 7 hr. (when charging a Battery Pack with little remaining battery life)

Continuous operating time on Battery Pack power

Instrument

Approximate continuous operating time on one Battery Pack (reference value)

Approximate continuous operating time	Backlight brightness
About 2 hr.	5 (maximum brightness)

After being fully charged, with one U8551 Universal Unit connected, at an ambient temperature of 23°C

Enabling the backlight saver or lowering the backlight brightness (dimming the backlight) will increase the operating time.

See “Backlight saver” and “Backlight brightness” in the Instruction Manual.

When using two Battery Packs, the instrument will be able to operate continuously for about twice as long as on one Battery Pack.

The amount of time the instrument can operate on the Battery Pack will decrease as the temperature falls.

Even if the Battery Pack is fully charged, the instrument may not operate if the Battery Pack becomes cold. Attach two Battery Packs in the instrument, warm the Battery Pack to room temperature, or replace the Battery Pack with a standby Battery Pack.

Displaying the monitor and individual settings screens use battery power even if you have not yet started measurement because those screens collect data.

Charging time

Instrument

The battery icon on the screen will turn red when the battery life declines while the instrument is being powered by a Battery Pack. If this mark is displayed, connect the Z1014 AC Adapter and charge the battery.

Approximate time from when the instrument’s battery icon turns red until the battery has no remaining charge (reference value)

- About 10 min. (with four plug-in modules connected while saving waveform data in real time to an SD Memory Card, backlight brightness of 5 (maximum brightness), backlight saver off, 23°C)

2.3 Connecting the AC Adapter

The instrument ships with the Z1014 AC Adapter, while wireless modules ship with the Z1008 AC Adapter. Connect the power cord to the AC adapter and plug it into a power outlet.

Be sure to use the included AC Adapter (with a grounded two-prong power cord).

The optional Z1007 Battery Pack can be used to enable the instrument to continue operating in the event of a power outage. When using the AC Adapter with a Battery Pack, the AC Adapter has priority in powering the instrument. When power from the AC Adapter is interrupted, the instrument or module will switch to battery power.

Be sure to read "Handling of cords and cables" (p.47) before connecting the AC Adapter. In addition, turn off the instrument before connecting or disconnecting the AC Adapter.

2

Making Connections (Preparing for Measurement)

WARNING

- Use the included Z1014 AC Adapter (with a grounded 2-prong power cord) to operate the instrument on commercial power.
- Use the included Z1008 AC Adapter (with a grounded 2-prong power cord) to operate wireless modules on commercial power.
- Use the AC Adapter at the rated supply voltage and rated power supply frequency.



Rated supply voltage: 100 to 240 V AC (with voltage fluctuations within $\pm 10\%$)
Rated power supply frequency: 50/60 Hz

- Turn off the instrument and any wireless modules before connecting the AC Adapter to the instrument or wireless module and to a power outlet.
- Connect the power cord that came with the AC Adapter to a grounded two-prong power outlet.

Failure to do so could cause electric shock.

NOTICE

- Before inserting the plug into the outlet, connect the AC Adapter's output plug to the instrument or wireless module.
- When connecting an external power supply, connect the output plug to the instrument or wireless module before activating the power supply.



Failure to do so could damage the instrument.

- When unplugging the power cord from the outlet or the instrument, pull on the plug (not the cord).

Failure to do so could cause a wire break in the power cord.

Supplying power to the instrument with the AC Adapter (AC power)

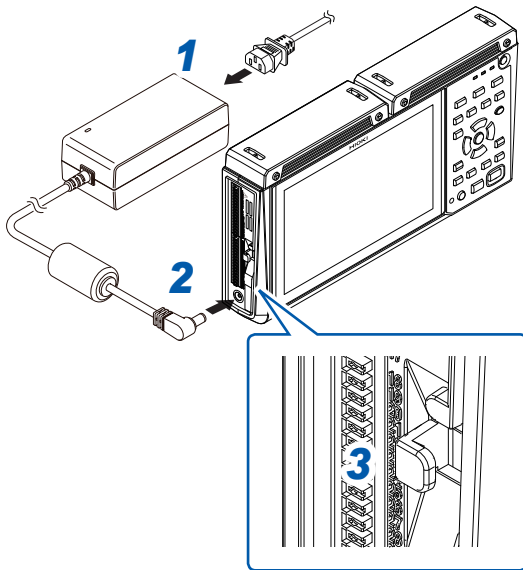

- 1** Connect the power cord to the Z1014 AC Adapter.
- 2** Connect the AC Adapter's output plug to the instrument.
- 3** To keep the plug from being pulled out inadvertently, insert the AC Adapter's output cord into the cable hook on the instrument.
- 4** Insert the plug on the power cord into an outlet.

Supplying power to a wireless module with the AC Adapter (AC power)

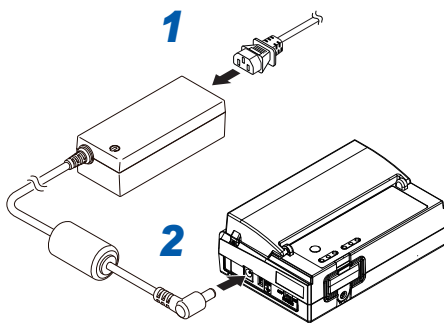

- 1** Connect the power cord to the Z1008 AC Adapter.
- 2** Connect the AC Adapter's output plug to the wireless module.
- 3** To keep the plug from being pulled out inadvertently, insert the AC Adapter's output cord into the cable hook on the bottom of the wireless module.
- 4** Insert the plug on the power cord into an outlet.

2.4 Connecting the Cables

Pre-use inspection

Inspect the instrument and wireless module before turning them on to check for damage during storage or shipping.

If you find any damage, contact your authorized Hioki distributor or reseller.

Inspection of peripheral equipment

Do the measurement cables you're about to connect have tears in their insulation, or is any metal exposed?

If you find any damage, do not use the measurement cable. Doing so could cause electric shock.

Replace the cable with the designated type.

Inspection of the instrument

- Does the instrument exhibit any damage?
If you find any damage, have the instrument repaired.
- When you turn on the instrument, does the screen work?
If no screen is displayed, there may be a wiring break in the power cord, or the instrument may be damaged. Have it repaired.

Handling of cords and cables

WARNING

■ Ensure measurement cables hang lower than the instrument.

Failure to do so could allow water or other liquids to travel down the measurement cables into the instrument, resulting in damage or bodily injury.

■ Before connecting measurement cables to measurement terminals or turning on the instrument, follow the procedure below:

1. Shut off the power to the measurement lines.
2. Turn off all equipment.
3. Remove the measurement cables from measurement targets.
4. Close the covers of the analog input terminals.



■ Use specified wiring only. Alternatively, use wiring that provides sufficient dielectric strength and current capacity.

Failure to do so may result in electric shock or a short-circuit.

■ Surely connect measurement cables to the input terminals.

A loosened screw could cause contact resistance to increase and thus the instrument to overheat, resulting in bodily injury, burning of the instrument, or fire.

CAUTION



■ Do not step on cords or allow them to become caught between other objects.

Doing so may damage insulation, resulting in bodily injury.

NOTICE

- **Do not apply a voltage exceeding the specifications between channels.**



Modules whose channels are isolated from one another incorporate semiconductor relays. Subjecting these modules to a voltage exceeding the voltage specified in the instrument's specifications could cause a short circuit fault of the semiconductor relays.

IMPORTANT

- Measurement may be affected by the EMC environment, for example external noise, when connecting cables of greater than 3 m in length. Keep cables away from power lines and ground lines.
- Measured values may exhibit variability when cables are connected in parallel with other devices. Be sure to verify proper operation when connecting cables in parallel.

When connecting cords to the analog input terminals

⚠ DANGER



- **Do not leave input cords connected in environments where there is the possibility of a surge exceeding the dielectric strength.**

Doing so may damage the instrument, resulting in serious bodily injury.

⚠ WARNING

- **Before connecting measurement cables to the analog input terminals, follow the procedure below:**



1. Turn off the instrument and all equipment to be connected.
2. Eliminate static electricity from the body.

Failure to do so could cause electric shock or damage to the instrument.

When using wires with crimp terminals, use insulated terminals designed for use with M3 screws in the following sizes:



6 mm or less



6 mm or less

When connecting cables to the external control terminals

WARNING

- **Before connecting cables to the external control terminals, follow the procedure below:**



1. Turn off the instrument and all equipment to be connected.
2. Eliminate static electricity from the body.
3. Make sure that the signals do not exceed the rating of the external input/output.
4. Appropriately isolate the equipment to be connected

Failure to do so could cause electric shock or damage to the instrument.

NOTICE



- **Do not short-circuit the output terminal or input a voltage to the output terminal.**

Failure to do so could damage to the instrument.

- **Take appropriate measures so that the ground of the external control terminal and that of targets to be connected have the same potential.**



Failure to do so could cause damage to the targets to be connected and the instrument.

The external control terminals share the ground with the instrument: the grounds of them are not insulated from one another.

When using twisted-pair wiring for measurement cables, exercise care not to make contact with adjacent measurement cables or terminals.

Connecting voltage cables and thermocouples

Connecting wires to a screw-type terminal block

⚠ WARNING



- For screw-type terminal blocks, use specially designed screws to secure connections.

Use of other screws could result in electric shock or equipment damage.

Applicable modules: U8550, U8553, LR8530, LR8533

You will need: A Phillip's head screwdriver (No. 2) and an input cable or thermocouple

Recommended wire diameter

Single-wire	Diameter of 0.2 mm to 1.29 mm (AWG 32 to 16)
Stranded wire	0.03 mm ² to 1.38 mm ² (AWG 32 to 16)
Standard stripping length	10 mm

- 1** Open the terminal block cover.
- 2** Loosen the terminal block screw. Insert the tip of the cable as shown in the figure and tighten the screw.

Tighten the terminal block screws to 0.8 N·m or less (0.4 N·m recommended).

Cable insulation colors vary by country and manufacturer. Check before connecting.



- 3** Connect the cable to the measurement target.
- 4** Close the terminal block cover.

When measuring an instrumentation device (inputting a 4-20 mA current), connect a 250 Ω shunt resistor as shown in the figure.

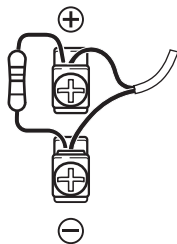

For more information about measuring instrumentation devices, see "Measuring voltage" in the Instruction Manual.

Connecting wires to a push-button terminal block

Applicable modules: U8551, U8552, U8554, LR8531, LR8532, LR8534

You will need: A flat-head screwdriver (with a tip width of 2.6 mm) and an input cable or thermocouple

Recommended wire diameter

Single-wire	Diameter of 0.32 mm to 1.29 mm (AWG 26 to 16)
Stranded wire	0.2 mm ² to 0.52 mm ² (AWG 24 to 20)
Standard stripping length	9 mm

- 1** Open the terminal block cover.
- 2** Press down on the terminal button with the flat-head screwdriver.

Cable insulation colors vary by country and manufacturer. Check before connecting. For more information about Strain Unit input terminals, see “(5) Voltage input” (p.58).

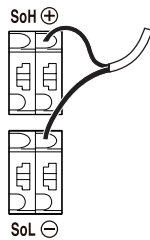

- 3** Remove the flat-head screwdriver from the button.
The cable will be locked in place. Pull gently on the cable and verify that it does not come out.
- 4** Connect the cable to the measurement target.
- 5** Close the terminal block cover.

Connecting resistance bulbs

Applicable modules: U8551, LR8531

You will need: A flat-head screwdriver (with a tip width of 2.6 mm) and a resistance bulb

Recommended wire diameter

Single-wire	Diameter of 0.32 mm to 1.29 mm (AWG 26 to 16)
Stranded wire	0.2 mm ² to 0.52 mm ² (AWG 24 to 20)
Standard stripping length	9 mm

- 1** Open the terminal block cover.
- 2** Press down on the terminal button with the flat-head screwdriver.
- 3** Insert the cable into the terminal hole while depressing the button.

Three-wire type: Insert the cables into the positive terminal (red), negative terminal (black), and SoL terminal (black).

Four-wire type: Insert the cables into the positive terminal (red), negative terminal (black), SoL terminal (black), and SoH terminal (red).

3-wire setup

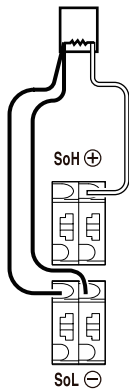

4-wire setup

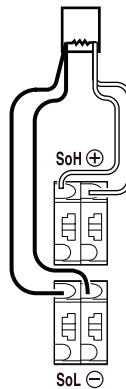

Cable insulation colors vary by country and manufacturer. Check before connecting.

- 4** Remove the flat-head screwdriver from the button.
The cable will be locked in place. Pull gently on the cable and verify that it does not come out.
- 5** Connect the cable to the measurement target.
- 6** Close the terminal block cover.

Connecting the Humidity Sensor

Applicable modules: U8550, U8551, U8552, LR8531

You will need: A flat-head screwdriver (with a tip width of 2.6 mm) and the Z2000 Humidity Sensor

- 1** Open the terminal block cover.
- 2** Connect the Z2000 Humidity Sensor's power cable to external control terminal voltage output terminal 1 or 2.

Connect the red cable to the "VOUTPUT1" terminal or the "VOUTPUT2" terminal and the black cable to the "GND" terminal.

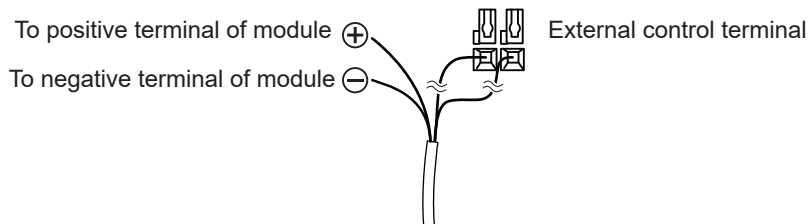

With the LR8531, you can connect the Humidity Sensor's power cable to the module's Z2000 Humidity Sensor power supply terminal.

Connect the red cable to the positive terminal and the black cable to the negative terminal.

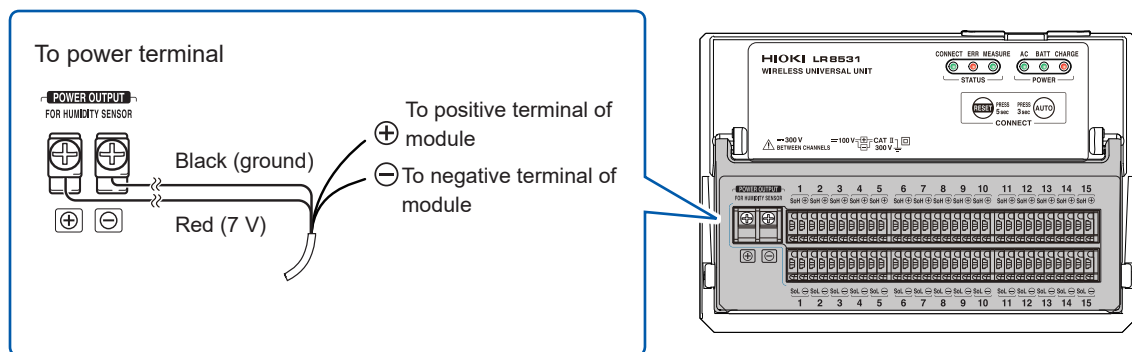

- 3** Connect the Z2000's measurement cable to the input channel's push-button terminal or screw terminal.

Connect the yellow cable to the positive terminal and the green cable to the negative terminal.

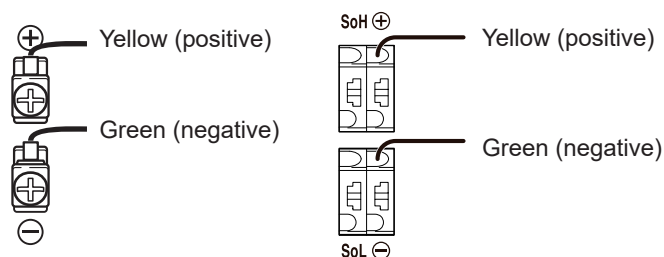

- 4** Pull gently on the cable and verify that it does not come out.
- 5** Affix the Z2000 to the measurement target.
- 6** Close the terminal block cover.

If supplying power to a Z2000 Humidity Sensor from the external control terminal voltage output terminal 1 or 2, choose the [12 V] setting.

See "8.1 Configuring Voltage Output (VOUTPUT)" in the Instruction Manual

NOTICE



■ **Do not use the Z2000 Humidity Sensor in locations with an excessive amount of dust or locations causing the instrument to get wet.**

Doing so could damage the Z2000 Humidity Sensor, which is not water-resistant or dust-resistant.

- The Z2000 Humidity Sensor's sensitivity and precision will degrade over time, even under normal operating conditions. To ensure measurement within the accuracy specifications, it is recommended to replace the sensor with a new model after one year of the first open of the sealed package.
- If the conditions diverge from the indicated operating (storage) environment, the Z2000 Humidity Sensor's precision may degrade in less than a year, making it incapable of accurate measurement.
- In principle, placing the Z2000 Humidity Sensor in an environment where it would be exposed to organic gases (ketone, acetone, ethanol, toluene, etc.) may cause the sensor surface to become contaminated, increasing humidity measurement error.
- Ensure that the Z2000 Humidity Sensor is not exposed to high concentrations of chemical solvents for extended periods of time during use or storage.
- The sensor may also be contaminated by organic gases released by vinyl chloride or packaging materials.
- When not using the Z2000 Humidity Sensor, seal it along with a package of desiccant in the polyethylene bag in which it was shipped and store it in a cool, dark place.
- Exercise care to avoid condensation. The sensor is particularly prone to condensation in environments where the temperature changes rapidly.
- Proper operation is not guaranteed in the event that conditions diverge from the indicated operating (storage) environment.
- Changes in humidity (to high humidity from low humidity or to low humidity from high humidity) will affect measured values due to hysteresis. The Z2000 Humidity Sensor's measured values are affected within a range of about 3% RH.

Connecting a resistor

Applicable modules: U8551, LR8531

You will need: A flat-head screwdriver (with a tip width of 2.6 mm) and an input cable (for resistance measurement)

Recommended wire diameter

Single-wire	Diameter of 0.32 mm to 1.29 mm (AWG 26 to 16)
Stranded wire	0.2 mm ² to 0.52 mm ² (AWG 24 to 20)
Standard stripping length	9 mm

- 1** Open the terminal block cover.
- 2** Press down on the terminal button with the flat-head screwdriver.
- 3** Insert the cable into the terminal hole while depressing the button.

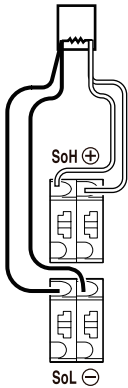

Connect the resistor using a 4-wire setup (the instrument cannot measure 2- or 3-wire setups).

One side of the resistor: Insert the wires into the positive terminal (red) and the SoH terminal (red).

Other side of the resistor: Insert the wires into the negative terminal (black) and the SoL terminal (black).

- 4** Remove the flat-head screwdriver from the button.
The cable will be locked in place. Pull gently on the cable and verify that it does not come out.
- 5** Close the terminal block cover.

Connecting a strain gage or strain gage-type converter

Applicable modules: U8554, LR8534

You will need: A flat-head screwdriver (with a tip width of 2.6 mm) and a strain gage or a strain gage-type converter

Recommended wire diameter

Single-wire	Diameter of 0.32 mm to 1.29 mm (AWG 26 to 16)
Stranded wire	0.2 mm ² to 0.52 mm ² (AWG 24 to 20)
Standard stripping length	9 mm

- Choose a strain gage whose gage resistance value is 120 Ω. If you plan to use a 350 Ω strain gage, add a separate bridge box and use the same connection as for the 4-gage method (converter).
- Choose a strain gage-type converter that supports a bridge voltage of 2 V DC.

NOTICE



- Do not bend, pull on, or twist cables, including where they connect, excessively. Doing so could cause a wire break into the cable.

- Keep the cables away from power lines and ground lines.
- When measuring with a voltage range of 5 mV or less, measurement may be affected by the thermal electromotive force of wires and connectors.
- Perform auto-balancing using the same wires and connectors as will be used in measurement.
- All channels in the U8554 and LR8534 terminal block have a common E terminal (GND).
- If connecting the lead wires for the strain gage or other sensor directly, strip back about 9 mm of insulation from the tip of each lead wire first.
- When using a strain gage, connect lead wires of the recommended wire diameter using the gage terminals or use a strain gage with lead wires of the recommended wire diameter.
- If the sensor has a connector (NDIS connector, etc.) like a strain gage-type converter, use the connection cable supplied by the sensor manufacturer to connect it.

Affixing connection confirmation labels

Affix the included connection confirmation labels as desired (for example, on the back of the terminal block cover).

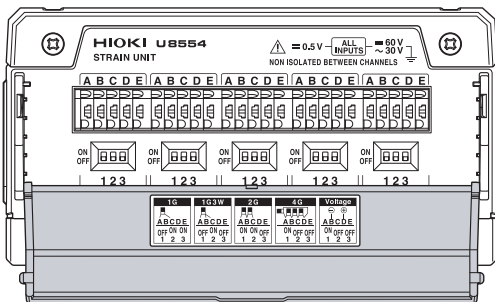

If label is affixed to the terminal block cover

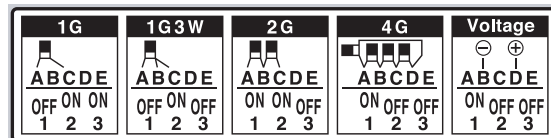

Connection confirmation label

- 1** Open the terminal block cover.
- 2** Set the DIP switch depending on the connection method.
To set the DIP switch, see “Setting the DIP switches for input connections” (p.58)
- 3** Press down on the terminal button with the flat-head screwdriver.
- 4** Insert the cable into the terminal hole while depressing the button.
To find target terminals to which cables are connected, see “Setting the DIP switches for input connections” (p.58)

Example: 1-gage method (2-wire setup)

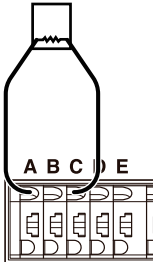

- 5** Remove the flat-head screwdriver from the button.
The cable will be locked in place. Pull gently on the cable and verify that it does not come out.
- 6** Close the terminal block cover.



How to display the strain gage connection guide

- ▶ Press the **QUICK SET** key, and choose [**Strain gauge connection guide**]. The strain gauge connection diagrams will be displayed.
See “1.13 Configuration Navigator (Quick Set)” in the Instruction Manual.



Setting the DIP switches for input connections

This section describes how to set the DIP switches for input connections. The dip switch is on in the upper position and off in the lower position.

(1) 1-gage method (2-wire setup)

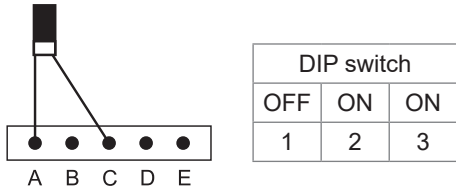

(2) 1-gage method (3-wire setup)

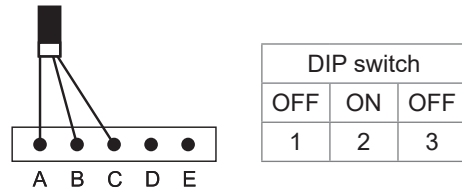

(3) 2-gage method (adjacent sides)

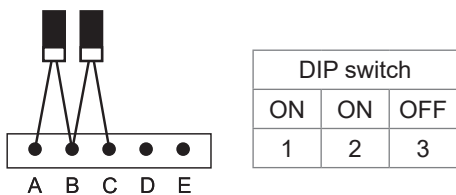

(4) 4-gage method/converter

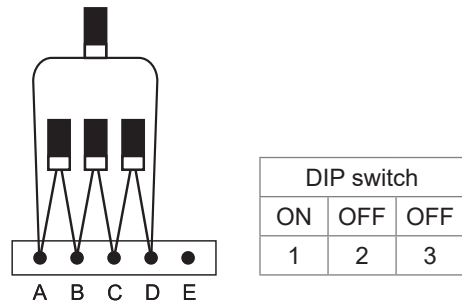

(5) Voltage input

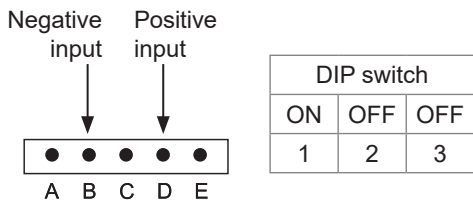

When connecting a converter, the terminals function as indicated below. If the converter output utilizes a connector (such as NDIS connector), use a cable with a connector on one end and loose wires on the other to make the connection.

- A Applied voltage (+)
- B Converter output (-)
- C Applied voltage (-)
- D Converter output (+)
- E Measurement GND

Tips

- After installing the strain gage and completing its wiring, perform auto-balancing before measurement. See "Measuring strain" in the Instruction Manual.
- Secure the strain gage wires in place and ensure that the gage itself is not subjected to force.

Connecting pulse input

This section describes how to connect pulse input to the instrument's external control terminals.

You will need: A flat-head screwdriver (with a tip width of 2.6 mm) and an input cable (for pulse measurement)

Recommended wire diameter

Single-wire	Diameter of 0.32 mm to 0.81 mm (AWG 28 to 20)
Stranded wire	0.08 mm ² to 0.32 mm ² (AWG 28 to 20)
Standard stripping length	10 mm

- 1** Position the instrument so that the external control terminals on its side are facing you.
- 2** Press down on the button for pulse 1 (or pulse 2 through 8) terminal with the flat-head screwdriver.
- 3** Insert the positive (+) cable into the terminal hole while depressing the button.
- 4** Remove the flat-head screwdriver from the button.
The cable will be locked in place. Pull gently on the cable and verify that it does not come out.
- 5** Press down on the GND terminal button with the flat-head screwdriver.
There are 10 GND terminals. The wire can be connected to any of the GND terminals.
- 6** Insert the negative (-) cable into the terminal hole while depressing the button.
- 7** Remove the flat-head screwdriver from the button.
The cable will be locked in place. Pull gently on the cable and verify that it does not come out.

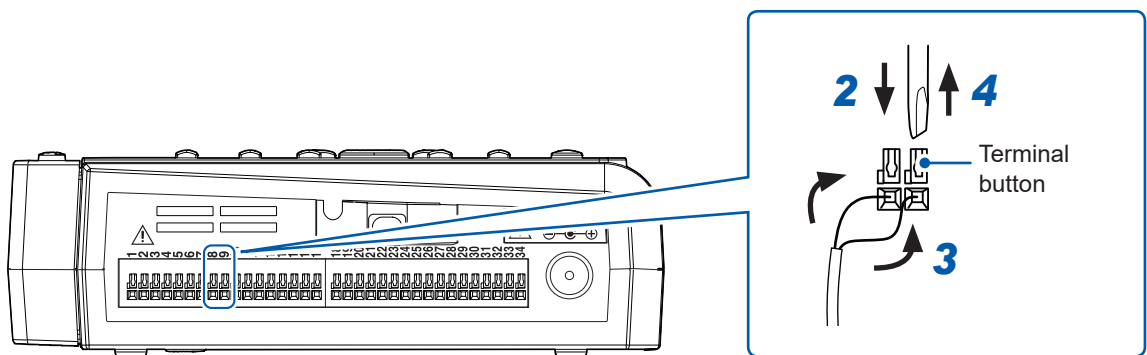

Example connecting to pulse 4 and GND



How to check the pin assignments of the external control terminals

Press the **QUICK SET** key, and choose **[External connection guide]**. Names of the external control terminals will be displayed.

Connecting alarm output

This section describes how to connect alarm output to the instrument's external control terminals. You will need: A flat-head screwdriver (with a tip width of 2.6 mm) and an output cable (alarm output)

Recommended wire diameter

Single-wire	Diameter of 0.32 mm to 0.81 mm (AWG 28 to 20)
Standard wire	0.08 mm ² to 0.32 mm ² (AWG 28 to 20)
Standard stripping length	10 mm

- 1** Position the instrument so that the external control terminals on its side are facing you.
- 2** Press down on the button for alarm output 1 (or alarm output 2 through 8) terminal with the flat-head screwdriver.
- 3** Insert the cable into the terminal hole while depressing the button.
- 4** Remove the flat-head screwdriver from the button.
The cable will be locked in place. Pull gently on the cable and verify that it does not come out.
- 5** Press down on the GND terminal button with the flat-head screwdriver.
There are 10 GND terminals. The wire can be connected to any of the GND terminals.
- 6** Insert the cable into the terminal hole while depressing the button.
- 7** Remove the flat-head screwdriver from the button.
The cable will be locked in place. Pull gently on the cable and verify that it does not come out.

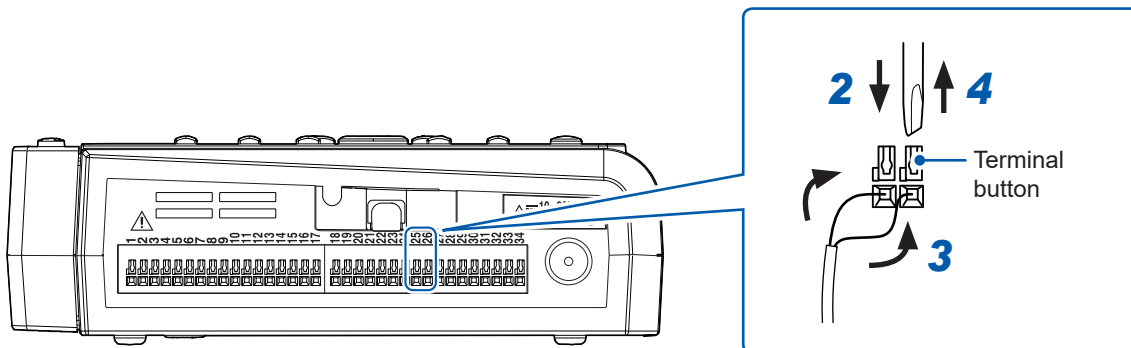

Example connecting to alarm output 4 and GND



How to check the pin assignments of the external control terminals

Press the **QUICK SET** key, and choose **[External connection guide]**. Names of the external control terminals will be displayed.

Connecting voltage output

This section describes how to connect voltage output to the instrument's external control terminals. The instrument can output a DC voltage for driving sensors.

You can choose the output voltage. The maximum supplied current is 100 mA.

- Voltage output terminal 1: 5 V, 12 V, 24 V
- Voltage output terminal 2: 5 V, 12 V

For more information about voltage output settings, see “8.1 Configuring Voltage Output (VOUTPUT)” in the Instruction Manual.

You will need: A flat-head screwdriver (with a tip width of 2.6 mm) and an output cable (5 V to 24 V DC)

Recommended wire diameter

Single-wire	Diameter of 0.32 mm to 0.81 mm (AWG 28 to 20)
Standard wire	0.08 mm ² to 0.32 mm ² (AWG 28 to 20)
Standard stripping length	10 mm

NOTICE

- **Do not short the voltage output terminals and GND terminals.**



Once the output voltage has been set for the voltage output terminal, that voltage will be output as long as the instrument is turned on. Shorting the terminals in this state could damage the instrument.

- **Do not apply a voltage from an external source to the voltage output terminals.**

Doing so could damage the instrument.



- **Connect cables to voltage output terminals before turning on output.**

Connecting cables to voltage output terminals while voltage is being output could damage the instrument.

- 1** Position the instrument so that the external control terminals on its side are facing you.
- 2** Press down on the button for the voltage output terminal 1 or voltage output terminal 2 with the flat-head screwdriver.
- 3** Insert the positive (+) cable into the terminal hole while depressing the button.
- 4** Remove the flat-head screwdriver from the button.
The cable will be locked in place. Pull gently on the cable and verify that it does not come out.
- 5** Press down on the GND terminal button with the flat-head screwdriver.
There are 10 GND terminals. The wire can be connected to any of the GND terminals.
- 6** Insert the negative (-) cable into the terminal hole while depressing the button.
- 7** Remove the flat-head screwdriver from the button.
The cable will be locked in place. Pull gently on the cable and verify that it does not come out.

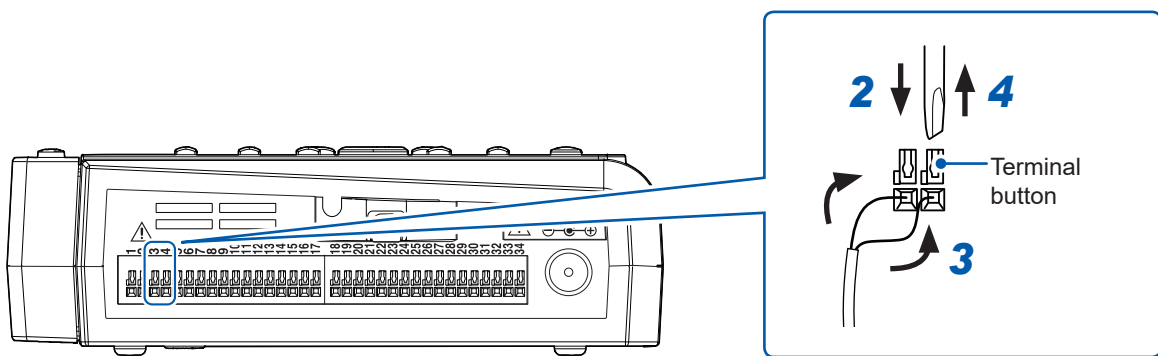

Example connecting to voltage output 2 and GND

Tips

How to check the pin assignments of the external control terminals

Press the **QUICK SET** key, and choose **[External connection guide]**. Names of the external control terminals will be displayed.

Connecting external control signals

This section describes how to connect external control signals to the instrument's external control terminals. You can choose functions using external I/O.

External input: You can control when to start and stop the instrument and input trigger signals. See "8.3 Configuring External Input/Output (I/O) Terminals" in the Instruction Manual.

External output: You can output signals when a trigger is activated. See "Trigger output" in the Instruction Manual.

You will need: A flat-head screwdriver (with a tip width of 2.6 mm) and an input cable (for pulse measurement)

Recommended wire diameter

Single-wire	Diameter of 0.32 mm to 0.81 mm (AWG 28 to 20)
Standard wire	0.08 mm ² to 0.32 mm ² (AWG 28 to 20)
Standard stripping length	10 mm

- 1** Position the instrument so that the external control terminals on its side are facing you.
 - 2** Press down on the terminal button with the flat-head screwdriver.
 - 3** Insert the cable into the terminal hole while depressing the button.
 - 4** Remove the flat-head screwdriver from the button.
- The cable will be locked in place. Pull gently on the cable and verify that it does not come out.
- 5** Press down on the GND terminal button with the flat-head screwdriver.
- There are 10 GND terminals. The wire can be connected to any of the GND terminals.
- 6** Insert the cable into the terminal hole while depressing the button.
 - 7** Remove the flat-head screwdriver from the button.

The cable will be locked in place. Pull gently on the cable and verify that it does not come out.

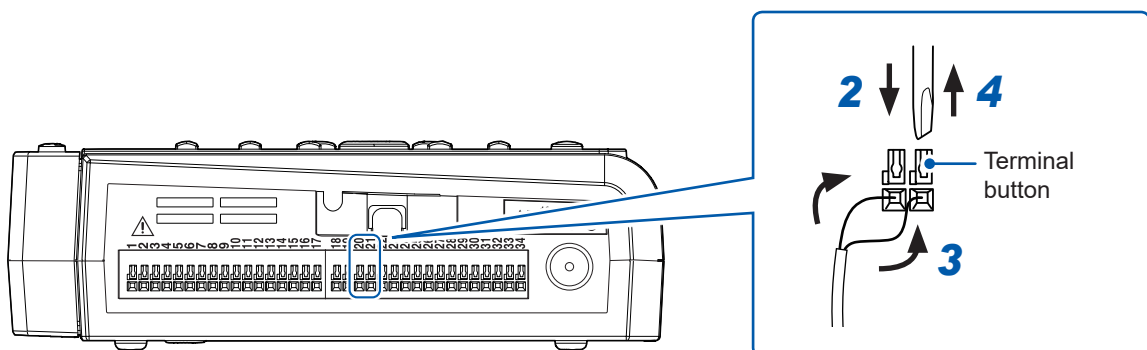

Example connecting to external input 2 and GND



How to check the pin assignments of the external control terminals

Press the **QUICK SET** key, and choose **[External connection guide]**. Names of the external control terminals will be displayed.

2.5 Turning the Instrument On and Off

⚠ WARNING



- Before turning on the instrument, verify that the supply voltage you plan to use falls within the supply voltage range noted on the instrument's AC Adapter.

Supplying a voltage that falls outside the specified range to the AC Adapter could damage the instrument or AC Adapter, causing bodily injury.

NOTICE



- Do not input a voltage or current to input terminals while the instrument or wireless module is off.

Doing so could damage the instrument or wireless module.

IMPORTANT

- Be sure to turn off the instrument and any wireless modules after use.
- The instrument and wireless modules will not malfunction in the event of a momentary power interruption lasting 40 ms or less. However, an interruption lasting longer than 40 ms will cause the instrument and wireless modules to malfunction. Check the condition of the power supply being used. In addition, you can continue measurement even in the event of an outage by using the Z1007 Battery Pack. See "2.2 Installing a Battery Pack" (p.40).

LR8450/LR8450-01

(1) Turning on the instrument

Press the power key to turn on the instrument. The **POWER** LED will turn green.

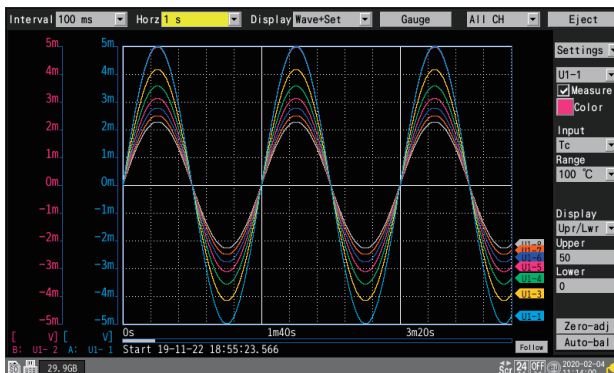
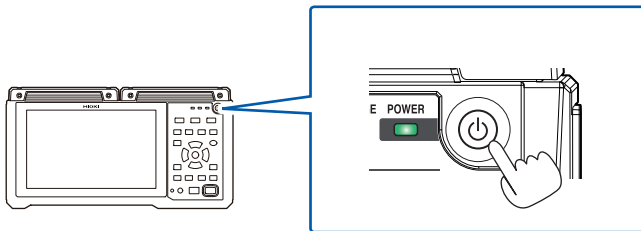

When the instrument starts up, the power icon will be shown on the bottom right of the screen.

When the instrument is powered by the AC Adapter, the power plug mark will be displayed.

When operating on battery power, the remaining battery life will be displayed.

(2) Turning off the instrument

Pressing the power key while the instrument is on will cause the instrument to display a message confirming whether you want to turn off the instrument. Choose **[OK]** and press the **ENTER** key to turn off the instrument.

2.6 SD Memory Card and USB Drive

You can save the instrument's measurement data and settings to an SD Memory Card or USB Drive.

You can also load previously saved data into the instrument to reproduce it.

Use only the following Hioki options, which are more reliable than their commercial equivalents.

Z4001 SD Memory Card (2 GB), Z4003 SD Memory Card (8 GB), Z4006 USB Drive (16 GB)

See "3 Saving and Loading Data" in the Instruction Manual.

WARNING



- **Do not attempt to modify, disassemble, or repair an SD Memory Card or USB Drive yourself.**

Doing so may result in bodily injury or fire.



- **Store SD Memory Cards and USB Drives out of reach of young children.**

Failure to do so could allow young children to accidentally ingest the SD Memory Card or USB Drive.

CAUTION



- **Do not apply labels or other stickers to SD Memory Cards.**

- **Do not use the SD Memory Card or USB Drive if there are water droplets on its terminal.**

Doing so may cause the SD Memory Card to become hot, resulting in burns or fire.

NOTICE



- **Do not bend or drop SD Memory Cards or USB Drives, or subject them to strong mechanical shocks.**

- **Do not transport the instrument while connected to a USB Drive.**

- **Do not forcibly insert an SD Memory Card or USB Drive upside down or in the wrong orientation.**

Doing so could damage the SD Memory Card, USB Drive, or instrument.

- **Never eject the SD Memory Card or USB Drive while the instrument is performing measurement or accessing the SD Memory Card or the USB Drive (while the LED next to the **SAVE** key lights up).**

Doing so could corrupt the data on the SD Memory Card or USB Drive.



- **Take steps to ensure that static electricity is not applied to SD Memory Cards or USB Drives.**

Application of static electricity could damage the SD Memory Card or USB Drive, or cause the instrument to malfunction.

- **Eject the USB Drive from the instrument before turning on the instrument.**

The instrument may fail to start up if it is turned on while a USB Drive is inserted. If you encounter this issue, insert the USB Drive after first turning on the instrument. In addition, it is recommended to use USB Drives only after verifying proper operation.

- **Use USB Drives within the specified temperature and humidity ranges.**

Failure to do so could damage the USB Drive.

IMPORTANT

- SD Memory Cards and USB Drives have a service life because they use flash memory. They lose the ability to store and load data after extended use. If you encounter this issue, purchase a new card or drive.
- Hioki is not liable for data stored on SD Memory Cards and USB Drives, regardless of the nature or cause of the accident or damage involved. Data saved on SD Memory Cards and USB Drives may become unreadable after an extended period of time has passed. Be sure to back up any important data on SD Memory Cards and USB Drives.
- Format new SD Memory Cards and USB Drives with the instrument prior to use. Using those formatted with a computer could prevent the real-time saving from keeping up with the measurement.
- Verify that the write protect switch has been disengaged before inserting an SD Memory Card into the instrument.
- Proper operation of the instrument is only guaranteed when using Hioki optional SD Memory Cards and USB Drives. Proper operation is not guaranteed with other recording media.
- Observe the following to avoid loss or corruption of internally stored data:
 1. Do not touch terminals or connection surfaces with your fingers or metallic objects.
 2. Do not subject the instrument to vibration or mechanical shock or turn it off while writing or reading data.
 3. Verify that SD Memory Cards and USB Drives do not contain important information (files) before initializing them.
 4. Follow the procedure on the next page when removing the SD Memory Cards and USB Drives.

Inserting and removing SD Memory Cards

Inserting an SD Memory Card

- 1** Orient the SD Memory Card so that the ▲ mark is facing upward and insert it into the SD card slot.
- 2** Insert the card until it locks in place with a clicking sound.

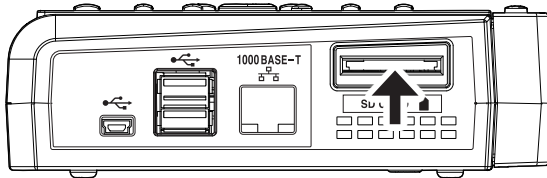

Removing an SD Memory Card

- 1** Check if measurement has stopped.
- 2** Press the **FILE** key to display the FILE screen.
- 3** Press the **Left Arrow** and **Right Arrow** keys to choose **[SD]**.
- 4** Press the **ENTER** key while **[Eject]** is selected.
The **[Eject media]** window will be displayed.
- 5** Press the **ENTER** key while **[OK]** is selected.
After the message **[SD card can be safely removed]** has been displayed, you can remove the SD Memory Card
- 6** Push in on the SD Memory Card. Once the card is sticking out slightly, grip it and pull it out.

Inserting and removing USB Drives

Inserting a USB Drive

- 1 Align the plug of the USB Drive with the USB port of the instrument.
- 2 Insert the USB Drive as far as it will go.

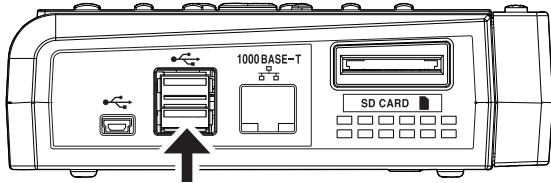

Removing a USB Drive

- 1 Verify that the instrument is not accessing the USB Drive (saving or writing data, etc.).
- 2 Press the **FILE** key to display the FILE screen.
- 3 Press the **Left Arrow** and **Right Arrow** keys to choose **[USB]**
- 4 Press the **ENTER** key while **[Eject]** is selected.
The **[Eject media]** window will be displayed.
- 5 Press the **ENTER** key while **[OK]** is selected.
After the message **[USB flash drive can be safely removed]** has been displayed, you can remove the SD Memory Card
- 6 Remove the USB Drive.



- You can replace an SD Memory Card or USB Drive while real-time saving is enabled. See "3.3 Saving Data" in the Instruction Manual.
- If an FTP client connects to the instrument, ejecting media will cause a failure. Close the FTP client connection before conducting the procedure for ejecting the media again.



This section provides basic instructions for how to operate the instrument.

For more detailed information about settings, see “1 Settings and Operation” in the Instruction Manual.

3.1 Configuration Process	p.70
3.2 Basic Operation	p.71
Switching among the main tabs	p.71
Switching among the sub tabs	p.71
Changing and accepting settings	p.72
Starting and stopping measurement	p.73
Saving data	p.73
Resetting the system (initialization).....	p.74
Key lock (disabling keys).....	p.74

3.1 Configuration Process

Before starting measurement, you must set measurement conditions such as recording interval and range.

You can save configured measurement conditions to media (an SD Memory Card or USB Drive). See “3 Saving and Loading Data” in the Instruction Manual.

You can perform measurement using the same settings as in the past by loading previously saved measurement conditions.

Settings are retained even when the instrument is turned off.

- 1 Set the recording conditions. See “1.2 Setting Measurement Conditions” in the Instruction Manual.

Press the **SET** key to display the **[Measure]** settings screen.

Set the recording interval, recording time, and other parameters on the **[Measure]** settings screen.

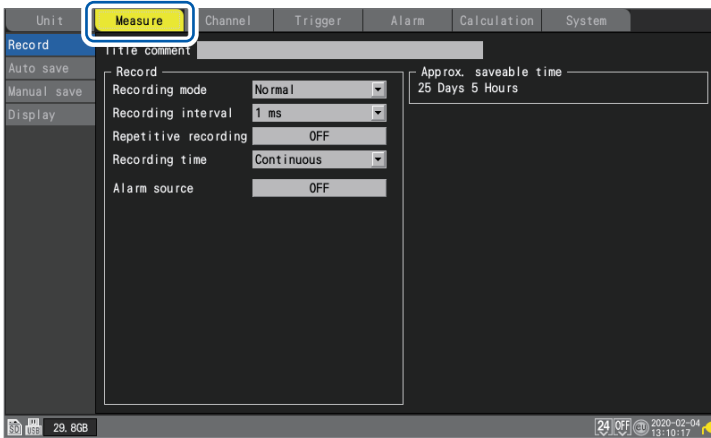

- 2 Configure the input channels. See “1.3 Configuring Input Channels” in the Instruction Manual.

Press the **SET** key to display the **[Channel]** settings screen.

Configure input channels for parameters such as voltage and temperature on the **[Channel]** settings screen.



3.2 Basic Operation

This section provides basic instructions for how to operate the instrument. You can configure settings by operating the instrument's keys. You can switch between main and sub tabs on the settings screens. See "1.1 Performing Basic Operations" in the Instruction Manual.

In this manual, the active item is said to have "focus." The background of the selected item will turn yellow.

Switching among the main tabs

Press the **SET** key to display the settings screen. You can switch among the following seven main tabs (listed at the top of the screen): **[Unit]**, **[Measure]**, **[Channel]**, **[Trigger]**, **[Alarm]**, **[Calculation]**, and **[System]**. You can switch among the main tabs using the **Left Arrow** and **Right Arrow** keys. You can move the focus among sub tabs by pressing the **ENTER** key. You can return the focus to the main tab by pressing the **ESC** key. You can also switch among the main tabs using the **SET** key.



Switching among the sub tabs

After selecting a main tab, you can switch the screen's contents further with sub tabs (shown on the left side of the screen). Select the sub tab whose settings you wish to configure with the **Up Arrow** and **Down Arrow** keys. You can move the focus to the settings area by pressing the **ENTER** key. You can return the focus to the sub tab by pressing the **ESC** key.

For example, once you have selected the **[Measure]** main tab, you can switch the screen's contents among the following five sub tabs: **[Record]**, **[Auto save]**, **[Manual save]**, and **[Display]**.

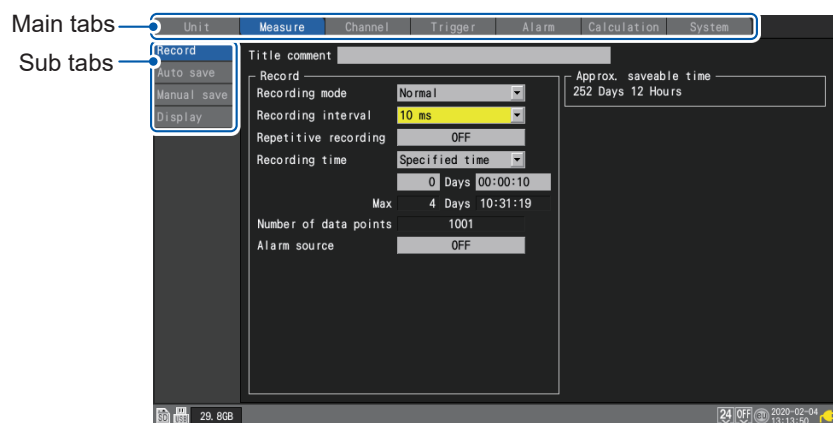
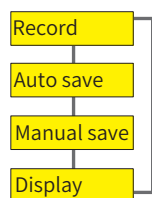

Changing and accepting settings

- 1 Select the setting you wish to configure with the **Left Arrow**, **Right Arrow**, **Up Arrow**, and **Down Arrow** keys.

You can now configure the setting with focus (shown in yellow).

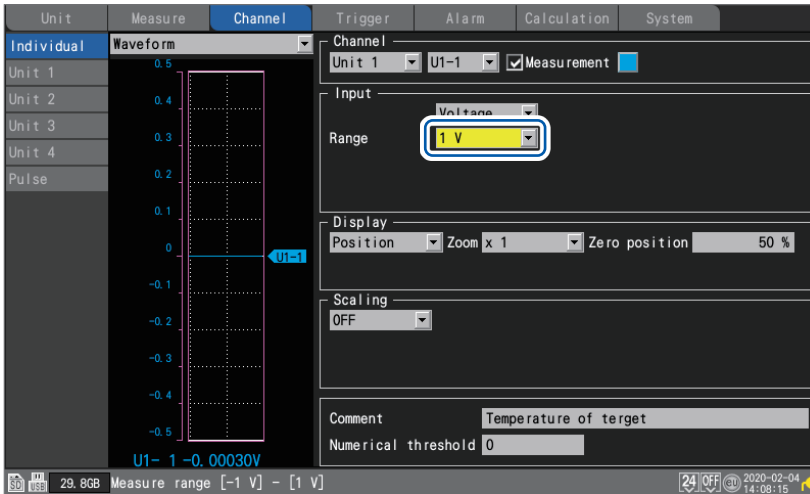

- 2 Press the **ENTER** key.

The available settings will be displayed.

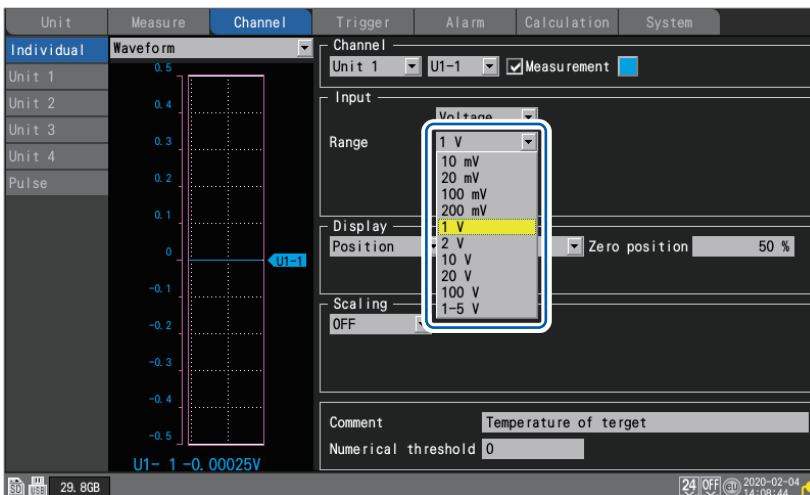

- 3 Select the desired setting with the **Up Arrow** and **Down Arrow** keys and then press the **ENTER** key.

The setting will be accepted.

You can also change the channel being configured with the following keys:

- **UNIT/SHEET** keys: Changes the measurement module number.
- **CHANNEL** keys: Changes the channel number.

Starting and stopping measurement



Press the **START** key to start measurement.

When the **[System] > [Environment] > [Operation error prevention]** setting is set to **[ON]**, operation confirmation window will be displayed. Select **[Yes]** and press the **ENTER** key to start measurement.

Starting measurement after stopping it will cause the measurement data in the instrument's internal buffer memory to be deleted. Save important data on an SD Memory Card or USB Drive before starting measurement again.



Press the **STOP** key to stop measurement.

When the **[System] > [Environment] > [Operation error prevention]** setting is set to **[ON]**, operation confirmation window will be displayed. Select **[Yes]** and press the **ENTER** key to stop measurement.



- Measurement can also be stopped automatically at the set recording time. See "1.2 Setting Measurement Conditions" in the Instruction Manual.
- You can prevent mistaken operation of the **START** and **STOP** keys. See "7.1 Configuring Settings" in the Instruction Manual.
- You can start recording operation when specific conditions occur. This functionality is convenient when you wish to monitor conditions for anomalies. See "2 Trigger Function" in the Instruction Manual.

Saving data

You can save measurement data, settings, screen images, numerical calculation results, and other information with to storage media.

SAVE



Press the **SAVE** key to display the window.

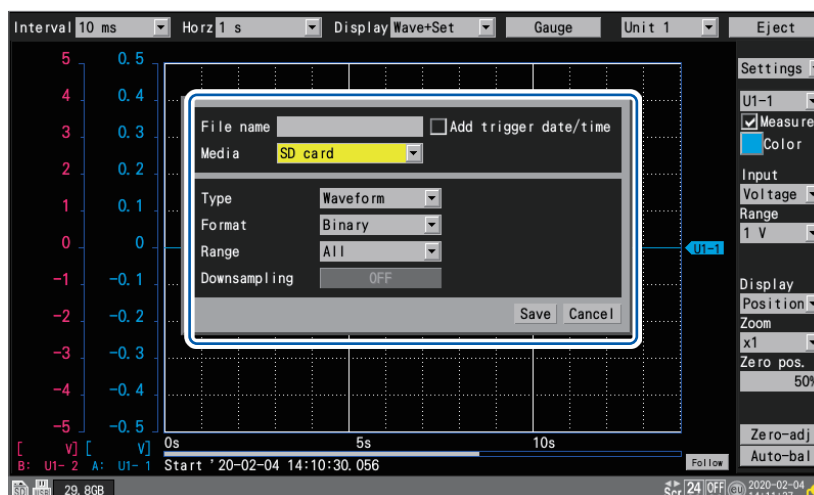

Configure each setting, choose **[Save]**, and then press the **ENTER** key to save data. You can save data to storage media while measurement is ongoing with the auto save (real-time save) function.

For detailed instructions, see "3 Saving and Loading Data" in the Instruction Manual.

Resetting the system (initialization)

You can restore the settings to their factory defaults.

When multiple people are using the instrument, special settings made by the last person to use the instrument may remain in effect.

In such situations, it is recommended to perform a system reset.

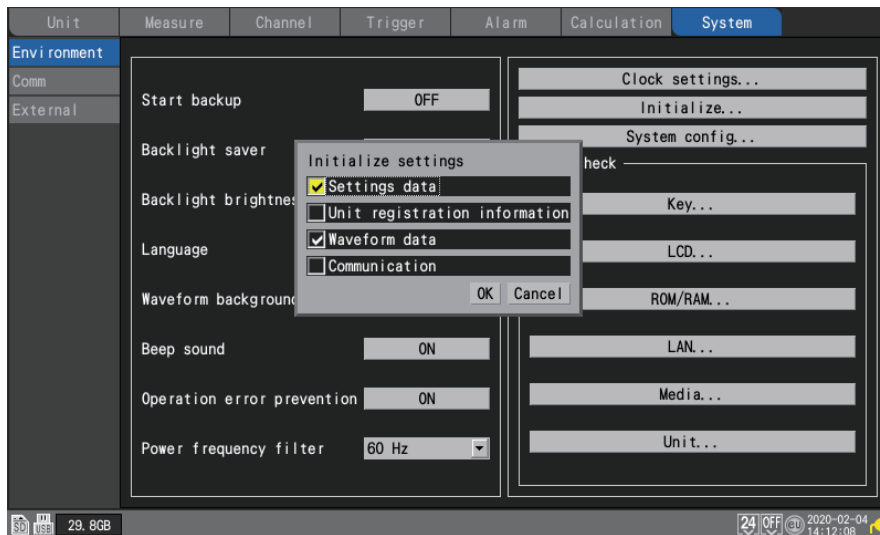

See “7.2 Controlling the System” in the Instruction Manual.

Key lock (disabling keys)

You can disable the instrument’s keys. This feature can be used to prevent accidental or unintended operation.



You can disable the keys by pressing and holding the **ESC** key for at least 3 seconds.

The message **Keylock enabled** will be displayed on the screen.

Pressing a key will cause a message informing the user that the key lock is engaged to be displayed on the screen.

You can disable the key lock by pressing and holding the **ESC** key again for at least 3 seconds.

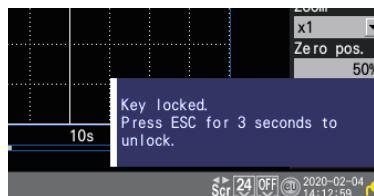
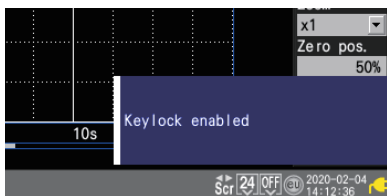

4

Specifications

For detailed information on the instrument's specifications, see "10 Specifications" in the LR8450/LR8450-01 Instruction Manual stored on the accompanying CD.

4.1 Memory HiLogger Basic Specifications

Operating environment	Indoors, Pollution Degree 2, altitude up to 2000 m (6562 ft.)	
Operating temperature and humidity range	-10°C to 50°C (14°F to 122°F), 80% RH or less (non-condensing) (Charging temperature range: 5°C to 35°C [41°F to 95°F])	
Storage temperature and humidity range	-20°C to 60°C (-4°F to 140°F), 80% RH or less (non-condensing)	
Power supply	AC adapter	Z1014 AC Adapter (12 V DC ±10%) AC Adapter rated supply voltage 100 V to 240 V AC (assuming voltage fluctuation of ±10%) AC Adapter rated power supply frequency 50 Hz/60 Hz
	Battery	LR8450 accommodates 2 batteries. Z1007 Battery Pack (When used with AC Adapter, AC Adapter has priority.) Li-ion 7.2 V, 2170 mAh
	External power supply	10 V to 30 V DC
Power consumption	Normal power consumption	Using the Z1014 AC Adapter or 12 V DC external power supply, without Battery Pack With LCD at maximum brightness: 8.5 VA (instrument only) With LCD backlight off: 7 VA (instrument only)
	Maximum rated power	When using the Z1014 AC Adapter 95 VA (including AC Adapter) When using a 30 V DC external power supply 28 VA (while charging battery with LCD at maximum brightness) When using the Z1007 Battery Pack 20 VA (with LCD at maximum brightness)

4.2 Plug-in Module Specifications

U8550 Voltage/Temp Unit

Operating environment	Indoors, Pollution Degree 2, altitude up to 2000 m (6262 ft.)
Operating temperature and humidity range	-10°C to 50°C (14°F to 122°F), 80% RH or less (non-condensing)
Storage temperature and humidity range	-20°C to 60°C (-4°F to 140°F), 80% RH or less (non-condensing)
Maximum input voltage	±100 V DC
Maximum channel-to-channel voltage	±300 V DC
Maximum rated terminal-to-ground voltage	300 V AC, DC (Measurement Category II) Between any input channel (+, -) and the instrument (LR8450/LR8450-01) or between any two modules Anticipated transient overvoltage: 2500 V

U8551 Universal Unit

Operating environment	Indoors, Pollution Degree 2, altitude up to 2000 m (6562 ft.)
Operating temperature and humidity range	-10°C to 50°C (14°F to 122°F), 80% RH or less (non-condensing)
Storage temperature and humidity range	-20°C to 60°C (-4°F to 140°F), 80% RH or less (non-condensing)
Maximum input voltage	±100 V DC
Maximum channel-to-channel voltage	300 V DC (The SoL terminals used to measure resistance bulbs and resistors are not isolated as they are shorted for all channels internally.)
Maximum rated terminal-to-ground voltage	300 V AC, DC (Measurement Category II) Between any input channel (SoH, SoL, +, -) and the instrument (LR8450/LR8450-01) or between any two modules Anticipated transient overvoltage: 2500 V

U8552 Voltage/Temp Unit

Operating environment	Indoors, Pollution Degree 2, altitude up to 2000 m (6562 ft.)
Operating temperature and humidity range	-10°C to 50°C (14°F to 122°F), 80% RH or less (non-condensing)
Storage temperature and humidity range	-20°C to 60°C (-4°F to 140°F), 80% RH or less (non-condensing)
Maximum input voltage	±100 V DC
Maximum channel-to-channel voltage	±300 V DC
Maximum rated terminal-to-ground voltage	300 V AC, DC (Measurement Category II) Between any input channel (+, -) and the instrument (LR8450/LR8450-01) or between any two modules Anticipated transient overvoltage: 2500 V

U8553 High Speed Voltage Unit

Operating environment	Indoors, Pollution Degree 2, altitude up to 2000 m (6562 ft.)
Operating temperature and humidity range	-10°C to 50°C (14°F to 122°F), 80% RH or less (non-condensing)
Storage temperature and humidity range	-20°C to 60°C (-4°F to 140°F), 80% RH or less (non-condensing)
Maximum input voltage	±100 V DC
Maximum channel-to-channel voltage	±300 V DC
Maximum rated terminal-to-ground voltage	300 V AC, DC (Measurement Category II) Between any input channel (+, -) and the instrument (LR8450/LR8450-01) or between any two modules Anticipated transient overvoltage: 2500 V

U8554 Strain Unit

Operating environment	Indoors, Pollution Degree 2, altitude up to 2000 m (6562 ft.)
Operating temperature and humidity range	-10°C to 50°C (14°F to 122°F), 80% RH or less (non-condensing)
Storage temperature and humidity range	-20°C to 60°C (-4°F to 140°F), 80% RH or less (non-condensing)
Maximum input voltage	±0.5 V DC
Maximum channel-to-channel voltage	Non-isolated (all channels share common GND)
Maximum rated terminal-to-ground voltage	30 V rms AC or 60 V DC (between analog input channels and the instrument [LR8450/LR8450-01]) Anticipated transient overvoltage: 330 V

5 Maintenance and Service

5.1 Repairs, Inspections, and Cleaning

WARNING



- Do not attempt to modify, disassemble, or repair the instrument or measurement modules yourself.

High voltages are present in certain parts of the instrument and measurement modules. Attempting the above may cause electric shock or fire.

Replaceable parts and service life

Some parts used in the instrument are characterized by performance that degrades over years of use.

It is recommended to replace these parts regularly to ensure instrument functionality over the long term.

To order replacements, please contact your Hioki distributor.

Part service life varies with the operating environment and frequency of use.

These parts are not guaranteed to operate throughout the period defined by the recommended replacement interval.

Part	Recommended replacement interval	Remarks
Electrolytic capacitors	About 10 years	Boards with these components must be replaced.
LCD backlight	About 100,000 hr.	When brightness falls to half the initial level Service life varies greatly with ambient temperature. Use in hot environments will shorten the service life substantially.
Backup battery	About 10 years	Replace battery when the clock indicates a time that diverges significantly from the actual time as shown when the instrument is plugged in.
Z1007 Battery Pack	About 300 charge/discharge cycles	Once the Battery Pack has been fully charged from empty and then completely discharged 300 times, it will have reached 70% of its initial capacity.
Fan motor	About 5 years	At 23°C

Fuse

The instrument's power supply has a built-in fuse. If the instrument will not turn on, the fuse may have tripped. Fuses cannot be repaired or replaced by the customer. Please contact your authorized Hioki distributor or reseller.

Calibration

IMPORTANT

Regular calibration is necessary in order to obtain correct measurement results at the defined accuracy.

The calibration interval depends on factors such as operating conditions and environment.

Please determine the appropriate calibration interval based on your operating conditions and environment and have Hioki calibrate it accordingly on a regular basis.

Backing up data

When repairing or calibrating the instrument, we may initialize it or update it to the latest software version. It is recommended to back up (save/write) data such as the settings and measurement data before requesting service.

Transporting the instrument

NOTICE



■ **Remove any input modules, recording media, Battery Packs, accessories, and options before transporting the instrument.**

■ **Pack the instrument in the packaging in which it was initially delivered.**

■ **Double-pack the instrument.**

Failure to do so could cause damage during shipment.

When sending the instrument to be repaired, attach a description of the issue. Hioki is unable to guarantee that instruments will not be damaged during shipment.

When transporting the Z1007 Battery Pack on an aircraft

- The Z1007 Battery Pack uses rechargeable lithium-ion batteries.
- The transport of lithium-ion batteries by air is subject to regulations in accordance with United Nations recommendations.
- If you need transport any device that uses the Z1007 Battery Pack by air, contact your authorized Hioki distributor or reseller for instructions.

Cleaning

- If the instrument becomes dirty, moisten a soft cloth with water or a neutral detergent and gently wipe it clean.
- Do not use paint thinner or benzene. Gently wipe the display with a soft, dry cloth.

5.2 Troubleshooting

This section describes what to check when you have a problem and suggests possible solutions.

Before sending the instrument to be repaired

If you believe your instrument might be damaged or malfunctioning, check the following information before contacting your authorized Hioki distributor or reseller.

Symptom	Check items	Solutions
Nothing is displayed on the screen when I press the POWER button. The instrument won't turn on.	• Has the power cord been disconnected?	Properly connect the power cord. (p.46)
	• Has the Battery Pack been properly installed?	Properly install the Battery Pack if it is improperly installed. (p.43)
	• Does the Battery Pack have any remaining charge?	Charge the Battery Pack.
	• Check the output voltage of the AC Adapter. (If the adapter is not outputting 12 V DC, it is broken.)	Contact your authorized Hioki distributor or reseller. The AC Adapter cannot be replaced or repaired by the customer.
Nothing is shown on the screen.	• Is the backlight saver enabled?	Disable the backlight saver. (See "7.1 Configuring Settings" in the Instruction Manual.)
The instrument does not respond when I press keys.	• Is the key lock engaged?	Disengage the key lock. (p.74)
	• Is the key stuck in the depressed position?	Release the key from its depressed position.
No waveform is displayed after measurement starts.	• Is the instrument displaying the [Waiting for pre-trigger...] message? • When using the pre-trigger function, the trigger will not be accepted until the instrument finishes capturing the pre-trigger waveform.	When not using the pre-trigger, disable it. (See "2.2 Enabling the Trigger Function" in the Instruction Manual.)
	• Is the instrument displaying the [Waiting for trigger...] message? • Recording will start when the trigger is activated.	When not using the trigger, disable it. (See "2.2 Enabling the Trigger Function" in the Instruction Manual.)
	• Has the waveform display been disabled?	Enable the waveform display.
The waveform is not changing.	• Are the cables disconnected? • Do the cables have breaks?	Properly connect the cables if they are disconnected or improperly connected. (p.47)
	• Is an appropriate range selected?	Select a more appropriate range. (See "1.3 Configuring Input Channels" in the Instruction Manual.)

Symptom	Check items	Solutions
I can't save data to storage media (SD Memory Card, USB Drive).	• Is Hioki optional media being used?	Use a Hioki optional SD Memory Card or USB Drive. Proper operation of the instrument with SD memory cards and USB drives other than options provided by Hioki is not guaranteed.
	• Has the media been inserted properly?	Insert the media properly. (p.65)
	• Has the media been formatted (initialized)?	Format media when using it for the first time. (See "3.2 Formatting Media" in the Instruction Manual.)
	• Is there enough available space left on the media?	Format or switch media.
	• Are there more than 1000 files in the folder? • The file screen can display a maximum of 1000 files.	Keep the number of files stored in every folder to a maximum of 1000. If a folder contains an excessive number of files, it will take a while to store. You can copy and delete files. (See "3.5 Managing Data" in the Instruction Manual.)
I can't charge the Z1007 Battery Pack (the CHARGE LED does not light up).	• Are you trying to charge the Battery Pack outside an ambient temperature range of 5°C to 35°C?	Charge the Battery Pack within an ambient temperature range of 5°C to 35°C.
	• Was the instrument stored for an extended period of time with a Battery Pack installed?	The Battery Pack may have deteriorated. (p.33) Please purchase a new Battery Pack. Remove the Battery Pack before storing the instrument if it will not be used for one month or more.
The length of time I can power the instrument with the Z1007 Battery Pack has significantly decreased, even right after charging.	• The Battery Pack's capacity may have diminished due to deterioration.	The Battery Pack may have deteriorated. (p.33) Please purchase a new Battery Pack.
I've installed the Z1007 Battery Pack, but I can't turn on the instrument.	• Is the instrument being used in a cold place? • Due to the Battery Pack's characteristics, the instrument may not start up if the Battery Pack is cold.	Take one or more of the following measures: - Attach two Battery Packs in the instrument. - Warm the Battery Pack to room temperature. - Replace the Battery Pack with a standby Battery Pack.

If you can't identify the cause of your issue

Perform a system reset (initialization). For more information about system resets, see "Resetting the system (initialization)" (p. 74).

Error messages

There are two types of error message: errors and warnings.

Errors encountered by the instrument are displayed on the screen.

Use the tables shown below to check the nature of the error and review suggested solutions.

Error messages

No.	Message	Solutions
ERR_BT01	Internal temperature of the instrument is abnormal. After saving the necessary data, turn off the power.	Check the operating temperature environment and verify that the fan is operating. If this message is displayed while using the instrument within the operating temperature range, have it repaired.
ERR_SY01	Program failure. Repair required.	Turn off the instrument and have it repaired.
ERR_SY02	Unit connection error. Current unit configuration is not valid. Please review the connection.	Verify that the measurement module is properly connected.
ERR_SY03	The battery has been removed.	Check the Battery Pack connection.
ERR_SY04	Clock correction circuit error. Repair required.	Turn off the instrument and have it repaired.
ERR_SY05	Update failed	Turn off the instrument and repeat the update. If the update fails again, have the instrument repaired.
ERR_SY06	Internal temperature of the instrument is abnormal.	Check the operating temperature environment and verify that the fan is operating. If this message is displayed while using the instrument within the operating temperature range, have it repaired.
ERR_SY07	Unit error. UNIT No._	The instrument cannot correctly detect modules (UNITs). The instrument may be damaged. Have it repaired.
ERR_SY08	Unit data does not match the directly connected unit mounted on the main device	The connected plug-in modules do not match the plug-in modules configuration saved in the loaded setting data. Check the configuration of the connected plug-in modules.
ERR_SY09	Hardware error detected.	Turn off the instrument and have it repaired.
ERR_FL01	File processing error	While the instrument is handling files stored on the SD Memory Card or USB Drive, an anomaly has unexpectedly occurred. Switch media or turn off the instrument.
ERR_FL02	Waveform data not found	Acquire waveform data.
ERR_FL03	Numerical calculation data not found	Execute numerical calculation.
ERR_FL04	Cannot load this file	The selected file may be of an unloadable form or damaged. Load an appropriate file.
ERR_FL05	Insufficient storage memory	The file cannot be stored because the media starts to run out of space. Delete unnecessary files to free up space. Alternatively, switch media.

No.	Message	Solutions
ERR_FL06	Media is full or cannot delete oldest wave file	The file was not able to be stored because the SD Memory Card or the USB Drive starts to run out of space. Delete unnecessary files to free up space. Alternatively, switch media.
ERR_FL07	This folder cannot be deleted or renamed on the instrument.	This message is displayed to prevent accidental deletion of data folders. Use a computer to delete or rename folders.
ERR_FL08	Confirm the A-B cursor position	The A/B cursors are inappropriately placed (for example, outside the waveform range). Check the positions of the A/B cursors.
ERR_FL09	File is damaged	The file cannot be loaded because the information in it is damaged. Load an appropriate file.
ERR_FL10	Duplicate name.	Enter a unique file name.
ERR_FL11	This folder/file is protected.	Folders and files with the read-only attribute cannot be deleted using the instrument. Use a computer to delete.

Warning messages

- Press any key to clear the display.

No.	Message	Solutions
WARN_BT01	Internal temperature of the instrument is rising. Please check the operating temperature environment and installation environment.	Check the conditions under which the instrument has been installed. See "Installing the instrument" (p.8).
WARN_SY01	Battery low. Connect the AC adapter to the instrument, or shut down and replace the battery.	Connect the AC Adapter to the instrument. See "2.3 Connecting the AC Adapter" (p.45).
WARN_SY02	Battery low. Connect the AC adapter to the wireless unit.	Connect the AC Adapter to the wireless module. See "2.3 Connecting the AC Adapter" (p.45).
WARN_SY03	Internal temperature of the instrument has risen. Check the operating environment.	Check the conditions under which the instrument has been installed. See "Installing the instrument" (p.8).
WARN_SY04	Internal temperature of the instrument has risen. Stopping external power output. Check the operating environment.	Check the conditions under which the instrument has been installed. See "Installing the instrument" (p.8). When voltage output stops, configure the setting again as necessary. See "8.1 Configuring Voltage Output (VOUTPUT)" in the Instruction Manual.
WARN_SY05	No channel selected for measurement.	The measurement preferences of all channels are set to Off. Set one or more of them to On before starting measurement.
WARN_SY06	Battery low. Stopping auto save. Connect the AC adapter to the instrument, or shut down and replace the battery.	The battery starts to run out. Provide power to the instrument using the AC adapter or an external power supply. Alternatively, turn off the instrument, and then replace the batteries.
WARN_SY07	Failed to initialize.	Initialize the system again. Key operation during the initialization of the instrument may cause an error. Do not operate any keys during the initialization.

No.	Message	Solutions
WARN_FL01	Storage media not found.	Insert an SD Memory Card or a USB Drive.
WARN_FL02	Firmware update not possible due to low battery. Connect the AC adapter and try again.	Updating the instrument is prohibited if the battery starts to run out. Provide power to the instrument using the AC adapter or an external power supply. Alternatively, charge the battery sufficiently.
WARN_FL03	Firmware update not possible due to weak signal conditions. Improve the communication environment and try again.	Check if the wireless modules are on. Check the state of communications with the wireless modules. If the communications are disrupted, move the equipment to improve the communications state.
WARN_FL04	The firmware cannot be updated because the battery of the wireless unit is low. Connect the AC adapter and try again.	Updating the instrument is prohibited if the battery of the wireless modules starts to run out. Connect the AC adapter before updating the instrument.
WARN_FL06	Insert SD memory card or USB flash drive.	Insert an SD Memory Card or a USB Drive.
WARN_FL07	Storage media is almost full	The media starts to run out of space. Switch media.
WARN_FL08	Unsaved data will be deleted shortly. Please insert storage media.	This message is displayed when data occupies half the internal buffer memory space or more after the start of the real-time save operation with no media inserted. Insert an SD Memory Card or a USB Drive.
WARN_FL09	Unsaved data present.	An SD Memory Card or a USB Drive is not inserted. Alternatively, available space may start to run out. Insert an SD Memory Card or a USB Drive, and then manually save necessary data.
WARN_FL10	File name including the folder is too long - file operation unsuccessful.	The pass name entered consists of too many characters. Use a computer to rename the folder stored on the SD Memory Card or the USB Drive so that the folder name becomes shorter than the limit.
WARN_FL11	Busy	Wait for the completion of the process.
WARN_SU01	SSID not entered	Enter the [SSID] for the access point in the wireless LAN settings. See "9.4 Exporting Acquired Data to a Computer Over Wireless LAN" in the Instruction Manual.
WARN_SU02	Select a channel to execute auto balance.	Choose channels for which you want to execute auto-balance.
WARN_COM01	Wireless unit cannot be searched because wireless LAN setting is OFF or the wireless LAN is in station mode.	Set the wireless LAN mode to On. Switch the wireless LAN mode over to [Connect wireless unit] .
WARN_COM02	USB drive mode cannot be used because it is connected from an FTP client.	Following the completion of the FTP communications, switch over USB drive mode.
WARN_FTPEC00	Failed to connect to FTP server	Check the setting and connection of the FTP data auto-transmission.

No.	Message	Solutions
WARN_FTFC01	FTP data transfer failed. File not found.	Manually obtain files that have not transferred from the instrument with the FTP. Alternatively, load files from the media set as the destination location.
MSG_FL10	The directly connected unit and settings data do not match. Do you want to restore the backed up data?	The connected plug-in modules do not match the plug-in modules configuration saved in the loaded setting data. Check the configuration of the connected plug-in modules.
MSG_SU04	The text format cannot be selected with the current recording interval settings.	If you wish to save data in text format, use a longer recording interval. If you do not wish to change the recording interval, save data in binary format. See “1.2 Setting Measurement Conditions” in the Instruction Manual.
MSG_SU05	CSV auto save has been set. Specified record interval not configurable.	If you wish to use a shorter recording interval, save data in binary format. If you cannot switch to text format, use a longer recording interval. See “Auto save (real-time save)” in the Instruction Manual.
MSG_SU06	10ms recording interval cannot be configured. Number of channels exceeding the limit in use.	If there are too many channels for which measurement is enabled, you will not be able to set the recording interval to 10 ms. Enable measurement for 15 or fewer channels.
MSG_SU07	Settings for recording interval has been optimized. (Recording time, file division time, pre-trigger, horizontal axis, etc.)	Check the following settings, which may have changed: <ul style="list-style-type: none"> • [Recording interval] • [Split time] under [File splitting] • [Pre-trigger] • [Horizontal axis] (time per division) • Measurement module data update interval (changed to optimal interval during auto operation) • [Split time] in [Time split calculation] under [Numerical calculation]

- When a warning occurs, a message will be displayed for several seconds.

No.	Message	Solutions
–	NTP client disabled	Set the NTP client function in the NTP settings to [ON] . See “Synchronizing the time” in the Instruction Manual.
–	No server address entered	Enter the server address in the NTP settings. See “Synchronizing the time” in the Instruction Manual.
–	Invalid key	The pressed key is disabled, for example because measurement is in progress. Press the key after the operation completes.
–	Modification not available while measuring	Press the STOP key to stop measurement and then change the setting.
–	Settable range exceeded	The entered value does not fall within the valid setting range. Enter an appropriate value.

No.	Message	Solutions
–	Pre-trigger time and settings modified	Changing the recording interval or recording time may shorten the time that can be set for the pre-trigger. Check the updated pre-trigger settings.
–	Trigger or alarm setting value of this channel modified	The trigger or alarm settings have changed. Check the updated settings. See “2.2 Enabling the Trigger Function” and “4.1 Configuring Alarms” in the Instruction Manual.
–	Burn-out settings modified	The wire break detection function has been set to [OFF] . To use the wire break detection function, either increase the recording interval or reduce the number of channels being measured. See “1.2 Setting Measurement Conditions” in the Instruction Manual.
–	Cannot activate Burn Out (broken-wire) detection. Set the unit update interval to automatic or a rate slower than current settings.	The user-specified setting does not support the wire break detection. Set the data refresh interval to [Auto] or an interval longer than that presently set. See “1.2 Setting Measurement Conditions” in the Instruction Manual.
–	File partition period modified	Changing the recording interval will cause the segment time to change. Check if the settings are appropriate.
–	Recording interval modified	The measurement preferences of all channels of the High Speed Voltage Unit and Strain Unit have been set to [OFF] , forcing the recording interval setting to change. Check the updated recording interval.
–	Auto-save format changed from CSV to waveform	The auto save recording format was changed to binary (MEM). The recording interval cannot be decreased when using text format (CSV). If you wish to save data in text (CSV) format, use a longer recording interval. See “Auto save (real-time save)” in the Instruction Manual.
–	Settings for external I/O3 modified to external trigger	The external input 3 terminal was set to [Trigger input] because the external trigger was set to [ON] . Check if the settings are appropriate. See “2.5 Applying Triggers Based on External Sources” in the Instruction Manual.
–	Horizontal axis modified	The horizontal axis (time per division) was changed because the recording interval was changed. Check if the settings are appropriate. The time per division cannot be set to a value that is shorter than the recording interval. See “Other display settings” in the Instruction Manual.

No.	Message	Solutions
–	Division time for numerical calculation modified	The [Split time] setting under [Numerical calculation] was changed because the recording interval was changed. Check if the settings are appropriate. See “Measurement operation” in the Instruction Manual.
–	Recording time settings modified	The recording time was changed because the recording interval was changed. Check if the settings are appropriate. See “Measurement operation” in the Instruction Manual.
–	File rename failed	The filename cannot be changed. Check whether there’s another file with the same name.
–	Copy file failed	The file cannot be copied. Check whether there’s another file with the same name.
–	Delete file failed	The file cannot be deleted. Verify that the media’s write protect switch has been disengaged.
–	Format media failed	The media cannot be formatted (initialized). Verify that the media’s write protect switch has been disengaged.
–	Invalid file name	The filename is incorrect. Check the characters used in the filename. In addition, verify that there is not another file with the same name.
–	Settings data normalized	Changing a specific setting can force some other settings to change under measurement constraints. Check if appropriate settings have been set before starting measurement.
–	Measurement will start with backed up settings data	The connected plug-in modules do not match the plug-in modules configuration saved in the loaded setting data. Check the configuration of the connected plug-in modules.
–	Unit update interval modified	There are some conditions where changing a specific setting can force the data refresh interval to change. Check if an appropriate data refresh rate of the module has been set.
–	Failed to eject SD card.	Any attempts to eject the SD Memory Card in the middle of internal processing may fail. Wait for a while or cycle the instrument. After that, eject it.
–	Failed to eject USB flash drive.	Any attempts to eject the USB Drive in the middle of internal processing may fail. Wait for a while or cycle the instrument. After that, eject it.
–	Aborted.	Any attempts to interrupt a manual-saving process may cause this message to appear. If it was unintentional, perform saving again.

No.	Message	Solutions
–	Scaling conversion error.	Any attempts to configure a disabled scaling setting may cause this message to appear. (Example: Attempting to set the scaling slope at zero) Set an appropriate figure.
–	Cannot set to text format. Set the recording interval to [20 ms] or more.	The user-specified setting does not support text-format saving of waveform data. Set the recording interval at [20 ms] or longer.
–	Cannot set to text format. Set the recording interval to [10 ms] or more.	The user-specified setting does not support text-format saving of waveform data. Set the recording interval at [10 ms] or longer.
–	Recording interval cannot be changed. Set waveform data storage format to binary format.	The user-specified setting does not support a recording interval of less than [10 ms] . Set the saving format to binary. Alternatively, reduce the number of measurement channels.
–	Waveform data storage format has been changed to binary format.	The number of channels to be measured exceeds the upper limit supported by the user-defined recording interval. To save data in text format, use the longer recording length, or reduce the number of channels to be measured.
–	Out of data range.	No event marks or jump data points of the warning history can be found.

5

5.3 Disposing of the Instrument

The instrument has a built-in backup lithium battery. When disposing of the instrument, remove the lithium battery and dispose of it in accordance with local regulations.

⚠ WARNING



- **Turn off the power button and disconnect the power cord and all cables before removing the lithium battery.**

Failure to do so could cause electric shock.



- **Store the removed lithium battery out of reach of children.**

Failure to do so could allow young children to accidentally ingest battery.

CALIFORNIA, USA ONLY

Perchlorate Material - special handling may apply.
See www.dtsc.ca.gov/hazardouswaste/perchlorate

Removing the lithium battery

You will need: A Phillip's head screwdriver (No. 2) and a pair of needle-nose pliers

- 1** Verify that the instrument has been turned off and disconnect the power code and all cables.
- 2** Turn over the instrument and remove the six screws shown in the figure.

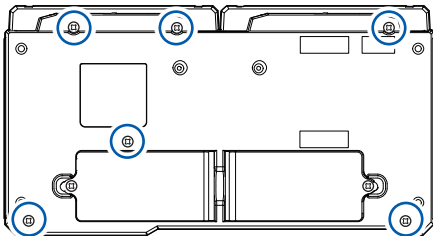

- 3** Remove the lower case.
- 4** Pull up on the lithium battery on the printed circuit board and cut the positive and electrode leads with the plier.

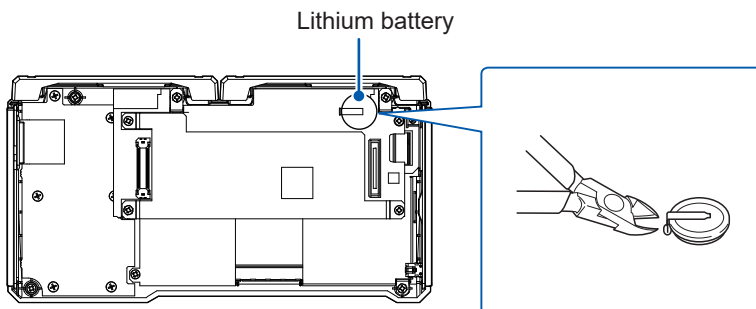

5.4 FAQ (Frequently Asked Questions)

Installation and measurement operation

Question	Answer	See
How long can the instrument operate on battery power?	The instrument can operate for about 2 hours on one fully charged Z1007 Battery Pack, or for about 4 hours on two fully charged Battery Packs. (Reference value at 23°C)	“Continuous operating time on Battery Pack power” (p.44)
What will happen to data if the power goes out during measurement?	No measurement data will remain. Against a power failure, using the Z1007 Battery Pack is recommended.	“2.2 Installing a Battery Pack” (p.40)
Can I resume recording once the power comes back on?	Recording can be resumed when the power comes back on by using the start state retention function.	See “7.1 Configuring Settings” in the Instruction Manual.
Why does temperature error increase immediately after the instrument is moved to a location with a significantly different temperature?	When measuring temperature with a thermocouple, the terminal temperature is measured by an internal temperature sensor and used to perform reference junction compensation. When the ambient temperature changes abruptly, the thermal balance between the terminal block and the temperature sensor is interrupted, causing temperature error. When moving the instrument to a location with a significantly different temperature, allow the instrument to sit for at least 60 minutes before performing measurement.	–
How can I correct for differences in the zero position of different inputs?	The zero-adjustment function can be used to correct for such differences. The zero-adjustment function is disabled for the Strain Units (U8554, LR8534). You can correct the zero position of the Strain Unit using the auto-balance.	See “1.8 Performing Zero Adjustment” “Measuring strain” in the Instruction Manual.
I’m seeing waveforms for unconnected channels even though I’m only providing input for channel 1.	If the input terminals are left open, the instrument may display waveforms that have been affected by other channels. Either disable the channels with open inputs or short the positive and negative terminals.	–
Can I assign a mark during measurement and search for it later?	You can assign event marks in waveforms. You can jump to event mark locations on the display.	See “5.1 Assigning Event Marks during Measurement” in the Instruction Manual.

Settings

Question	Answer	See
How can I hide unnecessary channels?	Set the waveform display color to [OFF].	–
Can I measure temperature when there’s a voltage?	You can measure temperature as long as the voltage does not exceed the maximum channel-to-channel voltage or the maximum channel-to-ground voltage. If the voltage exceeds either of those values, avoid applying the voltage to the input terminals, for example by using a non-grounded thermocouple.	–

Question	Answer	See
Should I set reference junction compensation to [EXT] or [INT] ? What is the accuracy?	Use the [INT] (internal) setting when connecting the thermocouple to the module's terminal block. The measurement accuracy is determined by adding the temperature measurement accuracy to the reference junction compensation accuracy. Example: When measuring a temperature within the range of 0°C to 100°C with a K thermocouple The accuracy is obtained by adding the reference junction compensation accuracy of $\pm 0.5^{\circ}\text{C}$ to the temperature measurement accuracy of $\pm 0.5^{\circ}\text{C}$, yielding a value of $\pm 1.0^{\circ}\text{C}$.	–

Triggers

Question	Answer	See
The instrument is displaying the message [Waiting for trigger...] , and it won't make measurements.	When a trigger has been set, recording will not start until the trigger conditions are satisfied. If the trigger setting is off, you can start recording by pressing the START key.	See "2 Trigger Function" in the Instruction Manual.

Saving data

Question	Answer	See
Can I use any commercially available SD memory card or USB drive?	Use only Hioki optional SD Memory Cards or USB Drives. Proper operation is not guaranteed when using commercially available SD memory cards USB drives.	–
	USB drives with security functions such as fingerprint authentication cannot be used.	–
Can I switch media while auto save is in progress?	Choose [Eject] on the top right of the waveform screen and press the ENTER key.	See "Replacing (ejecting) media during real-time save operation" in the Instruction Manual.
For how many days can the instrument record?	Available recording length settings are determined by the number of channels and the recording interval. Example: For a recording interval of 1 s with 15 channels and 1 GB media, you can record for about 400 days.	See "11.8 File Size" in the Instruction Manual.
Can I view waveform data in Excel [®] ?	You can convert automatically saved waveform (binary) data into text format (CSV) data with the Logger Utility. You can load CSV files with Excel [®] .	See "9.1 Using the Logger Utility" in the Instruction Manual.
Can I view time values in waveform data (CSV format) as absolute rather than relative times?	Set [Display horizontal axis] to [Date] . <ul style="list-style-type: none"> •Time: Time elapsed since the start of measurement •Date: Actual time (time and date) •Data points: Number of data points since the start of measurement 	See "Other display settings" in the Instruction Manual.
What is the difference between the ".MEM" and ".LUW" extensions?	<ul style="list-style-type: none"> •".MEM": Binary waveform data that can be loaded by the instrument or the Logger Utility •".LUW": Logger Utility waveform data that cannot be loaded by the instrument 	–

5.5 Open-source software

This instrument includes software to which GNU General Public License GNU Lesser General Public License and other licenses are applied.

You have the right to obtain, modify, and redistribute the source code of the software under these licenses.

For details, visit the following website.

<https://www.hioki.com/en/support/oss>

Hioki would prefer you not to direct any inquiries on the content of the source cord.

Index

A

A/B cursors Instruction Manual
AC Adapter 33, 45
Accessories 4
Alarm output 60, Instruction Manual
Alarms Instruction Manual
Auto save Instruction Manual

B

Backlight brightness Instruction Manual
Backlight saver Instruction Manual
Backup battery 79
Battery Pack 33
 Charging 44
 Continuous operating hours 44
 Installation 40

C

Cables
 Connections 47
Carrying Case 34
Cleaning 80
Clock Instruction Manual
Configuration navigator 24, Instruction Manual
Configuration process 70
Connecting external control signals
 63, Instruction Manual
Connecting voltage cables 50
Connecting voltage output 61
Connection confirmation labels 56
Controlling the system Instruction Manual
Crimp terminals 48

D

Data refresh interval Instruction Manual
DIP switches 58
Disposal 90

E

Error messages 83
Event marks Instruction Manual
External triggers Instruction Manual
EXT. I/O Instruction Manual

F

FAQ (frequently asked questions) 91
File size Instruction Manual
Fixed Stand 33
Formatting media Instruction Manual
Fuse 79

H

Horizontal axis display Instruction Manual
HTTP server Instruction Manual
Humidity Sensor 33, 53

I

Icon 27
Initialization 74, Instruction Manual
Input channels Instruction Manual
Inspections 47

K

Key controls 24
Key lock 74

L

Labels 56
LAN connector 26
Loading data Instruction Manual
Logger Utility Instruction Manual

M

MAC address 25
Main tabs 71
Maintenance 79
Measurement
 Start and stop 73
Measurement operation Instruction Manual
Measuring strain Instruction Manual
Measuring voltage Instruction Manual

N

Numerical calculations Instruction Manual

O

Observing waveforms Instruction Manual
Operation 71
Options 5, 32

P

Plug-in modules 29, 32, 76
 Connections 38
POWER 64
Power supply 64
Pulse 59

R

Real-time save Instruction Manual
 Replacing media Instruction Manual
 Repairs 79, 81
 Resistance bulbs 52
 Resistors..... 55

S

Saving data..... 73, Instruction Manual
 Scaling Instruction Manual
 SD card slot..... 26
 SD Memory Cards..... 34, 65
 Serial number 25, 29, 31
 Service life 79
 Setting measurement conditions Instruction Manual
 Settings and operation Instruction Manual
 Specifications 75, Instruction Manual
 Built-in modules..... 76
 Strain gage connections 56
 Strain gage-type converters 56
 Sub tabs 71
 Synchronizing the time Instruction Manual
 System reset..... 74, Instruction Manual

T

Text entry Instruction Manual
 Thermocouple connections 50
 Transport 80
 Trigger function Instruction Manual
 Troubleshooting..... 81

U

USB connector 26
 USB Drives 34, 65

V

Value entry Instruction Manual
 Voltage output..... Instruction Manual

W

Warning messages 84
 Waveform calculations Instruction Manual
 Waveform display Instruction Manual
 Wireless certification number 25
 Wireless LAN Instruction Manual
 Wireless LAN Adapter 33
 Wireless modules 30, 32

Z

Z1007 33, 40
 Z1008 33, 45
 Z1014 33, 45
 Zero adjustment Instruction Manual