



5 Commonwealth Ave
Woburn, MA 01801
Phone 781-665-1400
Toll Free 1-800-517-8431



Visit us at www.TestEquipmentDepot.com

NAVAC

Empowering you to work smarter

Cordless Power Flaring Tool

NEF6LM User Manual



Failure to follow warnings could
result in death or serious injury.

**SAVE THIS MANUAL
FOR FUTURE REFERENCE**

MADE IN CHINA

BREAK FREE
CORDLESS SERIES

Contents

Structure and Technical Parameters..... 01

Operation Instruction..... 03

Troubleshooting..... 05

Exploded View and Parts List..... 06

Safety Guide

Caution: Read this manual thoroughly before using.

- Keep the working area clean and tidy.
- Do not operate while under the influence of alcohol.
- Keep children and untrained people from using.
- Use original parts and auxiliary.
- Long time using may overheat its motor which activate overheat protection.
- Temperature higher than 158°F (70°C) or lower than 41°F (5°C) may activate the motor overheat or subcooled protection.
- Don't dismantle NEF6LM at random which may void warranty.
- Product is warranted against defects in materials and workmanship for two years from the date of purchase.
- Dispose the battery according to local regulations.
- Pending patent.

Structure

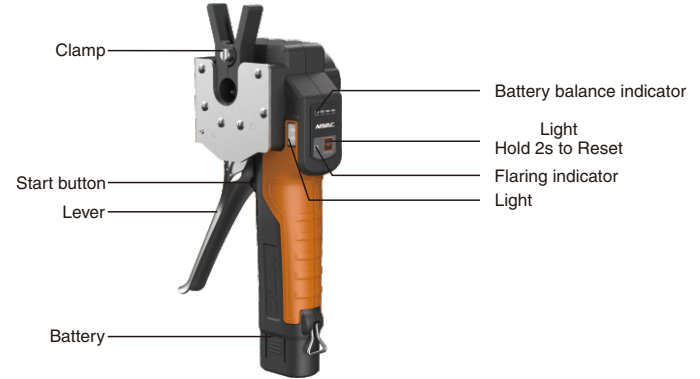

Technical Parameters

Model	NEF6LM
Tubing Type	Copper
Tubing OD	1/4", 3/8", 1/2", 5/8", 3/4"
Power	DC motor
Cone Speed	120 RPM
Battery Capacity	Up to 100 flares per charge
Time to Flare	Complete a flare in < 30 seconds
Dimension	10"x4"x4" (265x101x100mm)
Weight	2.9 lbs (1.3kg)

Battery pack

Battery	7.4V 2Ah 14.8Wh
Quick Charge	30 minutes
Ambient Temperature	41°F-104°F (5°C-40°C)

Charger

Power Supply	AC 100-240V (50/60Hz) 50W
Output Voltage	8.4V
Output Current	3.5A
Ambient Temperature	41°F-104°F (5°C-40°C)

Table 1

Light/Hold 2s to Reset Button:

- Press to show battery life.
- Press to turn on/off the light.
- Press 2 seconds to reset (draw back) the cone.

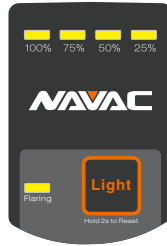
**Operation Instruction****1. Get the copper placed.**

- Open the clamp by pressing the legs and insert the tubing.
- Use the baffle to set the correct depth of the tubing.

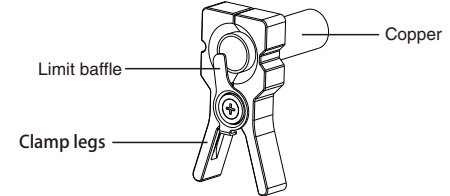

Figure 1

2. Get the clamp placed.

- Keep the lever open and put in the clamp. A locked lever resists the clamp being placed.
- Push the lever inward to lock the clamp.

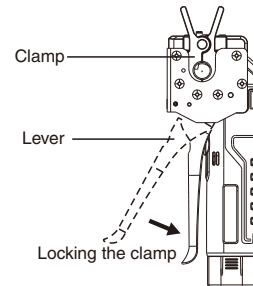

Figure 2

Caution:
Make sure hash marks lineup. Otherwise it may cause a defective flare and damage the clamp.

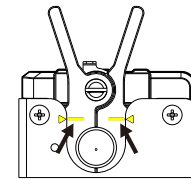

Figure 3

3. Press the START button to flare.**Caution:**

- Don't open the lever during flaring, otherwise the automatic flaring stops.
- If it happens, press the reset button 2 seconds to draw back the cone.
- Make sure the clamp is still horizontally placed.
- Press inward the lever to lock the clamp again.
- Press the start button to reflare.

4. It takes less than 30 seconds to complete a flare automatically.

- After the flaring indicator turns off, open the lever.
- Remove the clamp and tubing.

Battery Charge

1. Charge battery when the last indicator flashes which means low battery.

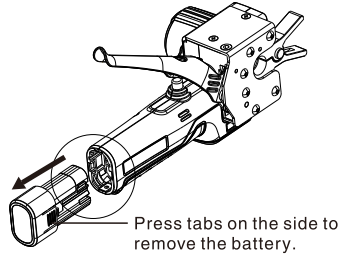

Figure 4

2. Make sure the battery pack is connected properly.

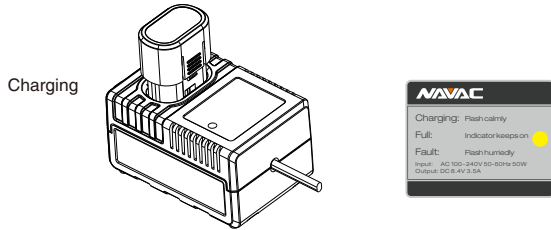

Figure 5

3. Place back the battery pack.

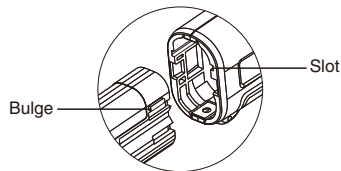

Figure 6

Troubleshooting

Problem	Possible cause	Solution
Flaring indicator flashes once cyclically.	Short circuit.	Contact NAVAC TechSupport.
Flaring indicator flashes twice cyclically.	Battery ID not recognized.	Use an original battery.
Flaring indicator flashes three times cyclically.	Overheat or subcooled of the battery pack.	Cool down or warm up the battery pack.
Flaring indicator flashes four times cyclically.	Overload. Or the cone cannot be reset.	Contact NAVAC TechSupport.
It does not flare or it stops during flaring.	Low battery balance.	Charge the battery.
	Motor or circuit board failure.	Contact NAVAC TechSupport.
	Dirty on the batter connections.	Clean the connections.
The copper flare is too small.	Lever's locking is loose.	Tighten the lever. (Figure 7)
	Copper does not touch the baffle.	Make them contact.
	Copper not deburred.	Debur the copper.

Charger

Charger indicator flashes hurriedly.	Battery damaged.	Try another battery.
--------------------------------------	------------------	----------------------

Table 2

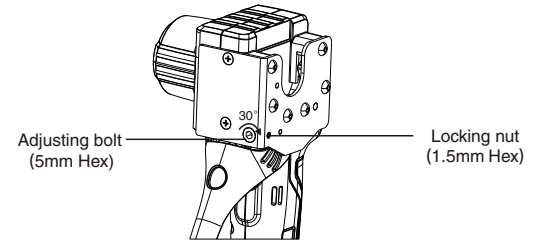

Figure 7

Caution:

- To tighten the lock, loose the locking nut first.
- Then turn the bolt clockwise 30 degree each time to check the tightness.
- Don't turn clockwise too much each time because it may over-tight the lever and cause damage.

Exploded View

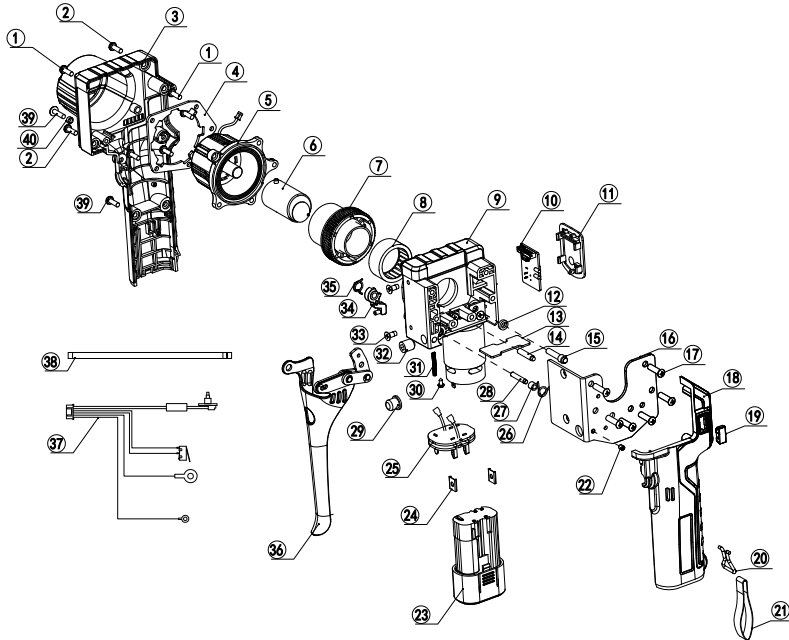

Figure 8

Spare Parts List

Ref No.	Part No.	Item
1	PNEF1	Screw
2	PNEF2	Screw
3	PNEF3	Right Cover
4	PNEF4	Plate
5	PNEF5	Chamber Assembly
6	PNEF6	Axis Assembly
7	PNEF7	Turbine Bushing
8	PNEF8	Bearing
9	PNEF9	Transmission Chamber
10	PNEF10	Circuit Board
11	PNEF11	Display Panel
12	PNEF12	Bushing
13	PNEF13	Subplate
14	PNEF14	Stop Pin
15	PNEF15	Pin
16	PNEF16	Front Cover
17	PNEF17	Screw
18	PNEF18	Cover
19	PNEF19	LED Plate
20	PNEF20	Ring
21	PNEF21	Strap
22	PNEF22	Screw
23	PNEF23	Battery Pack
24	PNEF24	Dead Plate
25	PNEF25	Circuit Board
26	PNEF26	Spring
27	PNEF27	Bushing
28	PNEF28	Pin
29	PNEF29	Button
30	PNEF30	Screw
31	PNEF31	Spring
32	PNEF32	Screw
33	PNEF33	Screw
34	PNEF34	Switch
35	PNEF35	Spring
36	PNEF36	Lever
37	PNEF37	Circuit
38	PNEF38	Wire
39	PNEF39	Screw
40	PNEF40	Bushing

Table 3