

# Keysight U1461A Insulation Multimeter/ U1453A Insulation Tester

# Notices

## Copyright Notice

© Keysight Technologies 2014–2016

No part of this manual may be reproduced in any form or by any means (including electronic storage and retrieval or translation into a foreign language) without prior agreement and written consent from Keysight Technologies as governed by United States and international copyright laws.

## Manual Part Number

U1461-90003

## Edition

Edition 9, November 18, 2016

## Printed in:

Printed in Malaysia

## Published by:

Keysight Technologies  
Bayan Lepas Free Industrial Zone,  
11900 Penang, Malaysia

## Technology Licenses

The hardware and/or software described in this document are furnished under a license and may be used or copied only in accordance with the terms of such license.

## Declaration of Conformity

Declarations of Conformity for this product and for other Keysight products may be downloaded from the Web.

## U.S. Government Rights

The Software is “commercial computer software,” as defined by Federal Acquisition Regulation (“FAR”) 2.101. Pursuant to FAR 12.212 and 27.405-3 and Department of Defense FAR Supplement (“DFARS”) 227.7202, the U.S. government acquires commercial computer software under the same terms by which the software is customarily provided to the public. Accordingly, Keysight provides the Software to U.S. government customers under its standard commercial license, which is embodied in its End User License Agreement (EULA). The license set forth in the EULA represents the exclusive authority by which the U.S. government may use, modify, distribute, or disclose the Software. The EULA and the license set forth therein, does not require or permit, among other things, that Keysight: (1) Furnish technical

information related to commercial computer software or commercial computer software documentation that is not customarily provided to the public; or (2) Relinquish to, or otherwise provide, the government rights in excess of these rights customarily provided to the public to use, modify, reproduce, release, perform, display, or disclose commercial computer software or commercial computer software documentation. No additional government requirements beyond those set forth in the EULA shall apply, except to the extent that those terms, rights, or licenses are explicitly required from all providers of commercial computer software pursuant to the FAR and the DFARS and are set forth specifically in writing elsewhere in the EULA. Keysight shall be under no obligation to update, revise or otherwise modify the Software. With respect to any technical data as defined by FAR 2.101, pursuant to FAR 12.211 and 27.404.2 and DFARS 227.7102, the U.S. government acquires no greater than Limited Rights as defined in FAR 27.401 or DFAR 227.7103-5 (c), as applicable in any technical data.

## Warranty

THE MATERIAL CONTAINED IN THIS DOCUMENT IS PROVIDED “AS IS,” AND IS SUBJECT TO BEING CHANGED, WITHOUT NOTICE, IN FUTURE EDITIONS. FURTHER, TO THE MAXIMUM EXTENT PERMITTED BY APPLICABLE LAW, KEYSIGHT DISCLAIMS ALL WARRANTIES, EITHER EXPRESS OR IMPLIED, WITH REGARD TO THIS MANUAL AND ANY INFORMATION CONTAINED HEREIN, INCLUDING BUT NOT LIMITED TO THE IMPLIED WARRANTIES OF MERCHANTABILITY AND FITNESS FOR A PARTICULAR PURPOSE. KEYSIGHT SHALL NOT BE LIABLE FOR ERRORS OR FOR INCIDENTAL OR CONSEQUENTIAL DAMAGES IN CONNECTION WITH THE FURNISHING, USE, OR PERFORMANCE OF THIS DOCUMENT OR OF ANY INFORMATION CONTAINED HEREIN. SHOULD KEYSIGHT AND THE USER HAVE A SEPARATE WRITTEN AGREEMENT WITH WARRANTY TERMS COVERING THE MATERIAL IN THIS DOCUMENT THAT CONFLICT WITH THESE TERMS, THE WARRANTY TERMS IN THE SEPARATE AGREEMENT SHALL CONTROL.

## Safety Information

### CAUTION









A CAUTION notice denotes a hazard. It calls attention to an operating procedure, practice, or the like that, if not correctly performed or adhered to, could result in damage to the product or loss of important data. Do not proceed beyond a CAUTION notice until the indicated conditions are fully understood and met.

### WARNING

A WARNING notice denotes a hazard. It calls attention to an operating procedure, practice, or the like that, if not correctly performed or adhered to, could result in personal injury or death. Do not proceed beyond a WARNING notice until the indicated conditions are fully understood and met.

## Safety Symbols

The following symbols on the instrument and in the documentation indicate precautions which must be taken to maintain safe operation of the instrument.

	Direct current (DC)		Caution, risk of electric shock
	Alternating current (AC)		Caution, risk of danger (refer to this manual for specific Warning or Caution information)
	Both direct and alternating current	<b>CAT III 1000 V</b>	Category III 1000 V overvoltage protection
	Earth (ground) terminal	<b>CAT IV 600 V</b>	Category IV 600 V overvoltage protection
	Equipment protected throughout by double insulation or reinforced insulation		Do not use in distribution systems with voltages higher than 600 V

## Safety Considerations

Read the information below before using this tester. The descriptions and instructions in this manual apply to the Keysight U1461A Insulation Multimeter and the U1453A Insulation Tester.

Model U1461A appears in all illustrations. The word *tester* is used to represent both models.

### WARNING

- Do not exceed any of the measurement limits defined in the specifications to avoid instrument damage and the risk of electric shock.
- Do not use the tester if it is damaged. Before you use the tester, inspect the case. Look for cracks or missing plastic. Pay particular attention to the insulation surrounding the connectors.
- Inspect the test leads for damaged insulation or exposed metal. Check the test leads for continuity. Replace damaged test leads before you use the tester.
- Do not operate the tester around explosive gas, vapor, or wet environments.
- Do not apply more than the rated voltage (as marked on the tester) between terminals, or between terminal and earth ground.
- Before use, verify the tester's operation by measuring a known voltage.
- When servicing the tester, use only the specified replacement parts.
- Use caution when working above 60 VDC, 30 VAC RMS, or 42.4 V peak. Such voltages pose a shock hazard.
- When using the probes, keep your fingers behind the finger guards on the probes.
- Connect the common test lead before you connect the live test lead. When you disconnect the leads, disconnect the live test lead first.
- Remove the test leads from the tester before you open the battery cover.
- Do not operate the tester with the battery cover or portions of the cover removed or loosened.
- To avoid false readings, which may lead to possible electric shock or personal injury, replace the battery as soon as the low battery indicator appears and flashes.

**WARNING**

- Ensure that you do not perform insulation resistance tests in distribution systems with voltages higher than 600 V.
- For insulation resistance tests, ensure that you select a suitable test voltage for the equipment to be tested.

For model U1461A only:

- When measuring current, turn off the circuit power before connecting the tester in the circuit. Remember to place the tester in series with the circuit.
  - Be aware of the presence of hazardous voltage before using the Low Pass Filter (LPF) function for voltage measurement. Voltages measured are usually greater than the values indicated on the tester as the voltages with higher frequencies have been filtered through the LPF function.
- 

**CAUTION**

- Disconnect circuit power and discharge all high-voltage capacitors before testing resistance, continuity, diodes, or capacitance.
- Use the proper terminals, function, and range for your measurements.
- This device is for use at altitudes of up to 2,000 m.
- Always use the specified battery type. The power for the tester is supplied with four 1.5 V AA batteries. Observe the correct polarity markings before you insert the batteries to ensure proper insertion of the batteries in the tester.

For model U1461A only:

- Never measure voltage when current measurement is selected.
-

## Measurement Category

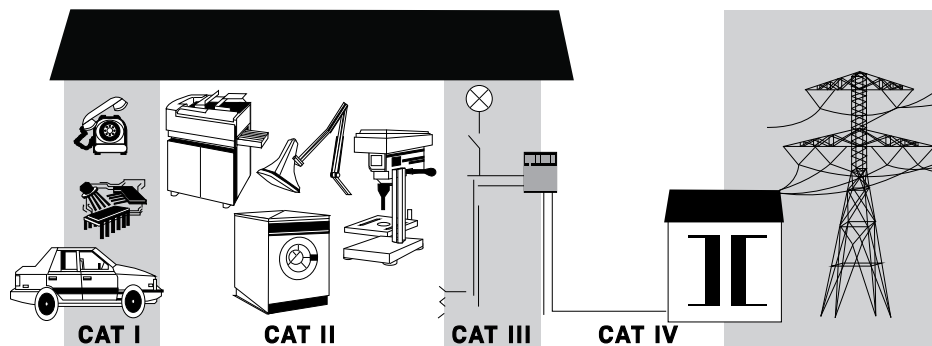
The Keysight U1461A/U1453A tester has a safety rating of CAT III, 1000 V and CAT IV, 600 V.

**Measurement CAT I** Measurements performed on circuits not directly connected to the AC mains. Examples are measurements on circuits not derived from the AC mains and specially protected (internal) mains-derived circuits.

**Measurement CAT II** Measurements performed on circuits directly connected to a low-voltage installation. Examples are measurements on household appliances, portable tools, and similar equipment.

**Measurement CAT III** Measurements performed in the building installation. Examples are measurements on distribution boards, circuit-breakers, wiring, including cables, bus-bars, junction boxes, switches, socket outlets in the fixed installation, and equipment for industrial use, and some other equipment including stationary motors with permanent connection to the fixed installation.

**Measurement CAT IV** Measurements performed at the source of the low-voltage installation. Examples are electricity meters and measurements on primary overcurrent protection devices and ripple control units.



## Environmental Conditions

This instrument is designed for indoor use and in an area with low condensation. The table below shows the general environmental requirements for this instrument.

Environmental condition	Requirement
Temperature	Operating condition
	– –40 °C to 55 °C, 0% to 80% RH (using lithium batteries), >1 hour operating time <sup>[a]</sup>
	– –20 °C to 55 °C, 0% to 80% RH (using alkaline batteries), 20 minutes operating time <sup>[a]</sup>
Humidity	Storage condition
	– –40 °C to 70 °C, 0% to 80% RH (without batteries)
Humidity	Full accuracy up to 80% RH for temperatures up to 30 °C, decreasing linearly to 50% RH at 55 °C
Altitude	Up to 2,000 meters
Pollution degree	Pollution degree II






[a] The operating time is defined when the tester stays at a temperature of 20 °C, and then it is moved to colder environment of –40 °C for short period of time. The operating temperature of the battery should be allowed from –20 °C or –40 °C. You should monitor the ambient temperature sensed by the tester. The tester is operational if the temperature display is not less than –20 °C or –40 °C, according to battery type.

### NOTE

The U1461A Insulation Multimeter and U1453A Insulation Tester complies with the following safety and EMC requirements:

- Safety compliance
  - Designed in compliance to IEC/EN 61010-1:2010 for Category III 1000 V and Category IV 600 V
  - Designed in compliance to IEC/EN 61557-1, IEC/EN 61557-2, and IEC/EN 61557-4
- EMC compliance
  - Commercial limits compliance with IEC 61326-1:2005/EN 61326-1:2006

## Regulatory Markings

 <p>The CE mark is a registered trademark of the European Community. This CE mark shows that the product complies with all the relevant European Legal Directives.</p>	 <p>The RCM mark is a registered trademark of the Spectrum Management Agency of Australia. This signifies compliance with the Australia EMC Framework regulations under the terms of the Radio Communication Act of 1992.</p>
<p><b>ICES/NMB-001</b></p> <p>ICES/NMB-001 indicates that this ISM device complies with the Canadian ICES-001. Cet appareil ISM est conforme a la norme NMB-001 du Canada.</p>	 <p>This instrument complies with the WEEE Directive (2002/96/EC) marking requirement. This affixed product label indicates that you must not discard this electrical or electronic product in domestic household waste.</p>
 <p>The CSA mark is a registered trademark of the Canadian Standards Association.</p>	 <p>This symbol indicates the time period during which no hazardous or toxic substance elements are expected to leak or deteriorate during normal use. Forty years is the expected useful life of the product.</p>



## Waste Electrical and Electronic Equipment (WEEE) Directive 2002/96/EC

This instrument complies with the WEEE Directive (2002/96/EC) marking requirement. This affixed product label indicates that you must not discard this electrical or electronic product in domestic household waste.

### Product category:

With reference to the equipment types in the WEEE directive Annex 1, this instrument is classified as a “Monitoring and Control Instrument” product.

The affixed product label is as shown below.



Do not dispose in domestic household waste.

THIS PAGE HAS BEEN INTENTIONALLY LEFT BLANK.

# Table of Contents

Safety Symbols	3
Safety Considerations	4
Measurement Category	6
Environmental Conditions	7
Regulatory Markings	8
Waste Electrical and Electronic Equipment (WEEE) Directive 2002/96/EC	9
Product category:	9
Sales and Technical Support	9
<b>1 Introduction</b>	
About This Manual	20
Documentation map	20
Safety notes	20
Preparing Your Tester	21
Check the shipment	21
Install or change the batteries	21
Turn on your tester	24
Select the range	24
Adjust the tilt stand	25
Connect to the Handheld Meter Logger Software	26
Connect the Bluetooth adapter	27
Your Tester in Brief	28
Dimensions	28
Overview	30
Rotary switch	32
Keypad	35
Display screen	39
Input terminals	47
Cleaning Your Tester	48
Additional Features	49

Automatic power-off	49
OLED Auto Dim function	49
Change the OLED brightness	49
Hazardous voltage indication	50
Power-on options	50

## 2 Making Measurements

Insulation Resistance Test	52
Using the Remote Switch Probe	54
Locking the test	55
Timed (T) insulation resistance/earth-bond resistance test	56
Measuring the Dielectric Absorption Ratio (DAR)	57
Measuring the Polarization Index (PI)	58
Viewing the leakage current	59
Performing leakage current trip tests	59
Performing stepped voltage trip tests	61
Changing the insulation resistance test voltage	66
Earth-Bond Resistance Test	67
Measuring AC or DC Voltage	70
Auto AC or DC signal identification	72
Using the LPF (Low Pass Filter) feature for AC signals	73
Enabling the LPF in the Setup	75
Measuring AC or DC Current	76
% Scale of 4-20 mA or 0-20 mA	78
Measuring Frequency	79
Measuring duty cycle and pulse width	81
Measuring Resistance	82
Continuity Test	84
Diode Test	86
Using the Auto-diode feature	89
Measuring Capacitance	91
Viewing the cable length value	93
Measuring Temperature	94

<b>3</b>	<b>Tester Features</b>	
	Non-Contact AC Voltage Detection (Vsense)	100
	Making Relative Measurements (Null)	102
	Capturing Maximum and Minimum Values (Max Min)	103
	Freezing the Display (TrigHold and AutoHold)	105
	Performing Limit Comparisons (Limit)	106
	Recording Measurement Data (Log)	108
	Performing manual logs (HAND)	109
	Performing interval logs (AUTO)	109
	Performing event logs (TRIG)	110
	Reviewing Previously Recorded Data (View)	113
<b>4</b>	<b>Setup Options</b>	
	Using the Setup Menu	116
	Editing numerical values	117
	Setup Menu Summary	118
	Setup Menu Items	125
	Menu 1	125
	Menu 2	129
	Menu 3	131
	Menu 4	135
	Menu 5	139
	Menu 6	141
	Menu 7	145
	Menu 8	149
	Menu 9	150
	Menu 10	154
	Menu 11	158
<b>5</b>	<b>Characteristics and Specifications</b>	

THIS PAGE HAS BEEN INTENTIONALLY LEFT BLANK.

## List of Figures

Figure 1-1	Keysight Handheld Meter Logger Software	26
Figure 1-2	Bluetooth adapter connection	27
Figure 1-3	Width dimensions	28
Figure 1-4	Height and depth dimensions	29
Figure 1-5	Display screen allocation example	39
Figure 1-6	Analog bar graph example	45
Figure 1-7	Connecting the remote switch probe	47
Figure 2-1	Insulation resistance test example	53
Figure 2-2	T operation	56
Figure 2-3	DAR operation	57
Figure 2-4	PI operation	58
Figure 2-5	TRIP operation	60
Figure 2-6	Scan signal	62
Figure 2-7	SCAN TRIP operation	63
Figure 2-8	Ramp signal	64
Figure 2-9	RAMP TRIP operation	65
Figure 2-10	Earth-bond resistance test example	68
Figure 2-11	AC or DC voltage measurement example	71
Figure 2-12	AC voltage with LPF measurement example	73
Figure 2-13	Enabling the low-pass filter	75
Figure 2-14	AC or DC current measurement example	77
Figure 2-15	Definition of frequency	80
Figure 2-16	Resistance measurement example	83
Figure 2-17	Continuity test example	85
Figure 2-18	Forward-bias diode test example	87
Figure 2-19	Reverse-bias diode test example	88
Figure 2-20	Auto-diode operation	90
Figure 2-21	Capacitance measurement example	92
Figure 2-22	Surface temperature measurement example	96
Figure 3-1	Detecting AC voltage example	101

THIS PAGE HAS BEEN INTENTIONALLY LEFT BLANK.



## List of Tables

Table 1-1	Front panel part descriptions	30
Table 1-2	Rear panel parts	31
Table 1-3	U1461A/U1453A rotary switch functions	32
Table 1-4	U1461A/U1453A keypad functions	35
Table 1-5	General annunciators	40
Table 1-6	Measurement units display	44
Table 1-7	Analog bar graph display counts/bar	46
Table 1-8	Terminal connections for different measuring functions	47
Table 1-9	Power-on options	50
Table 2-1	Rotary switch position for insulation resistance tests	52
Table 2-2	User test voltage range for insulation resistance	66
Table 2-3	Earth-bond resistance test position	67
Table 2-4	AC and DC voltage measurement positions	70
Table 2-5	AC and DC current measurement positions	76
Table 2-6	% Scale measurement range	78
Table 2-7	Measurement positions allowing frequency measurements	79
Table 2-8	Resistance measurement position	82
Table 2-9	Continuity test position	84
Table 2-10	Diode test position	86
Table 2-11	Auto-diode voltage thresholds	89
Table 2-12	Capacitance measurement position	91
Table 2-13	Temperature measurement position	94
Table 3-1	Hi/Lo default settling values	106
Table 3-2	Log maximum capacity	108
Table 3-3	Event log trigger conditions	111
Table 4-1	Setup menu key functions	116
Table 4-2	Setup menu item descriptions	118

THIS PAGE HAS BEEN INTENTIONALLY LEFT BLANK.

# 1 Introduction

About This Manual	20
Preparing Your Tester	21
Your Tester in Brief	28
Cleaning Your Tester	48
Additional Features	49

This chapter helps you set up your tester for the first time. An introduction to all the features of the tester is also given.

## About This Manual

### Safety notes

The following safety notes are used throughout this manual. More pertinent safety notes for using this product are located under the [Safety Symbols](#) section.

#### CAUTION

Caution denotes a hazard. It calls attention to a procedure that, if not correctly performed or adhered to, could result in damage to or destruction of the product. Do not proceed beyond a caution notice until the indicated conditions are fully understood and met.

---

#### WARNING

Warning denotes a hazard. It calls attention to a procedure which, if not correctly performed or adhered to, could result in injury or loss of life. Do not proceed beyond a warning note until the indicated conditions are fully understood and met.

---

## Preparing Your Tester

### Check the shipment

When you receive your tester, check the shipment according to the following procedure.

- 1** Inspect the shipping container for damage. Signs of damage may include a dented or torn shipping container or cushioning material that indicates signs of unusual stress or compacting. Save the packaging material in case the tester needs to be returned.
- 2** Carefully remove the contents from the shipping container, and verify that the standard accessories and your ordered options are included in the shipment according to the standard shipped items list found in the printed copy of the *U1461A/U1453A Quick Start Guide*.
- 3** For any question or problems, refer to the Keysight contact numbers on the back of this manual.

### Install or change the batteries

Your tester is powered by four 1.5 V AA lithium batteries (included in the shipment). When you receive your tester, the batteries are not installed.

Use the following procedure to install or change the batteries.

#### CAUTION

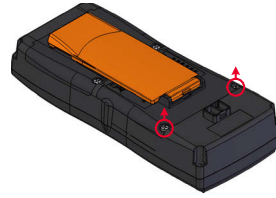
Before you proceed with the batteries installation, remove all cable connections to the terminals and ensure that the rotary switch is at the **OFF** position. Use only the battery type specified in the data sheet.

---

## 1 Introduction

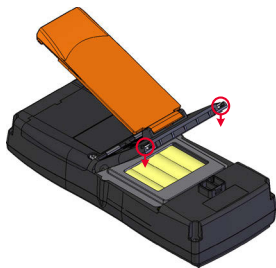
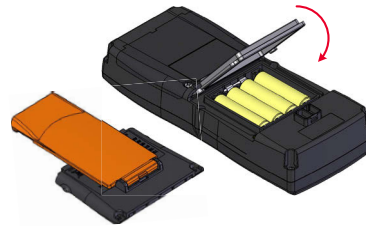
---

- 1 Remove the orange rubber holster. Pull from a top corner and stretch the orange rubber holster off the tester.
- 2 Loosen and remove the two screws with a suitable Phillips screwdriver as shown on the right.



- 3 Lift and remove the battery cover as shown on the left.



- 4 Lift the inner rubber cover to access the battery compartment.
- 5 Observe the proper battery polarity. The terminal ends of each battery are indicated inside the battery compartment. Insert four 1.5 V AA batteries.



- 6 Ensure that the inner rubber cover is positioned properly.
- 7 Replace the battery cover back in its original position and tighten the screws.
- 8 Finally fit the orange rubber holster back on the tester.

The battery level indicator in the upper left-hand corner of the display indicates the relative condition of the batteries.



Replace the batteries as soon as possible when the low battery indicator (  ↔  ) flashes.

### WARNING

To avoid false readings, which could lead to possible electric shock or personal injury, replace the battery as soon as the low battery indicator appears. Do not discharge the battery by shorting the battery or reversing the battery polarity in any of the batteries.

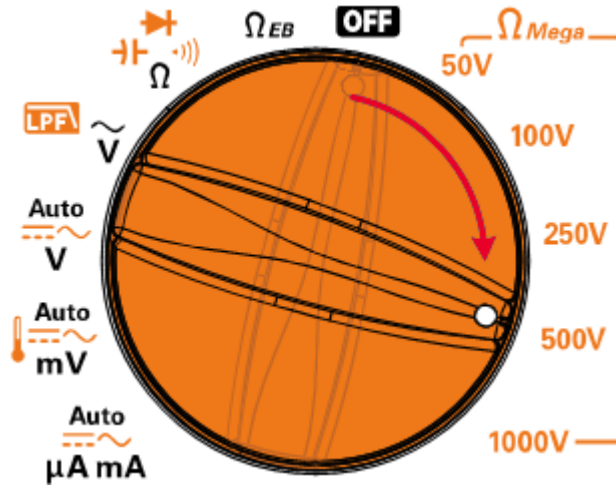
### CAUTION

To avoid testers being damaged from battery leakage:

- Always remove dead batteries immediately.
- Always remove the batteries and store them separately if the tester is not going to be used for a long period.

## Turn on your tester

To power ON your tester, turn the rotary switch from the **OFF** position to any other position.



## Select the range

The tester's selected range is always displayed on the right-hand end of the bar graph.





Pressing **Range** changes the tester range (and disables auto-ranging). Each additional presses of **Range** (in manual ranging) sets the tester to the next higher range, unless it is already in the highest range, at which point the range switches to the lowest range.

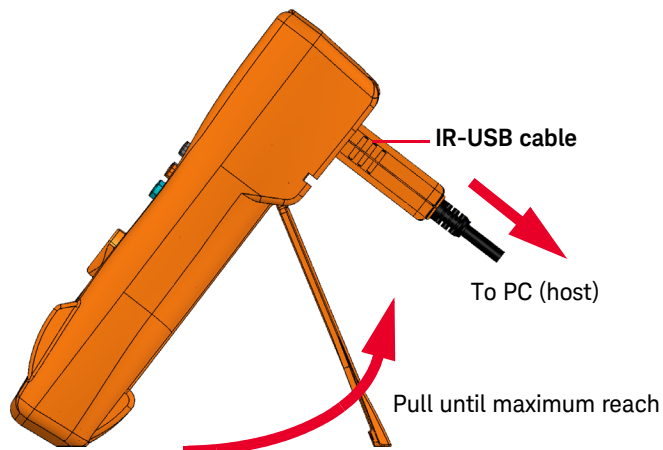
Press and hold **Range** to switch the tester to **auto-ranging**. Auto-ranging is convenient because the tester automatically selects an appropriate range for sensing and displaying each measurement.

## NOTE

- Changing the tester range (and disabling auto-ranging) is not allowed for earth-bond resistance tests and insulation resistance tests.
- The range is fixed for diode tests and temperature measurements.
- In auto-range, the tester selects the lowest range to display the highest available precision (resolution) for the input signal.
- If a reading is greater than maximum available range, **OL** (overload) is shown on the display – except for earth-bond resistance tests and insulation resistance tests where to indicate maximum reading, **>** is shown on the display instead.

## Adjust the tilt stand

To adjust the tester to a 60° standing position, pull the tilt-stand outward to its maximum reach.

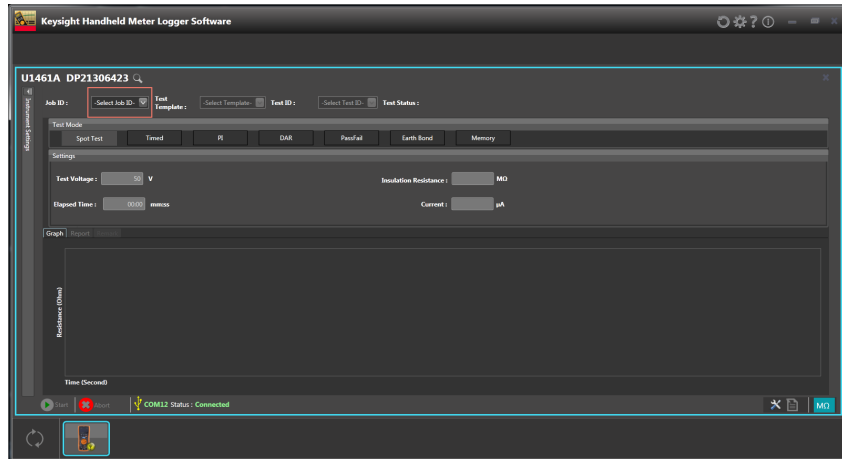


## Connect to the Handheld Meter Logger Software

You can use the IR communication link (IR communication port, located at the rear panel) and the Keysight Handheld Meter Logger Software to control your tester remotely, perform data logging operations, and transfer the contents of your tester's memory to a PC.

Ensure that the Keysight logo on the U1173A IR-USB cable connected to the tester is facing up. Firmly push the IR head into the tester's IR communication port until it snaps into place.

Refer to the *Keysight Handheld Meter Logger Software Help* and *Quick Start Guide* for more information on the IR communication link and the Keysight Handheld Meter Logger Software.



**Figure 1-1** Keysight Handheld Meter Logger Software

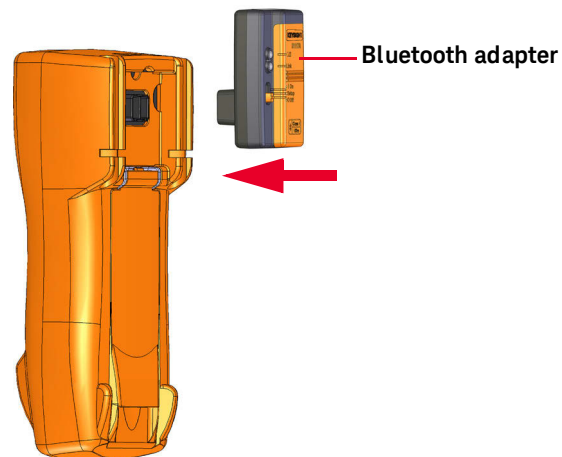
## Connect the Bluetooth adapter

The U1117A Infrared (IR)-to-**Bluetooth**<sup>®</sup> adapter allows you to connect the tester wirelessly to any Windows PC, Android device, or iOS device.

The U1117A is compatible with the following application or software:

- Keysight Handheld Meter Logger (for Windows PC)
- Keysight Mobile Meter (for Android or iOS devices)
- Keysight Mobile Logger (for Android or iOS devices)

Snap the optic side of the U1117A to the tester's IR communication port (see [Figure 1-2](#)).



**Figure 1-2** Bluetooth adapter connection

## Your Tester in Brief

### Dimensions

Front view



Figure 1-3 Width dimensions

Rear and side view

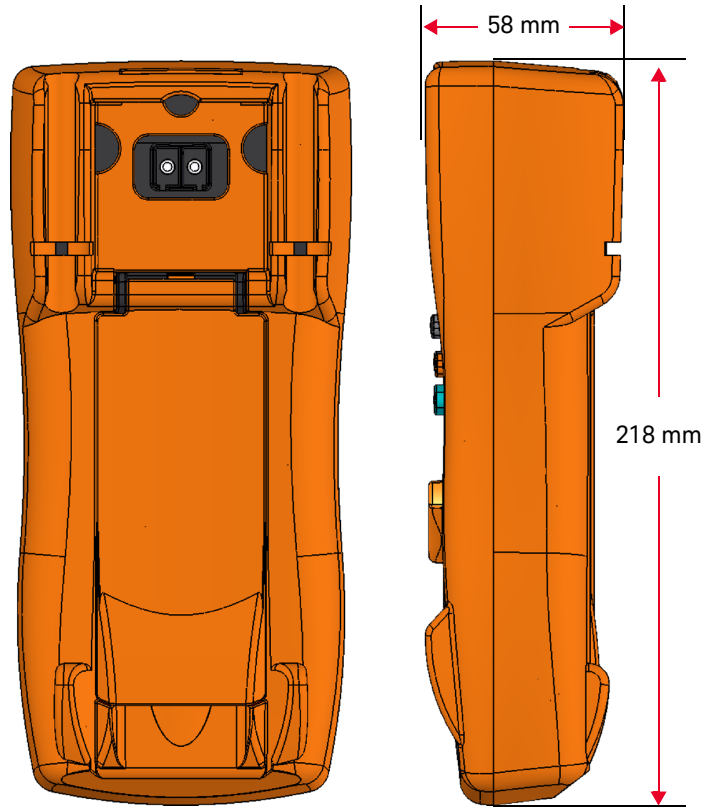
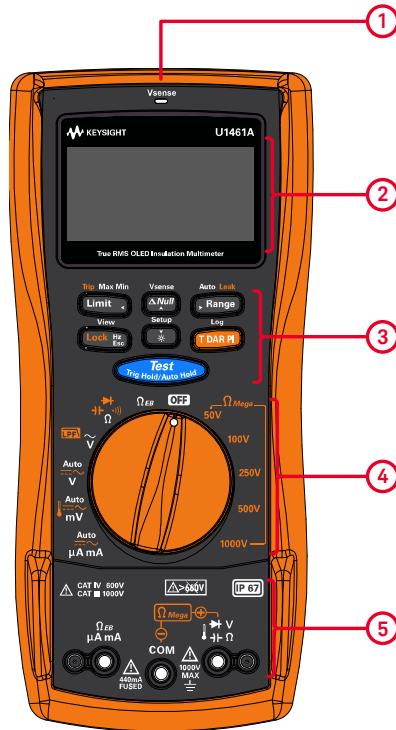


Figure 1-4 Height and depth dimensions

## Overview

### Front panel

The front panel parts of your tester are described in this section.

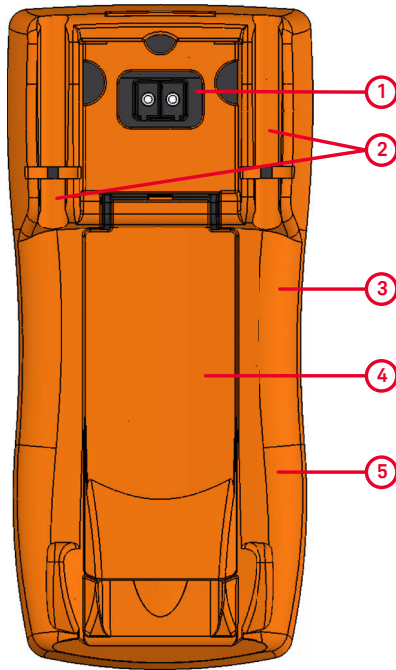


**Table 1-1** Front panel part descriptions

Legend	Description	Learn more on:
1	Vsense detector (model U1461A only)/Red LED indicator	<a href="#">page 100</a>
2	Display screen	<a href="#">page 39</a>
3	Keypad	<a href="#">page 35</a>
4	Rotary switch	<a href="#">page 32</a>
5	Input terminals	<a href="#">page 47</a>

## Rear panel

The rear panel parts of your tester are described in this section.



**Table 1-2** Rear panel parts

Legend	Description	Learn more on:
1	IR communication port	<a href="#">page 26</a>
2	Test lead/probe holders	-
3	Battery access (under the orange rubber holster)	<a href="#">page 21</a>
4	Tilt stand	<a href="#">page 25</a>
5	Fuse access (under the orange rubber holster)	-

## Rotary switch

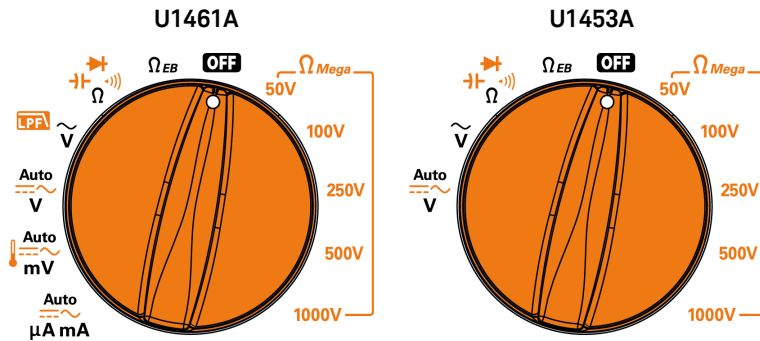
The measurement functions for each rotary switch position are described in [Table 1-3](#). Turning the rotary switch changes the measurement function and resets all other measurement options.

### WARNING

Remove the test leads from the measuring source or target before changing the rotary switch position.

### NOTE

Press **T D A R P I** to select the alternate measurement function(s) or test methods for insulation resistance tests. See [page 35](#) for more information on the **T D A R P I** key.









**Table 1-3** U1461A/U1453A rotary switch functions






Legend	Measurement function	U1461A	U1453A	Learn more on:
	50 V Insulation resistance test	✓	✓	
$\Omega$ Mega 50V	T - Timed test	✓	✓	page 67
	DAR - Dielectric Absorption Ratio test	✓	✓	
	PI - Polarization Index Test	✓	✓	



**Table 1-3** U1461A/U1453A rotary switch functions (continued)

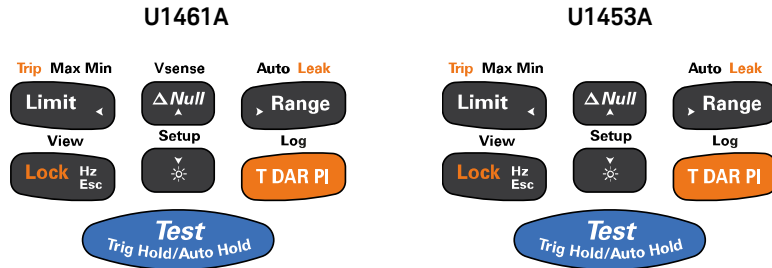
Legend	Measurement function	U1461A	U1453A	Learn more on:
	100 V Insulation resistance test	✓	✓	page 67
	T - Timed test	✓	✓	
	DAR - Dielectric Absorption Ratio test	✓	✓	
	PI - Polarization Index Test	✓	✓	
	250 V Insulation resistance test	✓	✓	page 67
	T - Timed test	✓	✓	
	DAR - Dielectric Absorption Ratio test	✓	✓	
	PI - Polarization Index Test	✓	✓	
	500 V Insulation resistance test	✓	✓	page 67
	T - Timed test	✓	✓	
	DAR - Dielectric Absorption Ratio test	✓	✓	
	PI - Polarization Index Test	✓	✓	
	1000 V Insulation resistance test	✓	✓	page 67
	T - Timed test	✓	✓	
	DAR - Dielectric Absorption Ratio test	✓	✓	
	PI - Polarization Index Test	✓	✓	
	Earth-bond resistance test	✓	✓	page 67
	T - Timed test	✓	✓	
	Resistance measurement	✓	✓	page 82
	Continuity test	✓	✓	page 84
	Diode test	✓	✓	page 86
	Capacitance measurement	✓	✓	page 91

**Table 1-3** U1461A/U1453A rotary switch functions (continued)









Legend	Measurement function	U1461A	U1453A	Learn more on:
 	AC voltage measurement	✓	✓	<a href="#">page 52</a>
	AC voltage measurement with Low Pass Filter (LPF)	✓	-	<a href="#">page 73</a>
	Auto voltage measurement	✓	✓	
	DC voltage measurement	✓	✓	
	AC voltage measurement	✓	✓	<a href="#">page 52</a>
	Auto voltage measurement (mV)	✓	-	
	DC voltage measurement (mV)	✓	-	
	AC voltage measurement (mV)	✓	-	
	Temperature measurement	✓	-	<a href="#">page 94</a>
	Auto current measurement (μA mA)	✓	-	
	DC current measurement (mA mA)	✓	-	
	AC current measurement (mA mA)	✓	-	<a href="#">page 76</a>
	% Scale of 4-20 mA	✓	-	

## Keypad





















The operation of each key is explained in Table 1-4 below. Pressing a key enables a function, displays a related symbol, and emits a beep. Turning the rotary switch to another position resets the current operation of the key.



**Table 1-4** U1461A/U1453A keypad functions

Legend	Function when pressed for:	
	Less than 1 second	More than 1 second
	<p><b>Insulation Resistance (IR) Test:</b> Initiates an IR test (when the rotary switch is in one of the <math>\Omega</math> Mega positions) as long as  is held – the tester sources (outputs) a high voltage and measures insulation resistance and  is shown on the display.</p>	
	<p><b>Earth-Bond Resistance (EBR) Test:</b> Initiates an EBR test (when the rotary switch is in the <math>\Omega</math> EB position) as long as  is held – the tester measures earth-bond resistance and  is shown on the display.</p>	
	<p><b>Trig Hold:</b> Freezes the present reading in the display (except when the rotary switch is in one of the <math>\Omega</math> Mega positions or in the <math>\Omega</math> EB position).</p> <ul style="list-style-type: none"> <li>– In TrigHold mode, press  to manually trigger the holding of the next measured value.</li> <li>– Press and hold  again to exit this mode.</li> </ul>	<p><b>Auto Hold:</b> Automatically freezes the present reading once the reading is stable (except when the rotary switch is in one of the <math>\Omega</math> Mega positions or in the <math>\Omega</math> EB position).</p> <ul style="list-style-type: none"> <li>– In AutoHold mode, the reading is updated automatically once the reading is stable and the count setting is exceeded.</li> <li>– Press and hold  again to exit this mode.</li> </ul>



























**Table 1-4** U1461A/U1453A keypad functions (continued)

Legend	Function when pressed for:	
	Less than 1 second	More than 1 second
	<p><b>Lock:</b> Press  to lock the insulation test or earth-bond resistance test (when the rotary switch is in the appropriate position).</p> <ul style="list-style-type: none"> <li>– Press  &gt;  to initiate an IR or EBR test. The test remains active until you press  or  again to release the lock.</li> <li>– Press  during capacitance measurements to view the cable length of the circuit under test.</li> </ul>	<p><b>View:</b> Press and hold  to enter the Log Review menu.</p> <ul style="list-style-type: none"> <li>– Press  to cycle through the previously recorded manual (<b>VIEW H</b>), interval (<b>VIEW A</b>), or event (<b>VIEW E</b>) logging data.</li> <li>– Press  or  to view first or last logged data respectively.</li> <li>– Press  or  to scroll through the logged data.</li> <li>– Press  to delete the last logged data.</li> <li>– Press and hold  to clear all the logged data for the selected logging mode.</li> <li>– Press and hold  again to exit this mode.</li> </ul>
	<p><b>Hz:</b> Press  to display the frequency for voltage or current measurements.</p> <ul style="list-style-type: none"> <li>– <b>Model U1461A only:</b> Press  again to scroll through the frequency (<b>Hz</b>), pulse width (<b>ms</b>), and duty cycle (<b>%</b>) measurements. This option must first be enabled in the Setup menu (see <a href="#">page 157</a>).</li> <li>– Press  again to disable the frequency display.</li> </ul> <p><b>Esc:</b> Press  in the Setup menu to discard your changes.</p>	

**Table 1-4** U1461A/U1453A keypad functions (continued)

Legend	Function when pressed for:	
	Less than 1 second	More than 1 second
	<p>Press  to switch or cycle between the default and <b>alternate</b> measurement function(s).</p>	<p><b>Log:</b> The recording option (HAND, AUTO, or TRIG) must first be selected in the Setup menu (see <a href="#">page 126</a>).</p> <ul style="list-style-type: none"> <li>– <b>HAND</b> (manual data logging) – Press and hold  to log the present reading into the memory. The display will return to normal after a short while (<math>\approx</math> 1 second). To manually log another reading, press and hold  again.</li> <li>– <b>AUTO</b> (automatic data logging) – Press and hold  to enable the automatic data logging mode, where data is logged at the interval defined in the Setup menu (see <a href="#">page 126</a>). Press and hold  again to exit this mode.</li> <li>– <b>TRIG</b> (event data logging) – Press and hold  to enable the event data logging mode, where data is logged each time a triggering condition is satisfied (see <a href="#">page 112</a>). Press and hold  again to exit this mode.</li> </ul>
	<p><b>T:</b> Configures the tester for a timed test (when the rotary switch is in one of the <math>\Omega</math> <b>Mega</b> positions or the <math>\Omega</math> <b>EB</b> position).</p> <p>The test will start when you press .</p>	
	<p><b>DAR:</b> Configures the tester for a dielectric absorption ratio test (when the rotary switch is in one of the <math>\Omega</math> <b>Mega</b> positions).</p> <p>The test will start when you press .</p>	
	<p><b>PI:</b> Configures the tester for a polarization index test (when the rotary switch is in one of the <math>\Omega</math> <b>Mega</b> positions).</p> <p>The test will start when you press .</p>	
	<p><b>Limit:</b> Press  to enable the comparison for limit mode.</p> <ul style="list-style-type: none"> <li>– Press  again to set the comparison value. Use the arrow keys (<a href="#">page 116</a>) to change the value shown and press  to save your changes.</li> <li>– Press and hold  to exit this mode.</li> </ul>	
<p><b>Trip Max Min</b></p> 	<p><b>Trip:</b> When the rotary switch is in one of the <math>\Omega</math> <b>Mega</b> positions, first press  to display the leakage current.</p> <p>Then, press  to cycle through the various Trip tests for insulation resistance measurement.</p> <p>The test will start when you press .</p> <ul style="list-style-type: none"> <li>– Trip by leakage current</li> <li>– Trip by stepped voltage (Scan)</li> <li>– Trip by stepped voltage (Ramp)</li> </ul>	
		<p><b>Max Min:</b> Press and hold  to start the Max Min recording.</p> <ul style="list-style-type: none"> <li>– Press  again to cycle through maximum (<b>REC MAX</b>), minimum (<b>REC MIN</b>), average (<b>REC AVG</b>), and present (<b>REC NOW</b>) readings.</li> <li>– Press and hold  again to exit this mode.</li> <li>– Max Min is disabled when Trip tests are enabled.</li> </ul>

**Table 1-4** U1461A/U1453A keypad functions (continued)

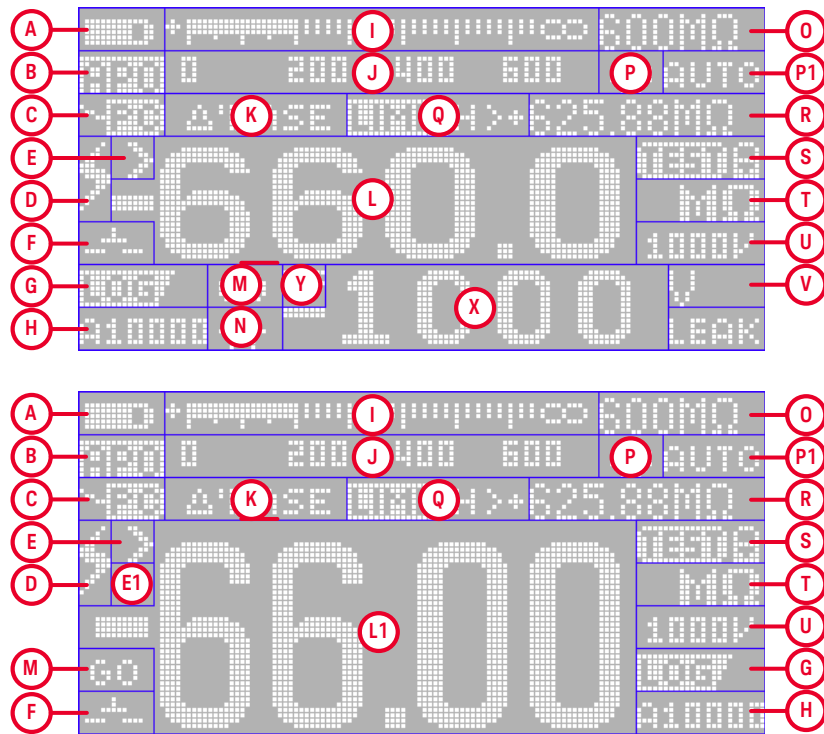
Legend	Function when pressed for:	
	Less than 1 second	More than 1 second
<p><b>Auto Leak</b></p> 	<p><b>Range:</b> Press  to set a manual range and disable auto-ranging.</p> <ul style="list-style-type: none"> <li>Press  again to cycle through each available measurement range.</li> <li>Press  during temperature measurements to change the temperature measurement unit between Celsius (°C) and Fahrenheit (°F). This option must first be enabled in the Setup menu (see <a href="#">page 155</a>).</li> </ul> <p><b>Leak:</b> Press  to display the leakage current.</p>	<p><b>Auto:</b> Press and hold  to enable auto-ranging.</p> <hr/> <p><b>Auto:</b> Press and hold  during diode tests to enable the Auto-diode feature. Press and hold  again to exit this mode.</p>
<p><b>Vsense</b></p> 	<p><b>Null:</b> Press  to enable the relative function.</p> <ul style="list-style-type: none"> <li>The displayed value is saved as a reference to be subtracted from subsequent measurements.</li> <li>Press  again to view the stored reference value that has been saved. The display will return to normal after a brief period of time (approx. 3 seconds).</li> <li>Pressing  while the stored reference value is being displayed will cancel the relative function.</li> </ul>	<p><b>Vsense (model U1461A only):</b> Press and hold  to enable the non-contact voltage presence indicator.</p> <ul style="list-style-type: none"> <li>Press  to change the Vsense detector's sensitivity from <b>HIGH SENSE</b> to <b>LOW SENSE</b>.</li> <li>Press and hold  again to exit this mode.</li> </ul>
<p><b>Setup</b></p> 	<p><b>*</b>: Press  to increase or decrease the OLED brightness. This option must first be enabled in the Setup menu (see <a href="#">page 132</a>).</p>	<p><b>Setup:</b> Press and hold  to enter the Setup menu.</p> <ul style="list-style-type: none"> <li>In the Setup menu, press  or  to navigate through the menu pages. Press  or  at each menu page to move the cursor to a specific menu item.</li> <li>Press  to change the value of the selected menu item. Use the arrow keys (<a href="#">page 116</a>) to change the value shown.</li> <li>Press  again to save your changes, or press  to discard your changes.</li> <li>Press and hold  again to exit the Setup menu.</li> </ul>

## Display screen

The display annunciators of your tester are described in this section. See also “[Measurement units](#)” on page 44 for a list of available measurement signs and notations and “[Analog bar graph](#)” on page 45 for a tutorial on the analog bar graph located at the bottom of your display screen.














### General display annunciators

The general display annunciators of your tester are described in the [Table 1-5](#).





**Figure 1-5** Display screen allocation example

**Table 1-5** General annunciators














Area	Legend	Description
A		Battery capacity indication
B		APO (Auto Power-Off) enabled
C		Remote control enabled
D		Hazardous voltage sign for measuring voltage $\geq 30$ V or OL (overload)
E		Greater than range (for insulation resistance and earth-bond resistance tests)
		Type-J/Type-K thermocouple selected
E1		Polarity (for dual displays)
		- Capacitor is charging (during capacitance measurement) - Positive slope for pulse width ( <b>ms</b> ) and duty cycle (%) measurements
		- Capacitor is discharging (during capacitance measurement) - Negative slope for pulse width ( <b>ms</b> ) and duty cycle (%) measurements
F		Short continuity indication
		Open continuity indication
		Data logging in progress
		View mode for reviewing previously logged data















**Table 1-5** General annunciators (continued)

Area	Legend	Description
H	A:Full A:Paid H001 H100 A1000 E1000	Index for AUTO (automatic), HAND (manual), and TRIG (event) data logging
I		Analog bar graph
J		Scale of analog bar graph
K	ΔNULL Δ'BASE	Relative (Null) enabled Relative value when Null is enabled
L	-660.0	Primary measurement display (medium)
L1	-66.00	Primary measurement display (large)
M	GO NG HI LO	Comparison result for Limit mode
N		Reverse diode indication for Auto-diode test
O	1000mV 600MΩ	Range indication
P		Smooth mode enabled
P1	AUTO	Auto-ranging enabled, Auto-diode enabled, or Auto signal indicator enabled


**Table 1-5** General annunciators (continued)

Area	Legend	Description	
		Maximum reading shown on primary display	
		Minimum reading shown on primary display	
		Averaged reading shown on primary display	
		Present reading shown on primary display	
Q		Auto hold enabled	
		Trigger hold enabled	
		Timed test enabled	
		Dielectric Absorption Ratio test enabled	
		Polarization Index test enabled	
		Limit comparison enabled	
		Overcurrent indication	
		Trip enabled	
		-40.0°C	Ambient temperature indication
	R	99999ε	Elapsed time for Recording mode
	00:59	Timer display for T, DAR, and PI tests	
R+S	 H>>625.88MΩ	Limit value indication for comparison	

**Table 1-5** General annunciators (continued)

Area	Legend	Description
		AC, DC, and AC+DC indication for primary display
S		Low-pass filter enabled for AC measurement
		Diode test enabled
		Temperature measurement without ambient compensation selected
		Test and Test Lock indication for insulation resistance and earth-bond resistance tests
T		Measuring units for primary display
		Test voltage for insulation resistance
		% Scale of 4-20 mA or 0-20 mA
U		Audible continuity test selected
		Audible disabled
		Tone enabled
V		Measuring units for secondary display

**Table 1-5** General annunciators (continued)

Area	Legend	Description
X	<b>-66.00</b>	Secondary measurement display
Y		AC, DC, and AC+DC indication for secondary display

### Measurement units

The available signs and notations for each measurement function in your tester are described in [Table 1-6](#). The units listed below are applicable to the primary display and secondary display measurements of your tester.

**Table 1-6** Measurement units display

Sign/Notation	Description
T	Tera 1E+12 (1000000000000)
G	Giga 1E+09 (1000000000)
M	Mega 1E+06 (1000000)
k	kilo 1E+03 (1000)
n	nano 1E-09 (0.000000001)
μ	micro 1E-06 (0.000001)
m	milli 1E-03 (0.001)
mV, V	Voltage, units for voltage measurement
A, mA, μA, nA	Ampere, units for current measurement
nF, μF, mF	Farad, units for capacitance measurement
Ω, kΩ, MΩ, GΩ,	Ohm, units for resistance measurement
kHz, Hz	Hertz, units for frequency measurement
ms	Millisecond, unit for pulse width measurement

**Table 1-6** Measurement units display (continued)

Sign/Notation	Description
%	Percent, unit for duty cycle measurement
°C	Degree Celsius, unit for temperature measurement
°F	Degree Fahrenheit, unit for temperature measurement
m, km	Meter, units for length
ft	Feet, unit for length
s	Seconds, unit for Recording mode elapsed time

### Analog bar graph

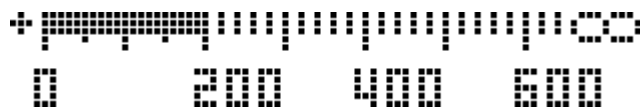
The analog bar emulates the needle on an analog tester, without displaying the overshoot.

#### NOTE

For frequency, duty cycle, pulse width, 4-20 mA % scale, 0-20 mA % scale, and temperature measurements, the bar graph does not represent the primary display value.

For example, when frequency, duty cycle, or pulse width is displayed on the primary display during voltage or current measurement, the bar graph represents the voltage or current value (not the frequency, duty cycle, or pulse width value). Another example is when 4-20 mA % scale or 0-20 mA % scale is displayed on the primary display, the bar graph represents the current value and not the percentage value.

The “+” or “-” sign indicates whether the measured or calculated value is positive or negative. Each bar represents 10 to 100 counts depending on the display count and range selected.



**Figure 1-6** Analog bar graph example

See [Table 1-7](#) for the relevant display counts, span, and counts per bar.

**Table 1-7** Analog bar graph display counts/bar

Display counts	Span 1	Counts/bar	Span 2	Counts/bar
6000	0 to 200	10	>200	20
1000	0 to 200	10	>200	40
2000	0 to 400	20	>400	80


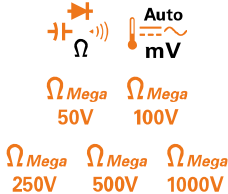
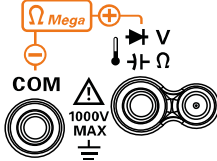

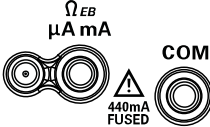
## Input terminals

**WARNING**

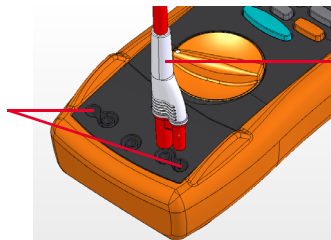
To avoid damaging this device, do not exceed the input limit.

The terminal connections for the different measurement functions of your tester are described in the table below.

**Table 1-8** Terminal connections for different measuring functions

Rotary switch position	Input terminals	Overload protection
		1000 Vrms
		1000 Vrms for short circuit <0.3 A
		440 mA/1000 V, 30 kA fast-acting fuse

Remote switch probe terminal for IR and EBR tests



The remote switch probe is used for insulation resistance (IR) and earth-bond resistance (EBR) tests.

**Figure 1-7** Connecting the remote switch probe

## Cleaning Your Tester

**WARNING**

To avoid electrical shock or damage to the tester, ensure that the insides of the casing stay dry at all times.

---

Dirt or moisture in the terminals can distort readings. Follow the steps below to clean your tester.

- 1 Turn the tester off, and remove the test leads.
- 2 Turn the tester over, and shake out any dirt that may have accumulated in the terminals.

Wipe the case with a damp cloth and mild detergent – do not use abrasives or solvents. Wipe the contacts in each terminal with a clean swab dipped in alcohol.



## Additional Features

### Automatic power-off

Your tester automatically turns off if the rotary switch is not moved or a key is not pressed for 10 minutes (default). Pressing any key will turn the tester back on after it is powered off automatically.

To change the timer period or completely disable the automatic power-off, refer to “[Changing the auto power-off \(APO\) timer](#)” on page 132.

### OLED Auto Dim function


Your tester’s OLED automatically dims if the rotary switch is not moved or a key is not pressed for 90 seconds (default). This auto dim behavior is enabled by default. Pressing any key or changing the rotary switch position will cancel this effect and reset the auto dim timer.


To disable the auto dim, refer to “[Changing the OLED behavior](#)” on page 132.

### Change the OLED brightness

#### NOTE


The auto dim function is enabled by default. Refer to “[Changing the OLED behavior](#)” on page 132 to disable the auto dim function before you can manually change the OLED brightness.

If viewing the display becomes difficult in low-light conditions, press  to change the OLED brightness (this option must first be enabled in the Setup, see “[Changing the OLED behavior](#)” on page 132 for more information).

The **LOW**, **MEDIUM**, or **HIGH** setting must be selected in the tester’s Setup (browse to **Menu 3 > BACKLIT**) prior to this action. Pressing  repeatedly will cycle the OLED brightness from low to medium to high (and back to low again).

You are advised to select a suitable brightness level based on your needs to conserve battery life if you wish to control the OLED brightness level manually.







## Hazardous voltage indication

The tester will display the hazardous voltage () symbol as an early precaution when the measured voltage is equal to or greater than  $\pm$ DC 30 V or AC 30 V, or when the measured voltage is over the measurement range, **OL** (overload).

## Power-on options

Some options can be selected only while you turn the tester on. These power-on options are listed in the table below. To select a power-on option, press and hold the specified key while turning the rotary switch from the **OFF** position to any other position. Power-on options remain selected until the tester is turned off.

**Table 1-9** Power-on options

Key	Description
	Displays the power-on greeting. Press any key to exit this mode.
	Simulates the Auto Power-Off (APO) mode. Press any key to turn the tester back on and resume normal operation.
	Checks firmware version and serial number. The tester's firmware version and serial number will be shown on the primary display. Press any key to exit this mode.
	Toggles the red LED indicator alert for insulation resistance tests. If enabled, the red LED indicator will blink every two seconds during an insulation resistance test. The red LED indicator alert is disabled when the Limit feature (see <a href="#">page 106</a> ) is enabled.
	Smooth is enabled until the tester is turned off. To permanently enable Smooth, see " <a href="#">Enabling smooth mode</a> " on page 128.
	Tests the OLED. All OLED pixels are lighted. Use this mode to verify that there are no dead OLED pixels. Press any key to exit this mode.

## 2 Making Measurements







Insulation Resistance Test	52
Earth-Bond Resistance Test	67
Measuring AC or DC Voltage	70
Measuring AC or DC Current	76
Measuring Frequency	79
Measuring Resistance	82
Continuity Test	84
Diode Test	86
Measuring Capacitance	91
Measuring Temperature	94

The following sections describe how to take measurements with your tester.


## Insulation Resistance Test

Set up your tester as shown in [Figure 2-1](#). Set the rotary switch to a test voltage value that does not exceed the maximum voltage limitation of the circuit under test. Ensure that the device-under-test (DUT) is de-energized before performing any resistance measurement.

**Table 2-1** Rotary switch position for insulation resistance tests

Legend	Default function		Function when  is pressed	
	Primary display	Secondary display	Primary display	Secondary display
	50 V insulation resistance test			
	100 V insulation resistance test		<b>1</b> Timed (T) test	
	250 V insulation resistance test	AC+DC V or DC V (during test)	<b>2</b> Dielectric Absorption Ratio (DAR) test	AC+DC V or DC V (during test)
	500 V insulation resistance test		<b>3</b> Polarization Index (PI) test	
	1000 V insulation resistance test			

### CAUTION

- **DO NOT** perform insulation resistance test in distribution systems with voltages higher than 600 V.
- The tester automatically detects if the circuit is energized. If the external voltage is detected to be greater than 30 V (or 50 V or 75 V; depending on selected option in Setup), the test is inhibited. The symbol  is shown on the display when either the external voltage or the test voltage is greater than 30 V. Disconnect the tester and remove the power of the circuit before proceeding.

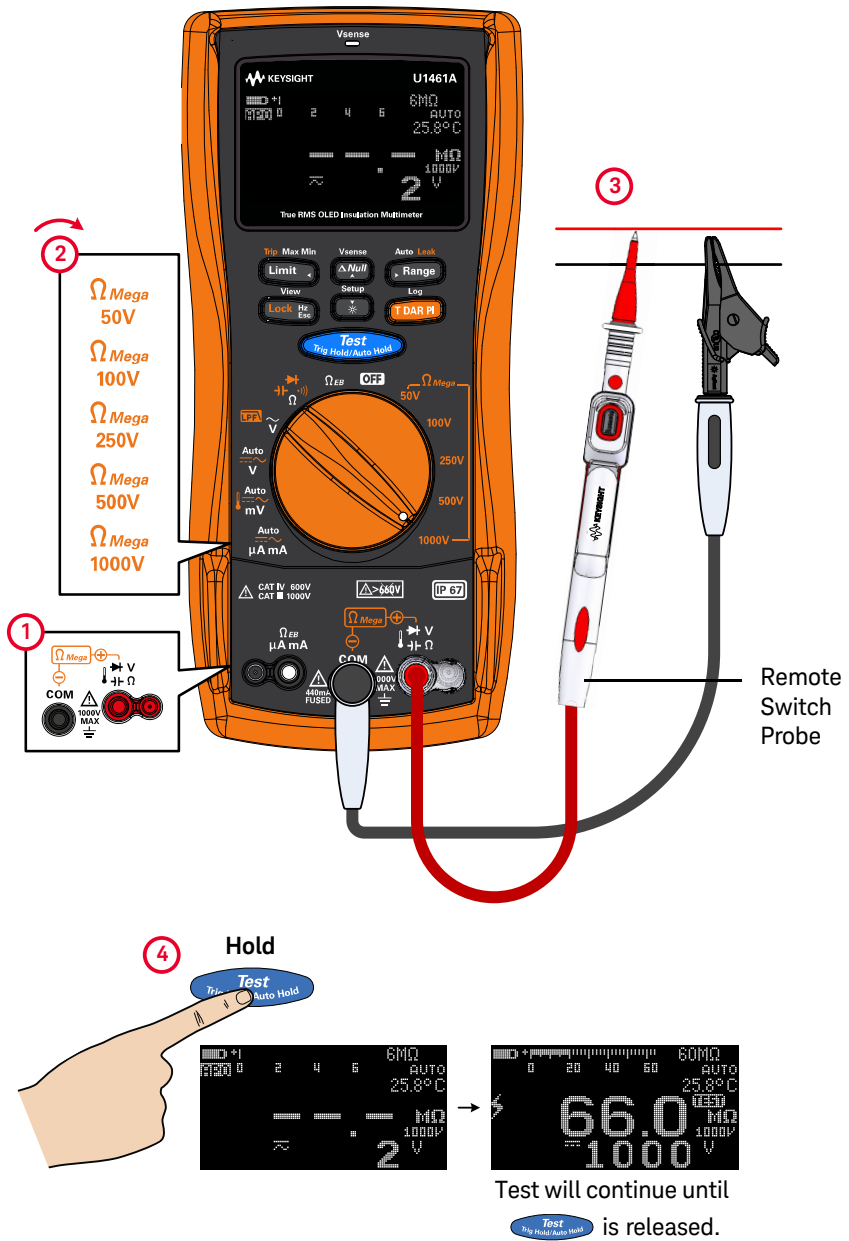


Figure 2-1 Insulation resistance test example

**CAUTION**

The insulation meter will auto-discharge the DUT when the test is complete. However, the DUT will not be auto-discharged when you disconnect the probe before the test is complete. Avoid touching the DUT when the DUT is not fully discharged as it may lead to possible electric shock.

---

**NOTE**

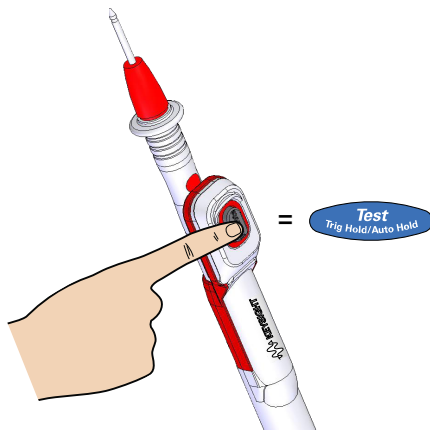
When an insulation test is in progress, the red LED indicator at the top of the tester will blink every 2 seconds (if the Limit function is not enabled). To disable this feature see **“Power-on options”** on page 50.

---

## Using the Remote Switch Probe

The Remote Switch Probe (included in shipment) is used with insulation resistance tests and earth-bond resistance tests, enabling the tester to be controlled remotely from the button on the Remote Switch Probe.


By default the button on the Remote Switch Probe emulates the  button on the tester.

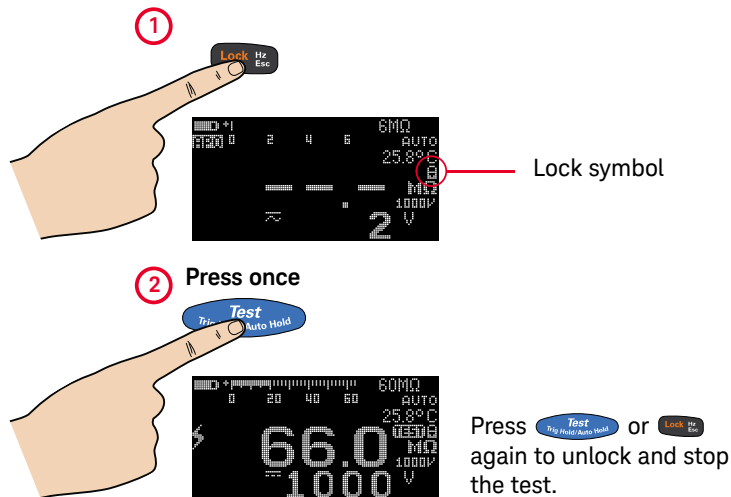


To change the default button operation, see **“Changing the button operation on the remote switch probe”** on page 146.

## Locking the test

You can lock the insulation resistance tests or earth-bond resistance tests temporarily.

Press **Lock Hz Esc** to enable the lock once feature. The  symbol will be shown on the display. The test will start when you press **Test Trip Hold/Auto Hold** and it remains active until **Test Trip Hold/Auto Hold** or **Lock Hz Esc** is pressed again.

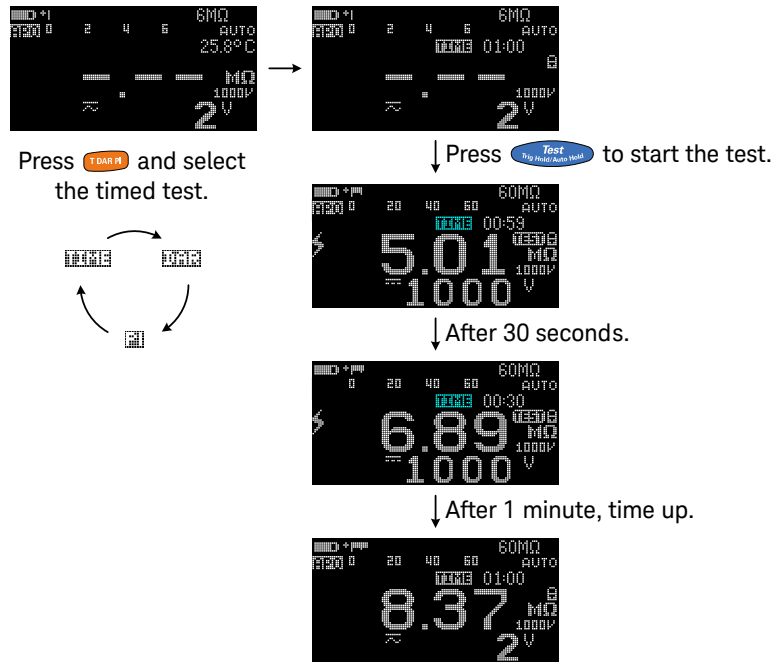


By default, the tester will reset the locked status when the test is stopped by pressing **Test Trip Hold/Auto Hold** or **Lock Hz Esc**. See [“Disabling the lock once feature”](#) on page 147 to disable this feature.

If you disable this feature, you will need to press **Lock Hz Esc** to unlock the tester, even if the test has already stopped.

## Timed (T) insulation resistance/earth-bond resistance test

Use the timed test to obtain measurement results with consistent test times – for later comparisons. Set up your tester as shown in [Figure 2-1](#), and follow the steps shown below.



**Figure 2-2** T operation

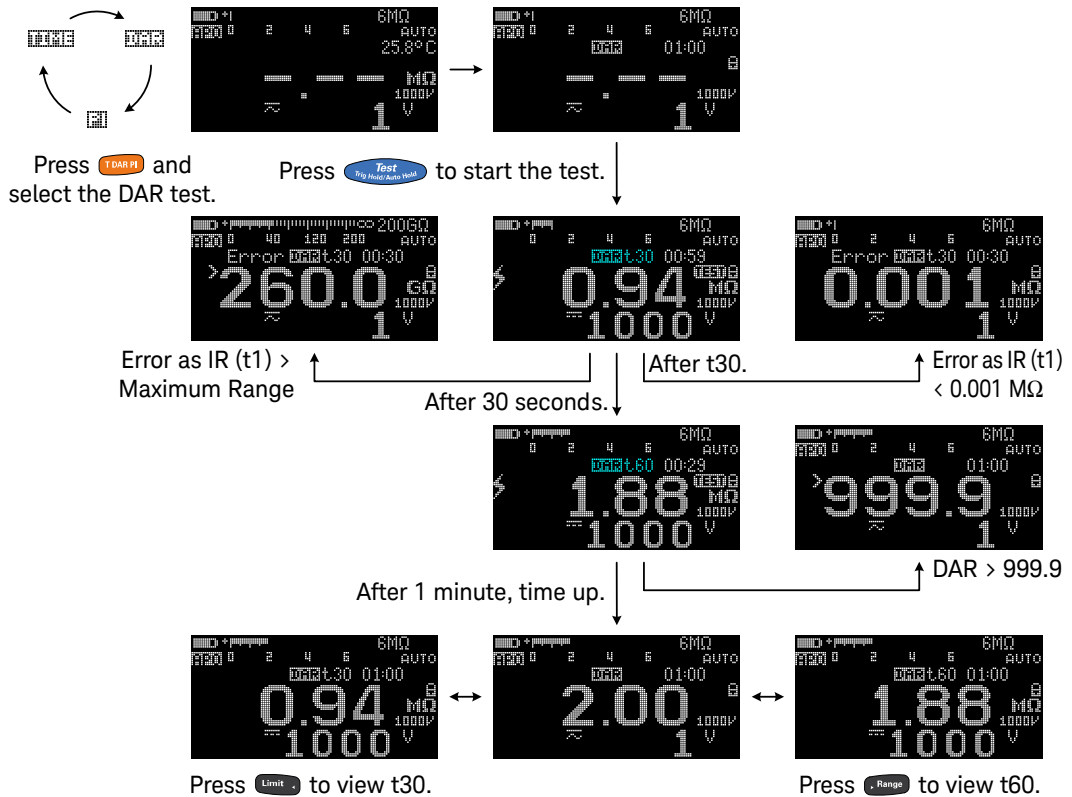
**NOTE**

- Because of the time required to perform the T, PI, and DAR tests, the use of alligator test clips is recommended.
- The length of the timer is 1 minute by default. To change this value, see [“Changing the insulation resistance and earth-bond resistance test period”](#) on page 151 for more information.



## Measuring the Dielectric Absorption Ratio (DAR)

Dielectric Absorption Ratio (DAR) is the ratio of the insulation resistance tested at 60 seconds to the insulation resistance tested at 30 seconds. Set up your tester as shown in [Figure 2-1](#), and follow the steps shown below.



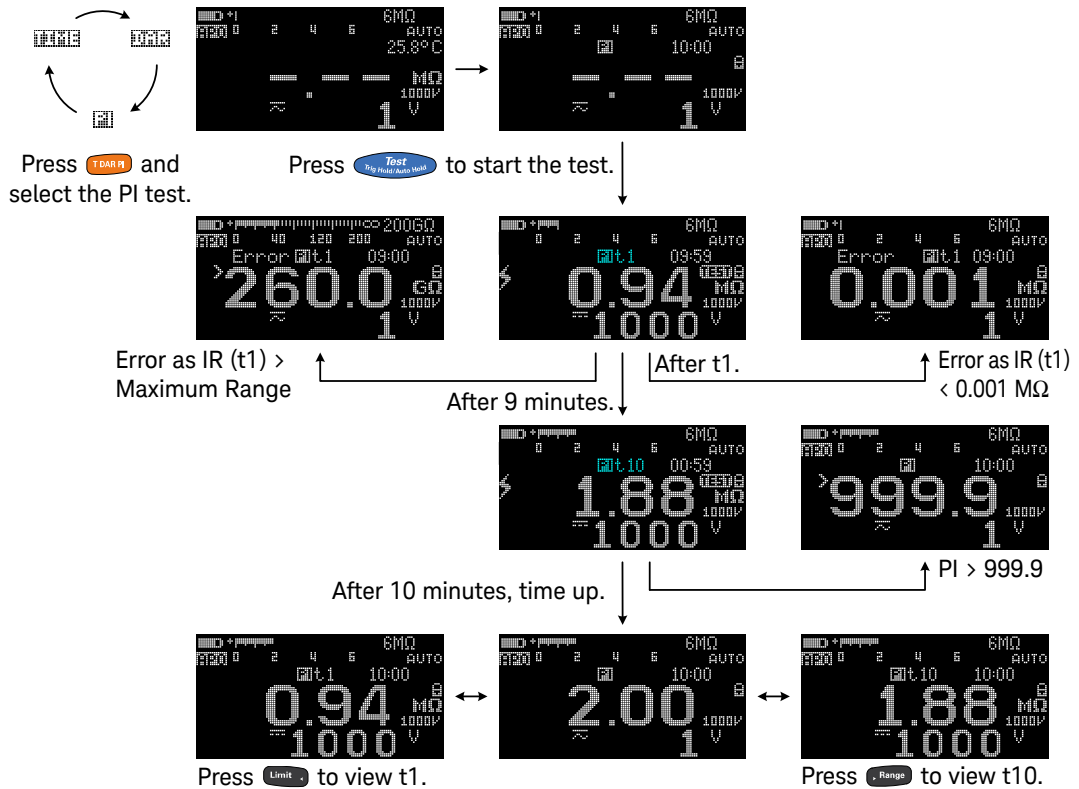
**Figure 2-3** DAR operation

**NOTE**

You can change the DAR from 60:30 to 60:15 in the Setup. See [“Changing the Dielectric Absorption Ratio \(DAR\) for insulation resistance tests”](#) on page 148 for more information. **Error** is shown on the display if the IR is greater than the maximum range or less than 0.001 MΩ after t1/t15/t30; if the test is interrupted by the user; or if the tester’s battery is low.

## Measuring the Polarization Index (PI)

Polarization Index (PI) is the ratio of the insulation resistance tested at 10 minutes to the insulation resistance tested at 1 minute. Set up your tester as shown in **Figure 2-1**, and follow the steps shown below.



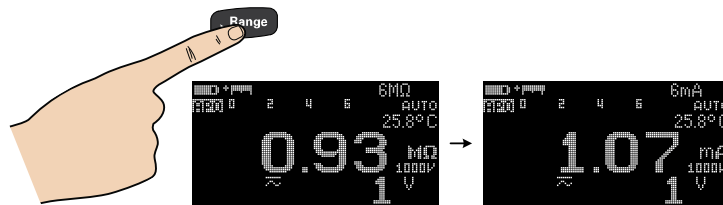
**Figure 2-4** PI operation

**NOTE**

**Error** is shown on the display if the IR is greater than the maximum range or less than 0.001 MΩ after t1/t15/t30; if the test is interrupted by the user; or if the tester's battery is low.

## Viewing the leakage current

Press **Range** to view the leakage current display. The leakage current display is related to the insulation resistance. The higher the resistance tested, the lower the current is to be measured.



## Performing leakage current trip tests

This function may be used to test MOVs (Metal Oxide Varistors), gas discharge tubes, voltage arresters, or sparking gaps. The voltage source will be stopped when the current is greater than the trip current set.

You can select the test voltage and set the current for tripping the test. The trip or breakdown current can be adjusted from 0.001 mA to 1.500 mA from the Setup (see [page 153](#)) or by pressing **ΔNull** before starting the test.

### NOTE

T/DAR/PI tests, Null, Limit, and test lock is disabled when leakage current trip tests or stepped voltage trip tests are enabled.

Set up your tester as shown in Figure 2-1, and follow the steps shown in Figure 2-5.

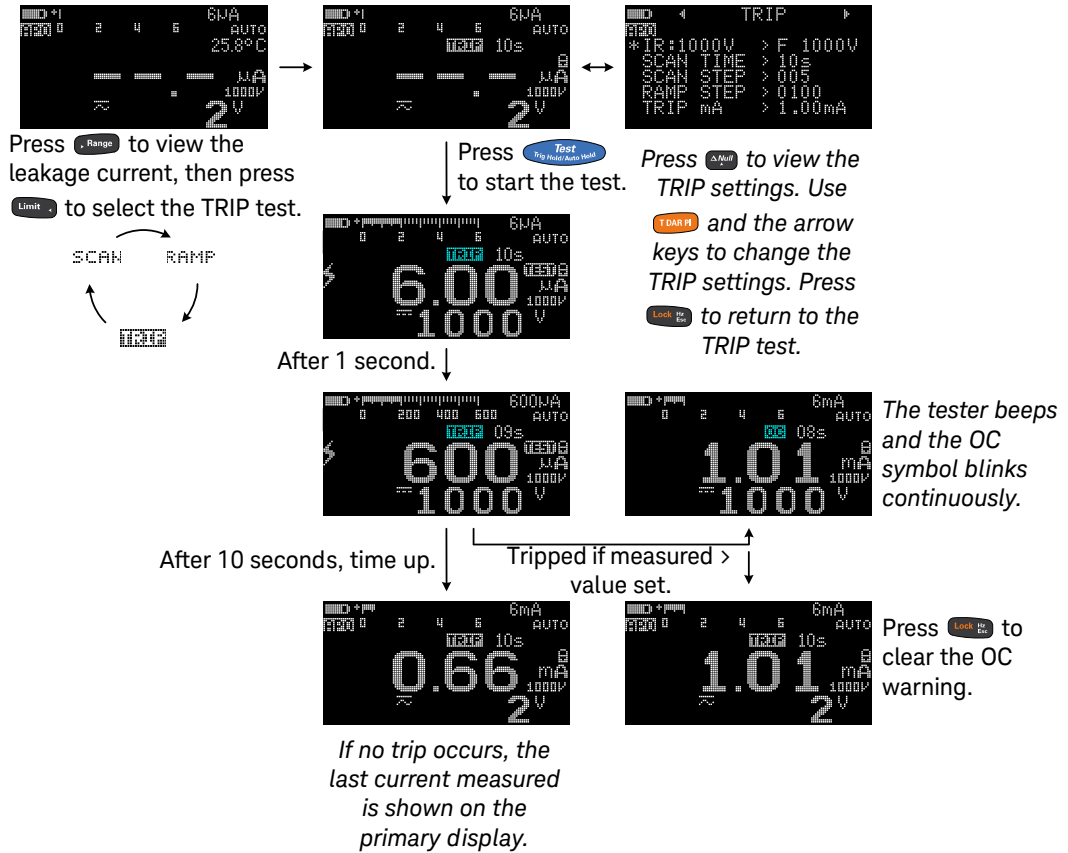


Figure 2-5 TRIP operation

## Performing stepped voltage trip tests

### Scan


A typical scan signal length is based on the following parameters:

- **IR TEST VOLTAGE** - the amplitude end position
- **SCAN STEP** - the number of steps required to reach the amplitude end position
- **SCAN TIME** - the dwelling time length for each step

#### NOTE

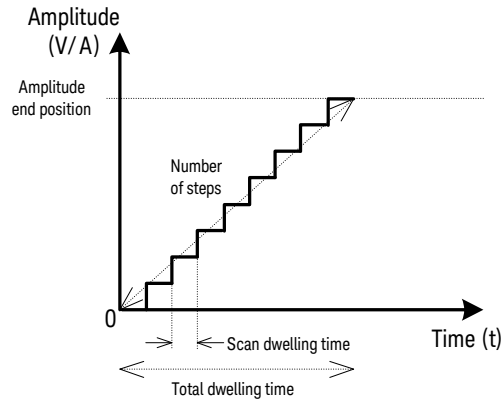
- The TRIP test method involves the application of high direct voltage in a series of uniform voltage steps at regular time intervals. The minimum voltage step is 10 V. Each step should be set to greater than 10 V and the last step is equal to or less than the test voltage setting.
- As an example, if the SCAN STEP is set to 5; for the 1000 V test voltage setting, the test voltage is sent out at the following intervals: 200 V, 400 V, 600 V, 800 V, and 1000 V.

---

You can configure the scan signal amplitude end position, number of steps (1 to 100 steps), and dwelling time length (1 to 99 seconds) in the Setup (see [page 151](#) and [page 152](#)) or by pressing  before starting the test.

## 2 Making Measurements

The total dwell time will increase with respect to the number of steps and the scan dwell time selected. The scan dwell time is defined as the length of time the scan signal will “dwell” in the present step before incrementing to the next step.



**Figure 2-6** Scan signal

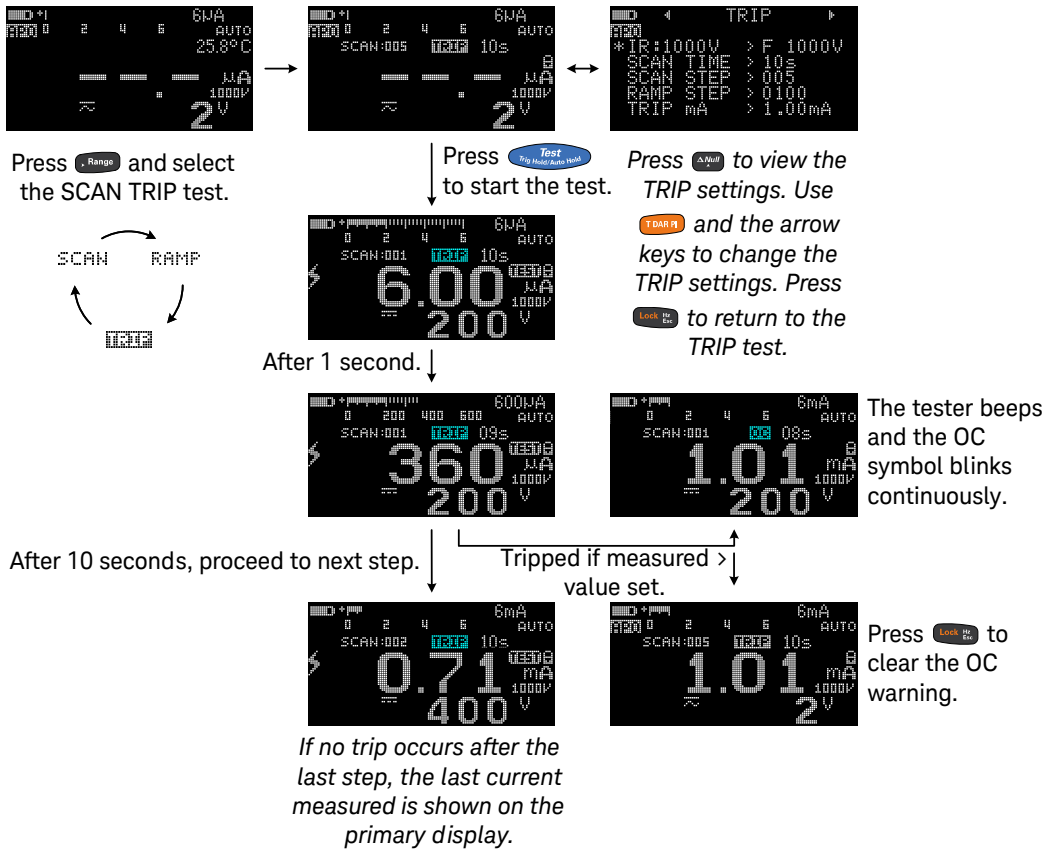


Figure 2-7 SCAN TRIP operation

### Ramp

A typical ramp signal length is based on the following parameters:

- **IR TEST VOLTAGE** - the amplitude end position, and
- **RAMP STEP** - the number of steps required to reach the amplitude end position.

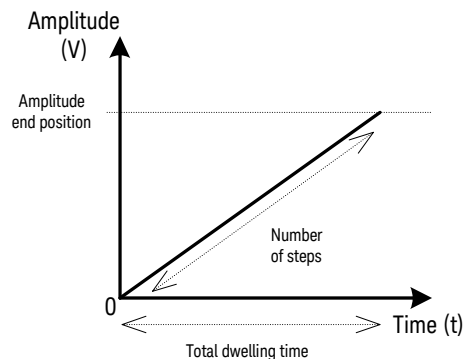
#### NOTE

The principal advantages of the ramped voltage test over the conventional stepped voltage methods are that it gives better control and improved warning of impending failure to avoid damage to the insulation. Elimination of the human variable from the time, voltage, and current parameters yields overall test results which are much more accurate and repeatable.

You can configure the ramp signal amplitude end position and number of steps in the Setup (see [page 153](#)) or by pressing  before starting the test.

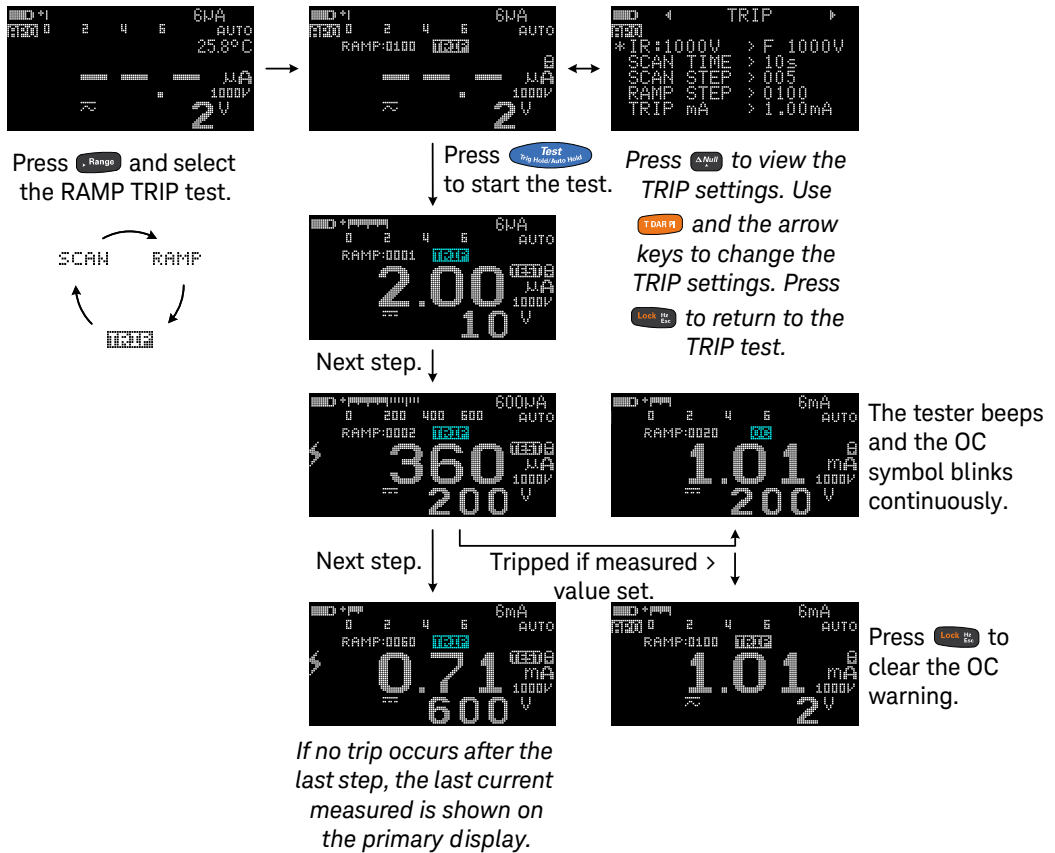
The ramp dwelling time will be set to the fastest of the instrument capability. A higher number of steps provides a more linear ramp signal. This however will result in an increase in the total dwelling time.

A lower number of steps will result in a shorter total dwelling time and a more stepped ramp signal.



**Figure 2-8** Ramp signal

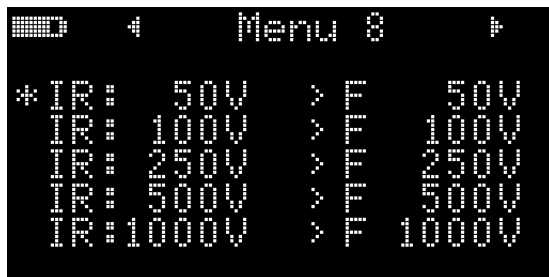




**Figure 2-9** RAMP TRIP operation

## Changing the insulation resistance test voltage

You can adjust the test voltage value of each test voltage position (see [Table 2-1](#)) from the Setup menu ([Menu 8](#)).



[Table 2-2](#) lists the available range for each test voltage position. See [“Changing the insulation resistance test voltage”](#) on page 149 for more information.

**Table 2-2** User test voltage range for insulation resistance


Rotary switch position	Parameter	Range	
		F(actory) default	Available U(ser) range <sup>[a]</sup>
$\Omega$ Mega 50V	IR: 50 V	50 V	10 V to 60 V
$\Omega$ Mega 100V	IR: 100 V	100 V	10 V to 120 V
$\Omega$ Mega 250V	IR: 250 V	250 V	10 V to 300 V
$\Omega$ Mega 500V	IR: 500 V	500 V	10 V to 600 V
$\Omega$ Mega 1000V	IR: 1000 V	1000 V	10 V to 1100 V

[a] Minimum increment of 1 V between each subsequent value.

## Earth-Bond Resistance Test

Set up your tester to perform earth-bond resistance tests as shown in [Figure 2-10](#).

**Table 2-3** Earth-bond resistance test position

Legend	Default function		Function when  is pressed	
Rotary switch position	Primary display	Secondary display	Primary display	Secondary display
$\Omega_{EB}$	Earth-bond resistance test	AC+DC V or DC V (during test)	Timed (T) test	AC+DC V or DC V (during test)

### CAUTION

- To avoid possible damage to your tester or to the equipment under test, disconnect the circuit power and discharge all high-voltage capacitors before measuring resistance.
- The tester automatically detects if the circuit is energized. If the external voltage is detected to be greater than 2 V, the test is inhibited and  $\text{OVe} > 2\text{V}$  is shown on the display. Disconnect the tester and remove power before proceeding.

### NOTE

- The earth-bond resistance function is used to measure the resistance between earth conductors, protective earth conductors, and conductors for equipotential bonding, including their connections and terminals. The function includes an indication of the measured value or indication of limits.
- The voltage source is  $< 6.8\text{ V}$ , and the current is  $> 200\text{ mA}$  when the resistance of  $\leq 2\ \Omega$  is to be measured. When the source voltage is  $< 4.7\text{ V}$ , the tester will inhibit the test automatically. The secondary display indicates the voltage (with auto-ranging enabled).
- The APO (auto power-off) function is disabled during the test.
- See also [“Timed \(T\) insulation resistance/earth-bond resistance test”](#) on page 56.

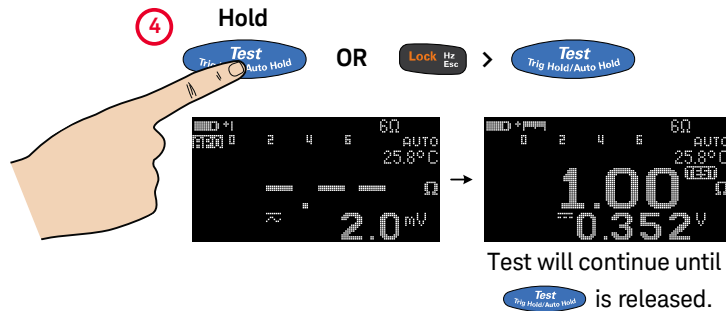
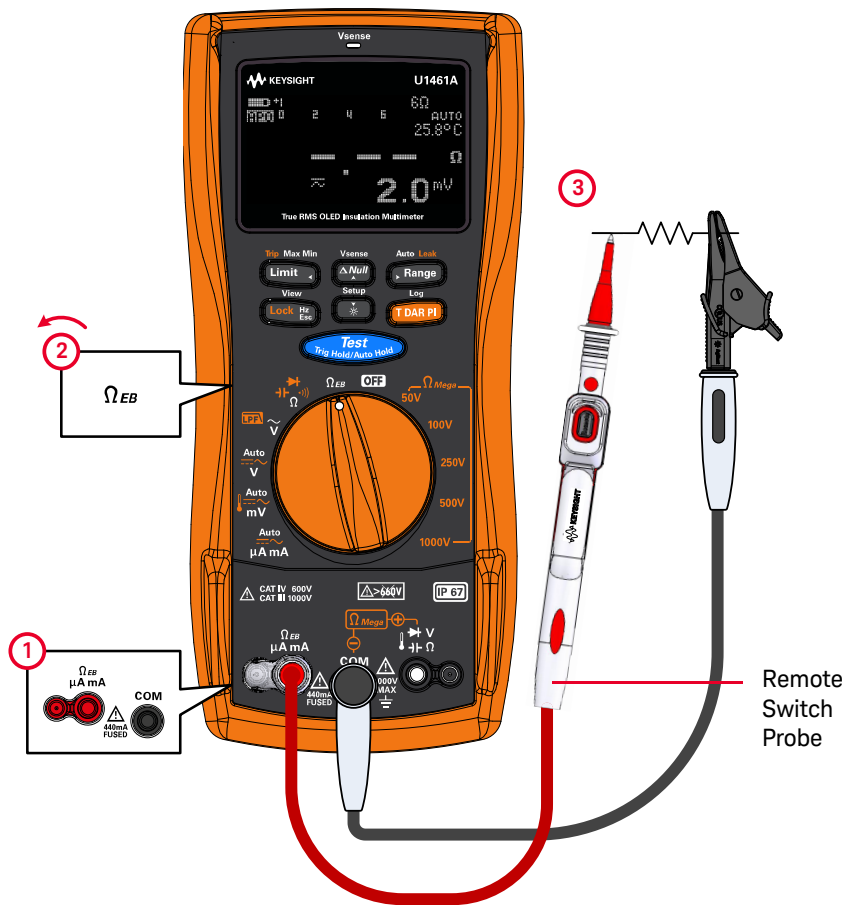



Figure 2-10 Earth-bond resistance test example

### Using the earth-bond resistance test to verify the fuse condition

- 1 Keep the test leads open, and ensure that no voltage is applied to the terminals.
- 2 Press and hold  to verify the fuse condition.
- 3 If the fuse has been blown, **FUSE OPEN** will be shown on the display. Follow the instructions in the *U1461A/U1453A Service Guide* to replace the fuse.







Fuse blown;  
replace fuse.




## Measuring AC or DC Voltage

Set up your tester to measure AC or DC voltage as shown in [Figure 2-11](#).

**Table 2-4** AC and DC voltage measurement positions

Legend	Default function		Function when  is pressed	
Rotary switch position	Primary display	Secondary display	Primary display	Secondary display
 	AC V	-	AC V with LPF	-
	AC V	-	-	-
			<i>Cycles between</i>	
	Auto (V)	AC+DC V	<b>1</b> DC V	<b>1</b> AC+DC V
			<b>2</b> AC V	<b>2</b> AC+DC V
			<b>3</b> Auto (V)	<b>3</b> AC+DC V
			<i>Cycles between</i>	
	Auto (mV)	AC+DC mV	<b>1</b> DC mV	<b>1</b> AC+DC mV
			<b>2</b> AC mV	<b>2</b> AC+DC mV
			<b>3</b> Temperature	<b>3</b> -, °C, or °F
			<b>4</b> Auto (mV)	<b>4</b> AC+DC mV

### NOTE

- AC voltage measurements measured with this tester are returned as true RMS (root mean square) readings. These readings are accurate for sinusoidal waves and other waveforms with no DC offset, such as square waves, triangle waves, and staircase waves.
- This tester displays DC voltage values as well as their polarity. Negative DC voltages will return a negative sign on the left of the display.
- Press  to measure the frequency of the voltage source. See [“Measuring Frequency”](#) on page 79 to learn more.

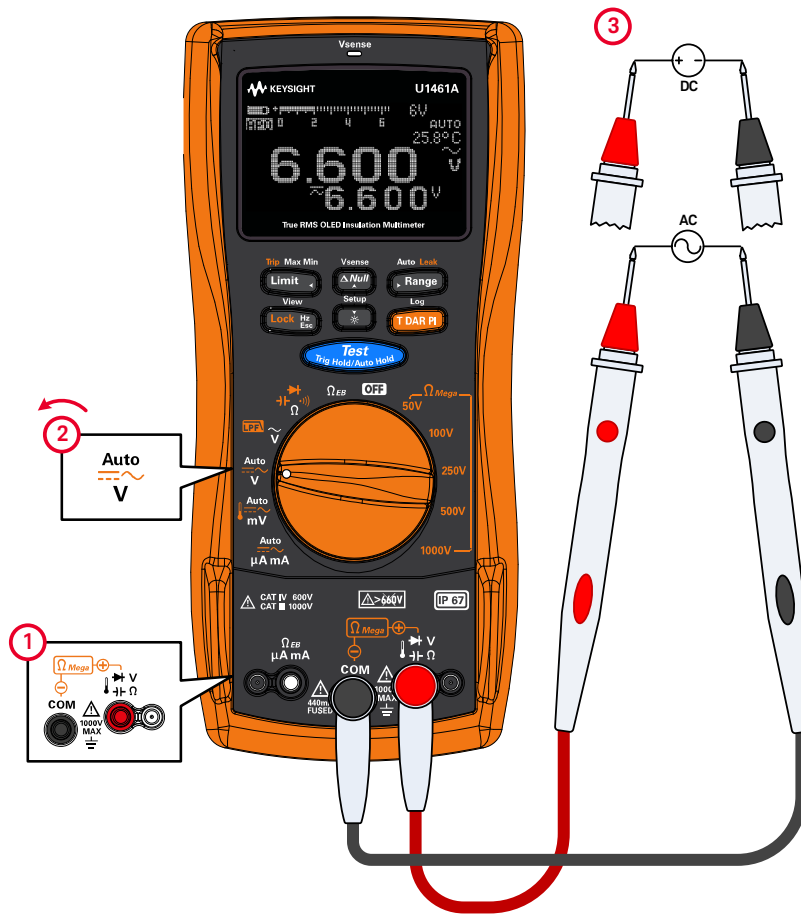


Figure 2-11 AC or DC voltage measurement example

## Auto AC or DC signal identification

The **Auto** function is able to automatically identify the signal component (AC or DC) of an electrical source and select a suitable measurement range according to the AC+DC reading.

The symbol **AUTO** blinks during the identification.



The **Auto** function identifies the signal component using the following rules:

- It will consider which component value is greater between the AC or DC.
- The AC value should be greater than a minimum value of 50 counts (based on 6000 counts) of range to prevent residual value due to range changing.
- The frequency measured is greater than 10 Hz for the AC mode.

While the signal is being identified, you can press **T D A R P I** to lock the (AC or DC) signal on the primary display.

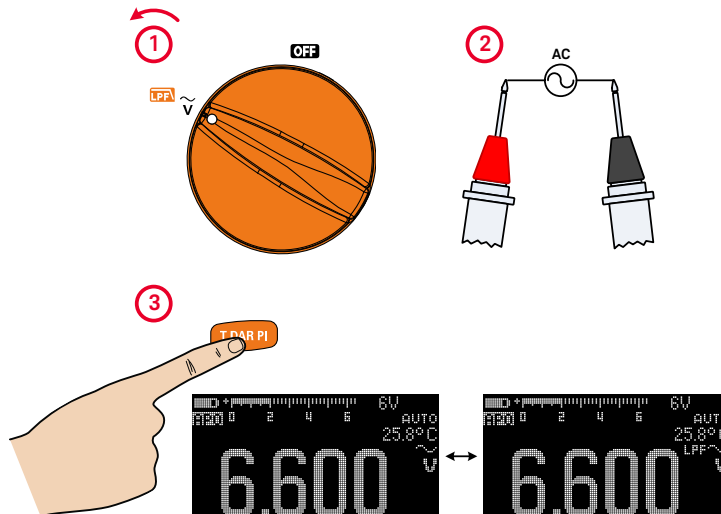
At any time, you can press **Range** to stop the **Auto** function and lock the identified signal component (AC or DC).



## Using the LPF (Low Pass Filter) feature for AC signals

For model U1461A only: Your tester is equipped with an AC low-pass filter to help reduce unwanted electronic noise when measuring AC voltage or AC frequency.

Set up your tester to measure AC voltage as shown in [Figure 2-11](#). Turn the rotary knob to **LPA**  $\tilde{V}$  and press **T D A R P I** to activate the LPF option. Your tester continues measuring in the chosen AC mode, but now the signal diverts through a filter that blocks unwanted voltages above 1 kHz. Probe the test points, and read the display.



**Figure 2-12** AC voltage with LPF measurement example

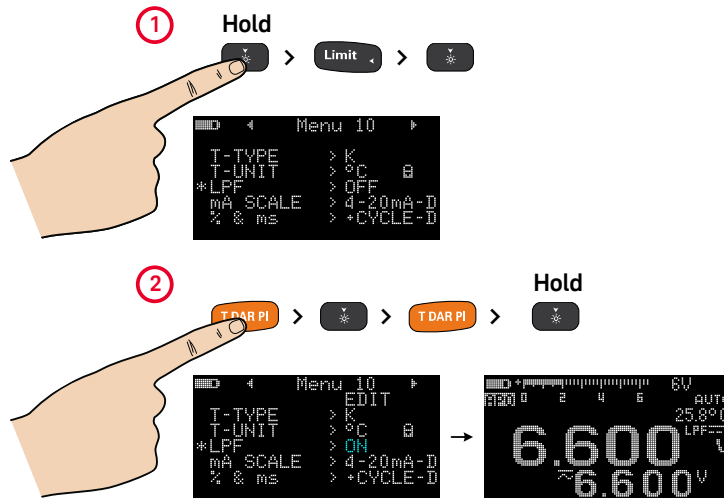
**WARNING**

- To avoid possible electric shock or personal injury, do not use the LPF option to verify the presence of hazardous voltages. Voltages greater than what is indicated may be present. First, make a voltage measurement without the filter to detect the possible presence of hazardous voltages. Then, select the filter option.
  - When the LPF option is selected, the measurement function will switch to the manual range mode (defaults to 600 V) for variable speed drive (VSD) applications. It is recommended only to use 600 V and 1000 V in the manual range for VSD testing.
- 

The low-pass filter can improve measurement performance on composite sine waves that are typically generated by inverters and variable frequency motor drives.

## Enabling the LPF in the Setup

You can also enable the low-pass filter to block and attenuate AC signals above 1 kHz for the AC or DC paths of V, mV, and  $\mu\text{A}$  mA measurements. See [“Enabling the low-pass filter”](#) on page 156 for more information.





**Figure 2-13** Enabling the low-pass filter

## Measuring AC or DC Current

Set up your tester to measure AC or DC current as shown in [Figure 2-14](#). Open the circuit path to be tested.

**Table 2-5** AC and DC current measurement positions

Legend	Default function		Function when  is pressed	
Rotary switch position	Primary display	Secondary display	Primary display	Secondary display
	Auto ( $\mu\text{A}$ mA)	AC+DC ( $\mu\text{A}$ mA)	<i>Cycles between</i>	
			1 DC ( $\mu\text{A}$ mA)	1 AC+DC ( $\mu\text{A}$ mA)
			2 AC ( $\mu\text{A}$ mA)	2 AC+DC ( $\mu\text{A}$ mA)
			3 % Scale of 4-20 mA	3 DC mA
			4 Auto ( $\mu\text{A}$ mA)	4 AC+DC ( $\mu\text{A}$ mA)

### WARNING

Never measure voltage by the current measurement terminals and never attempt an in-circuit current measurement where the open-circuit potential to earth is greater than 1000 V. Doing so will cause damage to the tester and possible electric shock or personal injury.

### CAUTION

To measure current, you must turn off power to the circuit and discharge all high-voltage capacitors. Then, open the circuit under test, and place the tester in series with the circuit. Insert the black test lead into the **COM** terminal and insert the red test lead to the  **$\mu\text{A}$  mA** terminal. Never place the probes across (in parallel with) any circuit or component when the leads are plugged into the current terminals.

### NOTE

Reversing the leads will produce a negative reading, but it will not damage the tester. Check the tester's fuses when no current is measured.

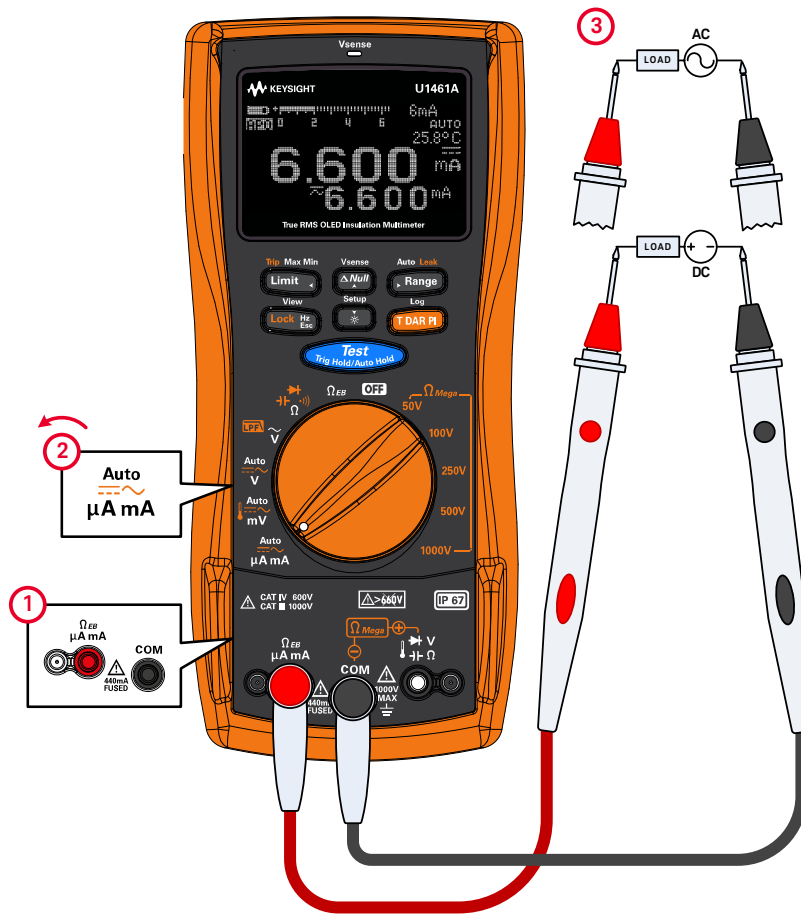



Figure 2-14 AC or DC current measurement example


**CAUTION**

Placing the probes across (in parallel with) a powered circuit when a lead is plugged into a current terminal can damage the circuit you are testing and blow the tester's fuse. This happens because the resistance through the tester's current terminals are very low, resulting in a short circuit.

**NOTE**

- Press  to measure the frequency of the AC or DC current source. See “[Measuring Frequency](#)” on page 79 to learn more.
- The **Auto** function is able to automatically identify the signal component (AC or DC) of an electrical source. See “[Auto AC or DC signal identification](#)” on page 72 to learn more.

## % Scale of 4-20 mA or 0-20 mA

To display the current measurement in % scale, set up your tester to measure DC current as shown in [Figure 2-14](#), then press  until the % scale is shown.

**NOTE**

- The 4-20 mA current loop output from a transmitter is a type of electrical signal that is used in a series circuit to provide a robust measurement signal that is proportional to the applied pressure, temperature, or flow in process control. The signal is a current loop where 4 mA represents the zero percent signal and 20 mA represents the 100 percent signal.
- The % scale for 4-20 mA or 0-20 mA in this tester is calculated using its corresponding DC mA measurement. The tester will automatically optimize the best resolution for the selected measurement. Two ranges are available for the % scale as shown in [Table 2-6](#).

The analog bar graph displays the current measurement value. (In the example above, 24 mA is represented as 125% in the 4-20 mA % scale.)


**Table 2-6** % Scale measurement range

% Scale of 4-20 mA or 0-20 mA	DC mA measurement range
999.99%	6 $\mu$ A or 600 mA <sup>[a]</sup>
9999.9%	






[a] Applies to both autoranging and manual range selection.

You can change the % scale range (4-20 mA or 0-20 mA) in the Setup ([page 157](#)). Use the % scale with a pressure transmitter, a valve positioner, or other output actuators to measure pressure, temperature, flow, pH, or other process variables.

## Measuring Frequency

Your tester allows simultaneous monitoring of real-time voltage or current with frequency measurements. To measure frequency, rotate the switch to one of the positions highlighted in [Table 2-7](#) and set up the tester accordingly. Press . Probe the test points, and read the display.


**Table 2-7** Measurement positions allowing frequency measurements

Legend	Default function	
Rotary switch position	Primary display	Secondary display
	AC V	-
	AC V	-
	Auto (V)	AC+DC V
	Auto (mV)	AC+DC mV
	Auto ( $\mu$ A mA)	AC+DC ( $\mu$ A mA)

### WARNING

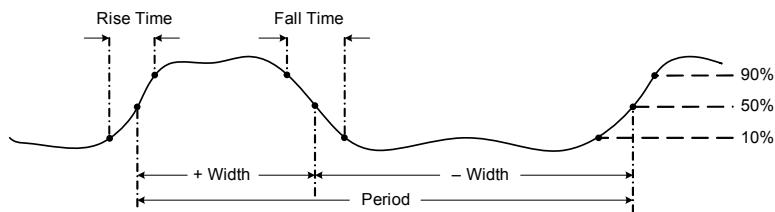
Never measure the frequency where the voltage or current level exceeds the specified range. Manually set the voltage or current range if you want to measure frequencies below 20 Hz.

### NOTE

- Pressing  controls the input range of the primary function (voltage or ampere) and not the frequency range.
- To obtain the best measuring results for frequency measurements, please use the AC measuring path.

### Frequency measurement techniques

- Measuring the frequency of a signal helps detect the presence of harmonic currents in neutral conductors and determines whether these neutral currents are the result of unbalanced phases or non-linear loads.
- Frequency is the number of cycles a signal completes each second. Frequency is defined as  $1/\text{Period}$ . Period is defined as the time between the middle threshold crossings of two consecutive, like-polarity edges, as shown in [Figure 2-15](#).
- The tester measures the frequency of a voltage or current signal by counting the number of times the signal crosses a threshold level within a specified period of time.
- If a reading shows as 0 Hz or is unstable, the input signal may be below or near the trigger level. You can usually correct these problems by manually selecting a lower input range, which increases the sensitivity of the tester.
- If a reading seems to be a multiple of what you expect, the input signal may be distorted. Distortion can cause multiple triggerings of the frequency counter. Selecting a higher voltage range might solve this problem by decreasing the sensitivity of the tester. In general, the lowest frequency displayed is the correct one.
- The frequency of the input signal is shown in the primary display. The voltage or ampere value of the signal is shown in the secondary display. The bar graph does not indicate frequency but indicates the voltage or ampere value of the input signal.




**Figure 2-15** Definition of frequency





## Measuring duty cycle and pulse width

You must first enable the duty cycle and pulse width display in the Setup menu. See “[Enabling the \(+ or -\) duty cycle and pulse width display](#)” on page 157 for more information.

While displaying voltage or current frequency, press  to select the measurement as a percentage (%) for duty cycle or in the millisecond (ms) unit for pulse width.



### NOTE

- The duty cycle (or duty factor) of a repetitive pulse train is the ratio of the positive or negative pulse width to the period expressed as a percentage. The duty-cycle function is optimized for measuring the on or off time of logic and switching signals. Systems such as electronic fuel injection systems and switching power supplies are controlled by pulses of varying width, which can be checked by measuring the duty cycle.
- The pulse width function measures the amount of time a signal is high or low. It is the time from the middle threshold of the rising edge to the middle threshold of the next falling edge. The measured waveform must be periodic; its pattern must repeat at equal time intervals.
- The bar graph does not indicate duty cycle or pulse width value but indicates the voltage or ampere value of the input signal.
- The duty cycle polarity is displayed to the left of the duty cycle value.  indicates a positive pulse width and  indicates a negative pulse width. Change the polarity in the Setup (see [page 157](#)).

## Measuring Resistance

Set up your tester to measure resistance as shown in [Figure 2-16](#).

**Table 2-8** Resistance measurement position

Legend	Default function		Function when  is pressed			
Rotary switch position	Primary display	Secondary display	Primary display	Secondary display		
	Resistance	-	<i>Cycles between</i>			
			1	Continuity	1	-
			2	Diode	2	-
			3	Capacitance	3	Cable length
			4	Resistance	4	-



### CAUTION

To avoid possible damage to your tester or to the equipment under test, disconnect the circuit power and discharge all high-voltage capacitors before measuring resistance.

### NOTE

Resistance (opposition to the current flow) is measured by sending a small current out through the test leads to the circuit under test. Because this current flows through all possible paths between the leads, the resistance reading represents the total resistance of all paths between the leads. Resistance is measured in ohms ( $\Omega$ ).

Keep the following in mind when measuring resistance.

- The test leads can add 0.1  $\Omega$  to 0.2  $\Omega$  of error to resistance measurements. To test the leads, touch the probe tips together and read the resistance of the leads. To remove lead resistance from the measurement, hold the test lead tips together and press . Now the resistance at the probe tips will be subtracted from all future display readings.
- Because the tester's test current flows through all possible paths between the probe tips, the measured value of a resistor in a circuit is often different from the resistor's rated value.
- The resistance function can produce enough voltage to forward-bias silicon diode or transistor junctions, causing them to conduct. If this is suspected, press  to apply a lower current in the next higher range.

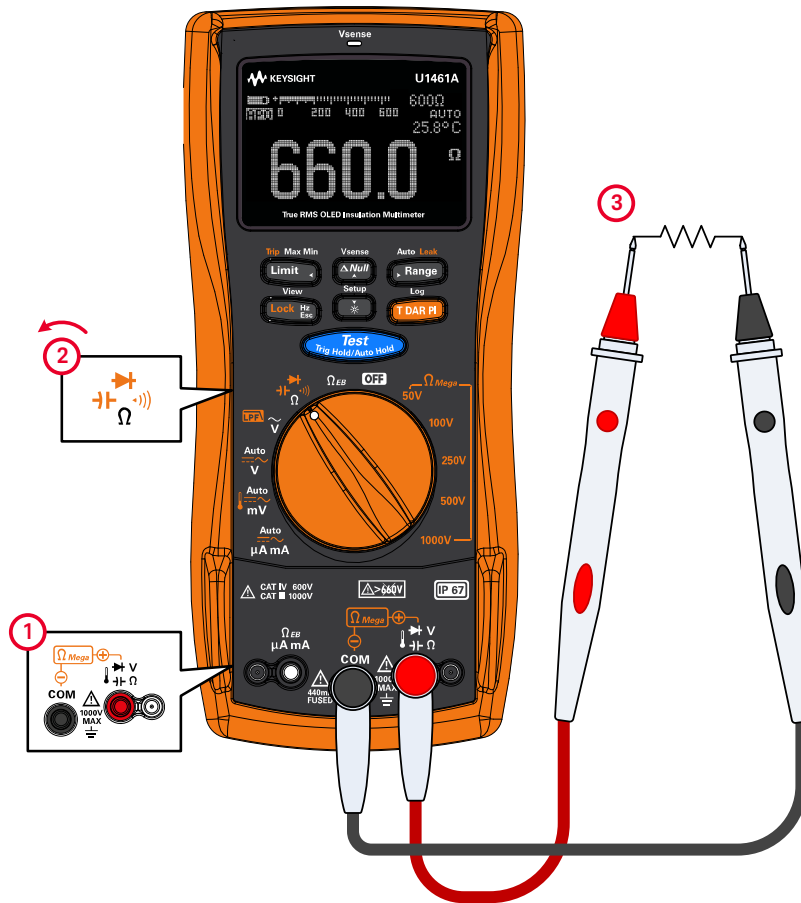




Figure 2-16 Resistance measurement example

## Continuity Test

Set up your tester to perform continuity tests as shown in [Figure 2-17](#). The beeper will sound and the red LED lights up as a continuity indication.

**Table 2-9** Continuity test position

Legend	Default function		Function when  is pressed			
Rotary switch position	Primary display	Secondary display	Primary display	Secondary display		
	Resistance	-	<i>Cycles between</i>			
			1	Continuity	1	-
			2	Diode	2	-
			3	Capacitance	3	Cable length
			4	Resistance	4	-

### CAUTION

To avoid possible damage to your tester or to the equipment under test, disconnect the circuit power and discharge all high-voltage capacitors before testing for continuity.

### NOTE

- Continuity is the presence of circuit continuities. The beeper sounds as the resistance falls down to the threshold, and the red LED indicator will be lit (if enabled in the Setup). The audible and visual alert allows you to perform quick continuity tests without having to watch the display.
- The continuity function detects intermittent shorts and opens lasting as short as 1 ms. A brief short causes the tester to emit a short beep.
- You can enable or disable the audible alert via the Setup. See [“Changing the continuity alert”](#) on page 140 for more information on the audible alert option.

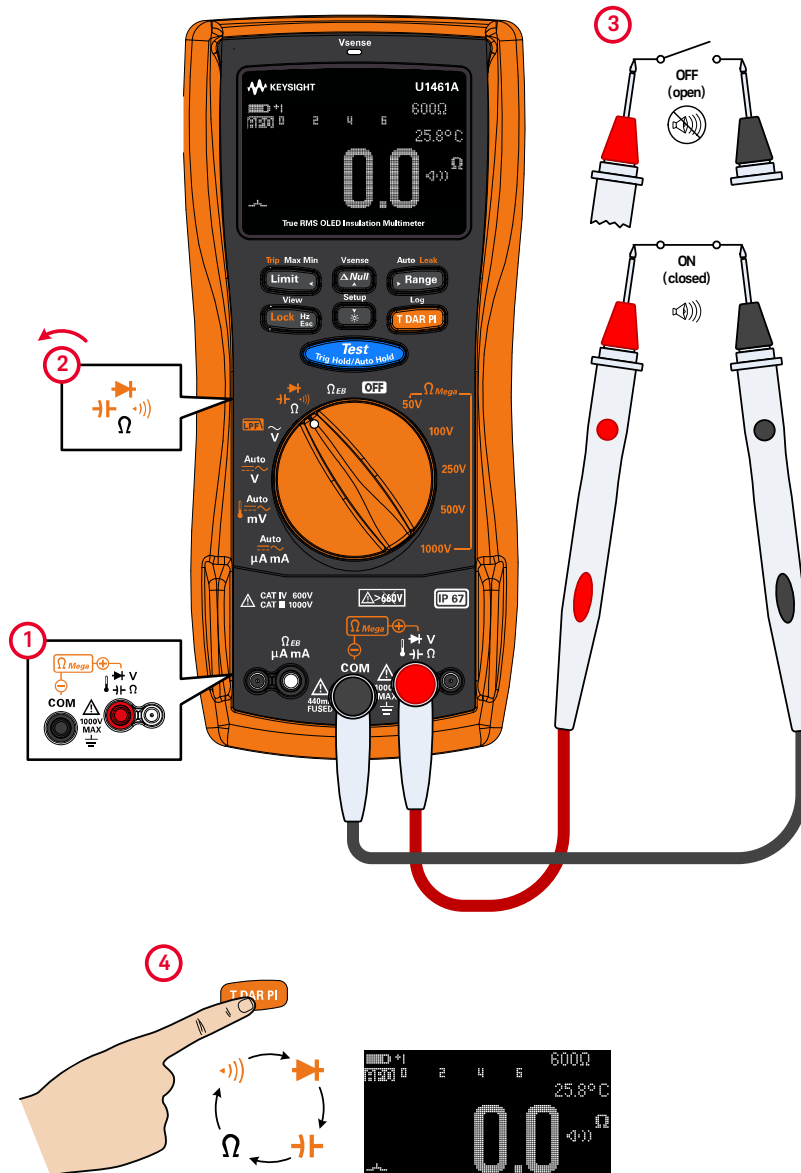




Figure 2-17 Continuity test example

## Diode Test

Set up your tester to perform diode tests as shown in [Figure 2-18](#).

**Table 2-10** Diode test position

Legend	Default function		Function when  is pressed			
Rotary switch position	Primary display	Secondary display	Primary display	Secondary display		
	Resistance	-	<i>Cycles between</i>			
			1	Continuity	1	-
			2	Diode	2	-
			3	Capacitance	3	Cable length
			4	Resistance	4	-

### CAUTION

To avoid possible damage to your tester or to the equipment under test, disconnect the circuit power and discharge all high-voltage capacitors before testing diodes.

### NOTE

- This test sends a current through a semiconductor junction, and then measures the junction's voltage drop. A typical junction drops 0.3 V to 0.8 V.
- Connect the red test lead to the positive terminal (anode) of the diode and the black test lead to the negative terminal (cathode). The cathode of a diode is indicated with a band.
- Your tester can display diode forward-bias of up to approximately 1 V. The forward-bias of a typical diode is within the range of 0.3 V to 0.8 V; however, the reading can vary depending on the resistance of other pathways between the probe tips.
- If the beeper is enabled during diode test, the tester will beep briefly for a normal junction and sound continuously for a shorted junction, below  $0.04 \pm 0.02$  V approx. See [“Changing the beep frequency”](#) on page 131 to disable the beeper.

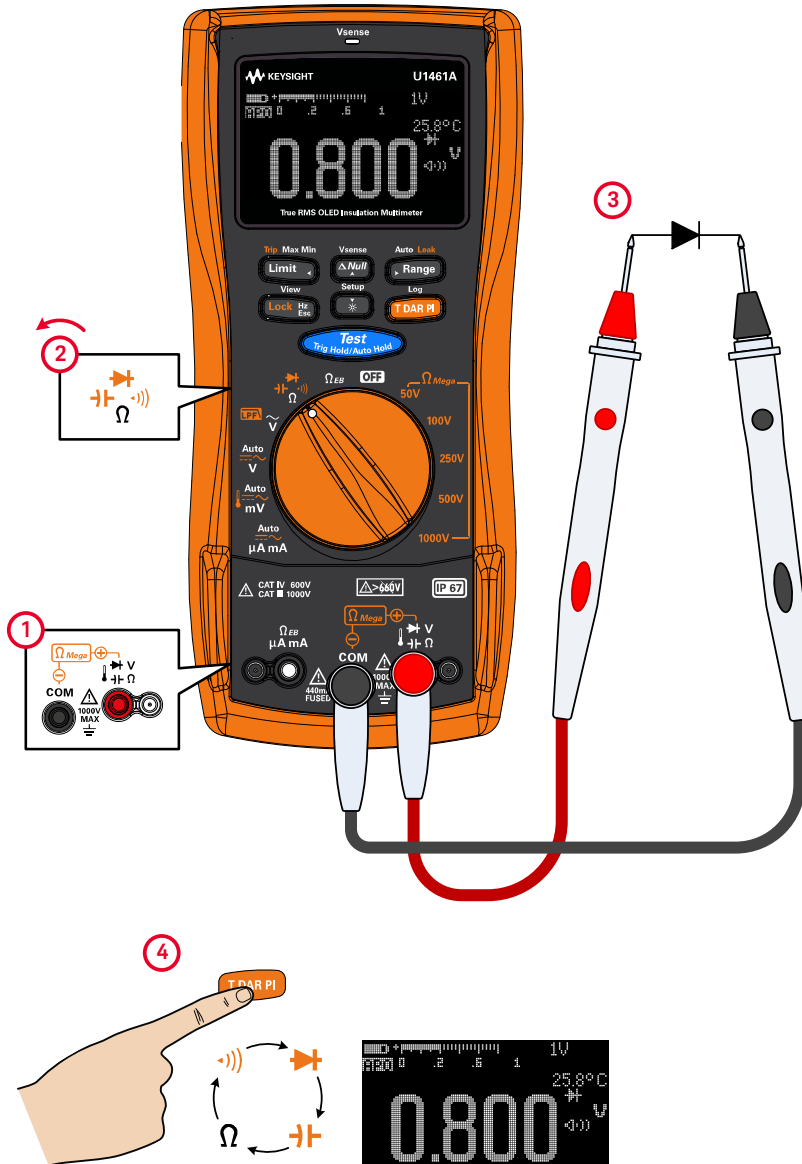


Figure 2-18 Forward-bias diode test example

Reverse the probes (as shown in [Figure 2-19](#)) and measure the voltage across the diode again.

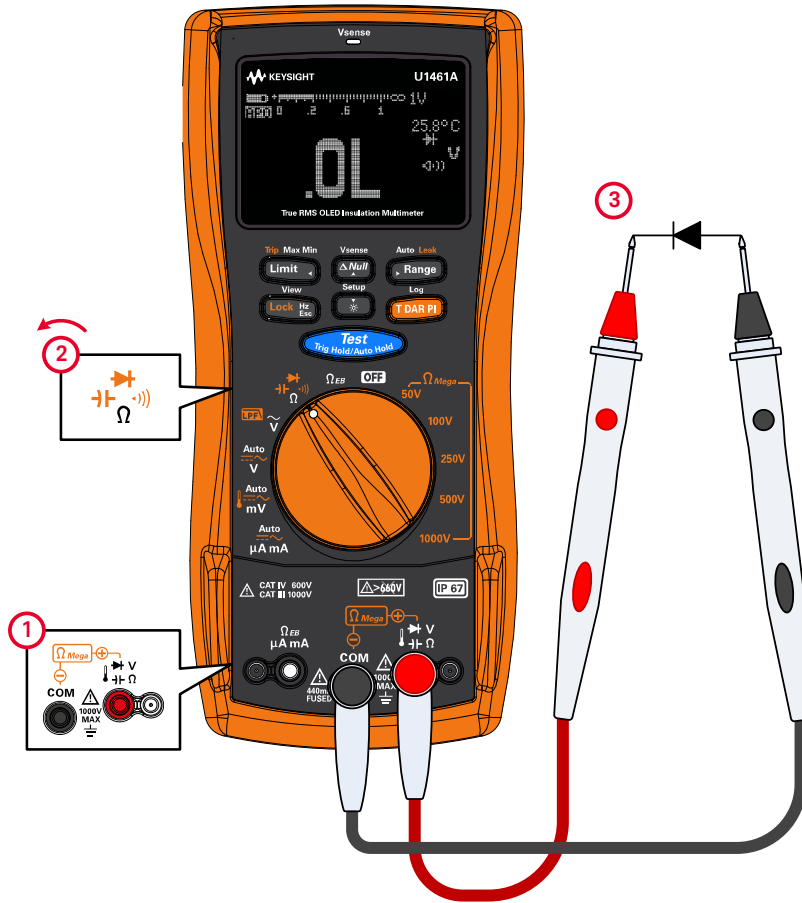


Figure 2-19 Reverse-bias diode test example



### Assessing the diode condition

Assess the diode according to the following guidelines:

- A diode is considered good if the tester displays **OL** in reverse-bias mode.
- A diode is considered shorted if the tester displays approximately 0 V in both forward- and reverse-bias modes, and the tester beeps continuously.
- A diode is considered open if the tester displays **OL** in both forward- and reverse-bias modes.

Use the diode test to check diodes, transistors, silicon controlled rectifiers (SCRs), and other semiconductor devices. A good diode allows current to flow in one direction only.

### Using the Auto-diode feature

Set up your tester to test diodes as shown in [Figure 2-18](#) or [Figure 2-19](#). Press and hold **Range** to toggle the Auto-diode feature. Probe the test points, and read the display.

**NOTE**

The auto-diode function will help you test both forward- and reverse-bias directions simultaneously. You do not need to change the measuring direction to identify the diode's condition.

**Table 2-11** Auto-diode voltage thresholds

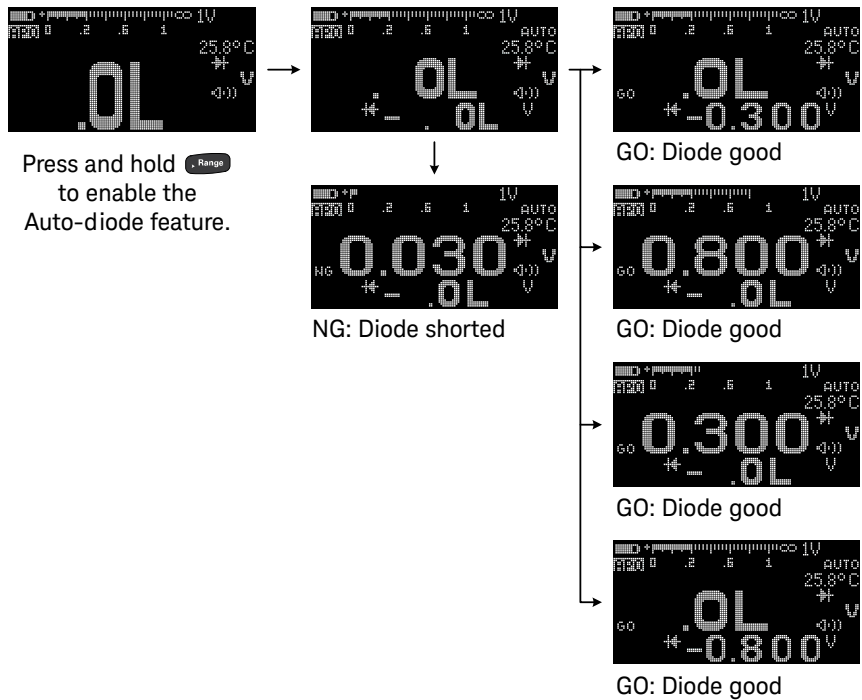
Forward voltage	Reverse voltage	Diode status	
Primary display	Secondary display	GO	NG
OL or <0.3 V or >0.8 V	-OL or >-0.3 V or <-0.8 V		<b>X</b>
Within 0.3 V to 0.8 V	-OL	✓	
OL	Within -0.3 V to -0.8 V	✓	

**NOTE**

The open condition will not be alerted as **OL** on both directions if the auto-diode function is used.

The primary display shows the forward-bias voltage value. The reverse-bias voltage value is shown in the secondary display.

- **GO** is shown briefly (along with a single beep) if the diode is in a good condition.
- **NG** is shown briefly (along with two beeps) if the diode is out of the thresholds.





**Figure 2-20** Auto-diode operation

## Measuring Capacitance

Set up your tester to measure capacitance as shown in [Figure 2-21](#).




**Table 2-12** Capacitance measurement position

Legend	Default function		Function when  is pressed			
Rotary switch position	Primary display	Secondary display	Primary display	Secondary display		
	Resistance	-	<i>Cycles between</i>			
			1	Continuity	1	-
			2	Diode	2	-
			3	Capacitance	3	Cable length
4	Resistance	4	-			

**CAUTION**

To avoid possible damage to the tester or to the equipment under test, disconnect circuit power and discharge all high-voltage capacitors before measuring capacitance. Use the DC voltage function to confirm that the capacitor is fully discharged.

**NOTE**

- The tester measures capacitance by charging the capacitor with a known current for a known period of time, measuring the resulting voltage, and then calculating the capacitance.
-  is shown on the bottom left of the display when the capacitor is charging, and  is shown when the capacitor is discharging.
- To improve measurement accuracy of small value capacitors, press  with the test leads open to subtract the residual capacitance of the tester and leads.
- For measuring capacitance values greater than 1000  $\mu\text{F}$ , discharge the capacitor first, then select a suitable range for measurement. This will speed up the measurement time and also ensure that the correct capacitance value is obtained.

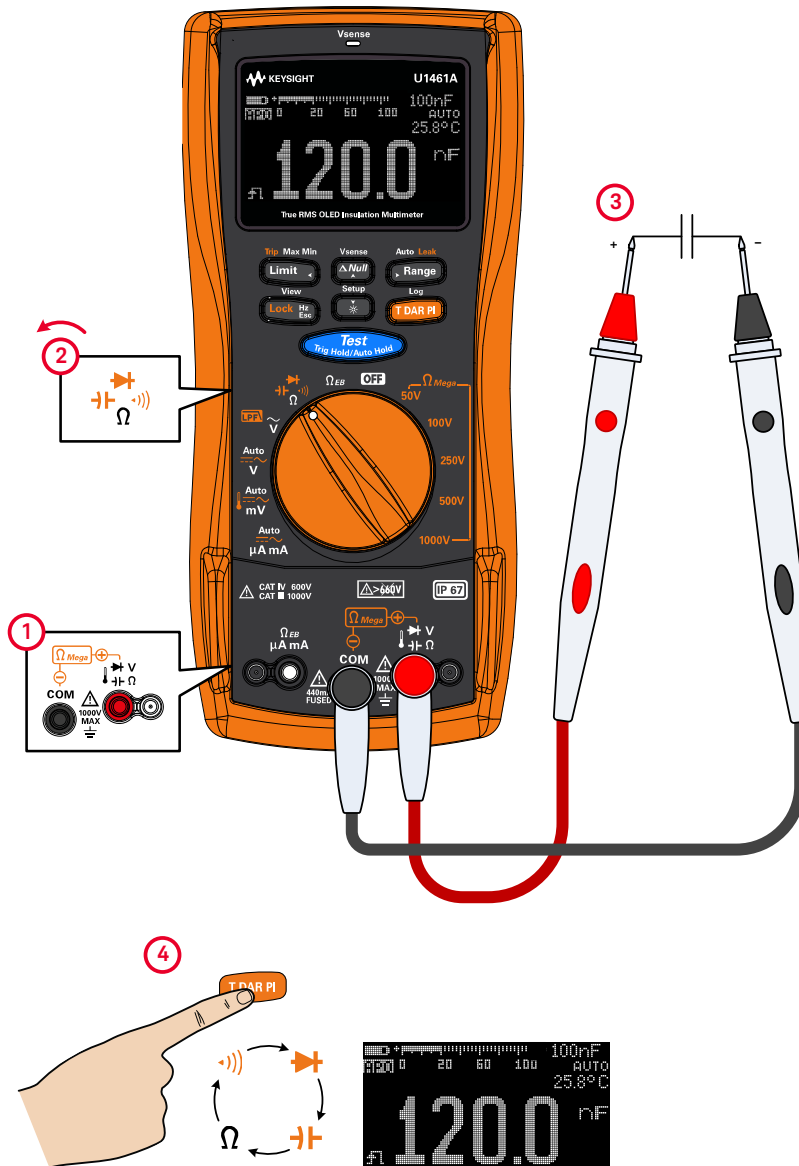
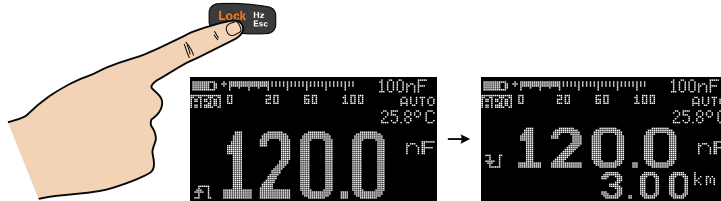


Figure 2-21 Capacitance measurement example

## Viewing the cable length value

Press **Lock Hz Esc** to temporarily display the cable length of the circuit under test in the secondary display.





The default cable length scale is 1 km per 40 nF (km/C). To change this value, see [“Changing the cable length scale”](#) on page 143.

You can also change the cable length unit (Meter or Feet). To change this value, see [“Changing the cable length unit”](#) on page 144.

## Measuring Temperature

The tester uses a type-K (default setting) temperature probe for measuring temperature. To measure temperature, set up your tester as shown in [Figure 2-22](#).

**Table 2-13** Temperature measurement position

Legend	Default function		Function when  is pressed			
Rotary switch position	Primary display	Secondary display	Primary display	Secondary display		
	Auto (mV)	AC+DC mV	<i>Cycles between</i>			
			1	DC mV	1	AC+DC mV
			2	AC mV	2	AC+DC mV
			3	Temperature	3	-, °C, or °F
			4	Auto (mV)	4	AC+DC mV


**WARNING**

Do not connect the thermocouple to electrically live circuits. Doing so will potentially cause fire or electric shock.

**CAUTION**

Do not bend the thermocouple leads at sharp angles. Repeated bending over a period of time can break the leads.

**NOTE**

- Shorting the  terminal to the **COM** terminal will display the temperature at the tester's terminals.
- To change the default thermocouple type from type-K to type-J, see [“Changing the thermocouple type”](#) on page 155 for more information.



The primary display normally shows temperature or the message **OL** (open thermocouple). The open thermocouple message may be due to a broken (open) probe or because no probe is installed into the input jacks of the tester.

**NOTE**


The bead-type thermocouple probe is suitable for measuring temperatures from  $-40\text{ }^{\circ}\text{C}$  to  $204\text{ }^{\circ}\text{C}$  ( $399\text{ }^{\circ}\text{F}$ ) in PTFE-compatible environments. Do not immerse this thermocouple probe in any liquid. For best results, use a thermocouple probe designed for each specific application – an immersion probe for liquid or gel, and an air probe for air measurement.

Observe the following measurement techniques:

- Clean the surface to be measured, and ensure that the probe is securely touching the surface. Remember to disable the applied power.
- When measuring above ambient temperatures, move the thermocouple along the surface until you get the highest temperature reading.
- When measuring below ambient temperatures, move the thermocouple along the surface until you get the lowest temperature reading.
- Place the tester in the operating environment for at least 1 hour as the tester is using a non-compensation transfer adapter with miniature thermal probe.

For quick measurement, use the  compensation to view the temperature variation of the thermocouple sensor. The  compensation assists you in measuring relative temperature immediately.

### Changing the temperature unit

Press  to change the temperature units between  $^{\circ}\text{C}$  or  $^{\circ}\text{F}$  (you must first change the temperature unit to switch between  $^{\circ}\text{C}$  and  $^{\circ}\text{F}$  or  $^{\circ}\text{F}$  and  $^{\circ}\text{C}$ ). See [“Changing the temperature unit”](#) on page 155 for more information.

**CAUTION**

The option to change the temperature unit is locked for certain regions. Always set the temperature unit display per the official requirements and in compliance with the National laws of your region.

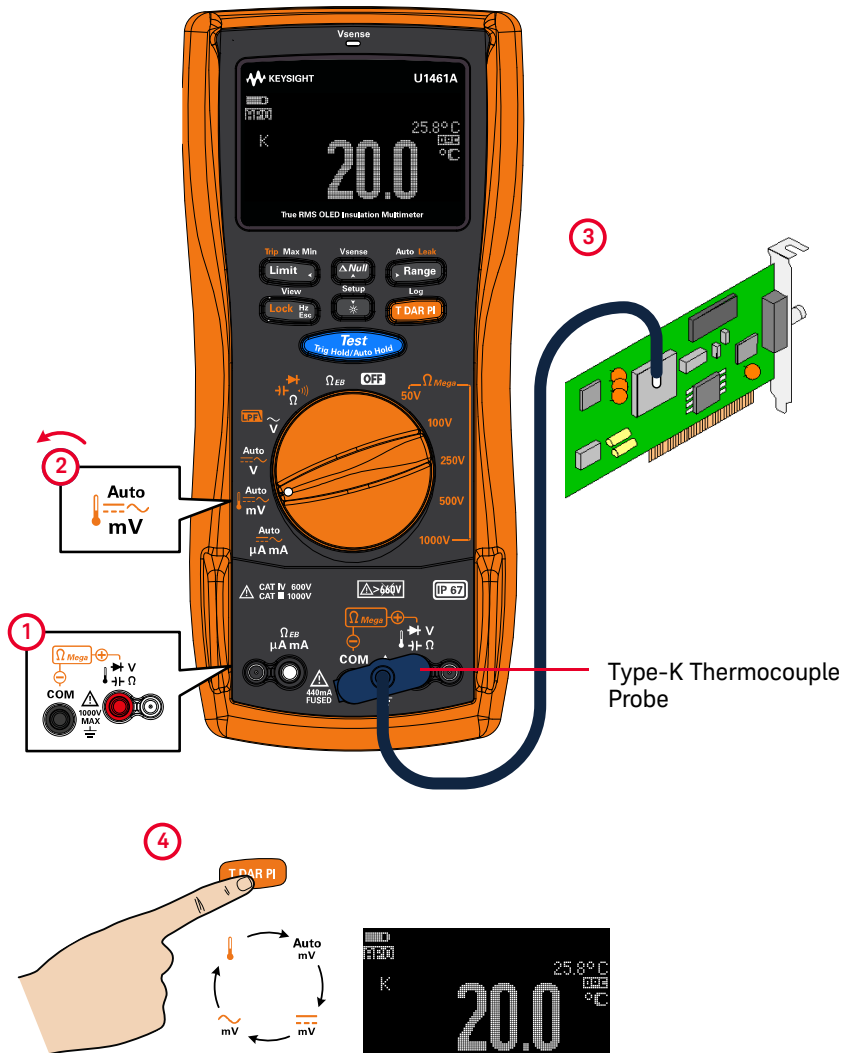





Figure 2-22 Surface temperature measurement example



### Temperature measurement without ambient compensation

If you are working in a constantly varying environment, where ambient temperatures are not constant, do the following:

- 1** Press  for more than 1 second to select  compensation. This allows a quick measurement of the relative temperature.
- 2** Avoid contact between the thermocouple probe and the surface to be measured.
- 3** After a constant reading is obtained, press  to set the reading as the relative reference temperature.
- 4** Touch the surface to be measured with the thermocouple probe and read the display.

THIS PAGE HAS BEEN INTENTIONALLY LEFT BLANK.

# 3 Tester Features

Non-Contact AC Voltage Detection (Vsense)	100
Making Relative Measurements (Null)	102
Capturing Maximum and Minimum Values (Max Min)	103
Freezing the Display (TrigHold and AutoHold)	105
Performing Limit Comparisons (Limit)	106
Recording Measurement Data (Log)	108
Reviewing Previously Recorded Data (View)	113

The following sections describe the additional features available in your tester.

## Non-Contact AC Voltage Detection (Vsense)


For model U1461A only: Vsense is a non-contact voltage detector that detects the presence of AC voltages nearby.

### WARNING

- You are advised to test on a known live circuit within the rated AC voltage range of this product before and after each use to ensure that Vsense works.
- Voltage could still be present even if there is no Vsense alert indication. Do not rely on Vsense with shielded wires. Never touch live voltage or conductor without the necessary insulation protection or power off the voltage source.
- Vsense may be affected by differences in socket design, insulation thickness, and insulation type.

### CAUTION



You are advised to measure voltage by using test leads through the voltage measurement function after using Vsense, even if there is no alert indication.

- 1 Press and hold  to enable Vsense (on any position of the rotary switch except **OFF**).

### NOTE

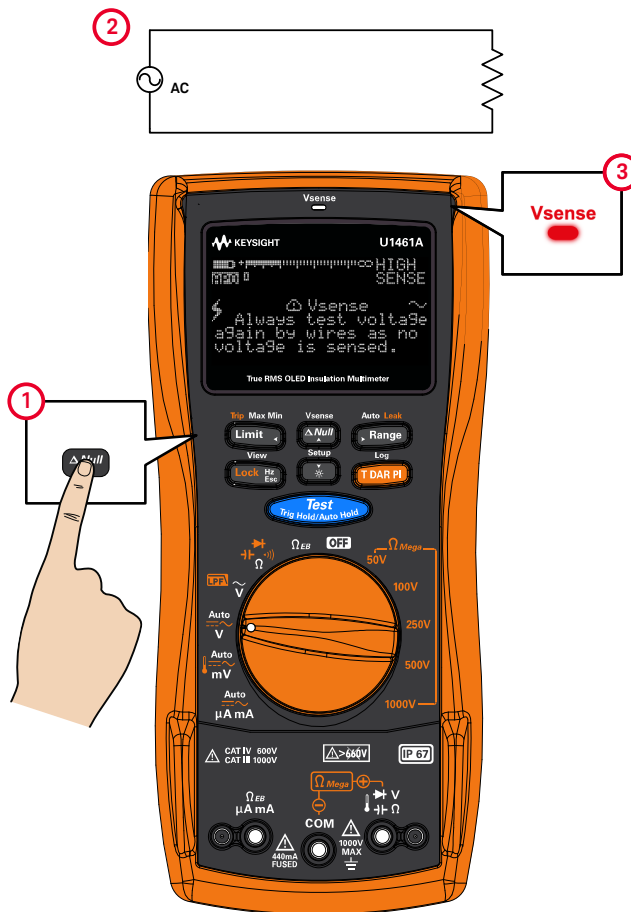
If the presence of AC voltage is sensed, the tester will beep and the Vsense red LED at the top of the tester will turn on. The audible and visual alert allows you to easily sense nearby AC voltage presence.

**No resolution and accuracy of voltage measurement will be displayed in this mode.**

- 2 Press  to toggle the Vsense's sensitivity between **HIGH SENSE** (high sensitivity) or **LOW SENSE** (low sensitivity).
- 3 Press and hold  again to disable Vsense.

**NOTE**

Place the top of the tester close to a conductor when sensing for AC voltages (as low as 24 V in the high sensitivity setting). The high sensitivity setting allows for AC voltage sensing on other styles of recessed power connectors or sockets where the actual AC voltage is recessed within the connector itself. The low sensitivity setting can be used on flush mounted wall sockets or outlets and various power strips or cords.



**Figure 3-1** Detecting AC voltage example

## Making Relative Measurements (Null)




When making null measurements, also called relative, each reading is the difference between a stored (selected or measured) null value and the input signal.


One possible application is to increase the accuracy of a resistance measurement by nulling the test lead resistance.





### NOTE

Null can be set for both auto and manual range settings, but not in the case of an overload.

- 1 To activate Null, press . The measurement value at the time that when Null ( $\Delta$ NULL) is enabled, is stored as the reference value.
- 2 Press  again to view the stored reference value ( $\Delta$ BASE). The display will return to normal after 3 seconds.
- 3 To disable Null, press  while the stored reference value is shown (step 2).

For any measurement function, you can directly measure and store the null value by pressing  with the test leads open (nulls the test lead capacitance), shorted (nulls the test lead resistance), or across a desired null value circuit.

### NOTE

- In resistance measurement, the tester will read a non-zero value even when the two test leads are in direct contact because of the resistance of these leads. Press  to zero-adjust the display.
- For DC voltage measurements, the thermal effect will influence the accuracy of the measurements. Short the test leads and press  when the displayed value is stable to zero-adjust the display.

## Capturing Maximum and Minimum Values (Max Min)

The Max Min operation stores the maximum, minimum, and average input values during a series of measurements.

When the input goes below the recorded minimum value or above the recorded maximum value, the tester beeps and records the new value. The elapsed time since the recording session was started is stored and shown on the display at the same time. The tester also calculates an average of all readings taken since Max Min was activated.


From the tester's display, you can view the following statistical data for any set of readings:

- **REC MAX**: highest reading since Max Min was enabled
- **REC MIN**: lowest reading since Max Min was enabled
- **REC AVG**: average or mean of all readings since Max Min was enabled
- **REC NOW**: present reading (actual input signal value)



- 1 Press and hold **Limit** to enable Max Min.
- 2 Press **Limit** again to cycle through the **MAX**, **MIN**, **AVG**, or **NOW** (present) input values.
- 3 The elapsed time is shown on the display. Press **Test** to restart the recording session.
- 4 Press and hold **Limit** again to disable Max Min.

**NOTE**

- Changing the range manually will also restart the recording session.
  - You can also use Max Min while measuring frequency (see “**Measuring Frequency**” on page 79). If the measured frequency shown is not reflected accurately, press  again to restart the recording session.
  - If an overload is recorded, the averaging function will be stopped. **OL** is shown in place of the average value.
  - The APO (auto power-off) function is disabled when Max Min is enabled.
  - The maximum recording time is 99999 seconds (1 day, 3 hours, 46 minutes, 39 seconds). **OL** is shown if the recording exceeds the maximum time.
- 


Max Min is useful for capturing intermittent readings, recording minimum and maximum readings unattended, or recording readings while equipment operation keeps you from observing the tester display.

The true average value displayed is the arithmetic mean of all readings taken since the start of recording. The average reading is useful for smoothing out unstable inputs, calculating power consumption, or estimating the percentage of time a circuit is active.




## Freezing the Display (TrigHold and AutoHold)

### TrigHold operation


Press  to freeze the display for any function, except for the  $\Omega$  Mega or the  $\Omega$  EB function.



#### NOTE


Pressing  when the rotary switch is in one of the  $\Omega$  Mega or the  $\Omega$  EB position will result in a test being performed instead.

### AutoHold operation

Press and hold  to activate AutoHold for any function, except for the  $\Omega$  Mega or the  $\Omega$  EB function.



#### NOTE

Pressing and holding  when the rotary switch is in one of the  $\Omega$  Mega or the  $\Omega$  EB position will result in a test being performed instead.

AutoHold monitors the input signal and updates the display and, if enabled, emits a beep, whenever a new stable measurement is detected. A trigger point is one that varies more than a selected adjustable (AutoHold threshold) variation count (default 500 counts based on **DDDDD** option selected in Setup). Open lead conditions are not included in the update.

To change the default AutoHold threshold count see [“Changing the variation count”](#) on page 125 for more information.

#### NOTE

If the reading value is unable to reach a stable state, the reading value will not be updated.

## Performing Limit Comparisons (Limit)

Limit is used to compare the test result with the chosen settling value. The default settling values are shown in the table below.







**Table 3-1** Hi/Lo default settling values

Function	Limit settling default value		Limit settling range	
	HI	LO	HI	LO
Voltage measurement	>+30 V	<-30 V	<b>LO</b> to +9999.9 V	-9999.9 V to <b>HI</b>
Voltage measurement (up to millivolts)	>+30 mV	<-30 mV	<b>LO</b> to +999.99 mV	-999.99 mV to <b>HI</b>
Temperature measurement	>+100°	<-100°	<b>LO</b> to +9999.9°	-9999.9° to <b>HI</b>
Resistance measurement	>+10 Ω	<+10 Ω	<b>LO</b> to +99.999 MΩ	-99.999 MΩ to <b>HI</b>
Capacitance measurement	>+10 nF	<+10 nF	<b>LO</b> to +9.9999 mF	-9.9999 mF to <b>HI</b>
Diode test	>+0.8 V	<+0.3 V	<b>LO</b> to +9.9999 V	-9.9999 V to <b>HI</b>
Earth-bond resistance test	>+10 Ω	<+10 Ω	<b>LO</b> to +99.999 kΩ	-99.999 kΩ to <b>HI</b>
Current measurement	>+30 mA	<+0 mA	<b>LO</b> to +999.99 mA	-999.99 mA to <b>HI</b>
Insulation resistance test	>+10 MΩ	<+10 MΩ	<b>LO</b> to +999.99 GΩ	-999.99 GΩ to <b>HI</b>
Frequency measurement	>+999.99 Hz	<+0 Hz	<b>LO</b> to +999.99 kHz	+000.00 Hz to <b>HI</b>
Pulse width measurement	>+000.50 ms	<+0 ms	<b>LO</b> to +9999.9 ms	+000.00 ms to <b>HI</b>
Duty cycle measurement	>+050.00%	<+0%	<b>LO</b> to +999.99%	+000.00% to <b>HI</b>

You can select four different modes for Limit:

Limit mode	GO	NG
<b>LIMIT HI</b> or <b>LIMIT LO</b>	<b>LO</b> limit < Reading < <b>HI</b> limit	Reading < <b>LO</b> limit, or Reading > <b>HI</b> limit
<b>LIMIT H&gt;</b>	Reading > <b>HI</b> limit	Reading ≤ <b>HI</b> limit
<b>LIMIT L&lt;</b>	Reading < <b>LO</b> limit	Reading ≥ <b>LO</b> limit

- 1 Press  to activate Limit.
- 2 Press  again to set the comparison value. Use the arrow keys to position the cursor and to change the value shown.
- 3 Position the cursor on the **HI** symbol to change the Limit mode.
- 4 Press  to save your changes (or press  to discard your changes).
- 5 If the new value is passed:
  - **GO** is shown briefly
  - A short beep tone is heard
- 6 If the new values is failed:
  - For **LIMIT HI** or **LIMIT LO** mode: **HI** or **LO** is shown briefly along with the fail cause
  - For **LIMIT H>** or **LIMIT L<** mode: **NG** is shown briefly
  - Three short beep tones are heard
  - The red LED lights up


#### NOTE

When the Limit feature is enabled for insulation resistance tests, the red LED indicator lights up accordingly to the changes in the limit values instead of blinking every 2 seconds.

## Recording Measurement Data (Log)

Log provides you with the convenience of recording test data for future review or analysis. Since data is stored in the nonvolatile memory, the data remains saved even when the tester is turned OFF or if the battery is replaced.

Log collects measurement information over a user-specified duration. There are three Log options that can be used to capture measurement data: manual (**HAND**), interval (**AUTO**), or event (**TRIG**).

- A manual log stores an instance of the measured signal each time you press and hold  (see [page 109](#)).
- An interval log stores a record of the measured signal at a user-specified interval (see [page 109](#)).
- An event log stores a record of the measured signal each time a trigger condition is satisfied (see [page 110](#)).

**Table 3-2** Log maximum capacity

Log option	Maximum capacity for saving
Manual ( <b>HAND</b> )	100
Interval ( <b>AUTO</b> )	3000
Event ( <b>TRIG</b> )	3000

### NOTE

Each recorded index includes two parameters: the primary display and the secondary display. Examples include IR-V or Hz-V.

Before starting a recording session, set up the tester for the measurements to be recorded.


To change the Log option see [“Changing the recording option”](#) on page 126 for more information.

See [“Reviewing Previously Recorded Data \(View\)”](#) on page 113 to review or erase the recorded entries.


## Performing manual logs (HAND)

Ensure that **HAND** is selected as the Log option in the Setup.

- 1 Press and hold  to store the present input signal value.

 and the log entry number are displayed. The display will return to normal after a short while (around 1 second).

- 2 Repeat [step 1](#) again to save the next input signal value.

The maximum number of readings that can be stored for the manual log is 100 entries. When all entries are occupied, **H : FULL** will be shown when you press and hold .



## Performing interval logs (AUTO)


Ensure that **AUTO** is selected as the Log option in the Setup.


The default recording interval duration is 1 second. To change the recording interval duration, see [“Changing the sample interval duration”](#) on page 126 for more information.

The duration set in the Setup will determine how long each recording interval takes. The input signal value at the end of each interval will be recorded and saved into the tester’s memory.


### Start the interval log mode

- 1 Press and hold  to start interval log mode.


 and the log entry number are displayed. Subsequent readings are automatically recorded into the tester’s memory at the interval specified in the Setup.

- 2 Press and hold  again to exit the interval log mode.



The maximum number of readings that can be stored for the interval log is 3000 entries. When all entries are occupied, **A : FULL** will be shown when you press and hold .

**NOTE**

When the interval log recording session is running, all other keypad operations are disabled; except for , which, when pressed for more than 1 second, will stop and exit the recording session. Furthermore, APO (auto power-off) is disabled during the recording session.

## Performing event logs (TRIG)

Ensure that **TRIG** is selected as the Log option in the Setup.



Event logs are used only with the following modes:

- TrigHold and AutoHold (page 105)
- Max Min recordings (page 103)
- Limit comparisons (page 106)
- Earth-bond resistance tests (page 67)
- Insulation resistance tests (page 67)
- T/DAR/PI tests (page 52)

Event records are triggered by the measured signal satisfying a trigger condition set by the measurement function used in the following modes (shown in Table 3-3 on page 111):




**Table 3-3** Event log trigger conditions


Modes	Trigger condition <i>The input signal value is recorded:</i>	Primary display recorded	Secondary display recorded
TrigHold	Each time you press  and the reading update is stable.	Voltage, current, resistance, capacitance, diode, or frequency	Voltage, current, capacitance cable length, or output source voltage
AutoHold	When the input signal varies more than the variation count and the reading update is stable.	Voltage, current, resistance, capacitance, diode, or frequency	Voltage, current, capacitance cable length, or output source voltage
Max Min	When a new maximum (or minimum) value is recorded. The average and present readings are not recorded in the Event log.	Voltage, current, resistance, capacitance, diode, or frequency	Voltage, current, capacitance cable length, or output source voltage
Limit	Each time a new value is compared ( <b>GO/NG/</b> <b>HI/LO</b> ).	Voltage, current, resistance, capacitance, diode, or frequency	Voltage, current, capacitance cable length, or output source voltage
Earth-bond resistance test Insulation resistance test	Each time you press  to stop the test output source.	Resistance or leak current value	Test output source voltage
T	When the time is up (Timer = 00:00), the final value is recorded before the test output source is stopped.	Resistance or leak current value	Test output source voltage


**NOTE**


The values of DAR t30 (or DAR t15), DAR t60, PI t1, and PI t10 will be recorded in every IR rotary switch location. For more information on DAR and PI tests, see [page 57](#) and [page 58](#).

### Start the event log mode

- 1 Select one of the six modes listed in [Table 3-3](#).
- 2 Press and hold  to start event log mode.

 and the log entry number are displayed. The primary display and secondary display readings will be recorded into the memory. Subsequent readings are automatically recorded into the tester's memory every time the trigger condition specified in [Table 3-3](#) is satisfied.

- 3 Press and hold  again to exit the event log mode.

The maximum number of readings that can be stored for the event log is 3000 entries. When all entries are occupied, **E : FULL** will be shown when you press and hold .

#### NOTE



APO (auto power-off) is disabled during the recording session.

---










## Reviewing Previously Recorded Data (View)

Viewing data stored in the tester's memory is performed through the  key.

- 1 Press and hold  to View the previously recorded data. Press  again to cycle through the manual (**H**), interval (**A**), or event (**E**) records.

If nothing has been recorded, **H : Void**, **A : Void**, or **E : Void** will be displayed instead.


- 2 Select the desired recording category to view its entries.
  - a Press  to jump to the first stored entry. Press  to jump to the last stored entry.
  - b Press  to view the next stored entry. The index number increases by one. Press  to view the previous stored entry. The index number decreases by one.
  - c Press  to clear the last stored entry for the selected log type. Press and hold  to clear all entries for the selected log type.
- 3 Press and hold  again to exit the View mode.



### Sanitizing the Log Memories

You have the option to sanitize the log memories of your tester. This operation erases the log memories of your tester thoroughly. The data stored in the tester's memory will not be able to be reconstructed in any way after the data sanitization operation.



Prior to sanitizing the log memories, ensure that all manual (**H**), interval (**A**), or event (**E**) records have been cleared (see [step c](#)). When all entries are cleared (**H : Void**, **A : Void**, and **E : Void**), press and hold  to sanitize the log memories.

#### CAUTION

The data sanitization operation may take up to 30 seconds to complete. Do not press any keys or turn the rotary switch until the data sanitization operation is completed.

THIS PAGE HAS BEEN INTENTIONALLY LEFT BLANK.

# 4 Setup Options

Using the Setup Menu	116
Setup Menu Summary	118
Setup Menu Items	125

The following sections describe how to change the preset features of your tester.

















## Using the Setup Menu

The Setup menu allows you to change a number of nonvolatile preset features. Modifying these settings affects the general operation of your tester across several functions. Select a setting to edit to perform one of the following actions:

- Switch between two values, such as on or off.
- Cycle through multiple values from a predefined list.
- Decrease or increase a numerical value within a fixed range.

The contents of the Setup menu are summarized in [Table 4-2 on page 118](#).

**Table 4-1** Setup menu key functions

Legend	Description
	<ul style="list-style-type: none"> <li>– Press  for more than 1 second to access the Setup menu.</li> <li>– Press and hold  until the tester restarts to exit the Setup menu.</li> </ul>
	<ul style="list-style-type: none"> <li>– Arrow keys left and right</li> <li>– Press  or  to browse each menu page.</li> </ul>
	<ul style="list-style-type: none"> <li>– Arrow keys up and down</li> <li>– Press  or  at each menu page to move the cursor to a specific menu item.</li> </ul>
	<ul style="list-style-type: none"> <li>– Press  to edit the selected menu item. The menu item's value will flash to indicate that you can now change the value shown.</li> <li>– Press  or  again to switch between two values, to cycle through multiple values from a list, or to decrease or increase a numerical value.</li> <li>– Press  to save your changes.</li> </ul>
	<ul style="list-style-type: none"> <li>– While the menu item's value is flashing, press  to discard your changes.</li> </ul>

### NOTE

The tester will automatically exit the Setup menu after 30 seconds of inactivity.

## Editing numerical values

When editing numerical values, use the **Limit** and **Range** to position the cursor on a numerical digit.

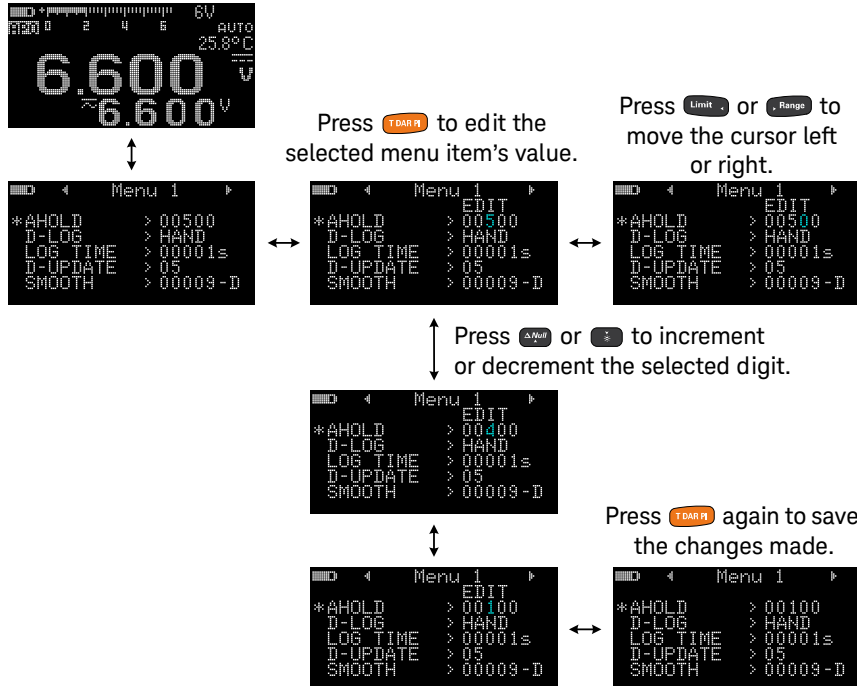
- Press **Limit** to move the cursor to the left, and
- Press **Range** to move the cursor to the right.

When the cursor is positioned over a digit, use the **Δ/Null** and **\*/** keys to change the numerical digit.

- Press **Δ/Null** to increment the digit, and
- Press **\*/** to decrement the digit.

When you have completed your changes, save the new numerical value by pressing **T/DAR/PI**. (Or alternatively, if you wish to discard the changes you made, press **Lock/Hz/Enc**.)

Press and hold **↵** for more than 1 second to enter the Setup menu.



## Setup Menu Summary

The Setup menu items are summarized in the table below. Click the respective “Learn more” pages for more information on each menu item.

**Table 4-2** Setup menu item descriptions

Menu	Legend	Available settings	Description	Learn more on:
MENU 1	AHOLD	00500 to 99999	Set the AutoHold threshold count from 5 to 99999 counts (or 9999 counts, depending on the display count selected). Default is 500 counts.	<a href="#">page 125</a>
	D-LOG	HAND, AUTO, or TRIG	Set the data logging option (HAND: manual log, AUTO: interval log, or TRIG: event log). Default is manual log.	<a href="#">page 126</a>
	LOG TIME	00001 S to 99999 S	Set the logging duration for interval logs from 1 to 99999 seconds (1 day, 3 hours, 46 minutes, 39 seconds). Default is 1 second.	<a href="#">page 126</a>
	D-UPDATE	05, 10, 20, or 40 times per second	Set the data update rate for voltage, current, resistance, and diode measurements. Default is 5 times per second.	<a href="#">page 127</a>
	SMOOTH	00001 to 99999 (D or E)	Set the settling value from 00001 to 99999. You can also disable this feature (D). Default is disabled (00009-D).	<a href="#">page 128</a>

**Table 4-2** Setup menu item descriptions (continued)

Menu	Legend	Available settings	Description	Learn more on:
MENU 2	DMM COUNTS	DDDDD or DDDD	Set the voltage, current, and frequency display count. Default is DDDD	<a href="#">page 130</a>
	Cx COUNTS	DDDDD, DDDD, or DDD	Set the capacitance display count. Default is DDDD	<a href="#">page 130</a>
	Rx COUNTS	DDDDD, DDDD, or DDD	Set the resistance display count. Default is DDDD	<a href="#">page 130</a>
	EBR COUNTS	DDDD or DDD	Set the earth-bond resistance display count. Default is DDDD	<a href="#">page 130</a>
	IR COUNTS	DDDD or DDD	Set the insulation resistance display count. Default is DDD	<a href="#">page 130</a>
MENU 3	BEEP	3200 Hz to 4267 Hz, or OFF	Set the beep frequency from 3200 Hz to 4267 Hz. You can also disable this feature (off). Default is 3840 Hz.	<a href="#">page 131</a>
	APO	01 m to 99 m (E or D)	Set the auto power-off timer period from 1 to 99 minutes (1 hour, 39 minutes). You can also disable this feature (D). Default is 10 minutes (10 m-E).	<a href="#">page 132</a>
	BACKLIT	LOW, MEDIUM, HIGH, or AUTO-(01 to 99)	Set the default OLED behavior from low to high. You can also set the OLED to auto-dim (AUTO) and change the auto-dim settling time (1 to 99 seconds). Default is auto-dim (AUTO-90).	<a href="#">page 132</a>
	MELODY	FACTORY, USER, BEEE, or OFF	Set the power-on melody to the factory default, a beep, or disable this feature (off). Default is BEEE.	<a href="#">page 133</a>
	GREETING	FACTORY, USER, or OFF	Set the power-on greetings to the factory default or disable this feature (off). Default is FACTORY.	<a href="#">page 134</a>

**Table 4-2** Setup menu item descriptions (continued)

Menu	Legend	Available settings	Description	Learn more on:
	BAUD	9600 or 19200	Set the baud rate for remote communication with a PC (9600 or 19200). Default is 9600.	<a href="#">page 135</a>
	DATA BIT	7 or 8	Set the data bit length for remote communication with a PC (7-bit or 8-bit). Default is 8-bit.	<a href="#">page 136</a>
MENU 4	PARITY	NONE, EVEN, or ODD	Set the parity bit for remote communication with a PC (none, even, or odd). Default is none.	<a href="#">page 136</a>
	ECHO	OFF or ON	Set the tester to echo (return) all the characters it receives. Default is disabled (off).	<a href="#">page 137</a>
	PRINT	OFF or ON	Set the tester to print out the measured data when the measuring cycle is completed. Default is disabled (off).	<a href="#">page 137</a>



**Table 4-2** Setup menu item descriptions (continued)

Menu	Legend	Available settings	Description	Learn more on:
MENU 5	REVISION	-	Displays the tester's firmware revision.	-
	S/N	-	Displays the tester's serial number (only the last eight digits).	-
	DUAL DC+AC	YES or NO	Enable dual display for voltage and current measurements. (AC+DC measurements are shown on the secondary display.) Default is yes.	<a href="#">page 139</a>
	ALERT HORN	BEE&LED, OFF&LED, BEE&OFF, OFF&OFF	Set the tester to beep momentarily and light up the red LED indicator for limit and continuity alerts. You can also disable either or both alerts (off). Default is to beep momentarily and light up the red LED indicator (BEE&LED).	<a href="#">page 140</a>
	CONTINUITY	SHORT, OPEN, or TONE (E or D)	Set the tester to sound a single beep or a tone during continuity alerts for short or open circuits. You can also disable this feature (D). Default is a single beep for short circuits (SHORT-E).	<a href="#">page 140</a>

**Table 4-2** Setup menu item descriptions (continued)

Menu	Legend	Available settings	Description	Learn more on:
MENU 6	DEFAULT	YES or NO	Reset the tester to its factory default settings.	<a href="#">page 142</a>
	BATTERY	PRI or SEC	Change the battery selection from primary to secondary. Default is primary.	<a href="#">page 142</a>
	MIN-Hz	0.5 Hz or 10 Hz	Set the minimum measurement frequency (0.5 Hz or 10 Hz). Default is 0.5 Hz.	<a href="#">page 143</a>
	CABLE km/C	1 nF/km to 99 nF/km (E or D)	Set the capacitance measurement versus cable length scale from 1 to 99 nF/km. You can also disable this feature (D). Default is 40 nF/km (40nF-E).	<a href="#">page 143</a>
	CL-UNIT	Meter (m) or Foot (ft)	Set the cable length unit (Meter or Foot) for capacitance measurements. Default is Meter (m).	<a href="#">page 144</a>
MENU 7	mV INPUT	10 M $\Omega$ or >1 G $\Omega$	Set the input impedance for mV measurements. Default is 10 M $\Omega$ .	<a href="#">page 145</a>
	REMOTE KEY	K1 to K7 (D or E)	Change or disable the button operation on the remote probe. Default is  (K7-E).	<a href="#">page 146</a>
	LOCK ONCE	YES or NO	Enable or disable the lock once feature. Default is enabled (YES).	<a href="#">page 147</a>
	INHIBIT V	30 V, 50 V or 75 V	Set the maximum inhibit voltage for insulation resistance test. Default is 30 V.	<a href="#">page 147</a>
	DAR TIME	60:30 or 60:15 (seconds)	Set the Dielectric Absorption Ratio in seconds (60:30 or 60:15). Default is 60:30 (seconds).	<a href="#">page 148</a>

**Table 4-2** Setup menu item descriptions (continued)

Menu	Legend	Available settings	Description	Learn more on:
MENU 8	IR: 50 V	F 50 V or U (10 to 60) V	Set the insulation resistance test voltage to the factory default or user-defined. Default is factory.	<a href="#">page 149</a>
	IR: 100 V	F 100 V or U (10 to 120) V		
	IR: 250 V	F 250 V or U (10 to 300) V		
	IR: 500 V	F 500 V or U (10 to 600) V		
	IR: 1000 V	F 1000 V or U (10 to 1100) V		
MENU 9	TEST TIME	00:05 to 59:59	Set the insulation resistance or earth-bond resistance test period. Default is 1 minute (01:00)	<a href="#">page 151</a>
	SCAN TIME	1 to 99 (seconds)	Set the dwelling time for each step in the Scan function. Default is 10 seconds.	<a href="#">page 151</a>
	SCAN STEP	001 to 100	Set the number of steps for the Scan function. Default is 5 steps.	<a href="#">page 152</a>
	RAMP STEP	0001 to 1000	Set the number of steps for the Ramp function. Default is 100 steps.	<a href="#">page 153</a>
	TRIP mA	0.001 mA to 1.500 mA	Set the trip current level. Default is 1.000 mA.	<a href="#">page 153</a>

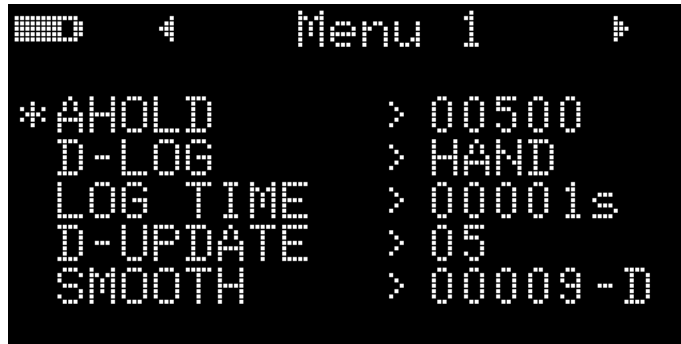
**Table 4-2** Setup menu item descriptions (continued)

Menu	Legend	Available settings	Description	Learn more on:
MENU 10 <sup>[a]</sup>	T-TYPE	J or K	Set the thermocouple type (type J or type K) for temperature measurements. Default is type K.	<a href="#">page 155</a>
	T-UNIT	°C, °F/°C, °C/°F, or °F	Set the temperature unit (Celsius, Fahrenheit/ Celsius, Celsius/Fahrenheit, or Fahrenheit) for temperature measurements. Default is °C (Celsius).	<a href="#">page 155</a>
	LPF	ON or OFF	Enable the low-pass filter to filter out higher frequencies with (AC/DC path) V, mV, $\mu$ A, or mA measurements. Default is off.	<a href="#">page 156</a>
	mA SCALE	0-20 mA or 4-20 mA (D or E)	Set the % scale selection (0-20 mA or 4-20 mA) for DC current measurements. You can also disable this feature (D). Default is disabled (4-20mA-D).	<a href="#">page 157</a>
	% & ms	+CYCLE-D	Set + or – cycle for duty cycle and pulse width measurements. You can also disable this feature (D). Default is disabled (+CYCLE-D).	<a href="#">page 157</a>
MENU 11 <sup>[a]</sup>	LEAD ALERT	NONE, USER, or AUTO	Set the beep type for the lead alert.	

[a] Model U1453A and U1461A only.

## Setup Menu Items

### Menu 1








#### Changing the variation count

Menu Items	Learn more on:
AHOLD	<a href="#">"Changing the variation count"</a> on page 125
D-LOG	<a href="#">"Changing the recording option"</a> on page 126
LOG TIME	<a href="#">"Changing the sample interval duration"</a> on page 126
D-UPDATE	<a href="#">"Changing the data update rate"</a> on page 127
SMOOTH	<a href="#">"Enabling smooth mode"</a> on page 128

This setting is used with the AutoHold feature (see [page 105](#)). When the variation of the measured value exceeds the value of the variation count, the AutoHold feature will be ready to trigger.

Parameter	Range	Default setting
AHOLD	(5 to 99999) counts	00500

To change the variation count:

- 1 Press  for more than 1 second to enter the Setup menu.
- 2 Browse to **Menu 1 > AHOLD**, and press  to edit the value.
- 3 Use the arrow keys to change the variation count.
- 4 Press  to save your changes (or press  to discard your changes).
- 5 Press and hold  until the tester restarts to return to normal operation.






### Changing the recording option

This setting is used with the Data Logging feature (see [page 108](#)). There are three available recording options for the Data Logging feature.

- HAND: Manual log
- AUTO: Interval log
- TRIG: Event log

Parameter	Range	Default setting
D-LOG	HAND, AUTO, or TRIG	HAND

To change the recording option:






- 1 Press  for more than 1 second to enter the Setup menu.
- 2 Browse to **Menu 1 > D-LOG**, and press  to edit the value.
- 3 Use the arrow keys to change the recording option.
- 4 Press  to save your changes (or press  to discard your changes).
- 5 Press and hold  until the tester restarts to return to normal operation.

### Changing the sample interval duration

This setting is used with the Interval Data Logging feature (see [page 109](#)). The tester will record a measurement value at the beginning of every sample interval.

Parameter	Range	Default setting
LOG TIME	(1 to 99999) s	00001 S

To change the sample interval duration:






- 1 Press  for more than 1 second to enter the Setup menu.
- 2 Browse to **Menu 1 > LOG TIME**, and press  to edit the value.
- 3 Use the arrow keys to change the sample interval duration.
- 4 Press  to save your changes (or press  to discard your changes).
- 5 Press and hold  until the tester restarts to return to normal operation.

### Changing the data update rate

This setting is used to increase the data update rate for voltage, current, resistance, and diode measurements.

Parameter	Range	Default setting
D-UPDATE	5, 10, 20, or 40 times per second	5 times per second


To change the data update rate:

- 1 Press  for more than 1 second to enter the Setup menu.
- 2 Browse to **Menu 1 > D-UPDATE**, and press  to edit the value.
- 3 Use the arrow keys to change the data update rate.
- 4 Press  to save your changes (or press  to discard your changes).
- 5 Press and hold  until the tester restarts to return to normal operation.

## Enabling smooth mode






Smooth is used to smoothen the refresh rate of the readings in order to reduce the impact of unexpected noise and to help you achieve a stable reading.

The smooth refresh rate can be set from 00001 to 99999. The smooth time is defined as the set value +1. Smooth will be restarted when the variation count is exceeded, when the range is changed, or after a tester function or feature is enabled. The variation count is set to the value used for the AutoHold feature (see “[Changing the variation count](#)” on page 125).

You can enable Smooth by holding  while turning on the tester (“[Your Tester in Brief](#)” on page 28). This method, however, is temporary and Smooth will be turned off when you cycle the tester’s power. You can permanently enable Smooth from the Setup menu.

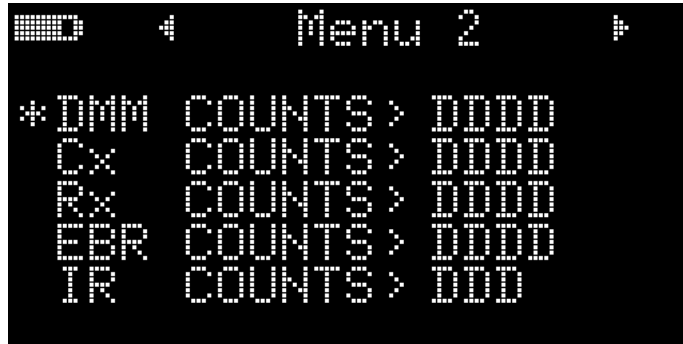
Parameter	Range	Default setting
SMOOTH	- 00001 to 99999 - D(isabled) or E(nabled)	0009-D(isabled)

To change the smooth refresh rate:

- 1 Press  for more than 1 second to enter the Setup menu.
- 2 Browse to **Menu 1 > SMOOTH**, and press  to edit the value.
- 3 Use the arrow keys to change the smooth refresh rate. Select **E** to enable the Smooth feature.
- 4 Press  to save your changes (or press  to discard your changes).
- 5 Press and hold  until the tester restarts to return to normal operation.



## Menu 2



Menu Items	Learn more on:
DMM	
Cx	
Rx	<a href="#">"Changing the display count" on page 130</a>
EBR	
IR	

## Changing the display count

Use these settings to change the display count for the following measurements/ tests.

Parameter	Affects	Range <sup>[a]</sup>		
		DDDDD	DDDD	DDD
DMM	Voltage, current <sup>[b]</sup> , and frequency measurements	66000/99999	6600/9999	-
Cx	Capacitance measurements	12000	1200	120
Rx	Resistance measurements	66000	6600	660
EBR	Earth-bond resistance measurements	-	6600	660
IR	Insulation resistance measurements	-	6600	660






[a] Default range is bolded.

[b] Model U1461A only.

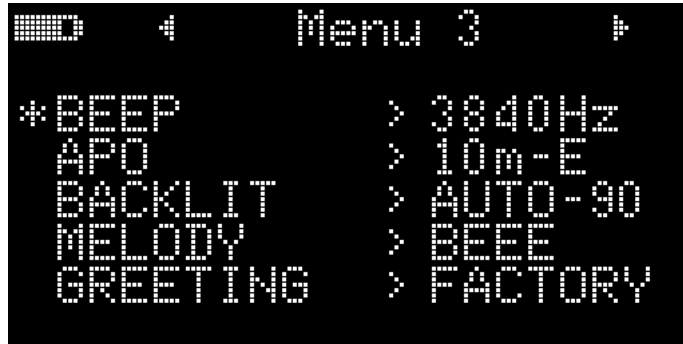
### NOTE

DAR and PI indications are fixed at 9999 counts.

To change the display count:

- 1 Press  for more than 1 second to enter the Setup menu.
- 2 Browse to **Menu 2**, select the desired measurement display count (**DMM**, **Cx**, **Rx**, **EBR**, or **IR**) and press  to edit the value.
- 3 Use the arrow keys to change the display count.
- 4 Press  to save your changes (or press  to discard your changes).
- 5 Press and hold  until the tester restarts to return to normal operation.

## Menu 3





Menu Items	Learn more on:
BEEP	<a href="#">"Changing the beep frequency"</a> on page 131
APO	<a href="#">"Changing the auto power-off (APO) timer"</a> on page 132
BACKLIT	<a href="#">"Changing the OLED behavior"</a> on page 132
MELODY	<a href="#">"Disabling the power-on melody"</a> on page 133
GREETING	<a href="#">"Disabling the power-on greeting"</a> on page 134




### Changing the beep frequency

The beeper alerts users to the presence of circuit continuities and newly sensed values for Max Min recordings.

Parameter	Range	Default setting
BEEP	4267, 4151, 4042, 3938, 3840, 3746, 3675, 3572, 3491, 3413, 3339, 3268, 3200 (Hz), or OFF	3840 Hz

To change the beep frequency:

- 1 Press  for more than 1 second to enter the Setup menu.
- 2 Browse to **Menu 3** > **BEEP**, and press  to edit the value.






- 3 Use the arrow keys to change the beep frequency. Select **OFF** to disable the beeper.
- 4 Press  to save your changes (or press  to discard your changes).
- 5 Press and hold  until the tester restarts to return to normal operation.

### Changing the auto power-off (APO) timer

The APO (see [page 24](#)) feature uses a timer to determine when to automatically turn the tester off.

Parameter	Range	Default setting
APO	- (1 to 99) minutes - E(nabled) or D(isabled)	10 M-E

To change the APO timer period:






- 1 Press  for more than 1 second to enter the Setup menu.
- 2 Browse to **Menu 3 > APO**, and press  to edit the value.
- 3 Use the arrow keys to change the APO timer period. Select **D** to disable the APO feature.
- 4 Press  to save your changes (or press  to discard your changes).
- 5 Press and hold  until the tester restarts to return to normal operation.

### Changing the OLED behavior

The OLED is set to auto-dim by default. However, you can manually control the OLED brightness by changing the values in this Setup item.

Parameter	Range	Default setting
BACKLIT	LOW, MEDIUM, HIGH, or AUTO-NN	AUTO-90

To change the OLED behavior:



- 1 Press  for more than 1 second to enter the Setup menu.
- 2 Browse to **Menu 3 > BACKLIT**, and press  to edit the value.
- 3 Use the arrow keys to change the OLED behavior.
- 4 If you select **AUTO** (to enable the auto-dim feature), you can also use the arrow keys to change the auto-dim settling time. The display will auto-dim after (1 to 99 seconds) depending on the value selected.
- 5 Press  to save your changes (or press  to discard your changes).
- 6 Press and hold  until the tester restarts to return to normal operation.

### Disabling the power-on melody

The tester plays a melody or a beep when it is powered on.




Parameter	Range	Default setting
MELODY	FACTORY, USER, BEEE, or OFF	BEEE

To disable the power-on melody:

- 1 Press  for more than 1 second to enter the Setup menu.
- 2 Browse to **Menu 3 > MELODY**, and press  to edit the value.
- 3 Use the arrow keys to change the power-on melody. Select **OFF** to disable the power-on melody.

#### NOTE

The **USER** option is reserved for Keysight internal use.



- 4 Press  to save your changes (or press  to discard your changes).
- 5 Press and hold  until the tester restarts to return to normal operation.

## Disabling the power-on greeting

The tester displays the Keysight logo when it is powered on.




Parameter	Range	Default setting
GREETING	FACTORY, USER, or OFF	FACTORY

To disable the power on greeting:

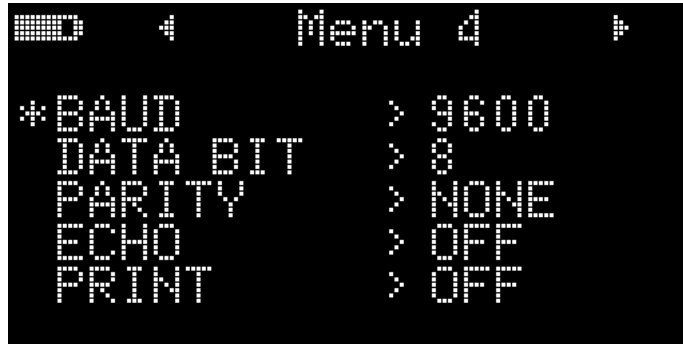
- 1 Press  for more than 1 second to enter the Setup menu.
- 2 Browse to **Menu 3 > GREETING**, and press  to edit the value.
- 3 Use the arrow keys to change the power-on greeting. Select **OFF** to disable the power-on greeting.

### NOTE

The **USER** option is reserved for Keysight internal use.

- 4 Press  to save your changes (or press  to discard your changes).
- 5 Press and hold  until the tester restarts to return to normal operation.

## Menu 4





Menu Items	Learn more on:
BAUD	<a href="#">“Changing the baud rate”</a> on page 135
DATA BIT	<a href="#">“Changing the data bits”</a> on page 136
PARITY	<a href="#">“Changing the parity check”</a> on page 136
ECHO	<a href="#">“Enabling the echo feature”</a> on page 137
PRINT	<a href="#">“Enabling the print feature”</a> on page 137




### Changing the baud rate

This setting changes the baud rate for remote communications with a PC.

Parameter	Range	Default setting
BAUD	(9600 or 19200) bits/second	9600

To change the baud rate:

- 1 Press  for more than 1 second to enter the Setup menu.
- 2 Browse to **Menu 4 > BAUD**, and press  to edit the value.






- 3 Use the arrow keys to change the baud rate.
- 4 Press  to save your changes (or press  to discard your changes).
- 5 Press and hold  until the tester restarts to return to normal operation.

### Changing the data bits

This setting changes the number of data bits (data width) for remote communications with a PC. The number of stop bit is always 1, and this cannot be changed.

Parameter	Range	Default setting
DATA BIT	8-bit or 7-bit	8

To change the data bit:



- 1 Press  for more than 1 second to enter the Setup menu.
- 2 Browse to **Menu 4 > DATA BIT**, and press  to edit the value.
- 3 Use the arrow keys to change the data bit.
- 4 Press  to save your changes (or press  to discard your changes).
- 5 Press and hold  until the tester restarts to return to normal operation.

### Changing the parity check




This setting changes the parity check for remote communications with a PC.

Parameter	Range	Default setting
PARITY	NONE, EVEN, or ODD	NONE

To change the parity check:

- 1 Press  for more than 1 second to enter the Setup menu.
- 2 Browse to **Menu 4 > PARITY**, and press  to edit the value.
- 3 Use the arrow keys to change the parity check.








- 4 Press  to save your changes (or press  to discard your changes).
- 5 Press and hold  until the tester restarts to return to normal operation.

### Enabling the echo feature

When the echo feature is enabled, the tester echoes (returns) all the characters it receives when it is connected to a remote PC.

Parameter	Range	Default setting
ECHO	OFF or ON	OFF

To enable the echo feature:

- 1 Press  for more than 1 second to enter the Setup menu.
- 2 Browse to **Menu 4 > ECHO**, and press  to edit the value.
- 3 Use the arrow keys to enable the echo feature.
- 4 Press  to save your changes (or press  to discard your changes).
- 5 Press and hold  until the tester restarts to return to normal operation.






### Enabling the print feature

When the print feature is enabled, the tester will print out the measured data when the measuring cycle is complete. The tester will automatically send new data to the remote PC host continuously. The tester does not accept any commands from the PC host when this feature is enabled.

Parameter	Range	Default setting
PRINT	OFF or ON	OFF

## 4 Setup Options

To enable the print feature:

- 1 Press  for more than 1 second to enter the Setup menu.
- 2 Browse to **Menu 4 > PRINT**, and press  to edit the value.
- 3 Use the arrow keys to enable the print feature.
- 4 Press  to save your changes (or press  to discard your changes).
- 5 Press and hold  until the tester restarts to return to normal operation.

## Menu 5

```

Menu 5
*REVISION      > 01.00
S/N           > 12731688
DUAL DC+AC    > YES
ALERT HORN    > BEE&LED
CONTINUITY    > SHORT-E

```






Menu Items	Learn more on:
REVISION	-
S/N	-
DUAL DC+AC	<a href="#">“Enabling dual display for voltage and current measurements”</a> on page 139
ALERT HORN	<a href="#">“Changing the alert indicators”</a> on page 140
CONTINUITY	<a href="#">“Changing the continuity alert”</a> on page 140

### Enabling dual display for voltage and current measurements

This setting is used to enable dual display for voltage and current measurements. The AC+DC measurement will be shown on the secondary display.

Parameter	Range	Default setting
DUAL DC+AC	YES or NO	YES

To enable dual display:






- 1 Press  for more than 1 second to enter the Setup menu.
- 2 Browse to **Menu 5 > DUAL DC+AC**, and press  to edit the value. Select **NO** to disable the dual display.
- 3 Use the arrow keys to enable the dual display.
- 4 Press  to save your changes (or press  to discard your changes).
- 5 Press and hold  until the tester restarts to return to normal operation.

### Changing the alert indicators

The tester's audible and visual alerts users to the presence of circuit continuities (see [page 84](#)) and values exceeding the Limit values set (see [page 84](#)).

Parameter	Range	Default setting
ALERT HORN	BEE&LED, OFF&LED, BEE&OFF, OFF&OFF	BEE&LED

To change the alert indicators:






- 1 Press  for more than 1 second to enter the Setup menu.
- 2 Browse to **Menu 5 > ALERT HORN**, and press  to edit the value.
- 3 Use the arrow keys to change the alert indicators. Select **OFF** to disable either the beeper, the red LED, or both alert indicators.
- 4 Press  to save your changes (or press  to discard your changes).
- 5 Press and hold  until the tester restarts to return to normal operation.

### Changing the continuity alert

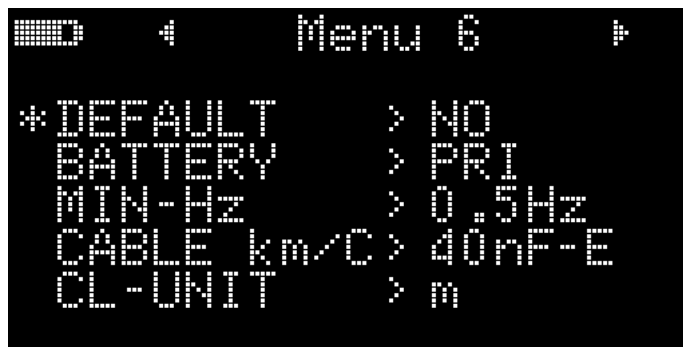
This setting is used with continuity tests (see [page 84](#)). The tester will beep to alert users to the presence of circuit continuities for short or open circuits.

Parameter	Range	Default setting
CONTINUITY	<ul style="list-style-type: none"> <li>- SHORT, OPEN, or TONE</li> <li>- D(isabled) or E(nabled)</li> </ul>	SHORT-E

To change the continuity alert:

- 1 Press  for more than 1 second to enter the Setup menu.
- 2 Browse to **Menu 5 > CONTINUITY**, and press  to edit the value.
- 3 Use the arrow keys to change the continuity alert. Select **D** to disable the continuity alert for either the **SHORT**, **OPEN**, or **TONE** alerts.
- 4 Press  to save your changes (or press  to discard your changes).
- 5 Press and hold  until the tester restarts to return to normal operation.

## Menu 6







Menu Items	Learn more on:
DEFAULT	<a href="#">"Resetting the tester's Setup options"</a> on page 142
BATTERY	<a href="#">"Changing the battery type"</a> on page 142
MIN-Hz	<a href="#">"Changing the minimum measurable frequency"</a> on page 143

Menu Items	Learn more on:
CABLE km/C	<a href="#">“Changing the cable length scale”</a> on page 143
CL-UNIT	<a href="#">“Changing the cable length unit”</a> on page 144

### Resetting the tester’s Setup options

The tester’s Setup options can be reset to its default values through the Setup menu.

Parameter	Range	Default setting
DEFAULT	YES or NO	NO



- 1 Press  for more than 1 second to enter the Setup menu.
- 2 Browse to **Menu 6 > DEFAULT**, and press  to edit the value.
- 3 Use the arrow keys to select **YES**.
- 4 Press and hold  for more than 1 second to perform the reset. The tester will beep once and return to the first Setup menu page. Or, alternatively press  to discard your changes.




### Changing the battery type

If you are using rechargeable batteries to power your tester, change the battery type from **PRI** to **SEC** for the tester to accurately reflect the battery capacity indication.

Parameter	Range	Default setting
BATTERY	PRI or SEC	PRI

To change the battery type:

- 1 Press  for more than 1 second to enter the Setup menu.
- 2 Browse to **Menu 6 > BATTERY**, and press  to edit the value.






- 3 Use the arrow keys to change the battery type.
- 4 Press  to save your changes (or press  to discard your changes).
- 5 Press and hold  until the tester restarts to return to normal operation.

### Changing the minimum measurable frequency

This setting is used with frequency tests (see [page 79](#)). Changing the minimum measurable frequency will influence the measurement rates for frequency, duty cycle, and pulse width measurements. The typical measurement rate as defined in the specification is based on a minimum measurable frequency of 10 Hz.

Parameter	Range	Default setting
MIN-Hz	0.5 Hz or 10 Hz	0.5 Hz

To change the minimum measurable frequency:






- 1 Press  for more than 1 second to enter the Setup menu.
- 2 Browse to **Menu 6 > MIN-Hz**, and press  to edit the value.
- 3 Use the arrow keys to change the minimum measurable frequency.
- 4 Press  to save your changes (or press  to discard your changes).
- 5 Press and hold  until the tester restarts to return to normal operation.

### Changing the cable length scale

This setting is used with capacitance measurements (see [page 91](#)). Change the unit (Meter or Feet) of the cable length display.

Parameter	Range	Default setting
CABLE km/C	- (1 to 99) nF - D(isabled) or E(nabled)	40 nF-E

To change the cable length scale:






- 1 Press  for more than 1 second to enter the Setup menu.
- 2 Browse to **Menu 6 > CABLE km/C** and press  to edit the value.
- 3 Use the arrow keys to change the cable length scale. Select **D** to disable the cable length display in capacitance measurements.
- 4 Press  to save your changes (or press  to discard your changes).
- 5 Press and hold  until the tester restarts to return to normal operation.

### Changing the cable length unit

This setting is used with capacitance measurements (see [page 91](#)). Change the scale from 1 nF to 99 nF per kilometer for capacitance transfers to cable length.

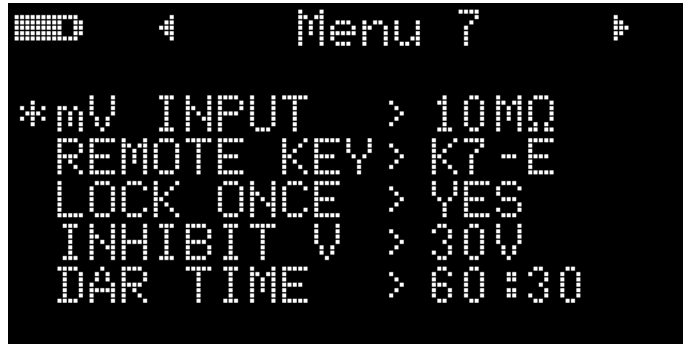
Parameter	Range	Default setting
CL-UNIT	m (Meter) or ft (Feet)	m (Meter)

To change the cable length unit:

- 1 Press  for more than 1 second to enter the Setup menu.
- 2 Browse to **Menu 6 > CL-UNIT** and press  to edit the value.
- 3 Use the arrow keys to change the cable length unit.
- 4 Press  to save your changes (or press  to discard your changes).
- 5 Press and hold  until the tester restarts to return to normal operation.



## Menu 7








Menu Items	Learn more on:
mV INPUT	<a href="#">“Changing the input impedance for mV measurements”</a> on page 145
REMOTE KEY	<a href="#">“Changing the button operation on the remote switch probe”</a> on page 146
LOCK ONCE	<a href="#">“Disabling the lock once feature”</a> on page 147
INHIBIT V	<a href="#">“Changing the maximum inhibit voltage for insulation resistance tests”</a> on page 147
DAR TIME	<a href="#">“Changing the Dielectric Absorption Ratio (DAR) for insulation resistance tests”</a> on page 148

### Changing the input impedance for mV measurements

This setting is used with voltage measurements, up to millivolts (see [page 52](#)). Select an appropriate input impedance value according to your requirements.

Parameter	Range	Default setting
mV INPUT	10 M $\Omega$ or >1 G $\Omega$	10 M $\Omega$

To change the input impedance for mV measurements:






- 1 Press  for more than 1 second to enter the Setup menu.
- 2 Browse to **Menu 7 > mV INPUT**, and press  to edit the value.
- 3 Use the arrow keys to change the input impedance value.
- 4 Press  to save your changes (or press  to discard your changes).
- 5 Press and hold  until the tester restarts to return to normal operation.

### Changing the button operation on the remote switch probe


This setting is used with the remote switch probe. The button operation on the remote switch probe will emulate the function selected in this setting.


Parameter	Range	Default setting
REMOTE KEY	- K1 - 	K7 - E
	- K2 - 	
	- K3 - 	
	- K4 - 	
	- K5 - 	
	- K6 - 	
	- K7 - 	
	- D(isable) or E(nable)	

To change the button operation on the remote switch probe:

- 1 Press  for more than 1 second to enter the Setup menu.
- 2 Browse to **Menu 7 > REMOTE KEY**, and press  to edit the value.
- 3 Use the arrow keys to change the function of the remote switch probe button. Select **D** to disable the remote switch probe button.
- 4 Press  to save your changes (or press  to discard your changes).
- 5 Press and hold  until the tester restarts to return to normal operation.






## Disabling the lock once feature

This setting is used with insulation resistance tests (see [page 67](#)) and earth-bond resistance measurements (see [page 67](#)). By default, the tester will reset the locked status when the test is stopped by pressing .

If you disable this feature, you will need to press  to unlock the tester, even if the test has already stopped.

Parameter	Range	Default setting
LOCK ONCE	YES or NO	YES

To disable the lock once feature:



- 1 Press  for more than 1 second to enter the Setup menu.
- 2 Browse to **Menu 7 > LOCK ONCE**, and press  to edit the value.
- 3 Use the arrow keys to select **NO**.
- 4 Press  to save your changes (or press  to discard your changes).
- 5 Press and hold  until the tester restarts to return to normal operation.




## Changing the maximum inhibit voltage for insulation resistance tests

This setting is used with insulation resistance tests (see [page 67](#)). The tester will not perform the insulation resistance test if it detects that the external voltage exceeds the inhibit voltage value set here.

Parameter	Range	Default setting
INHIBIT V	30 V, 50 V, or 75 V	75 V

To change the maximum inhibit voltage:

- 1 Press  for more than 1 second to enter the Setup menu.
- 2 Browse to **Menu 7 > INHIBIT V**, and press  to edit the value.






- 3 Use the arrow keys to change the value of the inhibit voltage.
- 4 Press  to save your changes (or press  to discard your changes).
- 5 Press and hold  until the tester restarts to return to normal operation.

### Changing the Dielectric Absorption Ratio (DAR) for insulation resistance tests

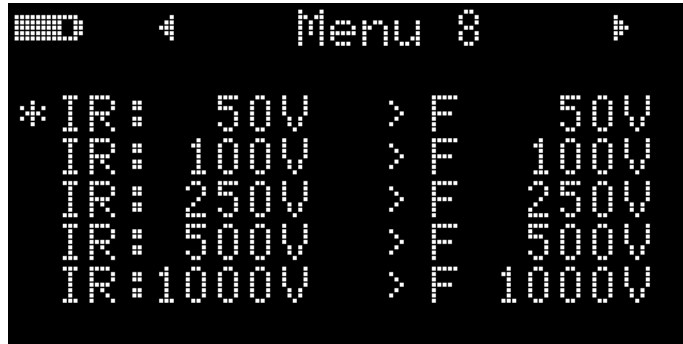
This setting is used with insulation resistance tests (see [page 67](#)). The tester performs the DAR test using the ratio set here.

Parameter	Range	Default setting
DAR TIME	60:30 or 60:15 (seconds)	60:30 (seconds)

To change the DAR ratio:

- 1 Press  for more than 1 second to enter the Setup menu.
- 2 Browse to **Menu 7 > DAR TIME**, and press  to edit the value.
- 3 Use the arrow keys to change the value of the DAR ratio.
- 4 Press  to save your changes (or press  to discard your changes).
- 5 Press and hold  until the tester restarts to return to normal operation.

## Menu 8



Menu Items	Learn more on:
IR: 50 V	
IR: 100 V	
IR: 250 V	<a href="#">"Changing the insulation resistance test voltage"</a> on page 149
IR: 500 V	
IR: 1000 V	

### Changing the insulation resistance test voltage

This setting is used with insulation resistance tests (see [page 67](#)). Select **U**(ser) to manually change the test voltage value for insulation resistance tests.






Parameter	Range	
	F(actory)	U(ser) <sup>[a]</sup>
IR: 50 V	50 V	10 V to 60 V
IR: 100 V	100 V	10 V to 120 V
IR: 250 V	250 V	10 V to 300 V

## 4 Setup Options

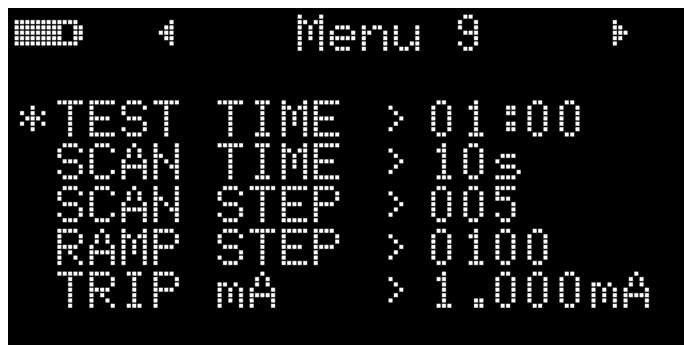
Parameter	Range	
	F(factory)	U(ser) <sup>[a]</sup>
IR: 500 V	500 V	10 V to 600 V
IR: 1000 V	1000 V	10 V to 1100 V

[a] Minimum increment of 1 V between each subsequent value.

To change the insulation resistance test voltage:

- 1 Press  for more than 1 second to enter the Setup menu.
- 2 Browse to **Menu 8**, select the desired insulation resistance test voltage (**IR: 50 V**, **IR: 100 V**, **IR: 250 V**, **IR: 500 V**, or **IR: 1000 V**) and press  to edit the value.
- 3 Select **U** and use the arrow keys to change the test voltage.
- 4 Press  to save your changes (or press  to discard your changes).
- 5 Press and hold  until the tester restarts to return to normal operation.

## Menu 9








Menu Items	Learn more on:
TEST TIME	<a href="#">“Changing the insulation resistance and earth-bond resistance test period”</a> on page 151
SCAN TIME	<a href="#">“Changing the scan signal dwelling time”</a> on page 151
SCAN STEP	<a href="#">“Changing the scan signal number of steps”</a> on page 152
RAMP STEP	<a href="#">“Changing the ramp signal number of steps”</a> on page 153
TRIP mA	<a href="#">“Changing the trip current value”</a> on page 153

### Changing the insulation resistance and earth-bond resistance test period

This setting is used with insulation resistance tests (see [page 67](#)) or earth-bond resistance measurements (see [page 67](#)). The tester performs the test over the timed period defined in this setting.

Parameter	Range	Default setting
TEST TIME	00:05 to 59:59	01:00

To change the insulation resistance and earth-bond resistance test period:






- 1 Press  for more than 1 second to enter the Setup menu.
- 2 Browse to **Menu 9 > TEST TIME**, and press  to edit the value.
- 3 Use the arrow keys to change the test period.
- 4 Press  to save your changes (or press  to discard your changes).
- 5 Press and hold  until the tester restarts to return to normal operation.

### Changing the scan signal dwelling time

This setting is used with insulation resistance tests (see [page 67](#)). The scan signal will “dwell” in the present step for the length of time stated in the scan dwelling time before incrementing to the next step.

Parameter	Range	Default setting
SCAN TIME	(1 to 99) seconds	10 seconds

To change the scan signal dwelling time:






- 1 Press  for more than 1 second to enter the Setup menu.
- 2 Browse to **Menu 9 > SCAN TIME**, and press  to edit the value.
- 3 Use the arrow keys to change the dwelling time.
- 4 Press  to save your changes (or press  to discard your changes).
- 5 Press and hold  until the tester restarts to return to normal operation.

### Changing the scan signal number of steps

This setting is used with insulation resistance tests (see [page 67](#)). The increment of each step in the scan signal will be the amplitude end position divided by the number of steps. Each step should be set to greater than 10 V and the last step is equal to or less than the test voltage setting.

Parameter	Range	Default setting
SCAN STEP	(1 to 100) steps	5 steps

To change the scan signal number of steps:

- 1 Press  for more than 1 second to enter the Setup menu.
- 2 Browse to **Menu 9 > SCAN STEP**, and press  to edit the value.
- 3 Use the arrow keys to change the number of steps.
- 4 Press  to save your changes (or press  to discard your changes).
- 5 Press and hold  until the tester restarts to return to normal operation.








## Changing the ramp signal number of steps

This setting is used with insulation resistance tests (see [page 67](#)). The increment of each step in the ramp signal will be the amplitude end position divided by the number of steps. For example, a 50 V amplitude end position divided by 100 steps gives an increment of 0.5 V per step.

Parameter	Range	Default setting
RAMP STEP	(1 to 1000) steps	100 steps

To change the ramp signal number of steps:



- 1 Press  for more than 1 second to enter the Setup menu.
- 2 Browse to **Menu 9 > RAMP STEP**, and press  to edit the value.
- 3 Use the arrow keys to change the number of steps.
- 4 Press  to save your changes (or press  to discard your changes).
- 5 Press and hold  until the tester restarts to return to normal operation.

## Changing the trip current value

This setting is used with insulation resistance tests (see [page 67](#)). Set the current value for tripping the insulation resistance test (trip by leakage current/breakdown current).

Parameter	Range	Default setting
TRIP mA	(0.001 to 1.500) mA	1.000 mA

To change the trip current value:

- 1 Press  for more than 1 second to enter the Setup menu.
- 2 Browse to **Menu 9 > TRIP mA**, and press  to edit the value.
- 3 Use the arrow keys to change the trip current.

- 4 Press **T/DAR PI** to save your changes (or press **Lock Esc** to discard your changes).
- 5 Press and hold **⌘** until the tester restarts to return to normal operation.

## Menu 10

**NOTE**

Menu 10 is for model U1461A only.








Menu Items	Learn more on:
T-TYPE	<a href="#">“Changing the thermocouple type”</a> on page 155
T-UNIT	<a href="#">“Changing the temperature unit”</a> on page 155
LPF	<a href="#">“Enabling the low-pass filter”</a> on page 156
mA SCALE	<a href="#">“Changing the % (mA) scale range”</a> on page 157
% & ms	<a href="#">“Enabling the (+ or -) duty cycle and pulse width display”</a> on page 157

## Changing the thermocouple type

This setting is used with temperature measurements (see [page 94](#)). Select a thermocouple type that matches the thermocouple sensor you are using for temperature measurements.

Parameter	Range	Default setting
T-TYPE	Type-J or Type-K	K

To change the thermocouple type:



- 1 Press  for more than 1 second to enter the Setup menu.
- 2 Browse to **Menu 10 > T-TYPE**, and press  to edit the value.
- 3 Use the arrow keys to change the thermocouple type.
- 4 Press  to save your changes (or press  to discard your changes).
- 5 Press and hold  until the tester restarts to return to normal operation.

## Changing the temperature unit

### CAUTION

This Setup item is locked for certain regions. Always set the temperature unit display per the official requirements and in compliance with the National laws of your region.







This setting is used with temperature measurements (see [page 94](#)). Four combinations of displayed temperature unit(s) are available:

- Celsius only: Temperature measured in °C.
- Fahrenheit/Celsius: During temperature measurements, press  to switch between °F and °C.
- Celsius/Fahrenheit: During temperature measurements, press  to switch between °C and °F.
- Fahrenheit only: Temperature measured in °F.


Press and hold  for more than 1 second to unlock this setting.

Parameter	Range	Default setting
T-UNIT	°C, °F/°C, °C/°F, or °F	°C

To change the temperature unit:






- 1 Press  for more than 1 second to enter the Setup menu.
- 2 Browse to **Menu 10 > T-UNIT**. Press and hold  for more than 1 second to unlock this setting, then press  to edit the value.
- 3 Use the arrow keys to change the temperature unit.
- 4 Press  to save your changes (or press  to discard your changes).
- 5 Press and hold  until the tester restarts to return to normal operation.

### Enabling the low-pass filter

This setting is used to enable the low-pass filter to filter out higher frequencies with (AC/DC path) V, mV,  $\mu$ A, or mA measurements. The  symbol is shown during these measurements.

Parameter	Range	Default setting
LPF	ON or OFF	OFF

To enable the filter:






- 1 Press  for more than 1 second to enter the Setup menu.
- 2 Browse to **Menu 10 > LPF**, and press  to edit the value.
- 3 Use the arrow keys to enable the filter.
- 4 Press  to save your changes (or press  to discard your changes).
- 5 Press and hold  until the tester restarts to return to normal operation.

## Changing the % (mA) scale range

This setting is used with % (mA) scale current measurements (see [page 78](#)). The tester converts DC current measurements to a percentage scale readout of 0% to 100% based on the selected range in this menu. For example, a 25% readout represents a DC current of 8 mA on the 4-20 mA % scale, or a DC current of 5 mA on the 0-20 mA % scale.

Parameter	Range	Default setting
mA SCALE	- 4-20 mA or 0-20 mA - D(isable) or E(nable)	4-20 mA-D

To change the % (mA) scale range:



- 1 Press  for more than 1 second to enter the Setup menu.
- 2 Browse to **Menu 10 > mA SCALE**, and press  to edit the value.
- 3 Use the arrow keys to change the % scale range. Select **D** to disable the mA scale readout.
- 4 Press  to save your changes (or press  to discard your changes).
- 5 Press and hold  until the tester restarts to return to normal operation.

## Enabling the (+ or -) duty cycle and pulse width display

This setting is used with frequency measurements (see [page 79](#)). Enabling this feature will allow you to display (+ or -) duty cycle and pulse width along with frequency for voltage or current measurements.

Parameter	Range	Default setting
% & ms	- +CYCLE or -CYCLE - D(isable) or E(nable)	+CYCLE-D

To enable the duty cycle and pulse width display:

- 1 Press  for more than 1 second to enter the Setup menu.
- 2 Browse to **Menu 10 > % & ms**, and press  to edit the value.

## 4 Setup Options

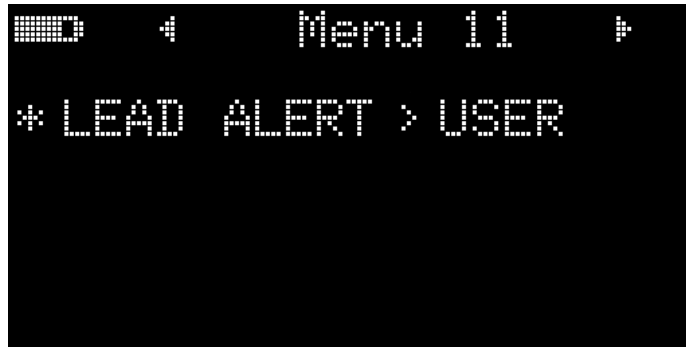
- 3 Use the arrow keys to change the duty cycle and pulse width settings. Select **E** to enable the duty cycle and pulse width display.
- 4 Press **T DAB PI** to save your changes (or press **Lock Hz Esc** to discard your changes).
- 5 Press and hold **⌘** until the tester restarts to return to normal operation.

### Menu 11

#### NOTE

Menu 11 is only for:

- Model U1461A (EBR and  $\mu\text{A}$  mA function only)
- Model U1453A (EBR function only)



#### Menu Items

#### Learn more on:

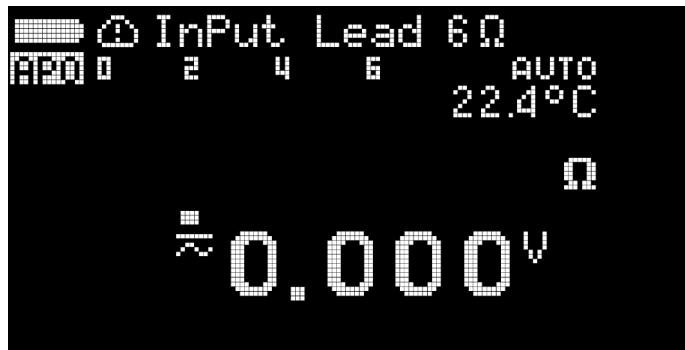
LEAD ALERT

["Changing the lead alert setting"](#) on page 159

## Changing the lead alert setting

This setting is used to trigger an alert for the user to change the test lead connection to the correct terminals before the measurement takes place. You can change the lead alert setting and its duration. The lead alert will sound whenever you switch to a mode that requires the test leads to be repositioned on the tester. This alert will take the form of a beeping sound and caution titled




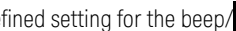

**InPut Lead** that will flash on the top portion of the primary display.














Parameter	Range	Default setting
LEAD ALERT	NONE, USER, or AUTO-NN	AUTO-03 <sup>[a]</sup>

[a] The "03" value corresponds to a warning duration of 3 seconds

There are three available beep settings for the lead alert.

Beep setting	Description
NONE	No beep/  warning
USER	A continuous beep/  warning The beep/  warning will stop when: <ul style="list-style-type: none"> <li>- Any softkey is pressed</li> </ul>
AUTO-NN	A user-defined setting for the beep/  warning <ul style="list-style-type: none"> <li>- You can manually set the beep/warning duration from 01 to 99 seconds</li> </ul> The beep/  warning will stop when: <ul style="list-style-type: none"> <li>- Any softkey is pressed</li> <li>- The duration set by the user is completed</li> </ul>

To change the lead alert settings:

- 1 Press  for more than 1 second to enter the Setup menu.
  - 2 Browse to **Menu 11 > LEAD ALERT**, and press  to edit the lead alert setting.
  - 3 Use the  and  keys to select the desired beep setting.
    - Under the **AUTO-NN** setting, use the  and  keys to navigate to the **NN** section, then use the  and  keys to select the desired lead alert duration.
  - 4 Press  to save your changes (or press  to discard your changes).
- Press and hold  until the meter restarts to return to normal operation.

#### NOTE

After a firmware update, if the LEAD ALERT setting is shown as AUTO-00, restore the setting to the factory default. Refer to **“Resetting the tester’s Setup options”** on page 142 for more details.



# 5 Characteristics and Specifications

For the characteristics and specifications of the U1461A Insulation Multimeter/  
U1453A Insulation Tester, refer to the datasheet at  
<http://literature.cdn.keysight.com/litweb/pdf/5991-4290EN.pdf>.

THIS PAGE HAS BEEN INTENTIONALLY LEFT BLANK.

This information is subject to change without notice. Always refer to the Keysight website for the latest revision.

© Keysight Technologies 2014–2016  
Edition 9, November 18, 2016

Printed in Malaysia

