

Test Equipment Depot

99 Washington St. Melrose MA, 02176

1.800.517.8431 | 781.665.0780 (Fax)

EDSYN INC

ZD500DX ***SOLDAPULLT***[®]

Deluxe Hot Tip Desoldering Station

(self-contained)

- COMPLIES WITH MIL-S-45743E, MIL-STD-2000-1B, WS6536E AND ESD SPEC, DOD-STD-1686, DOD-HDBK-263
- UL listed



Instruction manual

EDSYN^{INC}®

ZD500DX
SOLDAPULLT[®]
Deluxe Hot Tip
Desoldering Station

Contents at a Glance

Page 3 - 4 Features & Specifications

Page 5 Operation

Page 6 - 8 Tip Usage & Replacement

Page 9 Maintenance

Page 10 Trouble Shooting & Maintenance

Page 11 Calibration

Page 11 - 13 Spare Parts List for Power Supply

Page 14 - 15 Spare Parts List for Hand Tool

FEATURES

POWER SUPPLY



Static Safe

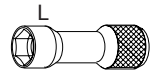
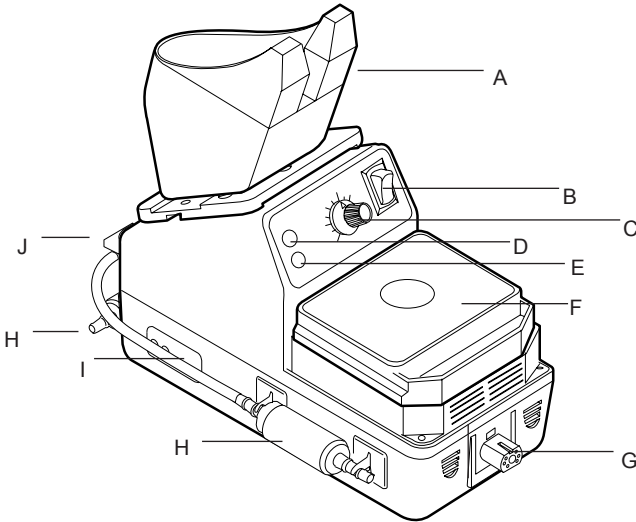

- A) Tool Pod, equipped with micro-switch to activate pump.
- B) Power Switch, to activate WorkStation.
- C) Temp. Control Knob
- D) Pump LED
- E) Heater LED
- F) **SH232** Sponge Holder, with cleaning sponge.
- G) Power output, 24V, controlled
- H) **AF110** Filter, (note flow direction)
- I) External Calibration
- J) Pump
- K) **WT623** Tip Wrench
- L) **WT619** Tip Wrench

SPECIFICATIONS

- 115V, 60 Hz, 150W Power Supply
- 24V, 50/60 Hz, 70W Hand Tool
- Weight; **Power Supply**: 5 lbs. 12 ozs. (2.6 kg)
Hand Tool: 11 ozs. (312 g)
- Temperature range of 400°F to 800°F (205°C-425°C)
- Voltage leakage from tip to ground, less than 2 MV
- Tip to ground resistance, less than 2 ohms
- COMPLIES WITH MIL-S-45743E, DOD-STD-2000-1B, WS-6536E and ESD SPEC, DOD-STD-1686, DOD-HDBK-263

FEATURES

HOT TIP DESOLDERING TOOL



ESD Safe

HT500/-1/-2 *SOLDAPULLT*® Hot Tip Desoldering Tool

- A) Head Assembly- Includes the primary filtering system and solder debris chamber.
- B) Hot Tip Desoldering Tip- Wide range of desoldering Tips applicable.
- C) Head Shaft- Allows 4-point rotation of Head Assembly.
- D) Trigger- Activates vacuum suction.
- E) Vacuum Hose- Low Static silicone hose. Connects to vacuum source.
- F) Connector- To 24 V controlled output.



(for HT500)



(for HT500-2)



F (for HT500-1)



E

- G) Cleaning Shaft- For cleaning Desoldering Tip orifice: .05 (1.3 mm) and .025 (0.6 mm)

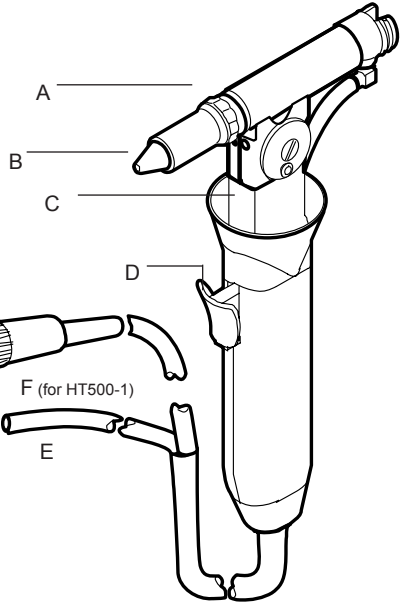

OPTIONS

FC641 Large Filter Cartridge Assembly
Replaces FC640. For use in applications that require heavy use, or where No-Clean solder/flux is used at high temperature.

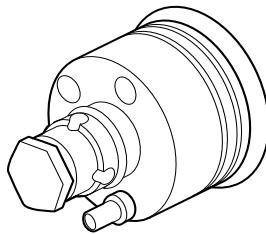

PA233 Dovetail Extension Bracket allows you to install additional Tool Pods.

1. Insert nut into the slot of adapter plate on both sides.
2. Screw PA233 on the adapter plate.

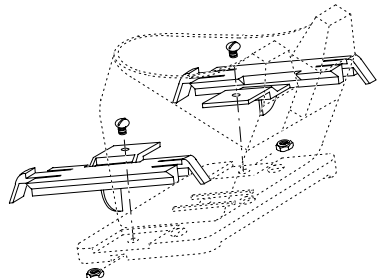

OPERATION

1. Connect HT500 to 24V power supply and vacuum source.
2. Press trigger to activate vacuum.
3. Always clean the Tip with wet sponge and always re-tin (add fresh solder) during and after each operation.

NOTE: When Tip orifice is blocked, use a correct size Cleaning Shaft while pressing the Trigger to clear the obstruction.

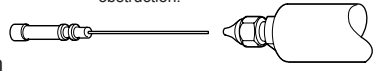

CS468 is .05 in. dia.
CS468-1 is .025 in. dia.

ADJUSTMENTS

The HT500 Head assembly can be adjusted into varying positions to suit the operator.



While Tool is in the Pod, push handle down and twist handle until it locks into 1 of it's 4 positions. Twisting counter-clockwise will permit a 180° turn. Twisting clockwise will permit a 90° turn.

Note: Head Assembly does not make a full 360° turn

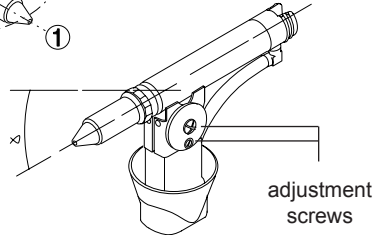
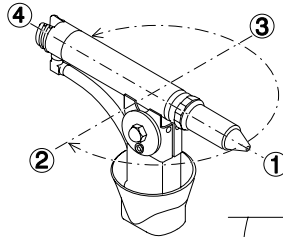

To tilt the Head assembly, loosen (2) Adjustment Screws. Tilt the Head assembly to desired position. Retighten Screws.

AIR FLOW DIRECTION

Hoses must be clean and not kinked or cracked

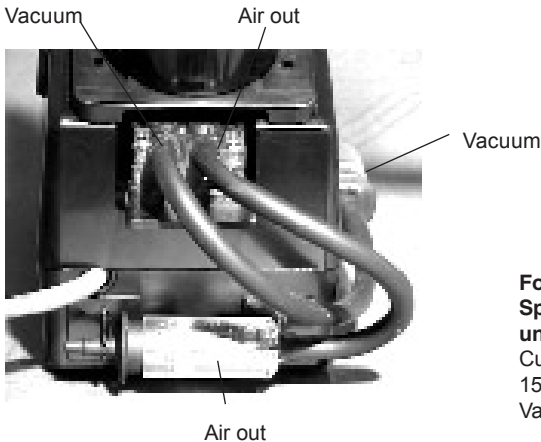

For Factory repair:
Specify the problem and ship the unit to EDSYN INC.
Customer Service
15958 Arminta Street
Van Nuys, CA 91406-1896

DESOLDERING POINTERS

1. When desoldering small holes on flat areas, tilt Tool to allow adequate air flow to lift solder into chamber.

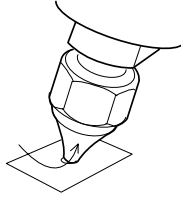

2. When using SMD Tips, heat up the connections by positioning the Tool perpendicularly. When solder melts tilt the Tool and depress trigger. (SMD Tips are recommended for HT500 using external vacuum).

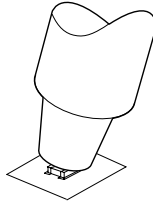

3. Extra-heavy duty desoldering on a multi-layered board is done by using a Heavy Duty Desoldering Tip and a Hi-Heat Soldering Tip simultaneously. Although pre-heating of the circuit board will speed up the process, it is not always necessary.

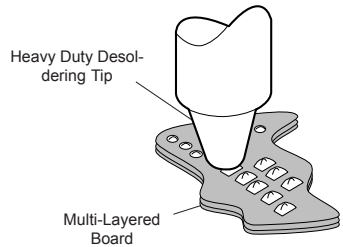

REPLACING DESOLDERING TIPS

1. Remove RS383. Use WT619.
2. Replace Tip and install new Tip.

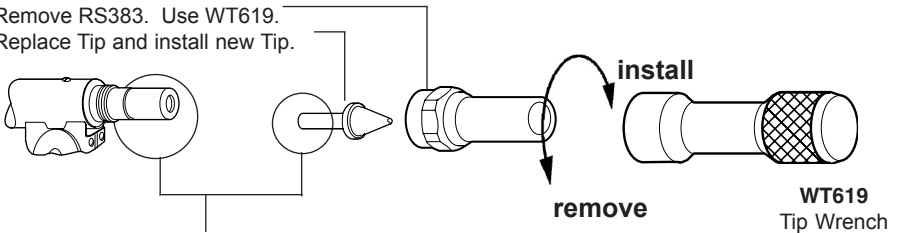

3. Apply **AN112** (in tube) or **AN122** (in syringe) Anti-Seize Compound before assembling.

INSPECT DAILY

4. Install **RS383**.

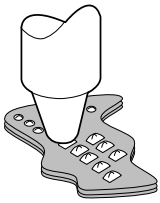

Hot Tip Desoldering Tips

Fractional dimensions are approx.

Extra-heavy duty desoldering on a multi-layered board is done by using a **Medium Life Desoldering Tip**.

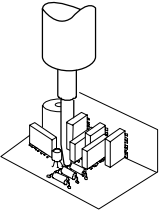

To reach deep, dense and compact areas, use a Long Funnel tip

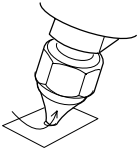

When using a **Replacement Desoldering Tip** to desolder small holes on flat areas, tilt Tool to allow adequate air flow to lift solder into chamber.

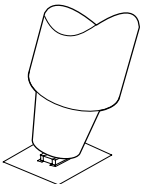

When using **SMD Tips**, heat up the connections by positioning the Tool perpendicularly. When solder melts, tilt the Tool and depress trigger.

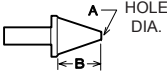
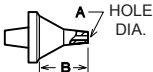
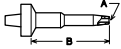
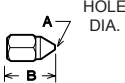
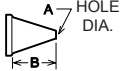
DESCRIPTION	PART NO.	HOLE DIAMETER			B		
		in.	in.	mm	in.	in.	mm
Standard Tip (High Heat Transfer) 	ZD12	.03	1/32	0.8	.50	1/2	12.7
	ZD13	.04	3/64	1.0			
	ZD14	.06	1/16	1.5			
	ZD18	.07	5/64	1.8			
	ZD19	.12	1/8	3.2			
Funnel 	ZD107	.02	1/64	0.5	.48	31/64	12.2
	ZD112	.03	1/32	0.8			
	ZD113	.04	3/64	1.0			
	ZD118	.07	5/64	1.8			
Long Funnel 	ZD111	.03	1/32	.08	1.22	17/32	31
	ZD115	.07	5/64	1.8			
Replacement* 	ZD25	.03	1/32	0.8	.39	32/64	9.9
	ZD26	.04	3/64	1.0			
	ZD27	.07	5/64	1.7			
SMD** (FOR ZD505/905 series) 	ZD57	.10	7/64	2.5	.55	9/16	13.9
	ZD58	.13	1/8	3.2			
	ZD60	.15	5/32	3.8			
	ZD61	.25	1/4	4.5			

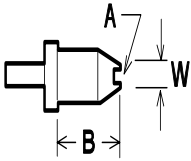

Hot Tip Desoldering Tip

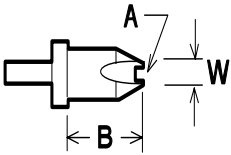

Surface Sweep Tips removes excess solder on pads for flatter surface, prior to SMD remounting.

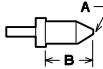

Side Sweep Tips allows removal of solder from the component side of the board.

DESCRIPTION	PART NO.	HOLE DIAMETER			B		
		in.	in.	mm	in.	in.	mm
Economy**  HOLE DIA.	ZD28	.03	1/32	.08	.30	5/16	7.6
	ZD29	.04	3/64	1.0			
	ZD30	.06	1/16	1.5			
Surface Sweep**  Hole Dia. = .06 in.	ZD70	W					
		in.	in.	mm			
Side Sweep**  Hole Dia. = .06 in.	ZD71	.08	3/32	2.0			

*Tin New Iron Tips at Low Temperature before using.

**Non-Plated Alloy

Hot Tip set-up

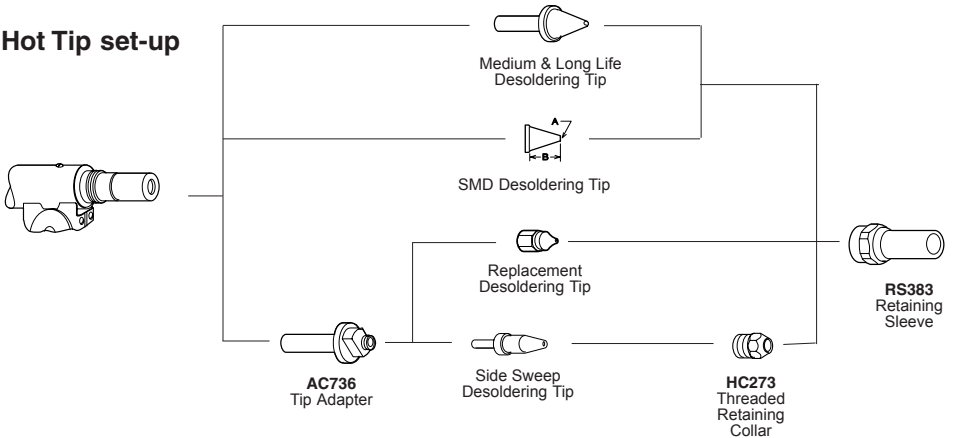

Heater Set-up

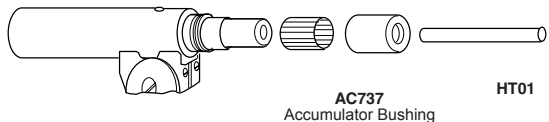

DAILY MAINTENANCE

- Remove and inspect Tip and Heater Assy.
- Inspect all Filters
- Remove solder debri from Desoldering Head Housing

WEEKLY MAINTENANCE

- Inspect Valve Assy.
- Inspect all O-Rings and Seals

TO REPLACE FILTER & O-RING INSIDE DESOLDERING HEAD ASSY.

1. Pull out FC639 from Housing.
2. Unscrew SC525 from FC639 to remove AF625.
3. Insert new AF625 inside SC525 and screw back on.
4. Clean and apply OL111 on OS731 & OS132 O-Ring.

Ⓒ - Clean

Ⓓ - Replace

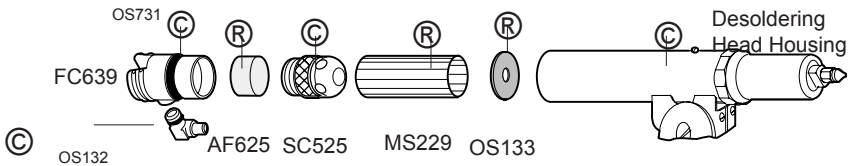

OPTIONAL FC641

Large Filter Cartridge Assembly

1. Pull out FC641 from Housing.
2. Unscrew FC641 remove old AF041.
3. Insert new AF641 inside FC641 and screw back together.
4. Clean and apply OL111 on OS731 & OS132 O-Ring.

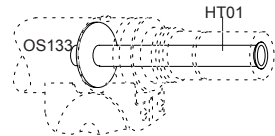
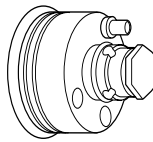

When installing OS133, the HT01 should go thru the OS133.

TO REPLACE O- RINGS INSIDE VALVE ASSEMBLY

- a) Unscrew Lock Nut at the end of the **HT500** Handle.
- b) Remove Handle Cover.
- c) Slide out Valve Assembly while placing your finger over the Spring Seat. **BE CAREFUL NOT TO LET THE SPRING AND THE SPRING SEAT SHOOT OUT FROM THE HOUSING**
- d) Clean all parts with alcohol only.
- e) Replace **OS730** O-Ring Set (set of 3).

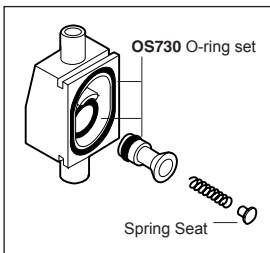
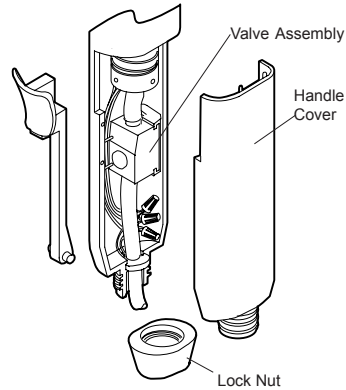

CAUTION: Make sure the wires are not pinched by Valve Assembly.

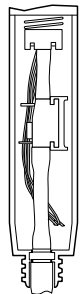

TROUBLE SHOOT-

Problems that occur aside from those listed below should be handled by our factory technicians.

Symptoms	Cause	Remedy
Pump won't run	a) Pump micro switch is stuck. b) Vacuum inside hose (normal)	a) Use a pair of tweezers to release the switch. b) Squeeze trigger to release vacuum.
Pump running but weak or no vacuum generated.	a) Loose connections between joints or connectors. b) Dirty filters. c) Leaky or sticky valve. d) Wrong hose connection. e) Broken pump diaphragm.	a) Make sure all connections are tight. b) Inspect and clean all filters. Replace elements if needed. c) Clean parts and replace O-Rings if needed . d) HT500 Hose should be connected to AF110 . e) Ship back to factory
No power	Blown fuse	Replace fuse. See spare parts list

FUSE REPLACEMENT

3.15A fuse inside

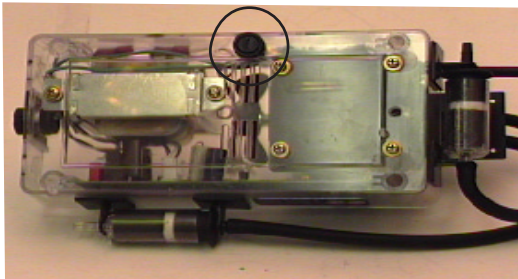

SPONGE MAINTENANCE

Replace RS199 Cleaning Sponge

Pour water on **RS199** to moisten it completely.
DO NOT OVERFILL.

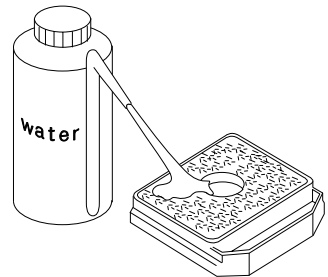

FILTER MAINTENANCE



Filters should be kept clean

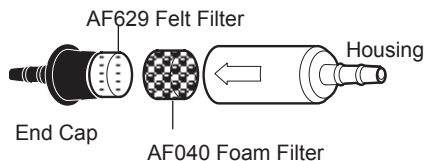

Tip Wrench can be use to remove filter cap.

CALIBRATION

AIR MOVEMENT WILL AFFECT THE TEMPERATURE READING.
WORK IN AN AREA WHERE THIS IS MINIMAL.

1. Using a clean Tip, turn on power and set Temperature Control Knob to approx. 500°F (260°C). Allow Tip to warm up.
2. Tin the tip properly and place center of the thermo-couple wire on tip.
3. Apply a small amount of solder on the center of the thermo-couple wire, to form a good contact between the tip and the thermo-couple wire.
4. Set Temperature Control Knob to 400°F (205°C).
5. Adjust **LO**-Temp. Calibration Pot so the Meter will read 400°F (205°C).
6. Set Temperature Control Knob to 800°F (427°C).
7. Adjust **HI**-Temp. Calibration Pot so the Meter will read 800°F (427°C).

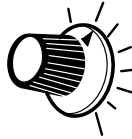

Temperature Control Knob



Calibration Pot

ZD500DX Spare Parts List

ITEM NO.	PART NO.	DESCRIPTION	QTY REQ'D
44	SR011	Screw, Round Head Phillips, 6-18 x 5/8	4
45	SR012	Bump-Ons	4
46	SR026	Power Cord Only	1
47	WT623	Tip Wrench, Dual Open End, 1/4" & 3/4"	1
48	SR416	Holder, Tip Wrench Hanger	1
49	SR776	Fan	1

See next page for illustration

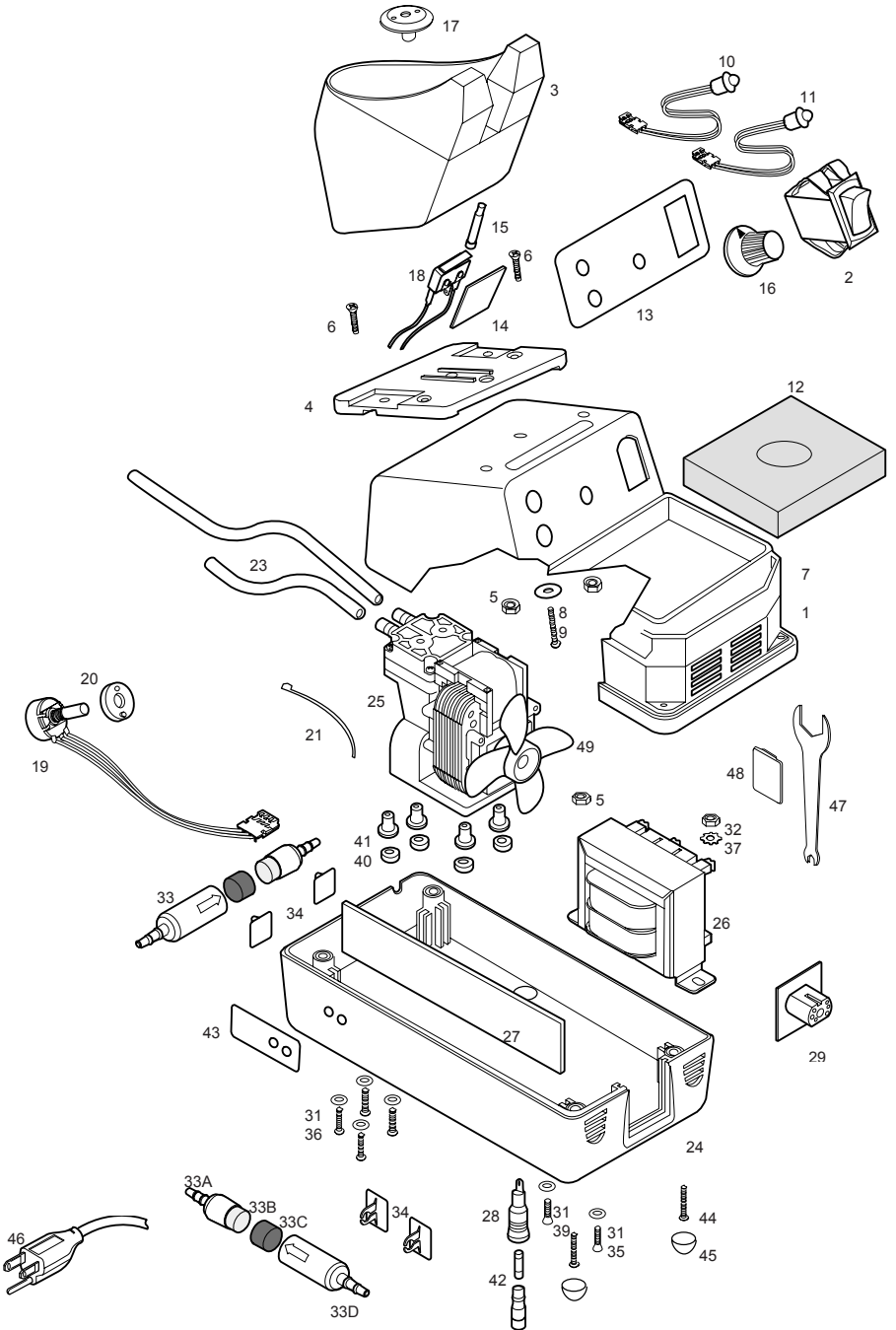

ITEM NO.	PART NO.	DESCRIPTION	QTY REQ'D
1	SR566	Top Cover, Power Supply	1
2	SR065	Power Switch, 120V	1
3	SR073	Tool Holder	1
4	SR817	Adapter plate	1
5	SR467	Nut, Square Cone	3
6	SR367	Screw, Flat Head Phillips, 6-32 x 5/8	2
7	SH232	Sponge Holder	1
8	SR137	Washer, #8	1
9	SR009	Screw, Pan Head Slotted, 8-32 x 7/8	1
10	SR759	LED Assy. Yellow, for pump	1
11	SR573	LED Assy. Green	1
12	RS199	Cleaning Sponge	1
13	SR567	Label, Front Panel	1
14	SR115	Retainer Plate for Micro Switch	1
15	SR114	Push Rod for Micro Switch	1
16	SR045	Knob, Temperature Control	1
17	SR112	Flange, Retainer for Tool Pod	1
18	SR568	Micro Switch Assy.	1
19	SR243	Potentiometer Assy.	1
20	SR255	Spacer, for Potentiometer Assy.	1
21	SR050	Cable Tie	1
23	HL603	Hose, Low Static Silicone, 3/16 ID. (sold per foot)	2@
		7" and 10"	
24	SR484	Bottom Base	1
25	SR535	Pump / Motor Assy. 120V	1
26	SR138	Transformer, Dual Primary, 24V output	1
27	15242W70	Circuit Board	1
28	SR569	Fuse Holder, Panel Mount	1
29	SR711	Connector Assy.	1
31	SR016	Washer, #6	6
32	SR017	Nut, 6-32	3
33	AF110	Filter, In-Line Vacuum	2
33A	SR266	End Cap	2
33B	AF629	Felt Filter (set of 10)	2
33C	AF040	Foam Filter (set of 10)	2
33D	SR533	Barrel, Clear, for AF110	2
34	SR439	Holder, Clip	4
35	SR561	Screw, Round Head Phillips, 6-32 x 3/4	1
36	SR468	Screw, Round head Phillips, 6-32 x 7/8	4
37	SR139	Washer, Star	4
39	SR144	Screw, Round Head Slotted, 6-32 x 1/2	1
40	SR469	Spacer, for Pump Mounting	4
41	SR470	Well Nuts, for Pump Mounting	4
42	SR563	Fuse, 3.15A	1
43	SR310	Label, Calibration, Left Rear	1

**HT500/-1 SOLDAPULLT HOT TIP
DESOLDERING TOOL
SPARE PARTS LIST**

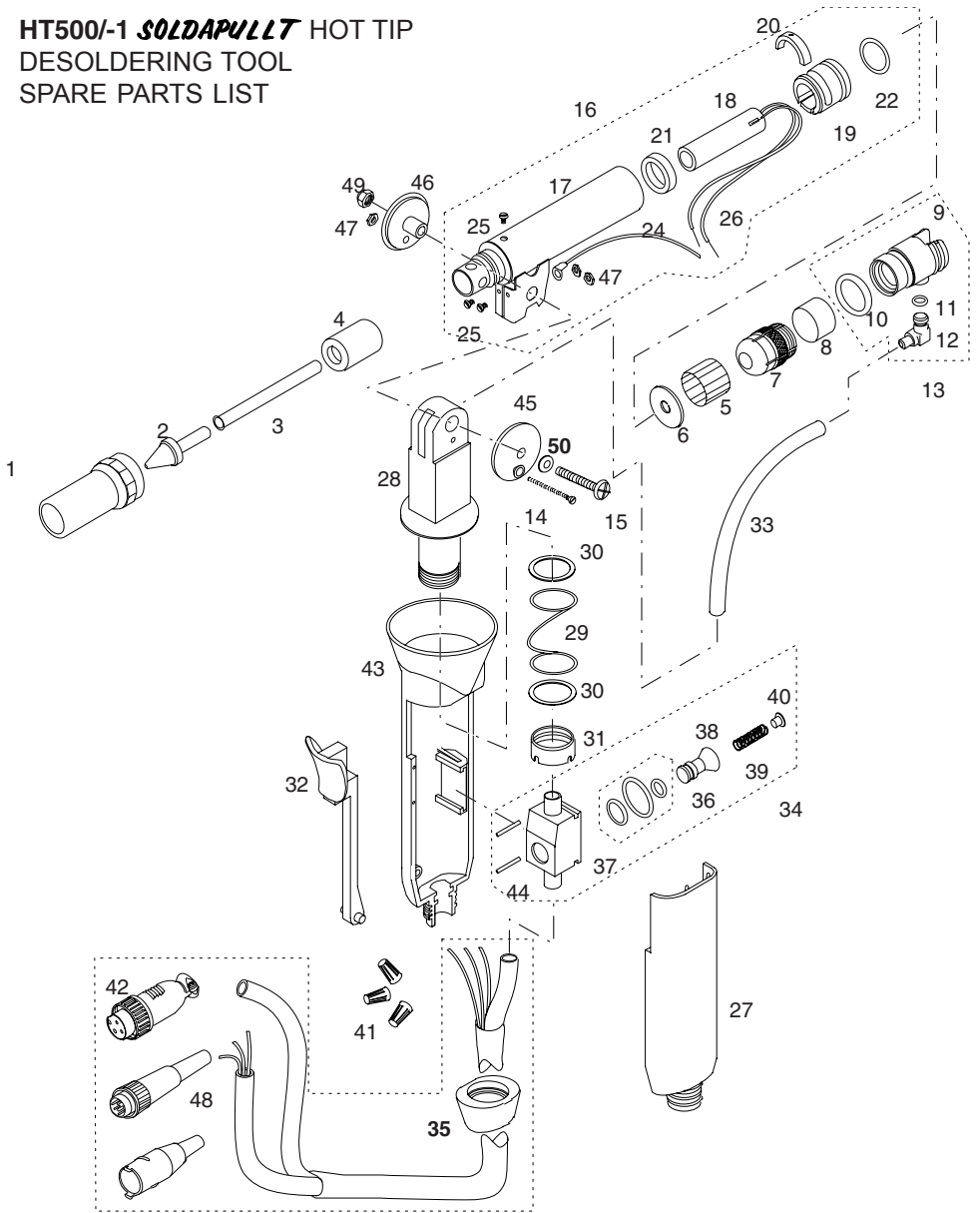

ITEM NO.	PART NO.	DESCRIPTION	QTY REQ'D
1	RS383	Retaining Sleeve	1
2	ZD13	Hot Tip Desoldering Tip	1
3	HT01	Hot Tube	1
4	AC737	Accumulator Bushing	1
5	MS229	Mica Sheet	1
6	OS133	Silicone Washer	1
7	SC525	Solder Cone	1

ITEM NO.	PART NO.	DESCRIPTION	QTY REQ'D
8	AF625	Felt Filter	1
9	SR148	Housing for End Cap	1
10	OS731	O-Ring for End Cap	1
11	OS132	O-Ring for End Cap Elbow Connector	1
12	SR147	Connector for End Cap	1
13	FC639	End Cap	1
14	SR008	Flat Head Slotted Screw for Index Flange	1
15	SR168	Pan Head Phillip Screw for adjusting Desoldering Head Assy.	1
16	HT500H	Desoldering Head Assembly- Repairable by EDSYN Customer Service Dept.	1
17	SR136	Desoldering Head Housing	1
18	SR120	Heater Element	1
19	SR117	Heater Element Bushing (O-Ring included)	1
20	SR118	Retaining Key for Heater Element Bushing	1
21	SR119	Teflon Spacer for Heater Element	1
22	OS731	O-Ring for Heater Bushing	1
24	SR121	Grounding Wire	1
25	SR122	Screw, 2-56 x 1/8 Pan Head Slotted	3
26	SR145	Sleeving, Braided Fiberglass	2
27	SR004	Handle Cover	1
28	SR124	Head Shaft	1
29	SR125	Spring for Head Shaft	1
30	SR126	Washer, Nylon	2
31	SR127	Retaining Nut for Head Shaft	1
32	SR128	Trigger	1
33	HL603	Hose, Low Static Silicone, 3/16" I.D.	5"
34	SR335	Valve Assy.	1
35	SR393	Nut, Retaining, for Handle	1
36	OS730	O-Ring Set (Three O-Rings)	1 set
37	SR129	Valve Housing	1
38	SR130	Poppet (O-Ring Included)	1
39	SR131	Return Spring for Poppet	1
40	SR132	Seat for Return Spring	1
41	SR133	Wire Nuts	3
42		SR134 Hose and Wiring Assembly for HT500	1
		SR565 for HT500-1 SR635 for HT500-2	
43	SR123	Handle Base	1
44	SR143	Wire Guide, Nylon, 3/8" Length	2
45	SR005	Index Flange (Screw Side)	1
46	SR006	Index Flange (Nut Side)	1
47	SR007	Nut, Hex, 2-56 thread	3
48		SR135 Connector for HT500	1
		SR353 for HT500-1 SR633 for HT500-2	
49	SR170	Cap Nut, Hex #8-32 x 5/16"	1
50	SR169	Washer, Flat, 1/16" thick	1

ZD500DX instruction manual

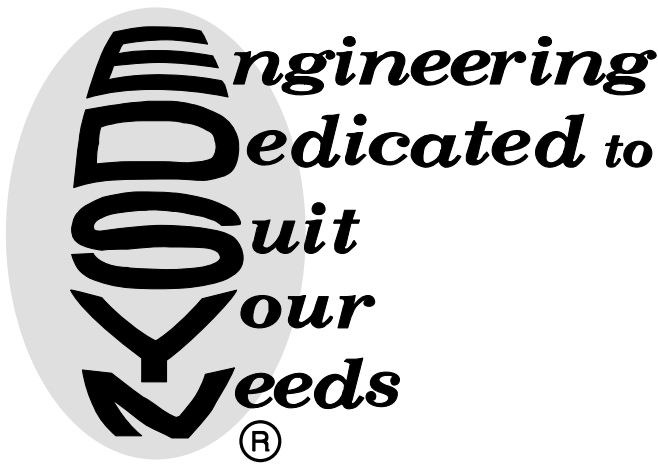

ALL RIGHTS RESERVED.

NO PART OF THIS PUBLICATION INCLUDING THE INDIVIDUAL ICONS
MAY BE REPRODUCED OR UTILIZED IN ANY FORM OR BY ANY MEANS
WITHOUT THE PERMISSION OF EDSYN, INC.

THE NAMES LONER, SOLDAPULLT, SOLDAVAC, ATMOSCOPE
AUTO-VAC, IDLE-REST, OCTAVAC AND KLATCH
ARE REGISTERED TRADEMARKS OF EDSYN, INC.



Intellectual
Property

MOST PRODUCTS ARE COVERED BY U.S. AND
FOREIGN PATENTS AND PENDING APPLICATIONS.

DESIGN, COLOR AND MATERIALS
SUBJECT TO CHANGE WITHOUT NOTICE.

TIP STYLE ON SOLDERING, DESOLDERING AND HOT AIR TOOLS MAY VARY.

PRINTED IN U.S.A.



EDSYN INC.®

...the power of precision



Test Equipment Depot

99 Washington St. Melrose MA, 02176

1.800.517.8431 | 781.665.0780 (Fax)

▶ Visit us at www.TestEquipmentDepot.com